

ZENMUSE X7

User Manual V1.0

2017.11

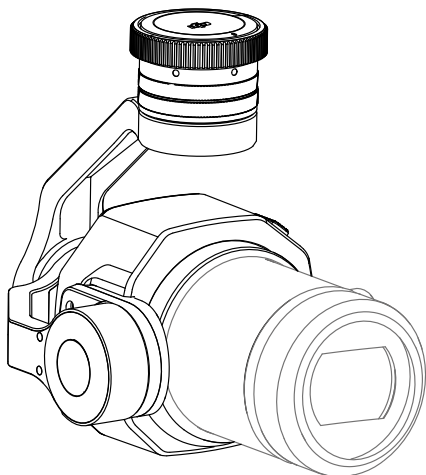

Searching for Keywords

Search for keywords such as “battery” and “install” to find a topic. If you are using Adobe Acrobat Reader to read this document, press Ctrl+F on Windows or Command+F on Mac to begin a search.

Navigating to a Topic

View a complete list of topics in the table of contents. Click on a topic to navigate to that section.

Printing this Document

This document supports high resolution printing.

Read Before the First Flight

Legends

 Warning

 Important

 Hints and Tips

 Reference

Using this manual

Read the following documents before using the ZENMUSE™ X7:

1. Zenmuse X7 Quick Start Guide
2. DJI DL/DL-S Lens Quick Start Guide
3. Zenmuse X7 User Manual

We recommend reading the Zenmuse X7 Quick Start Guide, especially its Disclaimer and Safety sections, to get familiar with all parts of the Zenmuse X7. And then refer to this Zenmuse User Manual for detailed information.

Getting more information

Visit the following webpage for more information about the Zenmuse X7.

<http://www.dji.com/zenmuse-x7>

Contents

Read Before the First Flight	2
Legends	2
Using this manual	2
Getting more information	2
Product Profile	4
Introduction	4
In the Box	5
Overview	5
Zenmuse X7	5
DJI DL/DL-S Lens (Optional)	6
Getting Started	6
Read the information below before setting up your Zenmuse X7	6
Installing a Camera Lens	7
Mechanical Range	9
Compatible Lenses	10
MTF	10
Lens Specifications	11
Mounting Filters/Protector	11
Camera Controls	12
DJI GO 4 App	13
Launching the DJI GO 4 app	13
Camera Interface	13
Video/Photo Settings Page	14
EI Mode	15
Color Waveform	15
Advanced Settings	16
Exposure Mode	16
Video/Photo Styles	17
White Balance	17
Camera Maintenance	17
Update Firmware	18
Specifications	19

Product Profile

Introduction

The Zenmuse X7 is the world's first Super 35 mm camera made for aerial cinematography and is capable of recording videos at 6K 30fps (full FOV), 3.9K 59.97fps (narrow FOV) in CinemaDNG and at 5.2K 30fps (full FOV) in Apple ProRes formats. It can also shoot 24 MP stills. A variety of shooting modes including Single Shot, Burst Shooting (3/5/7/10 shots), and Interval Shooting, provide even more creative options.

When using DJI CINESSD, the X7 can record lossless videos in both CinemaDNG and Apple ProRes formats with a maximum bitrate of 4.44 Gbps, all while capturing DNG stills at 20fps continuously.

The X7 also introduces the DL-Mount, the world's first integrated aerial lens mount that allows switching between four available prime lenses quickly. Please refer to the [Supported Lenses](#) section for more information on lenses. For seamless editing, a new DJI Cinema Color System preserves accurate colors for easier post-processing. These latest innovations allow filmmakers to reach new heights and capture scenes as they imagine them.

The pixel size of the sensor reaches 3.91 μm , and the diagonal length of the sensor is 26.6 mm when recording. A sensor this size offers a higher sensitivity to light and 14 stops of dynamic range — more extensive than the 12.8 stops featured on the Zenmuse X5S.

When mounted on the Inspire 2, the 3-axis gimbal provides a stable platform for the camera to get clear shots even during rapid maneuvering. The gimbal tilts the camera across a -125° to $+40^\circ$ pitch angle and pans $\pm 300^\circ$ in both directions. Live HD video from the camera is streamed to the DJI GO 4 app.

In the Box

Check that all of the following items are in your package. If any item is missing, please contact DJI or your local dealer.

Zenmuse X7* × 1

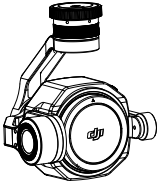

Carrying Box × 1

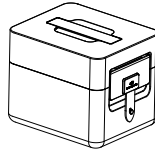

* Lenses are not included with the Zenmuse X7. Please visit the official DJI Online Store to purchase a compatible lens.

Overview

Zenmuse X7

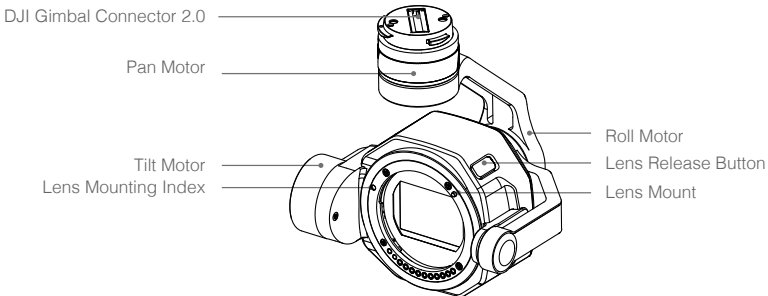

DJI DL/DL-S Lens (Optional)

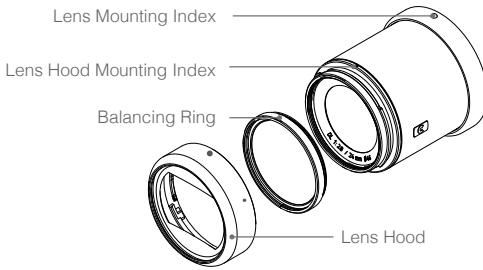

Example: DJI DL 24mm F2.8 LS ASPH Lens

Getting Started

Read the information below before setting up your Zenmuse X7

Supported Devices

The Zenmuse X7 can be attached to the following device, and will be compatible with other DJI devices in the future:

DJI Inspire 2 series

Supported Lenses for the Zenmuse X7

The Zenmuse X7 currently supports the following lenses, and will support additional lenses in the future.

DJI DL-S 16mm F2.8 ND ASPH

DJI DL 24mm F2.8 LS ASPH

DJI DL 35mm F2.8 LS ASPH

DJI DL 50mm F2.8 LS ASPH

-
-  • For sharp and clear videos, the shutter speed should be no shorter than 1/500s when using a focal length no longer than 35 mm; and a shutter speed no shorter than 1/600s when using a focal length longer than 35 mm.
-

Installing a Camera Lens

Required Lens Accessories

The DL-mount of Zenmuse X7 supports the DJI DL/DL-S Lens series. The performance of the gimbal is affected by the weight of the camera. The balancing ring, lens hood, and lens protector are included in the DJI DL/DL-S Lens.

When mounting the lens accessories, the following instructions must be strictly adhered to:

1. The lens protector is used to protect the lens during transportation, storage, and use, and does not reduce the amount of light coming into the sensor. It is recommended to use it in severe shooting environments to prolong the service life of the lens. However, there might be lens flare in some situations when the protector is in use.
2. Non-official filters are supported for both DL/DL-S lenses. Please use a filter with a diameter of 46 mm, a weight between 10 to 12 g, and a thickness of 4.4 mm (thread mount excluded). To balance the gimbal weight, the following combination is recommended when mounting the lens onto the Zenmuse X7:
 - a. Lens hood + lens protector
 - b. Lens hood + balancing ring
 - c. Lens hood + ND filter
 - d. Two ND filters

Jump to page 11 to see how to [Mounting Filters/Protector](#).

Attaching a Lens

Please follow the steps below to mount a lens to the camera body. The following instructions use the DJI DL 24mm F/2.8 LS ASPH lens as an example.

1. Remove the camera body cap.
2. Remove the lens cap and rear cap.

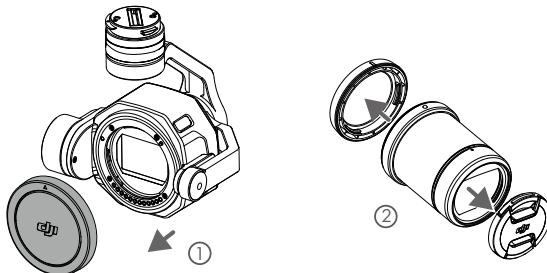

- Align the two lens mounting indexes on the camera body and camera lens, and insert the camera lens into the camera body.
- Rotate the camera lens clockwise until you hear a click.

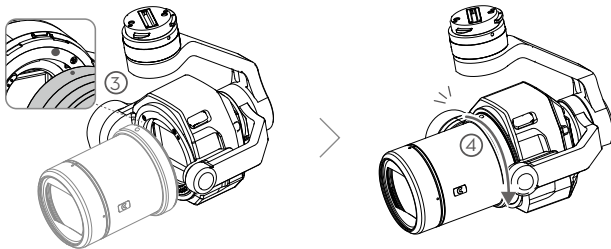

- Rotate the camera lens counter-clockwise after mounting the lens to make sure the lens is firmly attached.

-
- ⚠**
- Mount the camera lens with the lens mount facing downward to prevent dust from entering the sensor, which may negatively affect its performance. DO NOT touch the sensor unit if you find dust or impurities on it, and refer to [Camera Maintenance](#) on how to clean the sensor unit.
 - DO NOT press the lens release button while attaching the lens.
-

Mounting the Zenmuse X7 to an Aircraft

The following steps show how to mount the Zenmuse X7 to a DJI Inspire 2 drone:

- Remove the gimbal cap from the Zenmuse X7.
- Press the gimbal and camera detach button on the Inspire 2. Rotate the gimbal cap on the Inspire 2 to remove it.
- Align the white dot on the gimbal with the red dot on the Inspire 2 and insert the gimbal.
- Rotate the gimbal lock to the locked position by aligning the red dots.

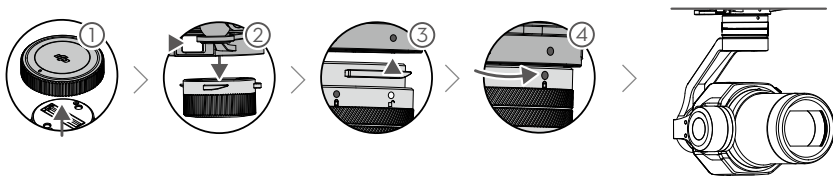

-
- ⚠ • Always ensure that the Gimbal Connector 2.0 on the Inspire 2 is positioned correctly when mounting, otherwise the camera will not mount.
- Remove the Zenmuse X7 by pressing the gimbal and camera detach button on the Inspire 2.
 - Only remove the Zenmuse X7 after powering off the aircraft.
-

Mechanical Range

The 3-axis gimbal provides an incredibly stable and mobile platform for the camera system to capture completely smooth images and videos. The gimbal can tilt the camera up to 165 degrees, pan 300 degrees, and roll 40 degrees in either direction.

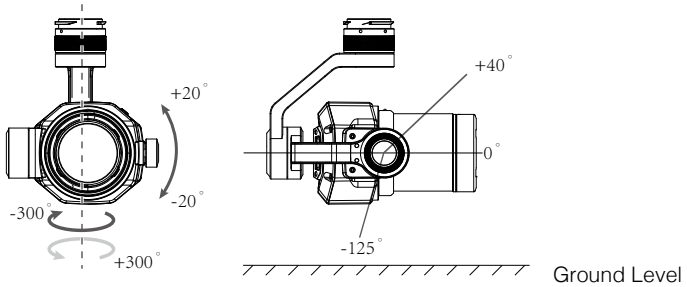

-
- ⚠ • Take off from flat, open ground and protect the gimbal at all times.
-

Compatible Lenses

DJI DL/DL-S Lenses are compatible with the DJI DL-Mount of the Zenmuse X7 (a diameter of 58 mm). When used with the Zenmuse X7, the crop factor is 1.5 for still shooting, and 1.6 for video recording. The DL-S 16 mm F2.8 ND ASPH lens has a built-in ND 4 filter and it can record video of Super 35 mm size. The image circles of the DJI 24mm, 35mm, and 50mm are larger than the sensor size of Zenmuse X7, and are capable of creating professional video of film quality in S35 mode. Their built-in leaf shutter supports the shutter speed of up to 1/1000s, which can efficiently avoid video lag during high speed shooting.

MTF

An MTF chart is used to measure the ability of a lens to reproduce contrast and resolve details. Low spatial frequencies reflect overall contrast, and high spatial frequencies reflect detail resolution. Both are measured in LP/mm. Image Height indicates the distance of a given point on the lens from the center of the sensor. MTF 100% indicates perfect performance.

DL-S 16mm F2.8 ND ASPH

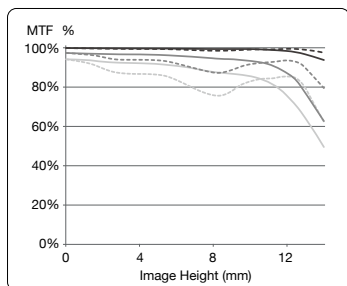

DL 24mm F2.8 LS ASPH

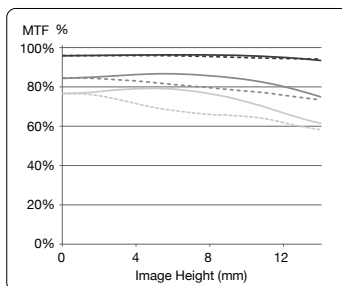

DL 35mm F2.8 LS ASPH

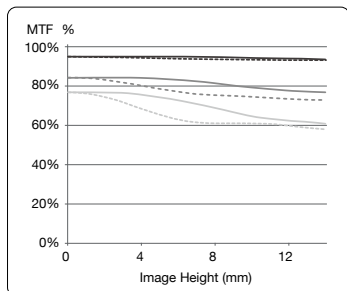

DL 50mm F2.8 LS ASPH

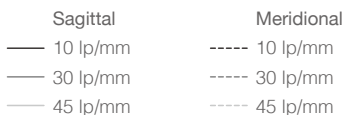
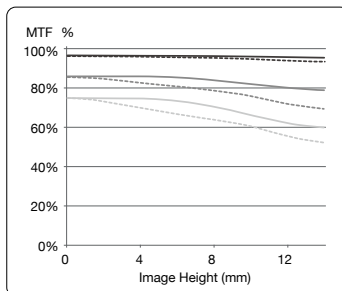

Lens Specifications

Lens		DL 24mm F2.8 LS ASPH	DL 35mm F2.8 LS ASPH	DL 50mm F2.8 LS ASPH	DL-S 16mm F2.8 ND ASPH	
Focal Length		24 mm	35 mm	50 mm	16 mm	
35 mm equivalent (stills)		37 mm	54 mm	77 mm	24 mm	
Aperture Range		F2.8~F16	F2.8~F16	F2.8~F16	F2.8~F16	
FOV*	3:2	23.5×15.7 mm	52.2×36.2°	37.1×25.3°	26.5×17.9°	72.6×52.3°
	17:9	23.5×12.5 mm	52.2×29.2°	37.1×20.3°	26.5×14.3°	72.6×42.7°
		15.4×8.2 mm	35.6×19.4°	24.8×13.4°	17.5×9.4°	51.4×28.8°
	16:9	22.5×12.7 mm	50.2×29.6°	35.6×20.6°	25.4×14.5°	70.2×43.3°
		14.5×8.2 mm	33.6×19.4 °	23.4×13.4°	16.5×9.4°	48.8×28.8°
2.44:1	23.5×9.6 mm	52.2×22.6°	37.1×15.6°	26.5×11.0°	72.6×33.4°	
Close Focus		0.65 m	0.85 m	0.93 m	0.40 m	
Filter Diameter		46 mm	46 mm	46 mm	46 mm	
Elements/Groups/ASPH elements		9 / 8 / 3	9 / 8 / 3	9 / 7 / 2	13 / 12 / 4	
Barrel Dimensions (diameter × length)		∅55.0×71.2 mm (including lens hood)	∅55.0×71.2 mm (including lens hood)	∅55.0×71.2 mm (including lens hood)	∅55.0×69.1 mm (including lens hood)	
Weight		Approx.178 g	Approx.180 g	Approx.182 g	Approx.182 g	



* This table only contains information of the sensor size effective for imaging and the corresponding FOVs in different frame ratios.

Mounting Filters/Protector

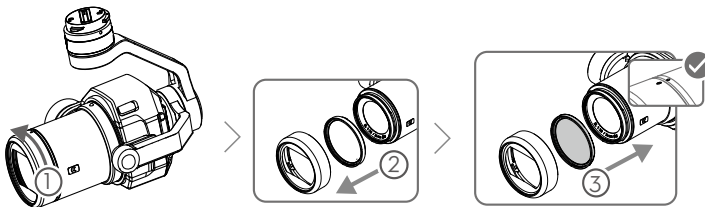
1. Rotate the lens hood to remove it.
2. Rotate the balancing ring to remove it.
3. Mount the new filter (or the new protector) and the lens hood. When mounting the lens hood, first align the small red dot on the lens hood with the red dot on the lens, then rotate the lens hood to align the big red dot with the dot on the lens.



Enabling the Built-in ND Filter of the 16 mm Lens

Launch the DJI GO 4 app and go to the camera page, then tap  >  > ND Filter to enable the built-in ND 4 filter.

Camera Controls

Press the Shutter Button to capture photos or the Record Button to record videos. Adjust the camera's tilt using the left dial. Turn the right dial to adjust camera settings.

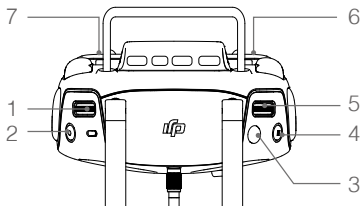

1. Left Dial

Scroll this dial to control tilt the gimbal. Scroll this dial while pressing the C1 to control gimbal yaw; Scroll this dial while pressing C2 to control tilt the FPV camera.

2. Recording Button

Press once to start video recording. Press again to stop recording.

3. Shutter Button

Press to take a photo. If burst mode is selected, the set number of photos will be taken with one press.

4. Intelligent Flight Pause Button

Press once to exit from TapFly, ActiveTrack, and Advanced modes.

5. Right Dial

Press once and then scroll to set camera settings. Re-activate this function after 10s free of operation.

6. C2 Button

Set in DJI GO 4 app.

7. C1 Button

Set in DJI GO 4 app.

DJI GO 4 App

Downloading

Search for “DJI GO 4” in the App Store, or download at www.dji.com.

Launching the DJI GO 4 app

1. Power on the remote controller and the aircraft.
2. Connect the remote controller and your mobile device via a USB cable.

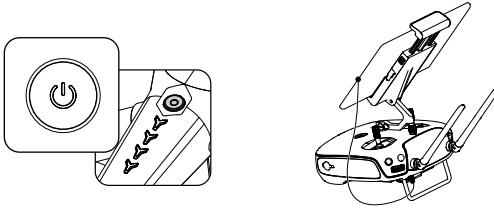

3. Launch the DJI GO 4 app after successful connection, and the live HD video stream will begin.



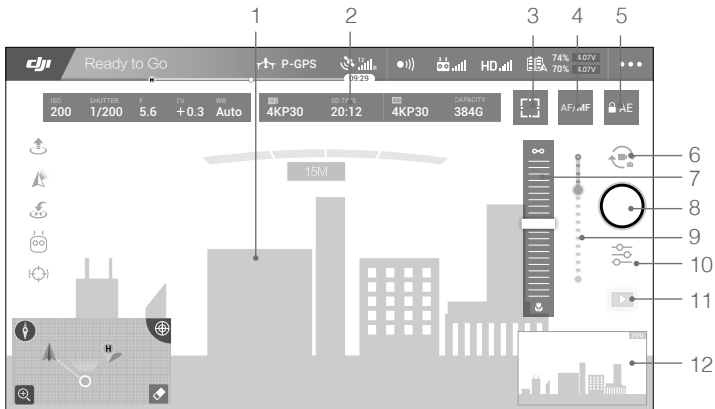

Camera Interface

The touch interface can be used for capturing photos, recording videos and playback. Professional photography configurations are also available.



- | | |
|-------------------------------|---|
| 1. Live HD Video | 7. MF Adjust (in MF mode) |
| 2. Current Camera Settings | 8. Shutter/Record |
| 3. Spot Metering/Focus Switch | 9. Gimbal Slider |
| 4. AF/MF Switch | 10. Photography Configurations and Parameter Settings |
| 5. AE Lock | 11. Playback |
| 6. Shutter/Record Switch | 12. FPV |

Video/Photo Settings Page

Tap the     on the camera page to set Video/Photo parameters.

Video Settings

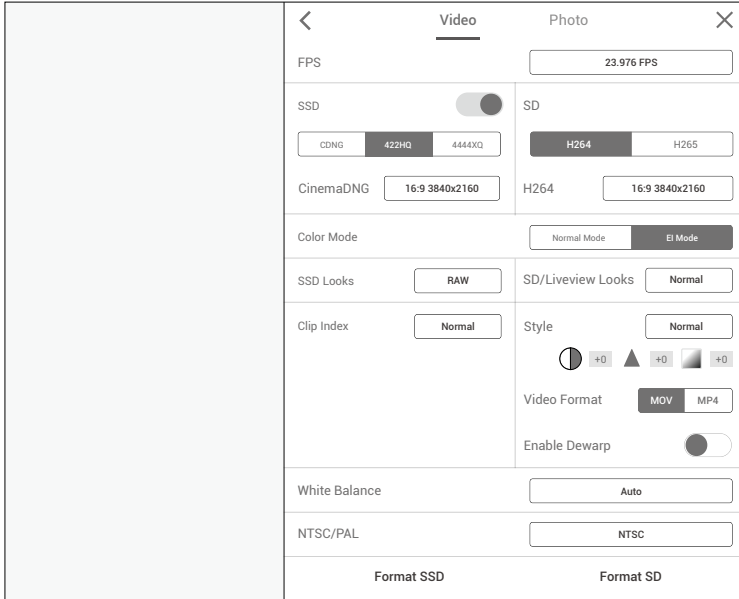

- FPS:** Tap to get the pull-down menu. Different FPSs are available to choose from. Please refer to “Specification” to see the details of the FPS.
- SSD:** Choose to enable or disable CINESSD. To enable the CINESSD, videos can be recorded in CinemaDNG or ProRes formats. The format of CinemaDNG is chosen as an example. After the format is selected, it will be displayed below, and you may choose the desired frame ratio and resolution in the pull-down menu. When the CINESSD is enabled, normal mode and EI mode are available. For a detailed explanation of EI mode, please refer to “EI Mode”.
- SSD Looks:** Normal and CineLike are available. When you choose to record in CinemaDNG format, this column will be in grey, indicating that it cannot be changed and only RAW is supported.
- Clip Index:** Set the name of the video for management.
- SD:** Videos in H.264 and H.265 formats will be stored on the MicroSD card. A MicroSD card is a necessary storage device for the Zenmuse X7. Choose H.264 or H.265 before recording, and then the frame ratio and the resolution in the pull-down menu.
- SD/Liveview Look:** Choose from Normal and D-Cinelike.
- Style:** Includes four video styles, Standard, Landscape, Soft, and Custom.
- White Balance:** Refer to “White Balance” for detailed information.

Photo Setting

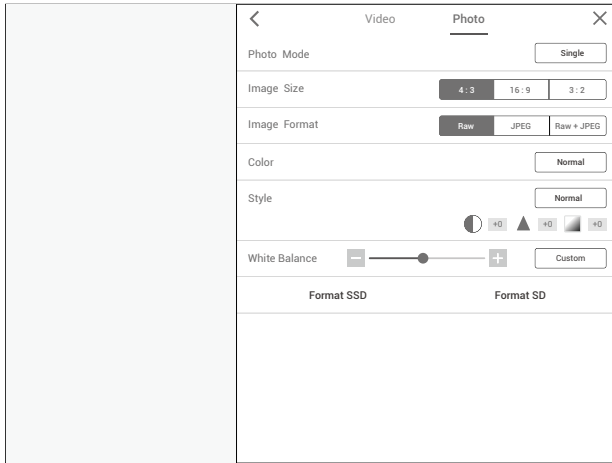



1. **Photo Mode:** Choose Single Shot, Multiple, AEB, Timed Shot or RAW Burst (CINESSD is needed for RAW Burst).
Multiple: Take 3, 5, 7, or 10 shots in a row.
AEB: Take 3 or 5 bracketed frames with $\pm 0.7EV$ steps for exposure compensation.
Timed Shot: Take photos in 2, 3, 5, 7, 10, 15, 20, 30 or 60 second intervals.
RAW Burst: 3/5/7/10/14/ ∞ frames, up to 20fps when using RAW burst, but the exact photo numbers is restricted by storage card capacity and battery power level.
2. **Image Size:** 4:3, 16:9, 3:2 (unavailable in RAW Burst).
3. **Image Format:** RAW, JPEG, RAW+JPEG (unavailable in RAW Burst).
4. **Color:** Choose from Normal and D-Cinelike.
5. **Style:** Includes four photo styles, Standard, Landscape, Soft, and Custom.
6. **White Balance:** Refer to “White Balance” for more detailed information.

EI Mode



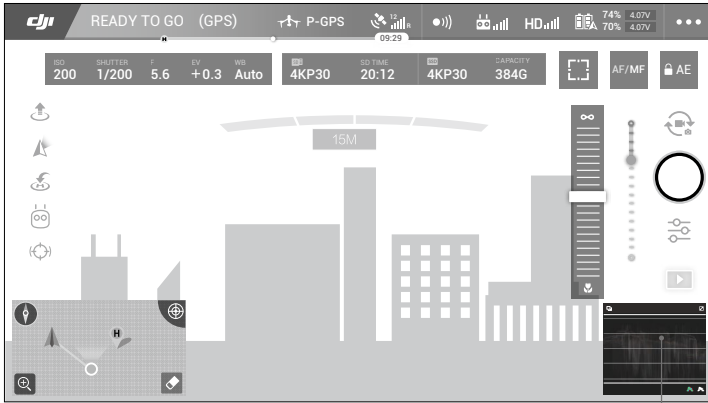

When CINESSD is enabled, the EI mode is available for use. EI mode is designed to save more data information when shooting. Therefore, the original video material will have the similar effect of a digital negative, which is perfect for post-production when creating high-end movie like videos. The default value of EI mode is 400.

Color Waveform

When recording, tap  >  > Enable Color Waveform. The color waveform will then be displayed in the bottom right corner (the same place as FPV) .





Color Waveform



Tap  to zoom in on the waveform in the middle of the screen to check the color balance. Tap  to switch between RGB and black-and-white waveforms. Tap  to disable the color waveform and go back to FPV. To enable the color waveform again, tap  >  > Enable Color Waveform.

Advanced Settings



Exposure Mode

Tap  >  to choose from the different exposure modes, including: Auto, Aperture Priority (A), Shutter Priority (S), Manual Exposure (M). By setting different EV values, a variety of exposure can be achieved in AUTO, S, and A mode. ISO values can be set in all modes. When the aircraft is in P/S/A mode, you can choose to set the ISO automatically or manually.



1. Auto

Tap  >  > AUTO. The shutter speed and aperture are set automatically to obtain the correct exposure.



2. Aperture Priority (A)

Tap  >  > A. Set your required aperture, while the camera chooses the shutter speed automatically. This mode provides a wider depth of field and can be used to blur out backgrounds.

3. S (Shutter Priority)

Tap  >  > S. Set your desired shutter speed, while the camera chooses the aperture automatically. This mode is ideal for freezing action, creating motion blur, or low-light shots.

4. M (Manual Exposure)

Tap  >  > M. Set aperture, shutter speed, and ISO based on actual needs.

Video/Photo Styles

Selecting different styles to capture photos with different sharpness levels, contrast levels, and saturation.

Tap  > Video / Photo Settings -> Style.

Or directly tap  4KP30 20:12  4KP30 384G > Style

1. Standard: A general-purpose style for most scenes.
2. Landscape: The camera will focus on as much of the scene as possible using a large depth of field.
3. Soft: Suitable for scenes with natural or soft colors.
4. Custom: Sharpness, contrast, and saturation can be set separately.

Sharpness: The photos will be softer with lower values and clearer with higher values.

Contrast: Increasing the value will make images more dramatic.

Saturation: Colors will lighten at lower values and darken at higher values.

White Balance

White balance (WB) is the process of removing unrealistic color casts. Correcting white balance can help avoid the color casts, thereby improving photos under a wider range of lighting conditions. White balance can be either set into a fixed value or a dynamic value automatically.

Tap  Video / Photo Settings > White Balance

Or directly tap  4KP30 20:12  4KP30 384G > White Balance

1. Auto (AWB)

The camera adjusts the white balance automatically.

2. Sunny / Cloudy / Incandescent / Neon

Choose one of these modes if natural-looking colors cannot be achieved through the photo styles.



3. Custom

Set a value to compensate for a specific light source.

Camera Maintenance

Cleaning the Sensor Unit

If you see dark or colored spots or lines in your images, then you may need to clean the sensor unit. The Zenmuse X7 features an ultrasonic dust-removing function. You can use the DJI GO 4 app to help remove dust from the sensor unit. **DO NOT touch the sensor with your finger under any circumstances.** Please follow these instructions to clean the dust:

1. Attach the Zenmuse X7 (lens included) to the aircraft.
2. Power on the remote controller and the aircraft, and then launch the DJI GO 4 app. After entering the camera page, tap  >  > Lens Dedusting.
3. A window will appear in the DJI GO 4 app. Tap Start to start. Follow the instructions to detach the lens. After the system detects that the lens has been successfully removed, tap Start to continue. The gimbal will start vibrating to remove the dust.
4. After the dust removal process has been completed, please attach the lens back and tap Exit.
5. Finally, check if the sensor unit has been properly cleaned either by visual inspection or by making a test capture. If further cleaning is needed, repeat the cleaning procedure.
6. If there are still dark or colored spots or lines after carrying out the Lens Dedusting procedure several times, please contact DJI or an authorized DJI dealer.



- Attach the lens to the Zenmuse X7 after lens dedusting to avoid the performance of the sensor unit being negatively affected due to air exposure.
- If you do not need to use the Zenmuse X7 after lens dedusting, please attach the camera body cap to the body and power off the aircraft to prolong product service life.



- An air blower can also be used to clean the sensor unit. Be extremely careful when using an air blower. Please contact DJI or a DJI authorized dealer whenever you encounter a problem when cleaning the sensor unit.
-

Update Firmware

The firmware of the Zenmuse X7 should be updated together with the Inspire 2. Please make sure the lens is attached to the Zenmuse X7 before updating.

Method 1: Using DJI ASSISTANT™ 2

1. Power on the Intelligent Flight Battery, and toggle the USB Mode Switch down.
2. Connect the Inspire 2 and the PC via the USB cable (with Double A ports).
3. Launch DJI Assistant 2 and login with a DJI account.
4. Click Inspire 2 and the firmware update button.
5. Select the firmware version required.
6. DJI Assistant 2 will download and upgrade the firmware automatically.
7. Restart the aircraft after the firmware upgrade is complete.

Method 2: Using the DJI GO 4 app

1. Power on the Intelligent Flight Battery, and toggle the USB Mode Switch up.
2. Connect the aircraft and your mobile device via an appropriate USB cable.
3. Follow the on-screen instructions in the DJI GO 4 app to upgrade. Ensure to connect to the Internet when downloading the firmware.
4. Restart the aircraft after the firmware update is complete.

- ⚠ • During an update, the aircraft will make a quick single beep continuously. The warning sound will then alternate between a longer beep and a quick double beep once the update is complete. Restart the aircraft after the firmware update is complete.
- If the warning sound turns into a long beep, retry the update.
- The battery level should be above 30% for the firmware update process.
- When using the DJI GO 4 app to update, you may disconnect the aircraft and the mobile device once the update is more than 30% completed. No Internet connection is required.

Specifications

General	
Product Name	Zenmuse X7
Dimensions	151 × 108 × 132 mm
Weight (Lens Excluded)	449 g
Gimbal	
Angular Vibration Range	±0.005°
Mount	Detachable
Controllable Range	Tilt: +40° to -125°; Pan: ±300°; Roll: ±20°
Mechanical Range	Tilt: +50° to -130°; Pan: ±330°; Roll: +90° to -50°
Max Controllable Speed	Tilt: 180°/s; Roll: 180°/s; Pan: 360°/s
Camera	
Sensor	Sensor size (Still): 23.5×15.7mm Sensor size (Max video recording area): 23.5×12.5mm Effective Pixels: 24MP
Supported Lenses	DJI DL-S 16mm F2.8 ND ASPH DJI DL 24mm F2.8 LS ASPH DJI DL 35mm F2.8 LS ASPH DJI DL 50mm F2.8 LS ASPH
Supported MicroSD/SSD cards	MicroSD: Class 10 or UHS-1 rating with a writing speed of 15MB/s required; Max capacity: 64 GB (some 128 GB MicroSD cards) SSD: DJI CINESSD
Recommended MicroSD Card	Sandisk Extreme 32GB UHS-3 MICROSDHC Sandisk Extreme 64GB UHS-3 MICROSDXC Panasonic 32GB UHS-3 MicroSDHC Panasonic 64GB UHS-3 MicroSDXC Samsung PRO 32GB UHS-3 MicroSDHC Samsung PRO 64GB UHS-3 MicroSDXC Samsung PRO 128GB UHS-3 MicroSDXC
Photo Size	3:2 4:3 16:9

Photo Formats	DJI CINESSD: DNG MicroSD: DNG, JPEG, DNG+JPEG
Operation Modes	Capture, Record, Playback
Still Photography Modes	MicroSD: Single Shot, Burst Shooting (3/5/7/10 shots), Auto Exposure Bracketing (3/5 bracketed shots at ± 0.7 EV bias), Interval SSD: RAW Burst (3/5/7/10/14/ ∞ frames), up to 20fps when using RAW burst, but the exact photo numbers is restricted by storage card capacity and battery power level
Shutter Speed	Electronic Shutter Speed: 1/8000 – 8s Mechanical Shutter Speed: 1/1000 – 8s (DJI DL-S 16mm F2.8 ND ASPH not supported)
ISO Range	Photo: 100 – 25600 Video: 100 – 1600 (EI mode on); 100 – 6400 (EI mode off)
Camera Features	
Exposure Mode	Auto, Manual, Shutter Priority, Aperture Priority
Exposure Compensation	± 3.0 (3 stops of light)
Metering	Center-Weighted Metering, Spot Metering (12 \times 8 area selection)
AE Lock	Supported
White Balance	Auto, Sunny, Cloudy, Incandescent, Neon, Custom (2000 K – 10000 K)
Video Caption	Supported (AVC/HEVC)
PAL/NTSC	Supported
Ultrasonic Dust Removal	Supported
Center Points	None, Circle, Cross, Narrow Cross, Square (No Center Point), Square (w. Center Point), Square (w. Center Point), Bracket (No Center Point), Bracket (w. Center Point)
Grid	None, Grid Lines, Grid+Diagonals
Aspect Ratio Overlay	None, 2.39:1, 2.35:1, 1.85:1, customize
Focus Peaking Threshold	None, Low, Normal, High
ND Filter (16mm lens only)	Auto, Enable, Disable
Smart Arm LEDs	Off, Front LEDs Auto Turn Off, Turn Off Back LEDs, Turn Off Arm LEDs
Other	Histogram, Enable Color Waveform, Over Exposure Warning, Mechanical Shutter, Video Caption, AF Focus Assistant, MF Focus Assistance, Lens Profile, Calibration ¹ , Format SD Card, Format SSD Card, Reset Camera Settings.

¹ Manual lens calibration is required when used for the first time. Incorrect calibration will result in an inability to focus to infinity. Calibrate the camera in the camera settings page in the DJI GO 4 app.

Video

Video Codec

CINESSD: CinemaDNG, Apple ProRes 422 HQ, Apple ProRes 4444 XQ

MicroSD: H.264, H.265

Storage	FPS	Frame Ratio	Format	Resolution	Bitrate (Max) ²	Effective sensor size for imaging ³
CINESSD	23.976/ 24/29.97/ 30fps	17:9	CinemaDNG	6016×3200	4.44 Gbps/s	23.5×12.5 mm
			Apple ProRes 422 HQ	4096×2160	1.99 Gbps/s	
		16:9	CinemaDNG	5760×3240	4.29 Gbps/s	
			Apple ProRes 422 HQ	3840×2160	906.9 Mbps/s	
			Apple ProRes 4444 XQ		2.08 Gbps/s	
		2.44:1	Apple ProRes 422 HQ	5280×2160	1.27 Gbps/s	23.5×9.6 mm
	47.95/ 59.94fps	17:9	CinemaDNG	3944×2088	3.66 Gbps/s	15.4×8.2 mm
			Apple ProRes 422 HQ	2048×1080	512.9 Mbps/s	
			Apple ProRes 4444 XQ		1.15 Gbps/s	
		16:9	CinemaDNG	3712×2088	3.86 Gbps/s	14.5×8.2 mm
			Apple ProRes 422 HQ	2704×1520	847.2 Mbps/s	
			Apple ProRes 4444 XQ	1920×1080	448.7 Mbps/s	
MicroSD	23.976/ 24/29.97/ 30fps	17:9	H.264	4096×2160	/	23.5×12.5 mm
			H.265		102.2 Mbps/s	
		16:9	H.264	3840×2160	/	22.5×12.7 mm
				2720×1530	/	
			H.265	1920×1080	/	
				3840×2160	97.4 Mbps/s	
	2.44:1	H.264	3840×1572	100.6 Mbps/s	23.5×9.6 mm	
		H.265		98.3 Mbps/s		
	47.95/ 59.94fps	17:9	H.264	4096×2160	100.8 Mbps/s	15.4×8.2 mm
			16:9	H.264	3840×2160	100.6 Mbps/s
		2720×1530			80.4 Mbps/s	
		H.265		1920×1080		77.5 Mbps/s
2720×1530				65.1 Mbps/s		

² This table only offers the bitrate of the max FPS in each resolution of different video codecs.³ For more details on FOV for different lenses, please go to P.11 [Lens Specifications](#).

DJI Support

<http://www.dji.com/cn/support>

This content is subject to change.

Download the latest version from

<http://www.dji.com/zenmuse-x7>

ZENMUSE is a trademark of DJI Shenzhen RYZE Tech Co., Ltd.

DJI is a trademark of DJI.

Copyright © 2017 DJI All Rights Reserved.