

Canon

EOS 90D

This manual is for the EOS 90D installed with firmware version 1.1.0 or later.



Advanced User Guide

Introduction

Before Starting to Shoot, Be Sure to Read the Following

To avoid shooting problems and accidents, first read the “Safety Instructions” (📖 25–📖 27) and “Handling Precautions” (📖 28–📖 30). Also, read this manual carefully to ensure that you use the camera correctly.

Refer to This Manual while Using the Camera to Further Familiarize Yourself with the Camera

While reading this manual, take a few test shots and see how they come out. You can then better understand the camera. Be sure to store this manual safely, too, so that you can refer to it again when necessary.

Testing the Camera Before Use and Liability

After shooting, play images back and check whether they have been properly recorded. If the camera or memory card is faulty and the images cannot be recorded or downloaded to a computer, Canon cannot be held liable for any loss or inconvenience caused.

Copyrights

Copyright laws in some countries prohibit the unauthorized use of images recorded with the camera (or music/images with music transferred to the memory card) for purposes other than personal enjoyment. Also be aware that certain public performances, exhibitions, etc. may prohibit photography even for private enjoyment.

Item Check List

Before starting, check that all the following items are included with your camera. If anything is missing, contact your dealer.



Camera
(with body cap)



Battery Pack LP-E6N
(with protective cover)



Battery Charger
LC-E6/LC-E6E*

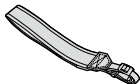

Strap

* Battery Charger LC-E6 or LC-E6E is provided. (The LC-E6E comes with a power cord.)

- The camera does not come with a memory card (📖 10), interface cable, or HDMI cable.
- For details on the Advanced User Guide and Instruction Manuals, see the next page.
- If you purchased a Lens Kit, check that the lenses are included.
- Be careful not to lose any of the above items.



- When you need Lens Instruction Manuals, download them from the Canon website (📖 4).

The Lens Instruction Manuals (PDF files) are for lenses sold individually. Note that when purchasing the Lens Kit, some of the accessories included with the lens may not match those listed in the Lens Instruction Manual.

Instruction Manuals



The Instruction Manual included with the camera provides basic instructions for the camera and Wi-Fi functions.

The Advanced User Guide (this PDF file) with complete instructions and separate Supplemental Information PDF with specifications and other details can be downloaded from the Canon website to a computer or other device.

Downloading the Advanced User Guide/Instruction Manuals

The Advanced User Guide and Instruction Manuals for lenses and software (PDF files) can be downloaded from the Canon website to a computer or other device.

● Download site

● Advanced User Guide or Supplemental Information

www.canon.com/icpd

● Lens Instruction Manual

www.canon.com/icpd

● Software Instruction Manual

www.canon.com/icpd



- To view the PDF files, an Adobe PDF viewing software such as Adobe Acrobat Reader DC (most recent version recommended) is required.
- Adobe Acrobat Reader DC can be downloaded for free from the Internet.
- Double-click the downloaded PDF file to open it.
- To learn how to use PDF viewing software, refer to the software's Help section or the like.

Downloading the Advanced User Guide/Instruction Manuals Using QR Code

The Advanced User Guide and Instruction Manuals for lenses and software (PDF files) can be downloaded to a smartphone or tablet using the QR code.

www.canon.com/icpd



- A software app is required to read the QR code.
- Select your country or region of residence, then download the Advanced User Guide/Instruction Manuals.
- Select [**📄**: **Manual/software URL**] to display the QR code on the camera screen.

Quick Start Guide

1

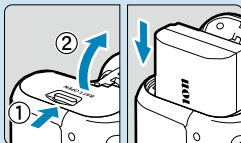

Insert the battery (47).

- Upon purchase, charge the battery to start using (44).

2

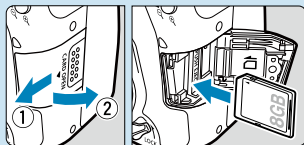

Insert the card (48).

- With the card's label facing toward the back of the camera, insert it into the card slot.

3

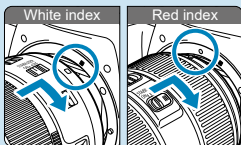

Attach the lens (54).

- Align the mount indexes on the lens and camera (red or white) to attach the lens.

4

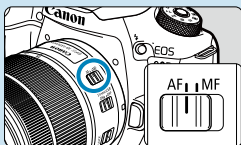

Set the lens's focus mode switch to <AF> (54).

5

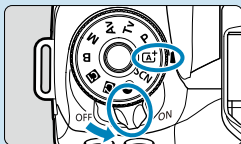

Set the power switch to <ON>, then set the Mode dial to <A+> (52).

- Turn the Mode dial while holding down the center.
- All the necessary camera settings will be set automatically.

6

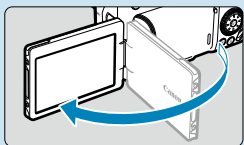
**Flip out the screen (51).**

- When the date/time/zone setting screen is displayed, see 516.

7

**Focus on the subject (57).**

- Look through the viewfinder and center the subject on the screen.
- Press the shutter button halfway, and the camera will focus on the subject.
- If <⚡> blinks in the viewfinder, press the <⚡> button to raise the built-in flash.

8

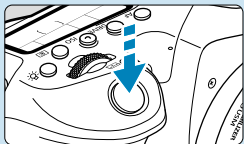
**Take the picture (57).**

- Press the shutter button completely to take the picture.

9







**Review the picture.**

- The image just captured will be displayed for approx. 2 sec. on the screen.
- To display the image again, press the <▶> button (332).



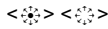



- To shoot while looking at the screen, see “Live View Shooting” (71).

About This Manual

Icons in this Manual

-  : Indicates the Main dial.
-  : Indicates the Quick control dial.
-  : Indicates Multi-controller 1 and 2.
-  : Indicates the direction to press the Multi-controller.
-  : Indicates the Setting button.
-  : Indicates the duration (in * seconds) of the operation for the button you pressed, as timed after you release the button.

• In addition to the above, the icons and symbols used on the camera's buttons and displayed on the screen are also used in this manual when discussing relevant operations and functionality.

-  : A ☆ icon to the right of a page title indicates that the function is available only in Creative Zone <P>, <Tv>, <Av>, <M>, or mode.
-  *** : Reference page numbers for more information.
-  : Warning to prevent shooting problems.
-  : Supplemental information.
-  : Tips or advice for better shooting.
-  : Troubleshooting advice.

Basic Assumptions for Operational Instructions, Sample Photos

- Before following any instructions, make sure the power switch is set to <ON> and the Multi-function lock feature is off (📖 52, 📖 60).
- It is assumed that all the menu settings and Custom Functions are set to their defaults.
- The illustrations in this manual show the camera attached with the EF-S18-135mm f/3.5-5.6 IS USM lens as an example.
- The sample photos displayed on the camera and used in this manual are for instructional purposes only.

Compatible Cards

The following cards can be used with the camera regardless of capacity. **If the card is new or was previously formatted (initialized) by another camera or computer, format the card with this camera** (📖 511).

- **SD/SDHC/SDXC memory cards**

UHS-II and UHS-I cards supported.

Cards that Can Record Movies

When recording movies, use a high-capacity card with ample performance (fast enough writing and reading speeds) for the movie recording size. For details, see 📖 618.



In this manual, “card” refers to SD memory cards, SDHC memory cards, and SDXC memory cards.

* **The camera does not come with a card for recording photos/movies.** Please purchase it separately.

Chapters

Introduction	2
<hr/>	
Preparation and Basic Operations	43
<hr/>	
Basic Zone	75
<hr/>	
Creative Zone	109
<hr/>	
AF, Drive, and Exposure Settings	123
<hr/>	
Flash Photography	163
<hr/>	
Shooting	191
<hr/>	
Playback	329
<hr/>	
Wireless Features	395
<hr/>	
Set-up	501
<hr/>	
Custom Functions / My Menu	551
<hr/>	
Reference	589
<hr/>	

Contents

Introduction	2
Item Check List	3
Instruction Manuals	4
Quick Start Guide	6
About This Manual	8
Compatible Cards	10
Chapters.....	11
Contents.....	12
Index to Features	21
Safety Instructions	25
Handling Precautions	28
Part Names	31
Preparation and Basic Operations	43
Charging the Battery	44
Inserting/Removing the Battery.....	47
Inserting and Removing the Card	48
Using the Screen	51
Turning on the Power.....	52
Attaching and Detaching a Lens	54
Basic Operations.....	56
Menu Operations and Settings	63
Quick Control	67
Touch-Screen Operation	70
Viewing the Screen as You Shoot (Live View Shooting).....	71

Basic Zone 75

Fully Automatic Shooting (Scene Intelligent Auto)	76
Special Scene Mode	84
Shooting Portraits	86
Shooting Group Photos.....	87
Shooting Landscapes	88
Shooting Moving Subjects	89
Photographing Children	90
Panning.....	91
Shooting Close-ups.....	93
Shooting Food.....	94
Shooting Candlelight Portraits	95
Shooting Night Portraits (With a Tripod)	96
Handheld Shooting of Night Scenes	97
Shooting Backlit Scenes	98
Cautions for the <SCN> Modes	99
Shooting with Filter Effects Applied.....	103

Creative Zone 109

Program AE.....	110
Setting the Shutter Speed Before Shooting (Shutter-Priority AE)	112
Setting the Aperture Value Before Shooting (Aperture-Priority AE) ...	114
Setting the Exposure Before Shooting (Manual Exposure)	117
Long (Bulb) Exposures	119

AF, Drive, and Exposure Settings	123
Selecting the AF Operation	124
Selecting the AF Area and AF Point (Viewfinder Shooting).....	128
Selecting the AF Method (Live View Shooting).....	135
Manual Focus.....	147
Selecting the Drive Mode	150
Using the Self-Timer	153
Remote Control Shooting.....	155
Eyepiece Cover.....	157
Selecting the Metering Mode	158
Exposure Compensation.....	160
Locking the Exposure (AE Lock).....	161
Flash Photography	163
Shooting With the Built-in Flash.....	164
Flash Function Settings	168
Shooting With External Speedlites.....	179
Wireless Flash Photography Using Optical Transmission.....	180
Shooting	191
Still Photo Shooting	192
Tab Menu: Still Photo Shooting (Viewfinder Shooting).....	193
Tab Menu: Still Photo Shooting (Live View Shooting)	196
Image Quality Settings	199
Still Image Aspect Ratio	202

Image Review Time.....	204
Card Reminder.....	205
Correction of Lens Aberrations due to Optical Characteristics	206
Auto Exposure Bracketing (AEB).....	211
ISO Speed Settings for Still Photos	213
Auto Correction of Brightness and Contrast (Auto Lighting Optimizer)	218
Highlight Tone Priority Settings	219
Metering Timer (Live View Shooting)	220
Exposure Simulation (Live View Shooting)	221
White Balance Settings	222
White Balance Correction	227
Color Space Settings	229
Picture Style Selection	230
Picture Style Customization	233
Picture Style Registration.....	236
Noise Reduction Settings.....	238
Appending Dust Delete Data	241
Shutter Release Method (Live View Shooting)	243
Multiple Exposures.....	245
HDR (High Dynamic Range) Shooting.....	251
Focus Bracketing (Live View Shooting)	255
Interval Timer Shooting	258
Flicker Effect Reduction	261
Mirror Lockup	263

Continuous AF (Live View Shooting).....	265
Lens Electronic MF Settings	266
AF-Assist Beam Settings	267
General Still Photo Shooting Cautions.....	269

Movie Recording 273

Tab Menus: Movie Recording	274
Movie Recording	277
HDR Movie Recording	284
Movie Recording With Filter Effects Applied	285
Movie Recording Quality Settings.....	288
Setting the Sound Recording	295
Movie Digital IS	298
Recording Time-lapse Movies.....	300
Recording Video Snapshots.....	312
Movie Servo AF.....	317
Movie Servo AF Track Sensitivity.....	319
Movie Servo AF Speed	320
Other Menu Functions	322
General Movie Recording Cautions	326

Playback 329

Tab Menus: Playback.....	330
Image Playback	332
Index Display (Multiple-Image Display).....	334
Magnified Image Display.....	336
Movie Playback.....	337

Editing a Movie's First and Last Scenes	340
Frame Extraction from 4K Movies or 4K Time-Lapse Movies	342
Playback on a TV Set.....	344
Protecting images	346
Image Rotation.....	349
Erasing Images	350
Digital Print Order Format (DPOF).....	354
Specifying Images for a Photobook	358
Creative Filter Effects.....	361
RAW Image Processing	364
Processing With Your Preferred Effects Applied (Creative Assist)	370
Selecting the Type of RAW Image Processing	372
Red-Eye Correction.....	373
Editing Video Snapshot Albums	374
Cropping JPEG Images	377
Resizing JPEG Images	379
Image Ratings.....	380
Image Slide Shows (Auto Playback).....	383
Filtering Images for Playback.....	385
Jump Display (Jumping Through Images)	387
Customizing Playback Information Display	389
Displaying the Highlight Alert	391
AF Point Display.....	392
Grid Display.....	393
Specifying Initial Image Display When Playback Begins	394

Wireless Features 395

Tab Menus: Wireless Tab	396
Selection of Wi-Fi/Bluetooth Connection	397
Connecting to a Smartphone	399
Connecting to a Computer via Wi-Fi	426
Connecting to a Printer via Wi-Fi	434
Sending Images to a Web Service	444
Wi-Fi Connection via Access Points	458
Connecting to a Wireless Remote Control	464
Reconnecting via Wi-Fi	467
Registering Multiple Connection Settings	469
Wi-Fi Settings	470
Bluetooth Settings	471
Changing the Nickname	472
Geotagging Images with GPS Information from Other Devices	473
Changing or Deleting Connection Settings	478
Clearing Wireless Communication Settings to Default	480
View Info Screen	481
Virtual Keyboard Operations	482
Responding to Error Messages	483
Wireless Communication Function Notes	494
Security	496
Checking Network Settings	497
Wireless Communication Status	498

Set-up	501
Tab Menus: Set-up	502
Creating and Selecting a Folder	505
File Numbering Methods	507
The Auto Rotation of Vertical Images	510
Formatting Memory Cards	511
Auto Power Off	513
Adjusting the Screen Brightness	514
Turning the Screen Off/On	515
Setting the Date, Time, and Time Zone	516
Interface Language	519
Video System	520
Touch Sensitivity Settings	521
Beeping for Camera Operations	522
Headphone Volume	523
Checking the Battery Information	524
Sensor Cleaning	528
Displaying the Shooting Mode Guide	532
Feature Guide Display	533
Help Features	534
Customization of Information in the Viewfinder	536
<INFO> Button Display Options	538
Customization of On-Screen Information	539
Shutter Button Customization for Movie Recording	542
HDMI Output Resolution	543
RAW Image Display on HDR TVs	544

Multi-Function Lock	545
Registering Custom Shooting Modes	546
Restoring Camera Defaults	547
Copyright Information	548
Other Information	550

Custom Functions / My Menu 551

Tab Menus: Customization	552
Setting Custom Functions	553
Custom Functions	554
Custom Function Setting Items	556
Fine Adjustment of AF Position (AF Microadjustment)	575
Clearing Custom Function Settings	581
Tab Menus: My Menu	582
Registering My Menu	583

Reference 589

Software	590
Importing Images to a Computer	592
Battery Grip BG-E14	594
Household Power Outlet Accessory	594
Troubleshooting Guide	595
Error Codes	613
Performance Data	614
Information Display	622
Index	635

Index to Features

Power

- Charging the battery (📖 44)
- Battery level (📖 53)
- Power saving (📖 513)
- Checking battery information (📖 524)

Cards

- Releasing shutter without card (📖 205)
- Formatting (📖 511)
- Cards compatible with movie recording (📖 617)

Lens

- Attaching (📖 54)
- Detaching (📖 55)

Basic Settings

- Date/Time/Zone (📖 516)
- Language (📖 519)
- Beeper (📖 522)
- Clear all camera settings (📖 547)
- Copyright information (📖 548)

Viewfinder

- Dioptic adjustment (📖 56)
- Information display in viewfinder (📖 536)
- Viewfinder display format (📖 536)

Screen

- Vari-angle (📖 51)
- Touch control (📖 70)
- Brightness (📖 514)
- Help (📖 534)
- Electronic level (📖 539)

AF

- AF operation (📖 124)
- AF method (📖 135)
- AF point selection (📖 140)
- Eye Detection AF (📖 142)
- Manual focusing (📖 147)
- MF peaking settings (📖 149)
- Continuous AF (📖 265)
- Electronic manual focus (📖 266)
- AF-assist beam (📖 267)

Metering

- Metering mode (📖 158)

Drive

- Drive mode (📖 150)
- Self-timer (📖 153)
- Maximum burst (📖 201)

Image Recording Settings

- Creating/Selecting a folder (📖 505)
- File numbering (📖 507)

Image Quality

- Image quality (📖 199)
- Still image aspect ratio (📖 202)
- Lens aberration correction (📖 206)
- ISO speed (still photos) (📖 213)
- Auto Lighting Optimizer (📖 218)
- Highlight tone priority (📖 219)
- White balance (📖 222)
- Picture Style (📖 230)
- Noise reduction for long exposures (📖 238)
- Noise reduction for high ISO speeds (📖 239)
- Reducing flicker (📖 261)

Shooting

- Shooting mode (📖 38)
- Multi-function lock (📖 60)
- Quick Control (📖 67)
- Touch shutter (📖 72)
- Creative Assist (📖 82)
- Creative filters (📖 103)
- Depth-of-field preview (📖 116)
- Bulb timer (📖 120)
- Magnified view (📖 144)
- Remote control (📖 155)
- Remote switch (📖 156)

- Multiple exposures (📖 245)
- HDR mode (📖 251)
- Focus bracketing (📖 255)
- Interval timer (📖 258)
- Mirror lockup (📖 263)
- Shooting information display (📖 539)
- Grid display (📖 540)
- Error codes (📖 613)

Exposure

- Exposure compensation with M+ISO Auto (📖 118)
- Exposure compensation (📖 160)
- AE lock (📖 161)
- AEB (📖 211)
- Exposure simulation (📖 221)
- Safety shift (📖 558)

Flash

- Built-in flash (📖 164)
- Flash exposure compensation (📖 166)
- FE lock (📖 167)
- Flash function settings (📖 168)
- External flash (📖 179)
- Optical wireless flash photography (📖 180)

Movie Recording

- Autoexposure recording (📖 277)
- Manual exposure recording (📖 279)
- HDR movie (📖 284)
- Creative filters mode (📖 285)
- Movie recording size (📖 288)
- Wind filter (📖 295)
- Sound recording (📖 295)
- Microphone (📖 296)
- Attenuator (📖 296)
- Time-lapse movie (📖 300)
- Video snapshot (📖 312)
- Movie Servo AF (📖 317)
- Movie Servo AF track sensitivity (📖 319)
- Movie Servo AF speed (📖 320)
- ISO speed (movie) (📖 322)
- Remote control shooting (📖 322)
- Auto slow shutter (📖 324)
- HDMI output (📖 325)
- 4K movie (📖 342)
- Headphone (📖 523)
- HDMI output resolution (📖 543)

Playback

- Image review time (📖 204)
- Single-image display (📖 332)
- Touch playback (📖 335)
- Magnified view (📖 336)
- Index display (📖 334)
- Movie playback (📖 337)
- Editing a movie's first and last scenes (📖 340)
- Frame Grab (4K) (📖 342)
- Viewing images on a television (📖 344)
- Protect (📖 346)
- Image rotation (📖 349)
- Erasing (📖 350)
- Rating (📖 380)
- Slide show (📖 383)
- Setting image search conditions (📖 385)
- Image browsing (Jump display) (📖 387)
- Playback information display (📖 389)
- Highlight alert (📖 391)
- AF point display (📖 392)
- Grid display (📖 393)
- Shooting information display (📖 539)
- HDR output (📖 544)

Image Editing

- Creative filters (📖 361)
- RAW image processing (📖 364)
- Red-eye correction (📖 373)
- Video snapshot album (📖 374)
- Cropping JPEGs (📖 377)
- Resizing JPEGs (📖 379)

Print Order

- Print order (DPOF) (📖 354)
- Photobook Set-up (📖 358)

Customization

- Custom shooting mode (📖 546)
- Custom Functions (C.Fn) (📖 552)
- Custom Controls (📖 571)
- My Menu (📖 583)

Sensor Cleaning and Dust Reduction

- Appending Dust Delete Data (📖 241)
- Sensor cleaning (📖 528)
- Manual sensor cleaning (📖 530)

Software

- Downloading and Installing (📖 590)
- Software Instruction Manuals (📖 591)

Wireless Features

- Connect to smartphones (📖 399)
- Auto send images to smartphones (📖 412)
- Remote control (EOS Utility) (📖 426)
- Auto send images to computers (📖 431)
- Print from Wi-Fi printers (📖 434)
- Upload to Web services (📖 444)
- Connect to a wireless remote control (📖 464)
- Geotagging Images (📖 473)
- Clear wireless settings (📖 480)

Safety Instructions

Be sure to read these instructions in order to operate the product safely. Follow these instructions to prevent injury or harm to the operator of the product or others.



WARNING: Denotes the risk of serious injury or death.

- Keep the product out of the reach of young children.

A strap wrapped around a person's neck may result in strangulation.

The parts or provided items of cameras or accessories are dangerous if swallowed. If swallowed, seek immediate medical assistance.

The battery is dangerous if swallowed. If swallowed, seek immediate medical assistance.

- Use only power sources specified in this instruction manual for use with the product.
- Do not disassemble or modify the product.
- Do not expose the product to strong shocks or vibration.
- Do not touch any exposed internal parts.
- Stop using the product in any case of unusual circumstances such as the presence of smoke or a strange smell.
- Do not use organic solvents such as alcohol, benzene or paint thinner to clean the product.
- Do not get the product wet. Do not insert foreign objects or liquids into the product.
- Do not use the product where flammable gases may be present.

This may cause electric shock, explosion or fire.

- Do not leave a lens or a camera/camcorder with a lens attached, exposed without the lens cap attached.

The lens may concentrate the light and cause fire.

- For products featuring a viewfinder, do not look through the viewfinder at strong light sources such as the sun on a bright day or lasers and other strong artificial light sources.

This may harm your vision.

- Do not touch the product connected to a power outlet during lightning storms.

This may cause electric shock.

- Observe the following instructions when using commercially available batteries or provided battery packs.
 - Use batteries/battery packs only with their specified product.
 - Do not heat batteries/battery packs or expose them to fire.
 - Do not charge batteries/battery packs using non-authorized battery chargers.
 - Do not expose the terminals to dirt or let them come into contact with metallic pins or other metal objects.
 - Do not use leaking batteries/battery packs.
 - When disposing of batteries/battery packs, insulate the terminals with tape or other means.

This may cause electric shock, explosion or fire.

If a battery/battery pack leaks and the material contacts your skin or clothing, flush the exposed area thoroughly with running water. In case of eye contact, flush thoroughly with copious amounts of clean running water and seek immediate medical assistance.

- Observe the following instructions when using a battery charger.
 - Periodically remove any dust buildup from the power plug and power outlet using a dry cloth.
 - Do not plug in or unplug the product with wet hands.
 - Do not use the product if the power plug is not fully inserted into the power outlet.
 - Do not expose the power plug and terminals to dirt or let them come into contact with metallic pins or other metal objects.
- Do not place heavy objects on the power cord. Do not damage, break or modify the power cord.
- Do not wrap the product in cloth or other materials when in use or shortly after use when the product is still warm in temperature.
- Do not unplug the product by pulling the power cord.
- Do not leave the product connected to a power source for long periods of time.
- Do not charge batteries/battery packs at temperatures outside the range of 5 - 40 °C (41 - 104 °F).

This may cause electric shock, explosion or fire.

- Do not allow the product to maintain contact with the same area of skin for extended periods of time during use.

This may result in low-temperature contact burns, including skin redness and blistering, even if the product does not feel hot. The use of a tripod or similar equipment is recommended when using the product in hot places and for people with circulation problems or less sensitive skin.

- Follow any indications to turn off the product in places where its use is forbidden.

Not doing so may cause other equipment to malfunction due to the effect of electromagnetic waves and even result in accidents.

**CAUTION:** Denotes the risk of injury.

- Do not fire the flash near the eyes.

It may hurt the eyes.

- Do not look at the screen or through the viewfinder for prolonged periods of time. This may induce symptoms similar to motion sickness. In such a case, stop using the product immediately and rest for a while before resuming use.

- Flash emits high temperatures when fired. Keep fingers, any other part of your body, and objects away from the flash unit while taking pictures.

This may cause burns or malfunction of the flash.

- Do not leave the product in places exposed to extremely high or low temperatures.

The product may become extremely hot/cold and cause burns or injury when touched.

- Strap is intended for use on the body only. Hanging the strap with any product attached on a hook or other object may damage the product. Also, do not shake the product or expose the product to strong impacts.

- Do not apply strong pressure on the lens or allow an object to hit it.

This may cause injury or damage to the product.

- Only mount the product on a tripod that is sufficiently sturdy.

- Do not carry the product when it is mounted on a tripod.

This may cause injury or may result in an accident.

- Do not touch any parts inside the product.

This may cause injury.

- If any abnormal skin reaction or irritation occurs during or following the use of this product, refrain from further use and get medical advice/attention.

Handling Precautions

Camera Care

- This camera is a precision instrument. Do not drop it or subject it to physical shock.
- The camera is not waterproof and cannot be used underwater.
- To maximize the camera's dust- and drip- resistance, keep the terminal cover, battery compartment cover, card slot cover, and all other covers firmly closed.
- This camera is designed to be dust- and drip- resistant, in order to help prevent sand, dust, dirt, or water that falls on it unexpectedly from getting inside, but it is impossible to prevent dirt, dust, water, or salt from getting inside at all. As far as possible, do not allow dirt, dust, water, or salt to get on the camera.
- If water gets on the camera, wipe it off with a dry and clean cloth. If dirt, dust, or salt gets on the camera, wipe it off with a clean, well-wrung wet cloth.
- Using the camera in a location with large amounts of dirt or dust may cause a malfunction.
- Cleaning the camera after use is recommended. Allowing dirt, dust, water, or salt to remain on the camera may cause a malfunction.
- If you accidentally drop the camera into water or are concerned that moisture (water), dirt, dust, or salt may have gotten inside it, promptly consult the nearest Canon Service Center.
- Never leave the camera near anything having a strong magnetic field such as a magnet or electric motor. Also, avoid using or leaving the camera near anything emitting strong radio waves, such as a large antenna. Strong magnetic fields can cause camera malfunction or destroy image data.
- Do not leave the camera in excessive heat, such as in a car in direct sunlight. High temperatures can cause the camera to malfunction.
- The camera contains precision electronic circuitry. Never attempt to disassemble the camera yourself.

- Do not block the mirror operation with your finger, etc. Doing so may cause a malfunction.
- Use only a commercially available blower to blow away dust when it adheres to the lens, viewfinder, mirror, focusing screen etc. Do not use cleaners that contain organic solvents to clean the camera body or lens. For stubborn dirt, take the camera to the nearest Canon Service Center.
- Do not touch the camera's electrical contacts with your fingers. This is to prevent the contacts from corroding. Corroded contacts can cause camera malfunction.
- If the camera is suddenly brought in from the cold into a warm room, condensation may form on the camera and internal parts. To prevent condensation, first put the camera in a sealed plastic bag and let it adjust to the warmer temperature before taking it out of the bag.
- If condensation forms on the camera, to avoid damage, do not use the camera or remove the lens, card, or battery. Turn the camera off and wait until the moisture has fully evaporated before resuming use. Even after the camera is completely dry, if it is still internally cold, do not remove the lens, card, or battery until the camera has adjusted to the ambient temperature.
- If the camera will not be used for an extended period, remove the battery and store the camera in a cool, dry, well-ventilated location. Even while the camera is in storage, press the shutter button a few times once in a while to check that the camera is still working.
- Avoid storing the camera where there are chemicals that result in rust and corrosion such as in a chemical lab.
- If the camera has not been used for an extended period, test all its functions before using it. If you have not used the camera for some time or if there is an important shoot such as a foreign trip coming up, have the camera checked by your nearest Canon Service Center or check the camera yourself and make sure it is working properly.
- If you repeat continuous shooting or perform Live View shooting or movie shooting for a prolonged period, the camera may become hot. This is not a malfunction.
- If there is a bright light source inside or outside the image area, ghosting may occur.

Screen and LCD Panel

- Although the screen is manufactured with very high precision technology with over 99.99% effective pixels, 0.01% or fewer of the pixels may be dead, and there may also be spots of black, red, or other colors. This is not a malfunction. They do not affect the images recorded.
- If the screen is left on for a prolonged period, screen burn-in may occur where you see remnants of what was displayed. However, this is only temporary and will disappear when the camera is left unused for a few days.
- The screen display may seem slightly slow in low temperatures or may look black in high temperatures. It will return to normal at room temperature.

Cards

To protect the card and its recorded data, note the following:

- Do not drop, bend, or wet the card. Do not subject it to excessive force, physical shock, or vibration.
- Do not touch the card's electronic contacts with your fingers or anything metallic.
- Do not affix any stickers, etc. on the card.
- Do not store or use the card near anything that has a strong magnetic field, such as a television, speakers, or magnets. Also avoid places prone to having static electricity.
- Do not leave the card in direct sunlight or near a heat source.
- Store the card in a case.
- Do not store the card in hot, dusty, or humid locations.

Lens

- After detaching the lens from the camera, put down the lens with the rear end up and attach the rear lens cap to avoid scratching the lens surface and electrical contacts (1).



Part Names

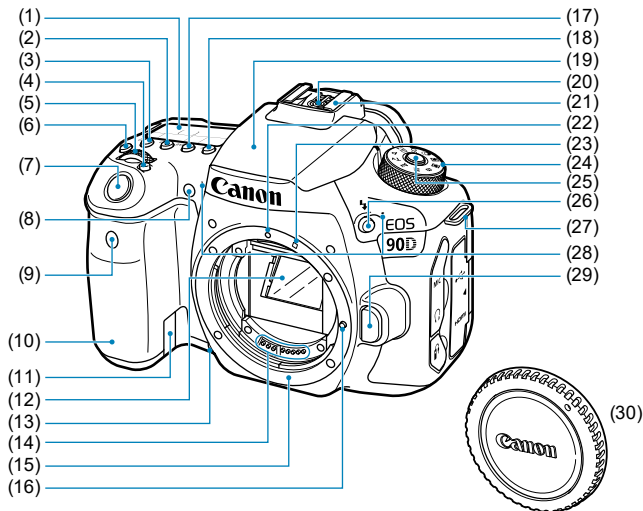

(1) LCD panel	(16) Lens lock pin
(2) <ISO> ISO speed setting button	(17) <DRIVE> Drive mode selection button
(3) <☉> Metering mode selection button	(18) <AF> AF operation/AF method selection button
(4) <☐> AF area/AF method selection button	(19) Built-in flash/AF-assist beam emitter
(5) <MAIN DIAL> Main dial	(20) Flash sync contacts
(6) <☀> LCD panel illumination button	(21) Hot shoe
(7) Shutter button	(22) EF lens mount index
(8) Red-eye reduction/Self-timer/Remote control lamp	(23) EF-S lens mount index
(9) Remote control sensor	(24) Mode dial
(10) Grip (Battery compartment)	(25) Mode dial lock-release button
(11) DC coupler cord hole	(26) <⚡> Flash button
(12) Mirror	(27) Strap mount
(13) Depth-of-field preview button	(28) Built-in microphones
(14) Contacts	(29) Lens release button
(15) Lens mount	(30) Body cap

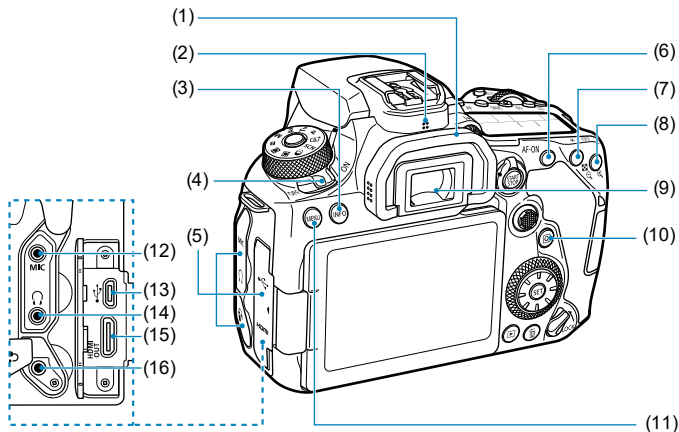

- (1) Eyecup
- (2) Speaker
- (3) <INFO> Info button
- (4) Power switch
- (5) Terminal cover

- (9) Viewfinder eyepiece
- (10) <Q> Quick Control button
- (11) <MENU> Menu button
- (12) <MIC> External microphone IN terminal
- (13) <Digital> Digital terminal
- (14) <Headphone> Headphone terminal
- (15) <HDMI OUT> HDMI mini OUT terminal
- (16) <Remote control> Remote control terminal

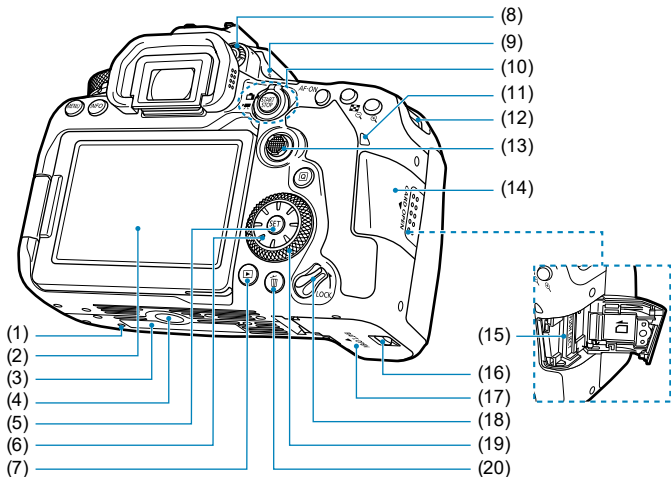

(1) Accessory positioning hole

(2) Screen

(3) Serial number

(4) Tripod socket

(5) <SET> Setting button

(6) <⊙> <▲> <▼> <◀> <▶>
Multi-controller 2

(7) <▶> Playback button

(8) Dioptic adjustment knob

(9) <⊕> Focal plane mark

(10) <📹> Live View shooting/
<🎥> Movie shooting switch

<START
STOP> Start/Stop button

(11) Access lamp

(12) Strap mount

(13) <⊙> Multi-controller 1

(14) Card slot cover

(15) Card slot

(16) Battery compartment cover lock

(17) Battery compartment cover

(18) Multi-function lock switch

(19) <⊙> Quick control dial

(20) <🗑️> Erase button

Viewfinder Information Display

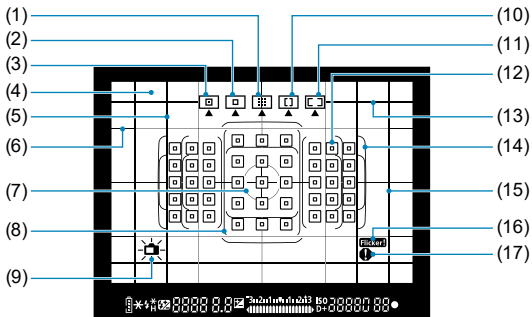

(1) Zone AF (Manual selection of zone)

(2) 1-point AF (Manual selection)

(3) Spot AF (Manual selection)

(4) Focusing screen

(5) Aspect ratio line (1:1)

(6) Grid

(7) Spot metering circle

(8) Large Zone AF frame

(9) Electronic level

(10) Large Zone AF (Manual selection of zone)

(11) Automatic selection AF

(12) <□> 1-point AF point
<□> Spot AF point

(13) Aspect ratio line (16:9)

(14) Area AF frame

(15) Aspect ratio line (4:3)

(16) < Flicker! > Flicker detection

(17) < ! > Warning icon

* The display will show only the settings currently applied.

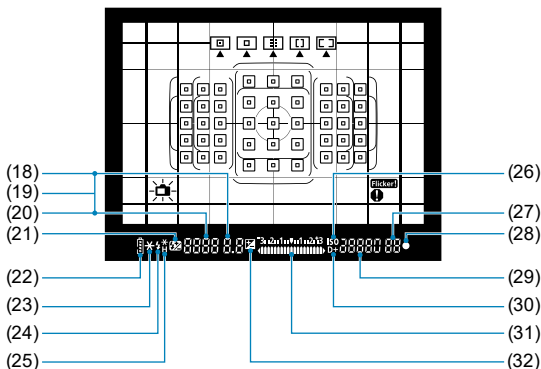

- | | |
|--|--|
| (18) Aperture value | (25) <⚡*> FE lock |
| (19) AF point selection
([] AF, SEL [], SEL AF) | FEB in-progress |
| (20) Shutter speed | <⚡H> High-speed sync |
| Bulb (buLb) | (26) <ISO> ISO speed |
| FE lock (FEL) | (27) Maximum burst |
| Busy/Charging the flash (buSY) | Number of remaining multiple exposures |
| Multi-function lock warning (L) | (28) <●> Focus indicator |
| No card warning (Card) | (29) ISO speed |
| Card full warning (FuLL) | (30) <D+> Highlight tone priority |
| Card error warning (Card) | (31) Exposure level indicator |
| Error codes (Err) | Exposure compensation amount |
| (21) <⚡> Flash exposure compensation | AEB range |
| (22) <🔋> Battery level | Red-eye reduction lamp on indicator |
| (23) <⚡> AE lock | (32) <⚡> Exposure compensation |
| AEB in-progress | |
| (24) <⚡> Warning to use flash (blinking) | |
| Flash ready (on) | |
| FE lock out of range warning (blinking) | |

* The display will show only the settings currently applied.



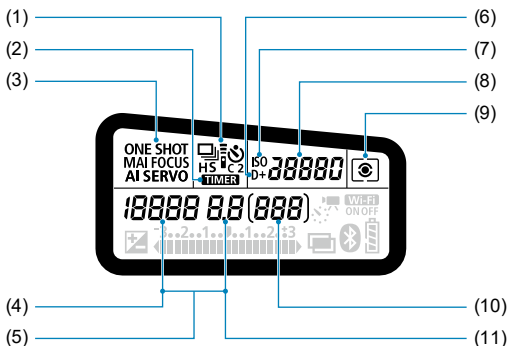

LCD Panel

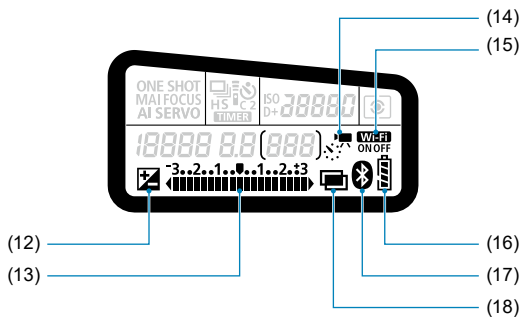

- | | |
|--|---|
| (1) Drive mode | (5) AF point selection
([] AF, SEL [], SEL AF) |
| (2) <TIMER> Bulb timer/Interval timer | (6) <D+> Highlight tone priority |
| (3) AF operation | (7) <ISO> ISO speed |
| (4) Shutter speed
Bulb (buLb)
FE lock (FEL)
Remaining number of shots for time-lapse movie
Busy/Charging the flash (buSY)
Multi-function lock warning (L)
Cleaning image sensor (CLn)
No card warning (Card)
Card full warning (FuLL)
Card error warning (Card)
Error codes (Err) | (8) ISO speed |
| | (9) Metering mode |
| | (10) Number of possible shots
Self-timer countdown
Bulb exposure time
Error number
Remaining images to record |
| | (11) Aperture value |

* The display will show only the settings currently applied.



-
- (12)  Exposure compensation
-
- (13) Exposure level indicator
Exposure compensation amount
AEB range
Red-eye reduction lamp on indicator
-
- (14)  Time-lapse movies
-
- (15)  Wi-Fi function
-
- (16) Battery level
-
- (17)  Bluetooth function
-
- (18)  Multiple exposures
-

Mode Dial

Turn the Mode dial while holding down the lock-release button in the center.

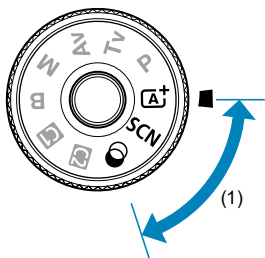

(1) Basic Zone

All you do is press the shutter button. The camera sets everything to suit the subject or scene for shooting.

A+ : Scene Intelligent Auto (📖 76)

SCN : Special scene (📖 84)

	Portrait (📖 86)		Close-up (📖 93)
	Group Photo (📖 87)		Food (📖 94)
	Landscape (📖 88)		Candlelight (📖 95)
	Sports (📖 89)		Night Portrait (📖 96)
	Kids (📖 90)		Handheld Night Scene (📖 97)
	Panning (📖 91)		HDR Backlight Control (📖 98)

: Creative filters (📖 103)

	Grainy B/W (📖 105)		Miniature effect (📖 106)
	Soft focus (📖 105)		HDR art standard (📖 106)
	Fish-eye effect (📖 105)		HDR art vivid (📖 106)
	Water painting effect (📖 105)		HDR art bold (📖 106)
	Toy camera effect (📖 105)		HDR art embossed (📖 106)

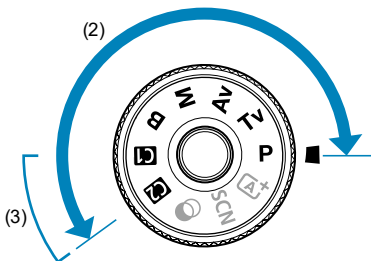

(2) Creative Zone

These modes give you more control for shooting various subjects as desired.

P	Program AE (📖 110)
Tv	Shutter-priority AE (📖 112)
Av	Aperture-priority AE (📖 114)
M	Manual exposure (📖 117)
B	Bulb (📖 119)

(3) Custom shooting modes

You can assign <P>, <Tv>, <Av>, <M>, , AF operation, menu functions, and more to <G1>, or <G2> (📖 546).

Battery Charger LC-E6

Charger for Battery Pack LP-E6N/LP-E6 (📖 44).

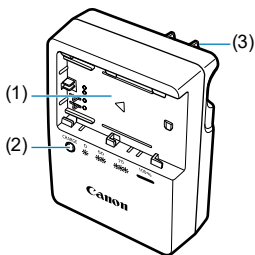

- (1) Battery pack slot
- (2) Charge lamp
- (3) Power plug

Battery Charger LC-E6E

Charger for Battery Pack LP-E6N/LP-E6 (📖 44).

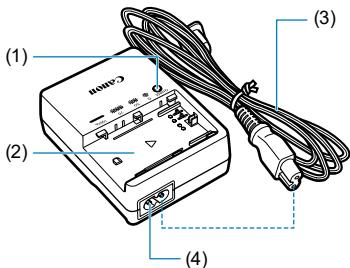

- (1) Charge lamp
- (2) Battery pack slot
- (3) Power cord
- (4) Power cord socket

Attaching the Strap

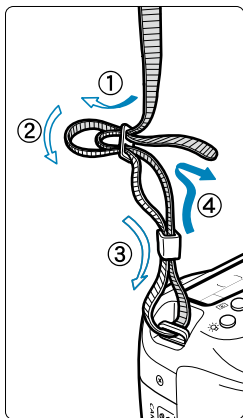

Pass the end of the strap through the camera's strap mount eyelet from the bottom. Then pass it through the strap's buckle as shown in the illustration. Pull the strap to take up any slack and make sure the strap will not loosen from the buckle.

- The eyepiece cover (1) is attached to the strap (📖 157).

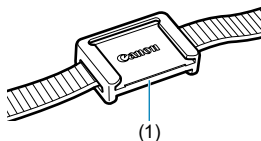

Preparation and Basic Operations

This chapter describes preparatory steps before you start shooting and the basic camera operations.

Charging the Battery

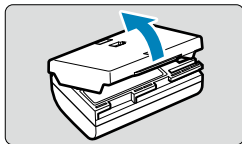

- 1** Detach the protective cover provided with the battery.

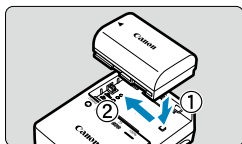

- 2** Insert the battery in the charger.
- Do the opposite to remove the battery.

LC-E6

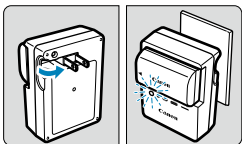

- 3** Recharge the battery.
- For LC-E6**

- As shown by the arrow, flip out the battery charger's prongs and insert the prongs into a power outlet.

For LC-E6E

LC-E6E

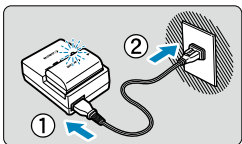

- Connect the power cord to the charger and insert the plug into a power outlet.
- Recharging starts automatically and the charge lamp blinks in orange.

Charge Level	Charge Lamp	
	Color	Display
0–49%	Orange	Blinks once per second
50–74%		Blinks twice per second
75% or higher		Blinks three times per second
Fully charged	Green	Turned on

- **It takes approx. 2 hr. and 30 min. to fully recharge a completely exhausted battery at room temperature (23°C / 73°F).** The time required to charge the battery will vary greatly depending on the ambient temperature and the battery's remaining capacity.
- For safety reasons, charging in low temperatures (5–10°C / 41–50°F) will take longer (up to approx. 4 hr.).

- **Upon purchase, the battery is not fully charged.**
Charge the battery before use.
- **Recharge the battery on the day before or on the day it is to be used.**
Even during storage, a charged battery will gradually drain and lose its capacity.
- **After recharging the battery, remove it and disconnect the charger from the power outlet.**

- **You can attach the protective cover in a different orientation to indicate whether the battery is recharged or not.**

If the battery is recharged, attach the protective cover so that the battery-shaped hole <  > is aligned over the blue sticker on the battery. If the battery is exhausted, attach the protective cover in the opposite orientation.

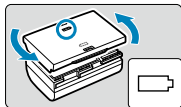

- **When not using the camera, remove the battery.**

If the battery is left in the camera for a prolonged period, a small amount of power current will keep being released, resulting in excess discharge and shorter battery life. Store the battery with the protective cover attached. Storing the battery when it is fully charged may lower the battery performance.

- **The battery charger can also be used in foreign countries.**

The battery charger is compatible with a 100 V AC to 240 V AC 50/60 Hz power source. If necessary, attach a commercially available plug adapter for the respective country or region. Do not attach any portable voltage transformer to the battery charger. Doing so may damage the battery charger.

- **If the battery becomes exhausted quickly even after having been fully charged, the battery has reached the end of its service life.**

Check the battery's recharge performance ( 524) and purchase a new battery.

- After disconnecting the charger's power plug, do not touch the prongs for approx. 10 sec.
- If the battery's remaining capacity ( 524) is 94% or higher, the battery will not be recharged.
- The provided charger cannot charge any battery other than Battery Pack LP-E6N/LP-E6.

Inserting/Removing the Battery

Insert a fully-charged Battery Pack LP-E6N (or LP-E6) into the camera.

Insertion

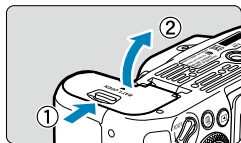

- 1 Slide the battery compartment cover lock and open the cover.**

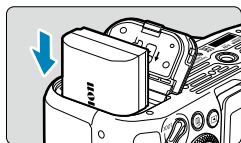

- 2 Insert the battery.**
 - Insert the end with the electrical contacts.
 - Insert the battery until it locks in place.

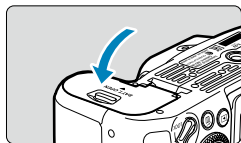

- 3 Close the cover.**
 - Press the cover until it snaps shut.



- You cannot use batteries other than the Battery Pack LP-E6N or LP-E6.

Removal

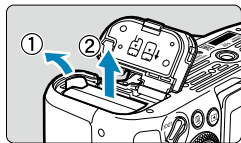

Open the cover and remove the battery.

- Press the battery lock lever as shown by the arrow and remove the battery.
- To prevent short-circuits, always attach the included protective cover (📖 44) to the battery.

Inserting and Removing the Card

The captured images are recorded onto the card.

- Make sure the card's write-protect switch (1) is set upward to enable writing and erasing.

Insertion

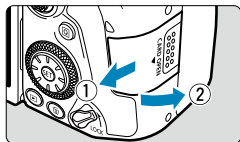

- 1 Slide the cover to open it.

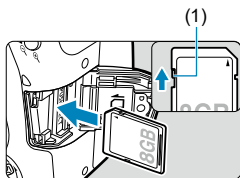

- 2 Insert the card.
 - As shown by the illustration, face the card's label side toward you and insert it until it clicks in place.

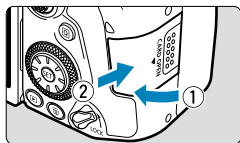

- 3 Close the cover.
 - Close the cover and slide it in the direction shown by the arrows until it snaps shut.

Formatting the Card

If the card is new or was previously formatted (initialized) by another camera or computer, format the card with this camera (📖 511).

Removal

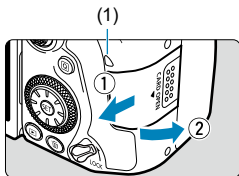

1 Open the cover.

- Set the power switch to <OFF>.
- **Check that the access lamp (1) is off, then open the cover.**
- If **[Saving...]** is displayed on the screen, close the cover.

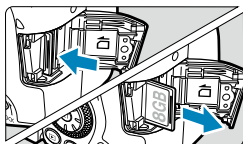

2 Remove the card.

- Gently push in the card, then let it go to eject.
- Pull the card straight out, then close the cover.



- The number of possible shots varies depending on the remaining capacity of the card, the settings of image quality, ISO speed, etc.
- Setting **[📷: Release shutter without card]** to **[Disable]** will prevent you from forgetting to insert a card (📖 205).



- **When the access lamp is lit or blinking, it indicates that images are being written to, read from, or erased from the card, or data is being transferred. Do not open the card slot cover during this time. Also, never do any of the following while the access lamp is lit or blinking. Otherwise, it can damage the image data, card, or camera.**
 - **Removing the card.**
 - **Removing the battery.**
 - **Shaking or striking the camera.**
 - **Unplugging or plugging in a power cord when using household power outlet accessories (sold separately, [book 594](#)).**
- If the card already contains recorded images, the image number may not start from 0001 ([book 507](#)).
- If a card-related error message is displayed on the screen, remove and reinsert the card. If the error persists, use a different card. If you can transfer images on the card to a computer, transfer all the images and then format the card with the camera ([book 511](#)). The card may then return to normal.
- Do not touch the card's contacts with your fingers or metal objects. Do not expose the contacts to dust or water. If smudges adhere to the contacts, contact failure may result.
- Multimedia cards (MMC) cannot be used. (Card error will be displayed.)
- Use of UHS-II microSDHC/SDXC cards with a microSD to SD adapter is not recommended. When using UHS-II cards, use SDHC/SDXC cards.

Using the Screen

You can change the direction and angle of the screen.

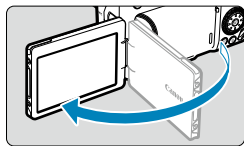

1 Flip out the screen.

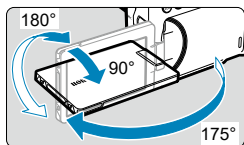

2 Rotate the screen.

- When the screen is swung out, you can rotate it up, down, or over 180° to face the subject.
- The indicated angle is only approximate.

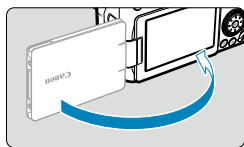

3 Face it toward you.

- Normally, use the camera with the screen facing you.



- Be careful not to forcefully rotate the screen, putting much power on the rotating axis (hinge).
- When a cable is connected to a camera terminal, the rotation angle range of the flipped-out screen will be limited.



- When not using the camera, close the screen facing inward. You can protect the screen.

Turning on the Power

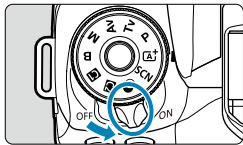

- <ON>
The camera turns on.
- <OFF>
The camera is turned off and does not function. Set the power switch to this position when not using the camera.

Setting the Date, Time, and Time Zone

If you turn on the power switch and the date/time/zone setting screen appears, see 516 to set the date/time/zone.

Changing the Interface Language

To change the interface language, see 519.

Automatic Sensor Cleaning

- Whenever you set the power switch to <ON> or <OFF>, sensor cleaning will be performed automatically. (A small sound may be audible.) During the sensor cleaning, the screen will display < >.
- If you repeatedly turn the power switch <ON>/<OFF> at a short interval, the < > icon may not be displayed. This is normal and not a malfunction.







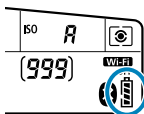

- If you set the power switch to <OFF> while an image is being recorded to the card, [**Saving...**] will be displayed and the power will turn off after the recording finishes.

Battery Level Indicator

When the power switch is set to <ON>, the battery level will be indicated.





Display			
Level (%)	100-70	69-50	49-20

Display			
Level (%)	19-10	9-1	0



- Doing any of the following will exhaust the battery faster:
 - Pressing the shutter button halfway for a prolonged period.
 - Activating the AF frequently without taking a picture.
 - Using the lens's Image Stabilizer.
 - Using the Wi-Fi function or Bluetooth function.
 - Using the screen frequently.
- The number of possible shots may decrease depending on the actual shooting conditions.
- The lens operation is powered by the camera's battery. Certain lenses may exhaust the battery faster than others.
- In low ambient temperatures, shooting may not be possible even with a sufficient battery level.



- See [ **Battery info.**] to check the battery status ( 524).

Attaching and Detaching a Lens

All EF and EF-S lenses can be used. The camera cannot be used with RF or EF-M lenses.

Attaching a Lens

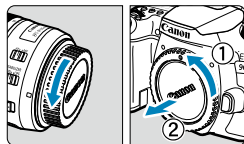

1 Remove the caps.

- Remove the rear lens cap and the body cap by turning them as shown by the arrows.

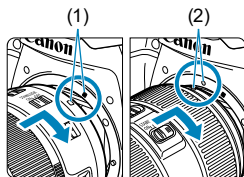

2 Attach the lens.

- Align the white or red mount index on the lens with the corresponding mount index on the camera and turn the lens as shown by the arrow until it clicks into place.

- (1) White index
- (2) Red index

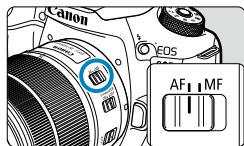

3 Set the lens's focus mode switch to <AF>.

- <AF> stands for autofocus.
- <MF> stands for manual focus. Autofocus will not operate.

4 Remove the front lens cap.

Detaching the Lens

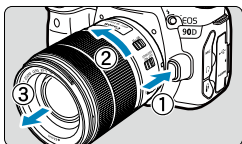

While pressing the lens release button, turn the lens as shown by the arrow.

- Turn the lens until it stops, then detach it.
- Attach the rear lens cap to the detached lens.



- Do not look at the sun directly through any lens. Doing so may cause loss of vision.
- When attaching or detaching a lens, set the camera's power switch to <OFF>.
- If the front part (focusing ring) of the lens rotates during autofocus, do not touch the rotating part.



- For instructions on how to use the lens, refer to the Lens Instruction Manual (4).

Shooting angle of view

Because the image area is smaller than 35mm film format, the effective angle of view corresponds to approx. 1.6 times the lens's indicated focal length.



- Image area (approx.)
(22.3×14.8 mm / 0.88 x 0.58 in.)
- 35mm film format
(36×24 mm / 1.42 x 0.94 in.)

Tips for Avoiding Smudges and Dust

- When changing lenses, do it quickly in a place with minimal dust.
- When storing the camera without a lens attached, be sure to attach the body cap to the camera.
- Remove dust on the body cap before attaching it.

Basic Operations

Adjusting the Viewfinder

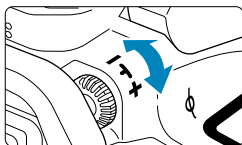

- Turn the dioptic adjustment knob left or right so that the AF points in the viewfinder look sharp.
- If the knob is difficult to turn, remove the eyecup (📖 157).

- If the camera's dioptic adjustment still cannot provide a sharp viewfinder image, using E-series Dioptic Adjustment Lenses (sold separately) is recommended.

Holding the Camera

To obtain sharp images, hold the camera still to minimize camera shake.

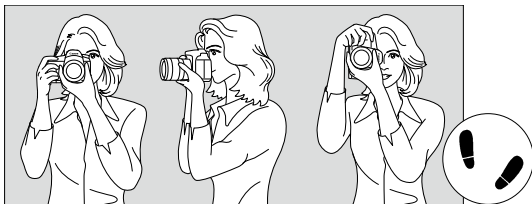

Horizontal shooting

Vertical shooting

1. Wrap your right hand around the camera grip firmly.
2. Hold the lens bottom with your left hand.
3. Rest your right index finger lightly on the shutter button.
4. Press your arms and elbows lightly against the front of your body.
5. To maintain a stable stance, place one foot slightly ahead of the other.
6. Press the camera against your face and look through the viewfinder.

- To shoot while looking at the screen, see 📖 71.

Shutter Button

The shutter button has two steps. You can press the shutter button halfway. Then you can further press the shutter button completely.

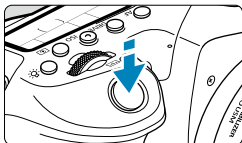

Pressing Halfway

This activates autofocus and the automatic exposure system that sets the shutter speed and aperture.

The exposure setting (shutter speed and aperture) is displayed in the viewfinder and on the LCD panel for approx. 4 sec. (metering timer/ⓘ4).

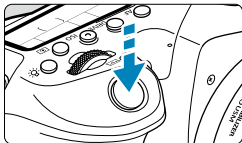

Pressing Completely

This releases the shutter and takes the picture.

● Preventing Camera Shake

Hand-held camera movement during the moment of exposure is called camera shake. It can cause blurred pictures. To prevent camera shake, note the following:

- Hold and steady the camera as shown on the preceding page.
- Press the shutter button halfway to autofocus, then slowly press the shutter button completely.



- If you press the shutter button completely without pressing it halfway first, or if you press the shutter button halfway and then press it completely immediately, the camera will take a moment before it takes the picture.
- Even during menu display or image playback, you can go back to shooting-ready state by pressing the shutter button halfway.

Mode Dial

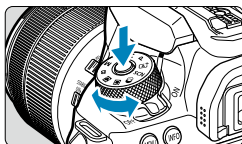

Turn the dial while holding down the lock-release button at the center of the dial.

Use it to set the shooting mode.



Main Dial

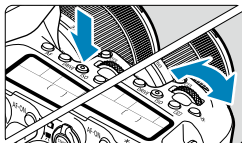

(1) After pressing a button, turn the <Main Dial> dial.

When you press a button such as <AF>, <DRIVE>, <ISO>, or <LOCK>, the respective function remains selectable for approx. 6 sec. (ⓘ6). During this time, you can turn the <Main Dial> dial to change the setting.

When the timer ends or if you press the shutter button halfway, the camera will go back to shooting-ready state.

- Use this dial to select the AF operation, drive mode, ISO speed, metering mode, AF point, etc.

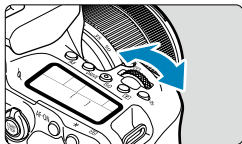

(2) Turn only the <Main Dial> dial.

While looking at the viewfinder display or LCD panel, turn the <Main Dial> dial.



- Use this dial to set the shutter speed, aperture value, etc.

- The operations in (1) can be performed even when the <LOCK> switch is set upward (Multi-function lock, ⓘ60).

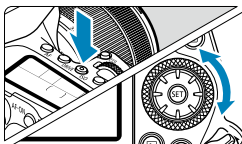
Quick Control Dial



(1) After pressing a button, turn the dial.

When you press a button such as **<AF>**, **<ISO>**, or **<>**, the respective function remains selectable for approx. 6 sec. (ⓘ6). During this time, you can turn the  dial to change the setting.

When the timer ends or if you press the shutter button halfway, the camera will go back to shooting-ready state.

- Use this dial to select the AF operation, ISO speed, metering mode, AF point, etc.

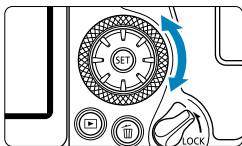

(2) Turn only the dial.

While looking at the viewfinder display or LCD panel, turn the  dial.



- Use this dial to set the exposure compensation amount, the aperture setting for manual exposures, etc.

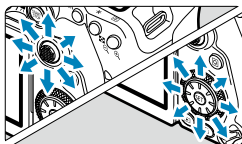

- The operations in (1) can be performed even when the **<LOCK>** switch is set upward (Multi-function lock, ⓘ60).

Multi-Controller 1 / Multi-Controller 2





-  is an eight-direction key with center button. To use it, press lightly with the tip of your thumb.
-  is an eight-direction key.
- Used for operations such as AF point selection, white balance correction, AF point/magnifying frame movement in Live View shooting or movie recording, magnifying frame movement during playback, or Quick Control settings.
- Can also be used to select or set menu items.
-  can also be used for image browsing during playback.

-  • Correcting the white balance and moving the magnifying frame during playback can be done even with the <LOCK> switch set upward (Multi-function lock).



LOCK Multi-Function Lock

With [: Multi function lock] set and the <LOCK> switch set upward, you can prevent the settings from being changed by accidentally operating Main dial, Quick control dial, or Multi-controller or by inadvertently tapping on the touch-screen panel.

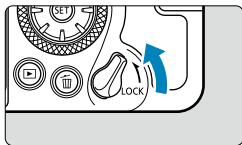
For [: Multi function lock] details, see  545.





- <LOCK> switch set upward: Lock engaged
- <LOCK> switch set downward: Lock released

-  • By default, the  dial will be locked when the multi-function lock switch is in the lock position.

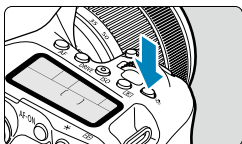
LCD Panel Illumination





You can illuminate the LCD panel by pressing the  button. Turn on () or off the LCD panel illumination by pressing the  button.

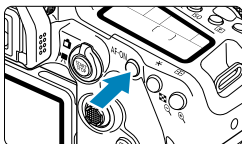

- During a bulb exposure, pressing the shutter button completely will turn off the LCD panel illumination.

AF-ON Button



In still photo shooting, has the same effect as pressing the shutter button halfway, in Creative Zone modes ( 57).

In movie recording as well, enables autofocusing in Creative Zone modes.

INFO button

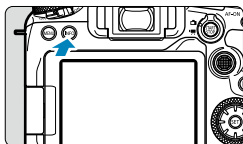

Each press of the <INFO> button changes the information shown.

The following sample screens are for still photos.

When the Quick Control screen is displayed, you can press the <Q> button and configure shooting functions directly (67).

In viewfinder shooting

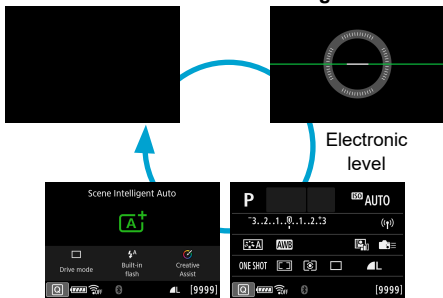

Quick Control screen

In Live View shooting

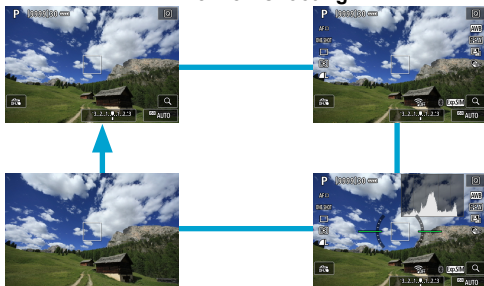

Menu Operations and Settings

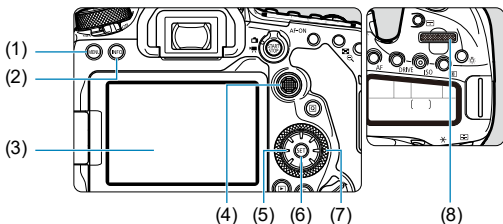

(1) <MENU> button

(2) <INFO> button

(3) Screen

(4) <Multi-controller 1>

(5) <Multi-controller 2>

(6) <SET> button

(7) <Quick control dial>

(8) <Main dial>

Basic Zone Modes Menu Screen

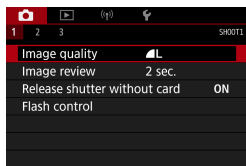

* In Basic Zone modes, some tabs and menu items do not appear.

Creative Zone Modes Menu Screen

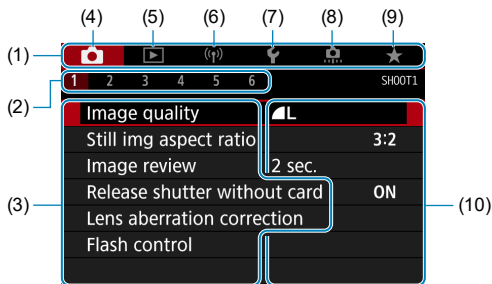

(1) Main tabs

(2) Secondary tabs

(3) Menu items

(4) : Shooting

(5) : Playback

(6) : Wireless features

(7) : Set-up

(8) : Custom Functions

(9) : My Menu

(10) Menu settings

Menu Setting Procedure

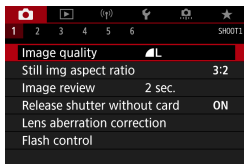

1 Display the menu screen.

- Press the **<MENU>** button.

2 Select a tab.

- Each time you press the **<Q>** or **<INFO>** button, the main tab (group of functions) will switch.
- Turn the **<DIAL>** to select a secondary tab.

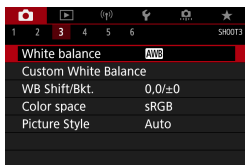

3 Select an item.

- Turn the <DIAL> dial to select an item, then press <SET>.

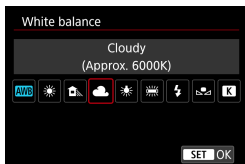

4 Select an option.

- Turn the <DIAL> dial to select an option.
- The current setting is indicated in blue.

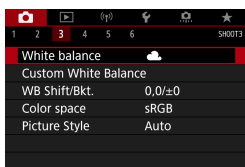

5 Set an option.

- Press <SET> to set it.

6 Exit the setting.

- Press the <MENU> button to finish and prepare for shooting.



- The description of menu functions hereafter assumes that you have pressed the <MENU> button to display the menu screen.
- You can also tap on the menu screen or use <DIAL> <DIAL> to operate the menu.
- To cancel the operation, press the <MENU> button.

Dimmed Menu Items

Example: Highlight tone priority

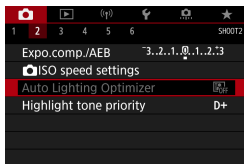

Dimmed menu items cannot be set. The menu item is dimmed if another function setting is overriding it.

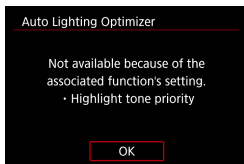

You can see the overriding function by selecting the dimmed menu item and pressing $\langle \text{SET} \rangle$.

If you cancel the overriding function's setting, the dimmed menu item will become settable.

- You may not be able to see the overriding function for certain dimmed menu items.

- With [**⚙**: **Clear all camera settings**], you can reset the menu functions to the default settings (📖 547).

Quick Control

You can directly select and set the settings displayed on the screen.

In Viewfinder Shooting

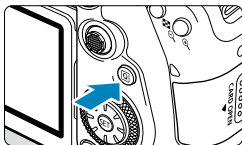

1 Press the <Q> button (10).

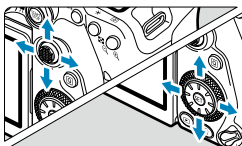

2 Select a setting item.

- Press the <▲> <▼> <◀> <▶> keys for selection.

Creative Zone

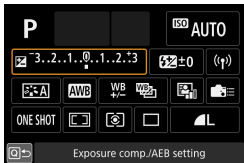

- Press <SET>.
- Some items can be set by turning the <DIAL> or <DIAL> dial without pressing <SET>.

Basic Zone

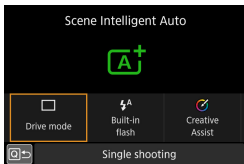

During Playback

1 Press the **<Q>** button (📷10).

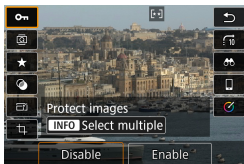

2 Select a setting item.

- Press the **<▲>** **<▼>** keys for selection.

3 Select an option.

- Turn the **<☀>** or **<🌙>** dial, or press the **<◀>** **<▶>** keys to change the setting. Some items are set by pressing a button after this.
- Configure items labeled with a **[SET]** icon on the bottom of the screen by pressing **<SET>**.
- To cancel this operation, press the **<MENU>** button.
- Press the **<Q>** button to return to the previous screen.



- Before rotating images, set **[ψ: Auto rotate]** to **[On 📷]** (📖 349). When **[ψ: Auto rotate]** is set to **[On 📷]** or **[Off]**, images will be tagged with your selected **[📷 Rotate image]** option but not rotated on the camera.



- Pressing the **<Q>** button during index display will switch to single-image display and show the Quick Control screen. Pressing the **<Q>** button again returns to index display.
- For images from other cameras, available options may be restricted.

Touch-Screen Operation

Tap

Sample screen (Quick Control)

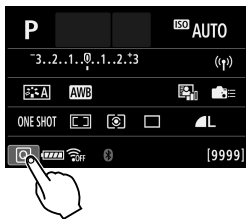

- Use your finger to tap on (touch briefly and then remove your finger from) the screen.
- For example, when you tap on [Q], the Quick Control screen appears. By tapping on [Q↵], you can return to the preceding screen.

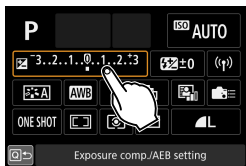

Drag

Sample screen (Menu screen)

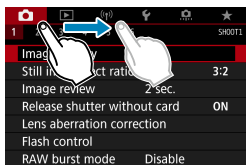

- Slide your finger while touching the screen.

- If [🔊: Beep] is set to [Touch 🔊] or [Disable], the beep will not sound for touch operations (📖 522).
- Touch control settings can be adjusted in [🔊: Touch control] (📖 521).

Viewing the Screen as You Shoot (Live View Shooting)

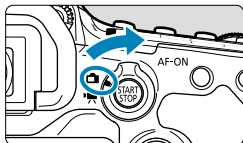

- 1** Set the Live View shooting/Movie shooting switch to .

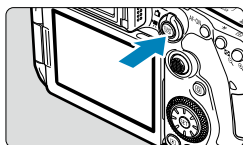



- 2** Display the Live View image.

- Press the  button.
- The Live View image will be displayed in the brightness level closely matching that of the actual image to be captured.



- 3** Focus on the subject.

- Press the shutter button halfway to focus.
- If  blinks, press the  button to raise the built-in flash.
- You can also tap on the screen to select the face or subject ( 72).

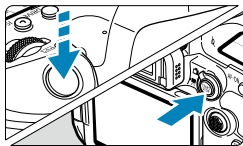

- 4** Take the picture.

- Press the shutter button completely.
- Press the  button to exit Live View shooting.

Shooting with the Touch Shutter

Just by tapping on the screen, you can focus and take the picture automatically.



1 Enable the Touch Shutter.

- Tap **[OFF]** on the screen's bottom left. Each time you tap on the icon, it will toggle between **[OFF]** and **[ON]**.
- **[ON]** (Touch Shutter: Enable)
The camera will focus on the spot you tap on, then the picture will be taken.
- **[OFF]** (Touch Shutter: Disable)
You can tap on a spot to perform focusing on the spot. Press the shutter button completely to take the picture.



2 Tap on the screen to shoot.

- Tap on the face or subject on the screen. On the point you tap, the camera will focus (Touch AF) with the AF method that was set (135–136).
- When **[ON]** is set, the AF point turns green when focus is achieved, then the picture is taken automatically.
- If focus is not achieved, the AF point turns orange and the picture cannot be taken. Tap on the face or subject on the screen again.



- The camera shoots in single shooting mode regardless of the drive mode setting.
- Tapping the screen focuses with **[One-Shot AF]** regardless of the AF operation setting.
- Tapping on the screen in magnified view will not focus or take the picture.
- Regardless of where you tap to shoot with the Fish-eye effect Creative filter, your shots will be in focus at the AF point in the center of the screen.
- Touch Shutter has no effect when you shoot with the Miniature effect Creative filter.
- If you shoot with [: **Image review**] set to **[Hold]**, you can press the shutter button halfway to take the next shot.



- In bulb exposures, tap once to start exposure and again to stop exposure. Be careful not to shake the camera when tapping on the screen.



Basic Zone

This chapter describes how to use the Basic Zone modes on the Mode dial for best results.

With Basic Zone modes, all you do is point and shoot, and the camera sets everything automatically.

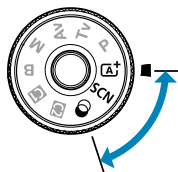
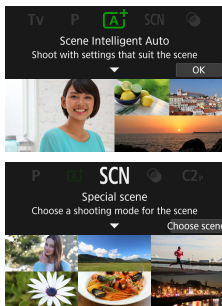

Fully Automatic Shooting (Scene Intelligent Auto)

<A+> is a fully automatic mode. The camera analyzes the scene and sets the optimum settings automatically. It can also adjust focus automatically on either the still or moving subject by detecting the motion of the subject (📖 80).



1 Set the Mode dial to <A+>.

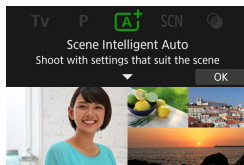

2 Press <SET>.

- Read the message and select [OK].

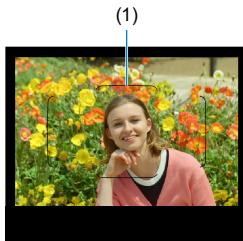

3 Aim the camera at what you will shoot (the subject).

- Essentially, the camera focuses on the closest subject.
- In viewfinder shooting, you can assist with focusing by centering the Area AF frame (1) over the subject.
- In Live View shooting, when a frame (AF point) appears on the screen, aim it over the subject.

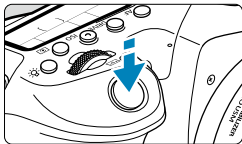

4 Focus on the subject.

- Press the shutter button halfway to focus.
If $\langle \text{flash icon} \rangle$ blinks, press the $\langle \text{flash icon} \rangle$ button to raise the built-in flash.

With viewfinder shooting

- When achieving focus, the AF point that has achieved focus will be displayed. At the same time, the beeper will sound and the focus indicator $\langle \bullet \rangle$ in the viewfinder will light up. In low light, the AF point(s) will light up briefly in red.
- Under low light, the AF-assist beam (continuous flash) fires automatically as needed when the built-in flash is raised.

With Live View shooting

- Once the subject is in focus, that AF point turns green and the camera beeps.
- The AF point in focus on a moving subject turns blue and tracks subject movement. The camera does not beep.

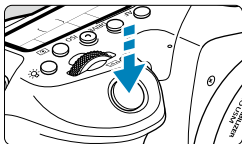

5 Take the picture.

- Press the shutter button completely to take the picture.
- The image just captured will be displayed for approx. 2 sec. on the screen.
- To retract the built-in flash, push it down with your fingers.

- Subject movement (whether subjects are still or moving) may not be detected correctly for some subject or shooting conditions.

- The $\langle \text{A}^+ \rangle$ mode makes the colors look more impressive in nature, outdoor, and sunset scenes. If you do not obtain the desired color tones, change the mode to a Creative Zone mode (📖 39) and select a Picture Style other than $\langle \text{P-A} \rangle$, then shoot again (📖 230).

Minimizing Blurred Photos

- Be careful about camera shake in handheld shots. To avoid camera shake, consider using a tripod. Use a sturdy tripod that can bear the weight of the shooting equipment. Attach the camera securely to the tripod.
- Using a remote switch (sold separately, 📖 156) or a wireless remote control (sold separately, 📖 155) is recommended.

FAQ

- **Focusing is not possible (indicated by a blinking $\langle \bullet \rangle$ in the viewfinder, in viewfinder shooting, or by an orange AF point in Live View shooting).**

Aim the AF point over an area with good contrast, then press the shutter button halfway (📖 57). If you are too close to the subject, move away and shoot again.

- **Multiple AF points are displayed simultaneously.**
Focus has been achieved at all those points.
- **Pressing the shutter button halfway does not focus the subject.**

If the focus mode switch on the lens is set to $\langle \text{MF} \rangle$, set it to $\langle \text{AF} \rangle$.

- **The shutter speed display is blinking.**
Since it is too dark, taking the picture may result in a blurred subject due to camera shake. Using a tripod, the built-in flash, or an external flash (📖 179) is recommended.

- **Pictures are too dark.**

Raise the built-in flash to enable automatic flash firing, in case subjects in daytime shots are backlit, or when shooting under low light.

- **The built-in flash fired repeatedly when raised while shooting under low light.**

To make autofocusing easier, the built-in flash may fire repeatedly when you press the shutter button halfway (📖 126).

- **Pictures taken with flash are too bright.**

Pictures may be bright (overexposed) if you shoot subjects at close range in flash photography. Move away from the subject and shoot again.

- **The bottom part of pictures taken with flash is unnaturally dark.**

Shooting subjects that are too close may make the shadow of the lens visible in your shots. Move away from the subject and shoot again. Also remove the lens hood before shooting.



Note the following if you are not using the built-in flash.

- Under low light where camera shake tends to occur, the viewfinder's shutter speed display will blink. Hold the camera steady or use a tripod. When using a zoom lens, you can reduce the blur caused by camera shake by setting the lens to the wide-angle end.
- When shooting portraits under low light, tell subjects to stay still until you have finished shooting. Any movement as you shoot will make the person look blurry in the picture.

Recomposing the Shot



Depending on the scene, positioning the subject toward the left or right to include a balanced background will result in a picture with better perspective.

Pressing the shutter button halfway to focus on a still subject will lock the focus on that subject. Recompose the shot while keeping the shutter button pressed halfway, and then press the shutter button completely to take the picture. This is called “focus lock”.

-  In Live View shooting, the camera continues to focus on any faces initially detected and focused on, even if you recompose the shot.

Shooting a Moving Subject



Pressing the shutter button halfway tracks moving subjects to keep them in focus.

Keep the subject in the Area AF frame (in viewfinder shooting) or on the screen (in Live View shooting) as you hold down the shutter button halfway, and at the decisive moment, press the shutter button completely.

Scene Icons



The camera detects the scene type and sets everything automatically to suit the scene. In Live View shooting, an icon representing the type of scene detected appears in the upper left of the screen (📖 627).

Adjusting Settings

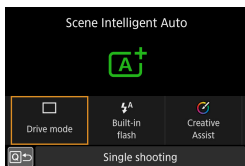

In viewfinder shooting, you can adjust drive mode, built-in flash firing, and Creative Assist settings by pressing the <[Q]> button.



In Live View shooting, you can adjust image quality, Touch Shutter, and Creative Assist settings by touching icons.

Shooting with Effects Applied (Creative Assist)

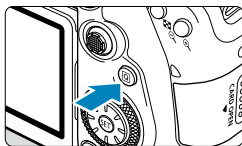
1 Press the **<Q>** button.

- In viewfinder shooting, use the **<◀>** **<▶>** keys to select **[Creative Assist]**, then press **<SET>**.
- In Live View shooting, read the message and select **[OK]**.

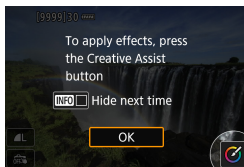

2 Select an effect.

- Use the **<◀>** **<▶>** keys to select an effect, then press **<SET>**.
- You can also turn the **<☀>** or **<🕒>** dial to select it.

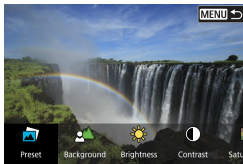

3 Select the effect level and other details.

- Use the **<◀>** **<▶>** keys to set it, then press **<SET>**.
- To reset the setting, press the **<✳>** button, then select **[OK]**.
- You can also turn the **<☀>** or **<🕒>** dial to set it.

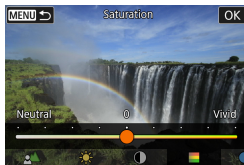

Creative Assist Effects

● **[🖼️] Preset**

Select one of the preset effects.

Note that **[Saturation]**, **[Color tone 1]**, and **[Color tone 2]** are not available with **[B&W]**.

-  **Background blur**

Adjust background blur. Choose higher values to make backgrounds sharper, or lower values to make them blurrier. **[Auto]** adjusts background blurring to match the brightness. Depending on lens brightness (f/ number), some positions may not be available.

-  **Brightness**

Adjust image brightness.

-  **Contrast**

Adjust contrast.

-  **Saturation**

Adjust the vividness of colors.

-  **Color tone 1**

Adjust amber/blue color tone.

-  **Color tone 2**

Adjust green/magenta color tone.

-  **Monochrome**

Set the toning effect for monochrome shooting.



- **[Background blur]** is not available when the flash is used.
- These settings are reset when you switch shooting modes or set the power switch to <OFF>. To save the settings, set **[☑: Retain Creative Assist data]** to **[Enable]**.

Saving Effects

To save the current setting to the camera, press the <INFO> button on the Creative Assist setting screen, then select **[OK]**. Up to three presets can be saved as **[USER*]**. After three have been saved, an existing **[USER*]** preset must be overwritten to save a new one.

Special Scene Mode

The camera will automatically choose the appropriate settings when you select a shooting mode for your subject or scene.

* <SCN> stands for Special Scene.



1 Set the Mode dial to <SCN>.

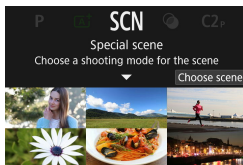

2 Press <SET>.

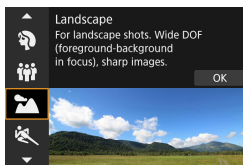

























3 Select a shooting mode.

- Press the <▲> <▼> keys to select the shooting mode, then press <SET>.
- Selection is also possible by turning the <⚙> or <⌚> dial.

! ● Cautions on each shooting mode are listed together (📖 99). Read the cautions before shooting.

📄 ● When [🔧: Mode guide] is set to [Disable], after step 1, press the <Q> button, use the <◀> <▶> keys to select [Choose scene], use the <▲> <▼> keys to select a shooting mode, then press <SET>.

Available Shooting Modes in the SCN Mode

Shooting Mode		Page	Shooting Mode		Page
	Portrait	 86		Close-up	 93
	Group Photo	 87		Food	 94
	Landscape	 88		Candlelight	 95
	Sports	 89		Night Portrait	 96
	Kids	 90		Handheld Night Scene	 97
	Panning	 91		HDR Backlight Control	 98



- Live View shooting is not available in mode.

Shooting Portraits

The (Portrait) mode blurs the background to make the human subject stand out. It also makes skin tones and hair look softer.

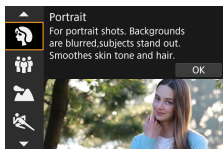

Shooting Tips

- **Select the location where the distance between the subject and the background is the farthest.**

The further the distance between the subject and background, the more blurred the background will look. The subject will also stand out better against an uncluttered dark background.

- **Use a telephoto lens.**

If you have a zoom lens, use the telephoto end to fill the frame with the subject from the waist up.

- **Focus on the face.**

As you focus before shooting, make sure that an AF point is displayed on the face (in viewfinder shooting), or that the AF point on the face is green (in Live View shooting). When shooting close-ups of the face in Live View shooting, you can set [: **Eye Detection AF**] to [**Enable**] to shoot with the subject's eyes in focus.

- **Shoot continuously.**

The default setting is (Low-speed continuous shooting). If you keep holding down the shutter button, you can shoot continuously to capture changes in the subject's facial expression and pose.

Shooting Group Photos

Use the <iii> (Group Photo) mode to shoot group photos. You can take a picture in which both the people in the front and people in the back are all in focus.

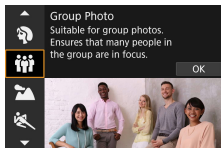

Shooting Tips

● Use a wide-angle lens.

When using a zoom lens, use the wide-angle end to make it easy to get all the people in the group in focus at once, from the front row to the back. Also, if you place a little distance between the camera and the subjects (so that the subjects' entire bodies are in the shot), the focus range increases in depth.

● Take multiple shots of the group.

It is recommended to shoot multiple photos in case some people close their eyes.



- Using a tripod is recommended when shooting indoors or under low light.

Shooting Landscapes

Use the (Landscape) mode for expansive scenery or to have everything in focus from near to far. For vivid blues and greens, and sharp and crisp images.

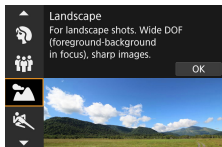

Shooting Tips

- **With a zoom lens, use the wide-angle end.**

When using a zoom lens, set the lens to the wide-angle end to make the objects near and far in focus. It also adds breadth to landscapes.

- **Keep the camera steady when shooting night scenes.**

Using a tripod is recommended.

Shooting Moving Subjects

Use the <🏃> (Sports) mode to shoot a moving subject, such as a running person or a moving vehicle.

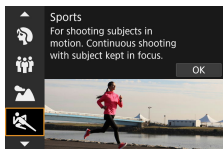

Shooting Tips

- **Use a telephoto lens.**

Use of a telephoto lens is recommended to enable shooting from a distance.

- **Track the subject with the Area AF frame.**

In viewfinder shooting, aim the Area AF frame over the subject and press the shutter button halfway to start focusing. During autofocusing, the beeper will continue beeping softly. If focus cannot be achieved, the focus indicator <●> will blink.

In Live View shooting, an Area AF frame appears after you press the shutter button halfway. Once the subject is in focus, the AF point turns blue.

- **Shoot continuously.**

The default setting is <📷H> (High-speed continuous shooting). At the decisive moment, press the shutter button completely to take the shot. To track the subject and capture changes as it moves, keep holding down the shutter button to shoot continuously.

Photographing Children

To photograph the children running around, use the <👦> (Kids) mode. Skin tones will look healthy.



Shooting Tips

● Track the subject with the Area AF frame.

In viewfinder shooting, aim the Area AF frame (1) over the subject and press the shutter button halfway to start focusing. During autofocusing, the beeper will continue beeping softly. If focus cannot be achieved, the focus indicator <●> will blink.

In Live View shooting, an Area AF frame (2) appears after you press the shutter button halfway. Once the subject is in focus, the AF point turns blue.



● Shoot continuously.

The default setting is <📷H> (High-speed continuous shooting). At the decisive moment, press the shutter button completely to take the shot. To track the subject and capture changes in facial expression and movement, keep holding down the shutter button to shoot continuously.

● When <⚡> blinks

Press the <⚡> button to raise the built-in flash.

Panning

If you want to take a picture with the feel of speed and a blurred motion effect on the subject's background, use the  (Panning) mode. If you use a lens supporting the  mode, subject blur is detected, corrected, and reduced.

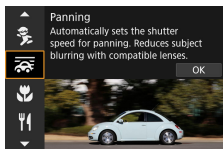

Shooting Tips

● Turn the camera to follow the moving subject.

When shooting, turn the camera smoothly as you track the moving subject. Aim the AF point over the part of the moving subject where you want to focus, then press the shutter button halfway and keep holding it down as you turn the camera to match the subject's speed and movement. Press the shutter button completely while moving the camera to take the picture. Keep tracking the subject with the camera.

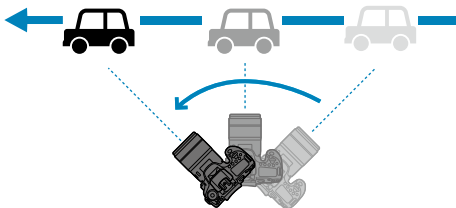



● Set the level of background motion blur.

With **[Effect]**, you can set the level of background motion blur. The **[Max]** setting will set a slower shutter speed to increase the background motion blur around the subject. If the subject blur is noticeable, set **[Effect]** to **[Med]** or **[Min]** to reduce the blur.

● Shoot continuously.

By default,  (Continuous shooting) is set. At the decisive moment, press the shutter button completely to take the picture. You can track moving subjects by panning the camera as you keep holding down the shutter button to shoot continuously.



- To see which lenses support the  mode, refer to the Canon website.
- With lenses that support  mode, the camera automatically corrects subject blur and (based on the **[Effect]** setting) adjusts shutter speed, regardless of the lens IS setting.
- The AF Area selection mode's default setting is Zone AF with the center of the screen selected.
- The AF method can only be set to **[1-point AF]** or **[Zone AF]**. By default, it is set to **[Zone AF]**, with the zone in the center of the screen selected.
- To prevent camera shake, it is recommended that you hold the camera with both hands, tighten your arms close to your body, and track the subject's movement smoothly to take pictures.
- This effect is most effective with trains, cars, etc. that move at a constant speed in one direction.
- Taking test shots or checking the image by playing it back immediately after shooting is recommended.
- With telephoto lenses, be careful about camera shake and subject blur. To avoid camera shake, consider using a tripod or monopod.

Shooting Close-ups

When you want to shoot flowers or small things up close, use the <🌸> (Close-up) mode. To make small things appear much larger, use a macro lens (sold separately).

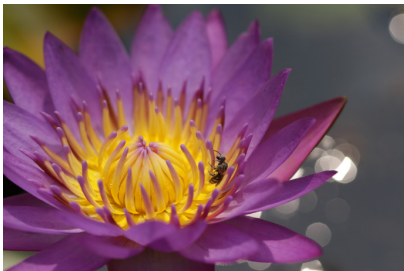
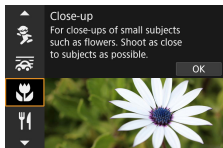

Shooting Tips

- **Use a simple background.**

A simple background makes small objects such as flowers stand out better.

- **Move in as close as possible to the subject.**

Check the lens for its minimum focusing distance. The lens minimum focusing distance is measured from the <⊖> (focal plane) mark on the top of the camera to the subject. Focusing is not possible if you are too close.

- **With a zoom lens, use the telephoto end.**

If you have a zoom lens, using the telephoto end will make the subject look larger.

- **When <🔦> blinks**

Press the <🔦> button to raise the built-in flash.

Shooting Food

When you want to take pictures of food, use the <¶¶> (Food) mode. The photo will look bright and appetizing. Also, depending on the light source, the reddish tinge will be suppressed in the pictures taken under tungsten lights, etc.

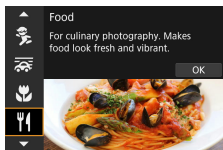

Shooting Tips

● Change the color tone.

You can change **[Color tone]**. To increase the food's reddish tinge, set it toward **[Warm]** (red). Set it toward **[Cool]** (blue) if it looks too red.

Shooting Candlelight Portraits

When you want to photograph a person in candlelight, use the  (Candlelight) mode. The atmosphere of candlelight is reflected in the color tones of the picture.



Shooting Tips

- **Use the center AF point to focus.**

Aim the center AF point in the viewfinder on the subject, then shoot.

- **Prevent camera shake if the numeric display (shutter speed) in the viewfinder blinks.**

Under low light where camera shake tends to occur, the viewfinder's shutter speed display will blink. When using a zoom lens, consider zooming out and either holding the camera steady or using a tripod.

When using a zoom lens, you can reduce the blur caused by camera shake by setting the lens to the wide-angle end.

- **Change the color tone.**

You can change **[Color tone]**. To increase the candlelight's reddish tinge, set toward **[Warm tone]** (red), or set toward **[Cool tone]** (blue) if it looks too red.

- **Adjust brightness.**

You can change **[Brightness]**. To brighten the image, set toward +, or set toward – if the image is too bright.



- The AF method can only be set to **[1-point AF]**.

Shooting Night Portraits (With a Tripod)

When you want to photograph people at night and obtain a natural-looking night scene in the background, use the **<Fn>** (Night Portrait) mode. **Note that shooting in this mode requires the built-in flash or an external Speedlite.** Using a tripod is recommended.

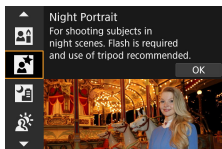

Shooting Tips

- **Use a wide-angle lens and a tripod.**

When using a zoom lens, use the wide-angle end to obtain a wide night view. Because camera shake occurs in handheld shooting, using a tripod is also recommended.

- **Check the image brightness.**

It is recommended to play back the captured image on location to check the image brightness. If the subject looks dark, move nearer and shoot again.

- **Also shoot in other shooting modes.**

Since camera shake is prone to occur with night shots, shooting also with **<A+>** and **<P>** modes is recommended.

-  ● If you use the self-timer together with a flash, the self-timer lamp will light up briefly after the picture is taken.

Handheld Shooting of Night Scenes

The  (Handheld Night Scene) mode enables you to shoot night scenes even while handholding the camera. In this shooting mode, four shots are taken consecutively for each picture, and the resulting one image with reduced camera shake is recorded.

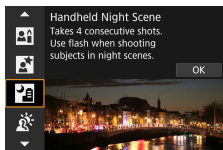

Shooting Tips

- **Hold the camera steady.**

Keep your elbows close to your body to hold the camera steady ( 56). In this mode, four shots are aligned and merged into a single image. However, if there is significant misalignment in any of the four shots due to camera shake, they may not align properly in the final image.

- **For portraits, use flash.**

If your shots will include people, use the built-in flash or an external Speedlite. To take a nice portrait, the first shot will use flash. Tell the subject not to move until all four consecutive shots are taken.

Shooting Backlit Scenes

When shooting a scene having both the bright and dark areas, use the <  > (HDR Backlight Control) mode. When you take one picture in this mode, three consecutive shots are taken at different exposures. This results in one image, with a wide tonal range, that has minimized the clipped shadows caused by backlighting.

* HDR stands for High Dynamic Range.

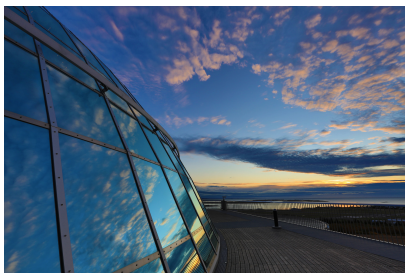
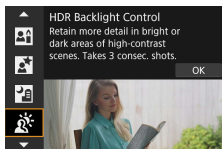

Shooting Tips

● Hold the camera steady.

Keep your elbows close to your body to hold the camera steady ( 56).

In this mode, three shots are aligned and merged into a single image.

However, if there is significant misalignment in any of the three shots due to camera shake, they may not align properly in the final image.

Cautions for the <SCN> Modes



: Group Photo

- The angle of view changes slightly, due to distortion correction.
- Depending on the shooting conditions, focus may not be attained for everyone from the front to the back of the image.

: Landscape

- The built-in flash will not fire, even if it is raised when you shoot.
- Speedlites will not fire either, if used.

: Sports

- Under low light where camera shake tends to occur, the shutter speed value in the lower left will blink. Hold the camera steady and shoot.
- Using a flash will decrease the continuous shooting speed.

: Kids

- Continuous shooting speed is slower when a flash fires during continuous Live View shooting. The camera keeps shooting at the lower continuous shooting speed even after the flash stops firing.

: Panning

- The shutter speed will become slower. Therefore, this mode is not suitable for any shooting except for panning.
- <□H> or <□S> cannot be selected.
- Flash photography is not possible.
- Although lens IS is applied to images captured with lenses supporting <☞> mode, the effect is not shown in the viewfinder or on the screen as you shoot. (IS and subject blur correction are activated when you shoot, regardless of the lens IS setting.)
- If the lens does not support the <☞> mode, subject blur will not be corrected. However, the automatic shutter speed adjustment alone will take effect according to the setting of [Effect].
- When shooting under bright light such as a sunny summer day or when shooting a slow subject, the set degree of panning effect may not be obtained.



: Panning (continued)

- With a lens supporting the < > mode, subject blur may not be corrected properly when shooting the following subjects or under the following shooting conditions.
 - Subjects with very low contrast.
 - Subjects in low light.
 - Strongly backlit or reflective subjects.
 - Subjects with repetitive patterns.
 - Subjects with less patterns or monotonous patterns.
 - Subjects with reflections (images reflected in glass, etc.).
 - Subjects smaller than the Zone AF frame.
 - When there are multiple subjects moving within the Zone AF frame.
 - Subjects moving in irregular directions or at irregular speeds.
 - Subjects whose movements are partly irregular. (For example, the vertical movement of a runner.)
 - Subjects whose speed changes dramatically. (For example, right after the start of movement or while turning along a curve.)
 - When you move the camera too fast or too slow.
 - When the camera's movement does not match the subject's movement.
 - When the lens focal length is long.

: Food

- The warm color cast of subjects may fade.
- When multiple light sources are included in the scene, the warm color cast of the picture may not be reduced.
- If you use a flash, **[Color tone]** will be set to Standard.
- If there are people in the picture, the skin tone may not be reproduced properly.

: Candlelight

- The flash will not fire. However, raising the flash beforehand is recommended, to enable firing of the AF-assist beam ( 126).



: Night Portrait

- Tell subjects to remain still for a moment after the flash fires.
- During Live View shooting, achieving focus may be difficult when the face of the subject looks dark. In this case, set the lens's focus mode switch to <MF> and focus manually.
- When you shoot a night scene with Live View shooting, achieving focus with AF may be difficult if point sources of light are found in the AF point. In this case, set the lens's focus mode switch to <MF> and focus manually.
- The Live View image displayed will not look exactly the same as the actual captured image.

: Handheld Night Scene

- Compared to other shooting modes, the image area will be smaller.
- RAW image quality cannot be set.
- When you shoot a night scene with Live View shooting, achieving focus with AF may be difficult if point sources of light are found in the AF point. In this case, set the lens's focus mode switch to <MF> and focus manually.
- The Live View image displayed will not look exactly the same as the actual captured image.
- If you use a flash and the subject is close, overexposure may result.
- If you use a flash for a night scene with limited lighting, the shots may not align correctly. This may result in a blurry picture.
- If you use a flash with a human subject close to the background that is also illuminated by the flash, the shots may not align correctly. This may result in a blurry picture. Unnatural shadows and unsuitable colors may also appear.
- Flash coverage angle with an external Speedlite:
 - When using a Speedlite with automatic flash coverage setting, the zoom position will be fixed to the wide (wide-angle) end regardless of the lens's zoom position.
 - When using a Speedlite requiring manual flash coverage setting, set the flash head to the normal position.



: **Handheld Night Scene (continued)**

- If you shoot a moving subject, the subject's movement may leave afterimages or the surrounding area of the subject may become dark.
- The image alignment may not function properly with repetitive patterns (lattice, stripes, etc.), flat or single-tone images, or images significantly misaligned due to camera shake.
- It takes some time to record images to the card since they are merged after shooting. During the processing of the images, "buSY" will be displayed in the viewfinder and on the LCD panel, and you cannot take another picture until the processing is complete.

: **HDR Backlight Control**

- Compared to other shooting modes, the image area will be smaller.
- RAW image quality cannot be set.
- Flash photography is not possible.
- Note that the image may not be rendered with a smooth gradation and may look irregular or have significant noise.
- HDR Backlight Control may not be effective for excessively backlit scenes or extremely high-contrast scenes.
- When shooting subjects that are sufficiently bright as they are, for example for normally lit scenes, the image may look unnatural due to the HDR effect.
- If you shoot a moving subject, the subject's movement may leave afterimages or the surrounding area of the subject may become dark.
- The image alignment may not function properly with repetitive patterns (lattice, stripes, etc.), flat or single-tone images, or images significantly misaligned due to camera shake.
- It takes some time to record images to the card since they are merged after shooting. During the processing of the images, "buSY" will be displayed in the viewfinder and on the LCD panel, and you cannot take another picture until the processing is complete.

Shooting with Filter Effects Applied

You can shoot with filter effects applied. In Live View shooting, you can preview filter effects before shooting.



1 Set the Mode dial to <Live View>.



2 Display the Live View image.

- Set the Live View shooting/Movie shooting switch to <Live View>, then press the <START/STOP> button.

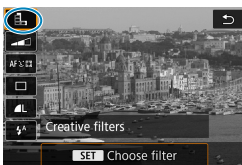

3 Select [Creative filters] on the Quick Control screen.

- Press the <Q> button. (10)
- Use the <▲> <▼> keys to select an icon in the upper left, then press <SET>.

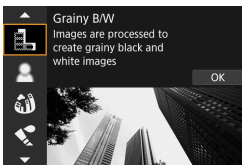

4 Select a filter effect.



- Use the <▲> <▼> keys to select a filter effect (104–106), then press <SET>.
- The image is shown with the filter effect applied.

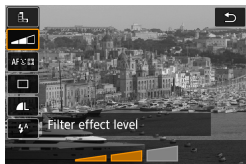

- If you prefer to configure the setting without a Live View preview, press the <Q> button after step 1 and select [Choose filter].



5 Adjust the effect and shoot.

- Press the <Q> button and select an icon below **[Creative filters]** (except , , , , or ).
- Use the <◀> <▶> keys to adjust the effect, then press <SET>.

- RAW and RAW+JPEG are not available. When RAW image quality is set, images are captured with  image quality. When RAW+JPEG image quality is set, images are captured with the specified JPEG image quality.
- Continuous shooting is not available when <[grid]>, <[person]>, <[fish-eye]>, <[magnifying glass]>, <[camera]>, or <[fish-eye]> is set.
- Images shot with the fish-eye effect applied will not have Dust Delete Data (book 241) appended.



In Live View Shooting

- With Grainy B/W, the grainy preview will differ somewhat from the appearance of your shots.
- With Soft focus or Miniature effect options, the soft focus preview may differ somewhat from the appearance of your shots.
- No histogram is displayed.
- A magnified view is not available.
- In Live View shooting in Creative Zone modes, some Creative filter settings are available from the Quick Control screen.

Creative Filter Characteristics

-  **Grainy B/W**

Makes the image grainy and black and white. By adjusting the contrast, you can change the black-and-white effect.

-  **Soft focus**

Gives the image a soft look. By adjusting the blur, you can change the degree of softness.

-  **Fish-eye effect**

Gives the effect of a fish-eye lens. The image will have barrel distortion. Depending on the level of this filter effect, the area trimmed along the periphery of the image changes. Also, because this filter effect magnifies the center of the image, the apparent resolution at the center may degrade depending on the number of recorded pixels, so set the filter effect while checking the resulting image. One AF point is used, fixed at the center.

-  **Water painting effect**

Makes the photo look like a watercolor painting with soft colors. By adjusting the effect, you can change the color density. Note that night scenes or dark scenes may not be rendered with a smooth gradation and may look irregular or have significant noise.

-  **Toy camera effect**

Shifts colors to those typical of toy cameras and darkens the four corners of the image. Color tone options can be used to change the color cast.

-  **Miniature effect**

Creates a diorama effect.

Shooting under the default setting will keep the center looking sharp.

In Live View shooting, you can move the area that looks sharp (the scene frame) as described in “Miniature Effect Operations” (📖 108). 1-point AF is used as the AF method. Shooting with the AF point and scene frame aligned is recommended.

In viewfinder shooting, aim the center AF point shown in the viewfinder on the subject, then shoot.

-  **HDR art standard**

Photos retain more detail in highlights and shadows. With reduced contrast and flatter gradation, the finish resembles a painting. The subject outlines will have bright (or dark) edges.

-  **HDR art vivid**

The colors are more saturated than with **[HDR art standard]**, and the low contrast and flat gradation create a graphic art effect.





-  **HDR art bold**

The colors are the most saturated, making the subject pop out, and the picture looks like an oil painting.

-  **HDR art embossed**

The color saturation, brightness, contrast and gradation are decreased to make the picture look flat. The picture looks faded and old. The subject outlines will have bright (or dark) edges.



- With , , , and , you can shoot high dynamic range photos that retain detail in highlights and shadows of high-contrast scenes. Three consecutive images are captured at different brightnesses each time you shoot and used to create a single image. See the cautions on 📖 107.



< >, < >, < >, and < > Notes

- Compared to other shooting modes, the image area will be smaller.
- Live View previews of the filter effects will not look exactly the same as your shots.
- If you shoot a moving subject, the subject's movement may leave afterimages or the surrounding area of the subject may become dark.
- The image alignment may not function properly with repetitive patterns (lattice, stripes, etc.), flat or single-tone images, or images significantly misaligned due to camera shake.
- Be careful about camera shake in handheld shots.
- The color gradation of the sky or white walls may not be reproduced correctly. Irregular colors, irregular exposure or noise may appear.
- Shooting under fluorescent or LED lighting may result in unnatural color reproduction of the illuminated areas.
- It takes some time to record images to the card since they are merged after shooting. During the processing of the images, "buSY" will be displayed in the viewfinder and on the LCD panel, and you cannot take another picture until the processing is complete.
- Flash photography is not possible. However, raising the flash beforehand is recommended, to enable firing of the AF-assist beam (126).

Miniature Effect Operations

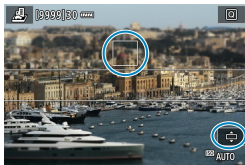

1 Move the AF point.

- Move the AF point to the position to focus on.



2 Move the scene frame and shoot.

- Move the scene frame if the AF point is outside of it, so that the AF point is aligned with it.
- To make the scene frame movable (displayed in orange), press the <Q> button or tap [⏏] in the lower right of the screen. By tapping [⏏], you can also switch between vertical and horizontal scene frame orientation. Switching scene frame orientation is also possible with the <◀> <▶> keys when in horizontal orientation and <▲> <▼> keys when in vertical orientation.
- Use the <▲> <▼> or <◀> <▶> keys to move the scene frame. To center the scene frame again, press the <INFO> button.
- To confirm the position of the scene frame, press <SET>.

Creative Zone

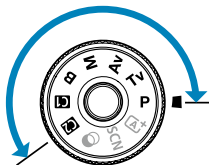

Creative Zone modes give you the freedom to shoot in a variety of ways by setting your preferred shutter speed, aperture value, exposure, and more.

- To clear the shooting mode description displayed when you turn the Mode dial, press <SET> (📖 532).



- Make sure the Multi-function lock feature is off.

Program AE

The camera automatically sets the shutter speed and aperture to suit the subject's brightness.

* <P> stands for Program.

* AE stands for Auto Exposure.



1 Set the Mode dial to <P>.



2 Focus on the subject.

- Aim the AF point over the subject and press the shutter button halfway.



3 Check the display and shoot.

- As long as the exposure value is not blinking, standard exposure will be obtained.

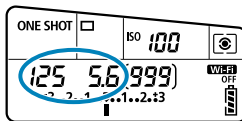

- If the "30'" shutter speed and the lowest f/number blink, it indicates underexposure. Increase the ISO speed or use flash.



- If the "8000" shutter speed and the highest f/number blink, it indicates overexposure. Lower the ISO speed or use an ND filter (sold separately) to reduce the amount of light entering the lens.



Differences Between <P> and <A+> Modes

- In <A+> mode, many functions, such as the AF method and metering mode, are set automatically to prevent spoiled shots. The functions you can set are limited. On the other hand, with <P> mode, only the shutter speed and aperture are set automatically. You can freely set the AF method, metering mode, and other functions.

Program Shift

- To adjust the combination of shutter speed and aperture value while maintaining the same exposure, press the shutter button halfway and turn the <A+> dial. This is called Program shift.
- Program shift will be canceled automatically when the metering timer ends (exposure setting display turns off).
- Program shift cannot be used with flash.

Setting the Shutter Speed Before Shooting (Shutter-Priority AE)

In this mode, you set the shutter speed and the camera automatically sets the aperture to obtain the standard exposure matching the brightness of the subject. A faster shutter speed can freeze the action of a moving subject. A slower shutter speed can create a blurred effect, giving the impression of motion.

* <Tv> stands for Time value.



Blurred motion
(Slow speed: 1/30 sec.)



Frozen motion
(Fast speed: 1/2000 sec.)



1 Set the Mode dial to <Tv>.

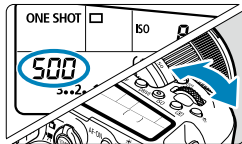

2 Set the desired shutter speed.
● Set with the <  > dial.

3 Focus on the subject.
● Press the shutter button halfway.



4 Check the display and shoot.
● As long as the aperture value is not blinking, the standard exposure will be obtained.



- If the lowest f/number blinks, it indicates underexposure. Use the dial to decrease the shutter speed until the aperture value stops blinking, or set a higher ISO speed.



- If the highest f/number blinks, it indicates overexposure. Use the dial to increase the shutter speed until the aperture value stops blinking, or set a lower ISO speed.



Shutter Speed Display

- The shutter speeds from “8000”* to “4” indicate the denominator of the fractional shutter speed. For example, “125” indicates 1/125 sec. Additionally, “0”5” indicates 0.5 sec. and “15””, 15 sec.

* “16000” when [: Shutter mode] is set to [Electronic] in Live View shooting.

Setting the Aperture Value Before Shooting (Aperture-Priority AE)

In this mode, you set the desired aperture and the camera sets the shutter speed automatically to obtain the standard exposure matching the subject brightness. A higher f/number (smaller aperture hole) will make more of the foreground and background fall within acceptable focus. On the other hand, a lower f/number (larger aperture hole) will make less of the foreground and background fall within acceptable focus.

* <Av> stands for Aperture value (aperture opening).



Blurred background
(With a low aperture
f/number: f/5.6)



Sharp foreground and background
(With a high aperture
f/number: f/32)



1 Set the Mode dial to <Av>.

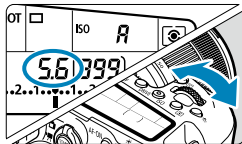

2 Set the desired aperture.
● Set with the <Aperture> dial.

3 Focus on the subject.
● Press the shutter button halfway.



4 Check the display and shoot.
● As long as the shutter speed is not blinking, the standard exposure will be obtained.



- If the "30''" shutter speed blinks, it indicates underexposure. Use the dial to decrease the f/number (open the aperture) until the shutter speed stops blinking, or set a higher ISO speed.



- If the "8000''" shutter speed blinks, it indicates overexposure. Use the dial to increase the f/number (close the aperture) until the shutter speed stops blinking, or set a lower ISO speed.



Aperture Value Display

- The higher the f/number, the smaller the aperture opening will be. The f/number displayed varies depending on the lens. If no lens is attached to the camera, "00" will be displayed for the aperture.

Checking the Area in Focus ☆

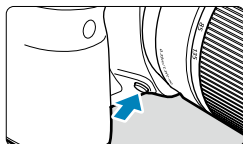

Press the depth-of-field preview button to stop down the lens to the current aperture setting and check the area in focus (depth of field).



- The larger the aperture value, the wider the area (from the foreground to the background) in focus, but the darker the viewfinder display.
- The depth-of-field effect is readily apparent on the Live View image as you change the aperture value and press the depth-of-field preview button (71).
- Exposure is locked (AE lock) as you hold down the depth-of-field preview button.
- Pressing the depth-of-field preview button when a Speedlite 470EX-AI is attached with the <ALB> switch set to <F> (full-auto) starts AI.B full-auto distance measurement.

Setting the Exposure Before Shooting (Manual Exposure)

In this mode, you set both the shutter speed and aperture as desired.

To determine the exposure, refer to the exposure level indicator or use a commercially available exposure meter.

* <M> stands for Manual.



1 Set the Mode dial to <M>.

2 Set the ISO speed (📖 213).

- With ISO Auto, you can set exposure compensation (📖 118).

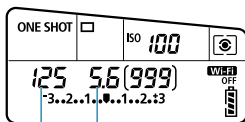

(1) (2)

3 Set the shutter speed and aperture.

- Set the shutter speed with the <🔧> dial and aperture value with the <🕒> dial.

- (1) Shutter speed
- (2) Aperture value



(1) (2)

4 Focus on the subject.

- Press the shutter button halfway.
- Check the exposure level mark <▲> to see how far the current exposure level is from the standard exposure level.

- (1) Standard exposure index
- (2) Exposure level mark



5 Set the exposure and take the picture.

- Check the exposure level indicator and set the desired shutter speed and aperture.
- If the exposure level exceeds ± 3 stops from the standard exposure, the end of the exposure level indicator will display <◀> or <▶>.

Exposure Compensation with ISO Auto

If the ISO speed is set to **[A]** (AUTO) for manual exposure shooting, you can set exposure compensation (📖 160) as follows:

- **[📷: Expo.comp./AEB]**
- **[SET: Expo comp (hold btn, turn 🌞)]** in **[📷.C.Fn III-3: Custom Controls]**
- Quick Control screen



- If ISO Auto is set, the ISO speed setting will change to obtain the standard exposure with the set shutter speed and aperture. Therefore, you may not obtain the desired exposure effect. In this case, set the exposure compensation.



- With the camera set to the **<M>** mode + ISO Auto + **<📷>** (Evaluative metering) and **[📷.C.Fn I-8: AE lock meter. mode after focus]** set to the default setting (📖 558), holding down the shutter button halfway will lock the ISO speed after focus is achieved with One-Shot AF.
- To compare the current exposure to the exposure when you pressed the **<✳>** button initially with an automatically set ISO speed, press the **<✳>** button, recompose the shot, and check the exposure level indicator.
- With ISO Auto set and **[📷.C.Fn I-1: Exposure level increments]** set to **[1/2-stop]**, any 1/2-stop exposure compensation will be implemented with the ISO speed (1/3 stop) and shutter speed. However, the shutter speed displayed will not change.

Long (Bulb) Exposures

In this mode, the shutter stays open as long as you hold down the shutter button completely, and closes when you let go of the shutter button. Use bulb exposures for night scenes, fireworks, the heavens, and other subjects requiring long exposures.



1 Set the Mode dial to .



2 Set the desired aperture.

- Set with the <⚙> or <⌚> dial.

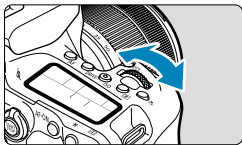

3 Take the picture.

- The exposure will continue for as long as you keep the shutter button pressed completely.
- The elapsed exposure time will be displayed on the LCD panel.



- Do not point the camera toward an intense light source, such as the sun or an intense artificial light source. Doing so may damage the image sensor or the camera's internal components.
- Long bulb exposures produce more noise in the image than usual.
- If ISO Auto is set, ISO 400 will be set (📖614).
- Keep pressing the shutter button completely after you start shooting a bulb exposure with the self-timer, until shooting is finished. No shot will be taken if you release the shutter button during self-timer countdown, although a shutter-release sound will be played.



- With [**📷: Long exp. noise reduction**], you can reduce the noise generated during long exposures (📖 238).
- For bulb exposures, using a tripod and bulb timer is recommended. You can also use mirror lockup (📖 263) in combination.
- You can shoot bulb exposures by using Remote Switch RS-60E3 (sold separately, 📖 156).
- You can also use Remote Controller RC-6 (sold separately, 📖 155) or Wireless Remote Control BR-E1 (sold separately, 📖 156) for bulb exposures. When you press the remote controller's release (transmit) button, the bulb exposure will start immediately or 2 sec. later. Press the button again to stop the bulb exposure.

Bulb Timer ☆

Using the bulb timer eliminates the need to keep holding down the shutter button during exposure.

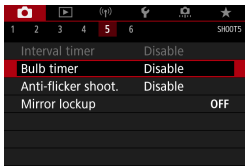

1 Select [**📷: Bulb timer**].

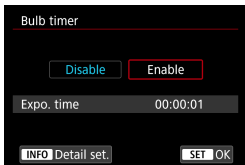

2 Select [**Enable**].

- Select [**Enable**], then press the <INFO> button.

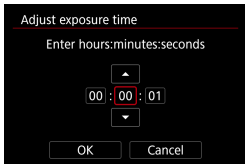

3 Set the desired exposure time.

- Select the hour, minute, or second.
- Press <SET> to display <⬆>.
- Set the desired number, then press <SET>. (Returns to <□>.)

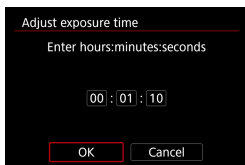

4 Select [OK].

- When you exit the menu, <TIMER> is displayed on the LCD panel.

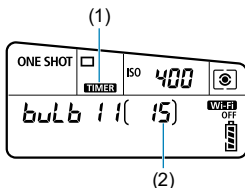

5 Take the picture.

- Press the shutter button completely, and after shooting begins, release it.
- To stop shooting in progress, press the shutter button completely again and release it.
- To cancel the timer setting, set [**Disable**] in step 2.

(1) Bulb timer

(2) Elapsed exposure time



- While the bulb timer is operating, if you press the shutter button completely and let go of it, the bulb exposure will stop.
- If you keep pressing the shutter button completely, the bulb exposure will continue even after the set exposure time elapses.
- The bulb timer is canceled and the setting reverts to [**Disable**] when you set the power switch to <OFF> or change to movie recording or a shooting mode other than .



AF, Drive, and Exposure Settings

This chapter describes how to configure AF, drive mode, metering mode, and related settings.

- A ☆ icon to the right of a page title indicates that the function is available only in Creative Zone.
- In Basic Zone, the AF operation is set automatically.



- <AF> stands for autofocus. <MF> stands for manual focus.

Selecting the AF Operation

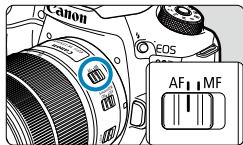

1 Set the lens's focus mode switch to <AF>.

2 Turn the Mode dial to a Creative Zone.

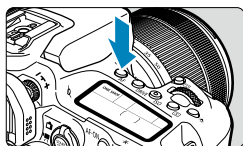

3 Press the <AF> button (ⓘ6).

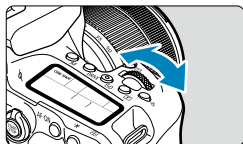

4 Select the AF operation.

- Turn the <ⓘ6> or <ⓘ7> dial.

ONE SHOT: One-Shot AF

AI FOCUS: AI Focus AF

AI SERVO: AI Servo AF

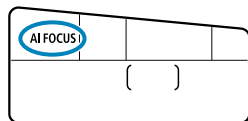

- In Live View shooting, press the <◀> <▶> keys.

ONE SHOT: One-Shot AF

SERVO: Servo AF

One-Shot AF for Still Subjects

This AF operation is suited for still subjects. When you press the shutter button halfway, the camera will focus only once.

- In viewfinder shooting, once the subject is in focus, that AF point is displayed, the focus indicator <●> in the viewfinder lights up, and the camera beeps.
- In Live View shooting, once the subject is in focus, that AF point turns green and the camera beeps.
- The focus remains locked while you hold down the shutter button halfway, allowing you to recompose the image before taking the picture.



- If [**☑**: **Beep**] is set to [**Disable**], the beeper will not sound when focus is achieved.

AI Servo AF (Viewfinder Shooting) or Servo AF (Live View Shooting) for Moving Subjects

This AF operation is suited for moving subjects. While you hold down the shutter button halfway, the camera will keep focusing on the subject continuously.

- In viewfinder shooting, once the subject is in focus, that AF point is displayed.
- In Live View shooting, once the subject is in focus, the AF point turns blue.
- The exposure is set at the moment the picture is taken.



- The beeper will not sound even when focus is achieved.
- The focus indicator <●> in the viewfinder will not light up.

AI Focus AF (Viewfinder Shooting) for Automatic Switching of AF Operation

AI Focus AF switches the AF operation from One-Shot AF to AI Servo AF automatically if a still subject starts moving.

- After the camera uses One-Shot AF to focus on a subject, if it detects subject movement, a change in distance, or similar changes, it switches to AI Servo AF and continues to track the moving subject.



- The camera continues beeping quietly when subjects are in focus using the servo.
- The focus indicator <●> in the viewfinder does not light up when subjects are in focus using the servo.
- Shooting with the focus locked is not possible when the servo is used.
- In <A+> mode in Live View shooting, AI Focus AF is used to focus. Note that Servo AF is used to focus on moving subjects. When focus is achieved, the AF point will turn blue. Note that the camera will not switch to Servo AF if the subject moves during continuous shooting.

AF-Assist Beam

- In viewfinder shooting, the built-in flash can emit an AF-assist beam to make autofocusing easier under low light or in other conditions where autofocusing is difficult. The AF-assist beam will be emitted as needed after you press the <⚡> button to raise the flash and press the shutter button halfway.
- The AF-assist beam is not emitted in Live View shooting, even if the built-in flash is raised.



- The flash does not emit an AF-assist beam when AF operation is set to **[AI Focus AF]** or **[AI Servo AF]**.



- To disable AF-assist beam firing, set **[📷: AF-assist beam firing]** to **[Disable]**.

AF Points Lighting Up in Red (Viewfinder Shooting)

The AF points light up in red when focus is achieved in low-light conditions or on a dark subject. You can disable lighting up in Creative Zone modes ( 569).

Selecting the AF Area and AF Point (Viewfinder Shooting)

Depending on the lens used, the number of usable AF points, AF point patterns, Area AF frame shape, etc. vary. For details, see “Supplemental Information”.

AF Area Selection Mode

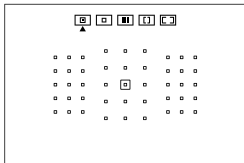

: Spot AF (Manual selection)

- The camera focuses in a narrower area than 1-point AF.
- Effective for pinpoint focusing or focusing on overlapping subjects such as an animal in a cage.
- Because the AF area is narrow, focusing may be difficult in some shooting conditions.

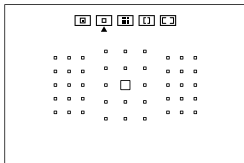

: 1-point AF (Manual selection)

- The camera focuses using a single AF point.

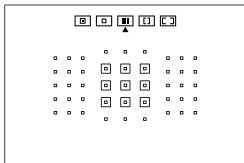

: Zone AF (Manual selection of zone)

- The camera focuses in a zone consisting of nine AF points. Subjects are easier to acquire than with 1-point AF.
- Generally focuses on the nearest subject. Note that any detected faces are given priority in focusing.
- With AI Servo AF, focusing continues as long as subjects can be tracked within the zone.

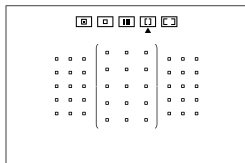

[L]: Large Zone AF (Manual selection of zone)

- The AF area is divided into three focusing zones (left, center, and right) for focusing.
- Subjects are easier to acquire than with Zone AF.
- Generally focuses on the nearest subject. Note that any detected faces are given priority in focusing.
- With AI Servo AF, focusing continues as long as subjects can be tracked within the large zone.

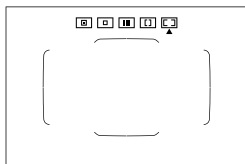



[C]: Automatic selection AF

- The Area AF frame (entire AF area) is used to focus.
- With One-Shot AF, generally focuses on the nearest subject. Note that any detected faces are given priority in focusing.
- With AI Servo AF, you can set the initial position for AI Servo AF (133). As long as the Area AF frame can track the subject during shooting, focusing will continue.



- AF points may not track subjects under some shooting conditions when AI Servo AF is used with Zone AF, Large Zone AF, or Automatic selection AF.
- Focusing may be difficult when using a peripheral AF point or a wide-angle or telephoto lens. In such a case, use the center AF point or an AF point close to the center.
- When the AF point(s) light up, part or all of the viewfinder may light up in red. This is a characteristic of AF point display.
- In low temperatures, the AF point display may be difficult to see or have a slower tracking response due to the characteristics of AF point display device (using liquid crystal).



- With [] **C.Fn II-10: Orientation linked AF point**, you can set the AF area selection mode + AF point or only the AF point separately for the horizontal and vertical orientations ( 565).

Selecting the AF Area Selection Mode

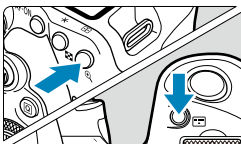

1 Press the **<AF-ON>** or **<AF Area Selection Mode>** button (ⓘ6).

2 Press the **<AF Area Selection Mode>** button.

- Each time you press the **<AF Area Selection Mode>** button, the AF area selection mode changes.



- With [**C.Fn II-7: Select AF area selec. mode**], you can limit the selectable AF area selection modes to only those you want to use (ⓘ563).
- If you set [**C.Fn II-9: AF area selection method**] to [**1: AF Area Selection Mode → Main dial**], you can select the AF area selection mode by pressing the **<AF-ON>** or **<AF Area Selection Mode>** button, then turning the **<Main Dial>** dial (ⓘ564).

Selecting the AF Point or Zone Manually

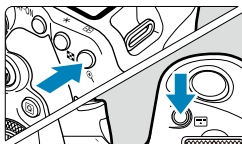

- 1** Press the **<AF-ON>** or **<AF-ON>** button (ⓘ6).

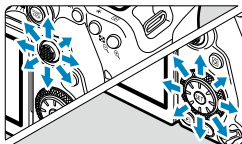

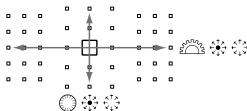
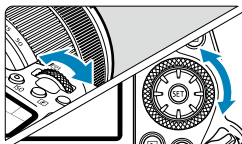

- 2** Select an AF point or zone.
- Use **<AF-ON>**, **<AF-ON>** or the **<AF-ON>** or **<AF-ON>** dial to select an AF point.
 - To select the center AF point or zone, press **<SET>** or **<AF-ON>**.











- When you keep holding down the **<Q>** button and turn the **<AF-ON>** dial, you can select an AF point in vertical direction.
- The following information is shown on the LCD panel.
 - Spot AF and 1-point AF: **SEL []** (Center), **SEL AF** (Off center)
 - Zone AF, Large Zone AF, and Automatic selection AF: **[] AF**

Meaning of Lit or Blinking AF Points

Pressing the <> or <> button lights up the AF points that are cross-type AF points for high-precision autofocusing. The blinking AF points are horizontal-line or vertical-line sensitive. For details, see “Supplemental Information”.

Setting the Initial AI Servo AF Position



When [ C.Fn II-11: Initial Servo AF pt, /☺☺☺] is [1:Initial AF pt set for /☺☺☺] ( 566), you can manually set the initial position for AI Servo AF.

- 1 Set the AF area selection mode to [ Auto selection AF] ( 131).
- 2 Set AF operation to [AI Servo AF] ( 124).
- 3 Set the AF point ( 132).

Shooting Conditions that Make Focusing Difficult

- Subjects with very low contrast
(Example: Blue skies, solid-color flat surfaces, etc.)
- Subjects in very low light
- Strongly backlit or reflective subjects
(Example: Cars with highly reflective bodies, etc.)
- Near and distant subjects positioned close to an AF point
(Example: Animals in cages, etc.)
- Light source such as dots of light positioned close to an AF point
(Example: Night scenes, etc.)
- Subjects with repetitive patterns
(Example: Skyscraper windows, computer keyboards, etc.)
- Subjects with finer patterns than an AF point
(Example: Faces or flowers as small as or smaller than an AF point, etc.)

In such cases, focus in either of the following two ways.

- (1) With One-Shot AF, focus on an object at the same distance as the subject and lock the focus, then recompose the shot ( 125).
- (2) Set the lens's focus mode switch to **<MF>** and focus manually ( 147).



- Depending on the subject, focus may be achieved by slightly recomposing the shot and performing AF operation again.

Selecting the AF Method (Live View Shooting)

AF Method

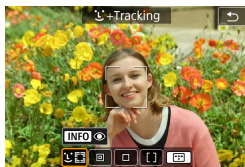

: **Face+Tracking**

The camera detects and focuses on people's faces. <[]> (an AF point) appears over any face detected, which is then tracked.

If no face is detected, the entire AF area is used for auto selection AF. With Servo AF, you can set the initial position for AF (143). As long as the Area AF frame can track the subject during shooting, focusing will continue.

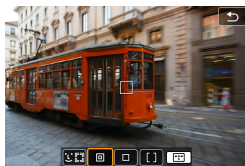

: **Spot AF**

The camera focuses in a narrower area than 1-point AF.

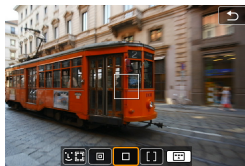

: **1-point AF**

The camera focuses using a single AF point <[]>.

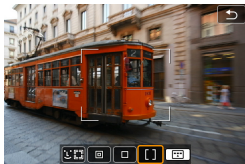

[]: **Zone AF**

Uses auto selection AF in Zone AF frames to cover a large area, which makes focusing easier than with 1-point AF.

Prioritizes focusing on the nearest subject. Faces of any people in the Zone AF frame are also given priority in focusing. AF points in focus are displayed with <□>.

Selecting the AF Method

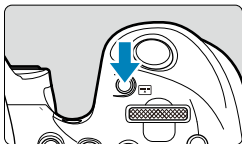

1 Press the $\langle \text{AF} \rangle$ button.

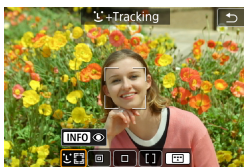

2 Select the AF method.

- Each time you press the $\langle \text{AF} \rangle$ button, the AF method changes.

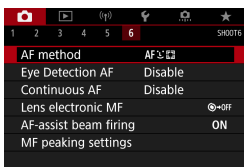



- You can also make your selection from $\langle \text{AF} \rangle$ [AF method].



- In $\langle \text{AF} \rangle$ mode, $\langle \text{AF} \rangle$ is set automatically.
- In $\langle \text{AF} \rangle$ mode, only **[1-point AF]** or **[Zone AF]** can be set.
- The descriptions on 138–141 assume that the AF operation is set to **[One-Shot AF]** (125). With **[Servo AF]** (125) set, the AF point will turn blue when focus is achieved.
- Regarding the Touch Shutter (AF and shutter release by touch operation), see 72.
- With $\langle \text{AF} \rangle$ **[C.Fn II-9: AF area selection method]** set to **[1: AF → Main dial]**, you can select the AF method by pressing the $\langle \text{AF} \rangle$ button and then turning the $\langle \text{Dial} \rangle$.





● **(face)+Tracking:** 

The camera detects and focuses on human faces. If a face moves, the AF point  also moves to track the face.

You can set **[Eye Detection AF]** to **[Enable]** to shoot with the subject's eyes in focus ( 142).



1 Check the AF point.

-  (an AF point) appears over any face detected.
- You can choose a face to focus on with the   keys when  appears.
- Press  to move the AF point to the face of the person in the center.

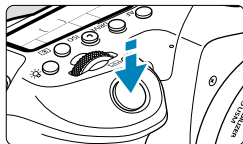



2 Focus and take the picture.

- Once you press the shutter button halfway and the subject is in focus, the AF point turns green and the camera beeps.
- An orange AF point indicates that the camera could not focus on subjects.



Tapping a Face for Focus

Tapping a face or subject to focus on changes the AF point to  and focuses where you tap.

Even if the face or subject moves on the screen, the AF point  moves to track it.



- If the subject's face is significantly out of focus, face detection will not be possible. Adjust the focus manually ( 147) so that the face can be detected, then perform AF.
- An object other than a human face may be detected as a face.
- Face detection will not work if the face is very small or large in the picture, too bright or too dark, or partially hidden.
- AF cannot detect subjects or people's faces at the edges of the screen. Recompose the shot to center the subject or bring the subject closer to the center.



- The  may cover only a part of the face, not the whole face.
- The size of the AF point changes depending on the subject.

● Spot AF / 1-point AF / Zone AF

You can manually set the AF point or Zone AF frame. Here, 1-point AF screens are used as an example.



(1)

1 Check the AF point.

- The AF point (1) will appear. With Zone AF, the Zone AF frame is displayed.



2 Move the AF point.

- Use <⬅️> <➡️> to move the AF point to where you want to focus (but note that with some lenses, it may not move to the edge of the screen).
- You can also tap the screen to move the AF point.
- To center the AF point or Zone AF frame, press <⬅️> or the <ⓈET> or <🗑️> button.

Eye Detection AF

With the AF method set to [**Tracking**], you can shoot with the subject's eyes in focus.

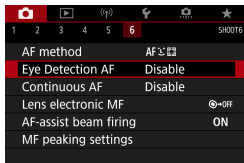

1 Select [**Eye Detection AF**].

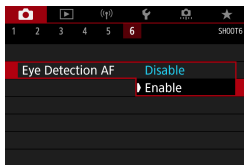

2 Select [**Enable**].



3 Aim the camera at the subject.

- An AF point is displayed around their eye.
- You can tap the screen to select an eye for focus.
The entire face is selected when you tap other facial features, such as their nose or mouth. Eyes to focus on are selected automatically.
- Depending on the [**Eye Detection AF**] setting, you can choose an eye for focus with the <◀> <▶> keys when <⏏> appears.

4 Take the picture.



- Subject eyes may not be detected correctly, depending on the subject and shooting conditions.



- To disable Eye Detection AF without using menu operations, press these buttons, one after another: <[AF-ON]>, and <[INFO]>. To resume Eye Detection AF, press the <[INFO]> button again.

Setting the Initial Servo AF Position

You can freely set the initial position for Servo AF when [**C.Fn II-11: Initial Servo AF pt**, ()/] is [1:Initial AF pt set for ()/] (book 566).

1 Set the AF method to [+Tracking] (book 137).

2 Set the AF operation to [Servo AF] (book 124).

3 Set the AF point (book 132).

- Use <[AF-ON]> <[AF-ON]> or tap the screen to move the AF point (1), then set it.
- Pressing <[AF-ON]> or the <[SET]> or <[DELETE]> button will return the AF point to the screen center.

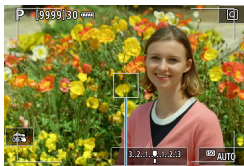

(1)

Magnified View

To check the focus when the AF method is other than [**⬇**+Tracking], magnify display by approx. 5× or 10× by pressing the <Q> button (or tapping <Q>).

- Magnification is centered on the AF point for [**Spot AF**] or [**1-point AF**] and on the Zone AF frame for [**Zone AF**].
- Autofocusing is performed with magnified display if you press the shutter button halfway when set to [**1-point AF**], and [**Spot AF**]. When set to other AF methods, autofocusing is performed after restoring normal display.
- With Servo AF, if you press the shutter button halfway in the magnified view, the camera will return to the normal view for focusing.



- If focusing is difficult in the magnified view, return to the normal view and perform AF.
- If you perform AF in the normal view and then use the magnified view, accurate focus may not be achieved.
- AF speed differs between the normal view and magnified view.
- Continuous AF is not available when display is magnified.
- With the magnified view, achieving focus becomes more difficult due to camera shake. Using a tripod is recommended.

AF Shooting Tips

- Even when focus is achieved, pressing the shutter button halfway will focus again.
- Image brightness may change during autofocus.
- Depending on the subject and shooting conditions, it may take longer to focus, or the continuous shooting speed may decrease.
- If the light source changes as you shoot, the screen may flicker, and focusing may be difficult. In this case, restart the camera and resume shooting with AF under the light source you will use.
- If focusing is not possible with AF, focus manually ( 147).
- For subjects at the edge of the screen that are slightly out of focus, try centering the subject (or AF point, or Zone AF frame) to bring them into focus, then recompose the shot before shooting.
- With certain lenses, it may take more time to achieve focus with autofocus, or accurate focusing may not be achieved.

Shooting Conditions that Make Focusing Difficult

- Subject with low-contrast such as the blue sky, solid-color flat surfaces or when highlight or shadow details are clipped.
- Subjects in low light.
- Stripes and other patterns where there is contrast only in the horizontal direction.
- Subjects with repetitive patterns (Example: Skyscraper windows, computer keyboards, etc.).
- Fine lines and subject outlines.
- Under a light source whose brightness, color, or pattern keeps changing.
- Night scenes or points of light.
- The image flickers under fluorescent or LED lighting.
- Extremely small subjects.
- Subjects at the edge of the screen.
- Strongly backlit or reflective subjects (Example: Car with a highly reflective body, etc.).
- Near and distant subjects covered by an AF point (Example: Animal in a cage, etc.).
- Subjects that keep moving within the AF point and will not stay still due to camera shake or subject blur.
- Performing AF when the subject is very far out of focus.
- Soft focus effect is applied with a soft focus lens.
- A special effect filter is used.
- Noise (dots of light, banding, etc.) appears on the screen during AF.

AF Range

The available autofocus range varies depending on the lens and aspect ratio used and whether you are recording using features such as 4K movie cropping or Movie digital IS.

Manual Focus

If focus cannot be achieved with autofocus, follow the procedure below to focus manually.

In Viewfinder Shooting

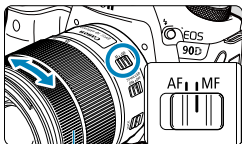

(1)

1 Set the lens's focus mode switch to <MF>.

2 Focus on the subject.

- Turn the lens focusing ring (1) until the subject looks sharp in the viewfinder.

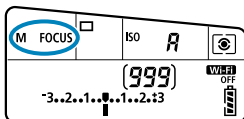

- If you press the shutter button halfway during manual focusing, the AF point that achieved focus will be displayed, and the focus indicator <●> will light up in the viewfinder.
- With Automatic selection AF, when the center AF point achieves focus, the focus indicator <●> will light up.

In Live View Shooting

You can magnify the image when focusing.

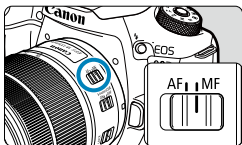

1 Set the lens's focus mode switch to <MF>.

- Turn the lens focusing ring to focus roughly.

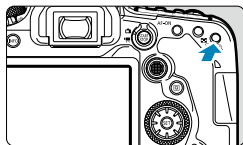

2 Magnify the image.

- Press the $\langle \text{Q} \rangle$ button to activate magnified display.



3 Determine an area to magnify.

- Use $\langle \text{M} \rangle$ $\langle \text{M} \rangle$ to move the magnified area into position for focusing.
- To center the magnified area, press $\langle \text{M} \rangle$ or the $\langle \text{SET} \rangle$ or $\langle \text{M} \rangle$ button.
- Each press of the $\langle \text{Q} \rangle$ button changes the magnification ratio, as follows.

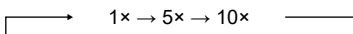

4 Focus on the subject.

- While looking at the magnified image, turn the lens focusing ring to focus.
- After achieving focus, press the $\langle \text{Q} \rangle$ button to return to the normal view.

- In magnified view, the exposure is locked.
- You can use the Touch Shutter to take a picture during normal display.

Setting MF Peaking (Outline Emphasis)

In Live View shooting, edges of subjects in focus can be displayed in color to make focusing easier. You can set the outline color and adjust the sensitivity (level) of edge detection (except in $[A^+]$ mode).

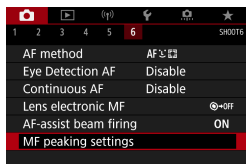

1 Select [**MF peaking settings**].

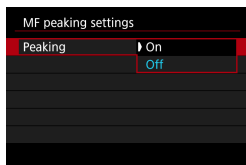

2 Select [**Peaking**].

- Select [**On**].

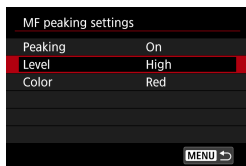

3 Set the level and color.

- Set it as necessary.



- Peaking display is not shown during magnified display.
- MF peaking may be hard to discern at high ISO speeds, especially when ISO expansion is set. If necessary, lower the ISO speed or set [**Peaking**] to [**Off**].



- Peaking display shown on the screen is not recorded in images.

Selecting the Drive Mode

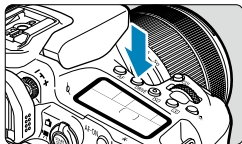

1 Press the <DRIVE> button (⚙️).

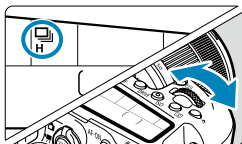

2 Select the drive mode.

- Turn the <⚙️> dial.

• : **Single shooting**

When you press the shutter button completely, only one shot will be taken.

• : **High-speed continuous shooting**

When you hold down the shutter button completely, you can shoot continuously at max. approx. 10 shots/sec. in viewfinder shooting or 11 shots/sec. in Live View shooting while you keep holding it down. When the AF operation is set to **[Servo AF]** in Live View shooting, the continuous shooting speed will be max. approx. 7.0 shots/sec.

- : **Low-speed continuous shooting/Continuous shooting**

When you hold down the shutter button completely, you can shoot continuously at **max. approx. 3.0 shots/sec.** while you keep holding it down. (In <  > mode, at max. approx. 5.7 shots/sec. in viewfinder shooting, and at max. approx. 4.3 shots/sec. in Live View shooting.)

- S: **Silent single shooting**

You can perform single shooting with quieter mechanical sounds during viewfinder shooting. This cannot be set for Live View shooting.



- S: **Silent continuous shooting**

You can shoot continuously (**at max. approx. 3.0 shots/sec.**) with quieter mechanical sounds during viewfinder shooting. This cannot be set for Live View shooting.

- : **Self-timer: 10 sec./remote control**

- 2: **Self-timer: 2 sec./remote control**

- C: **Self-timer: Continuous shooting**

For self-timer shooting, see  153. For remote control shooting, see  155.



- Approx. 10 shots/sec. is the maximum high-speed continuous shooting speed (150) under these conditions: shooting with a fully charged Battery Pack LP-E6N at a 1/1000 sec. or faster shutter speed and maximum aperture (depending on the lens), Image Stabilizer off (depending on the lens), at room temperature (+23°C / 73°F), with flicker reduction disabled.
- The continuous shooting speed for may decrease depending on factors such as temperature, battery level, flicker reduction, shutter speed, aperture value, subject conditions, brightness, AF operation, lens, live view shooting, built-in flash use, and shooting function settings.
- With [: **Anti-flicker shoot.**] set to [**Enable**] (261), shooting under flickering light may decrease the maximum continuous shooting speed. Also, the continuous shooting interval may become irregular and the release time lag may become longer.
- With AI Servo AF/Servo AF, the maximum continuous shooting speed may become slower depending on the subject conditions and the lens used.
- The high-speed continuous shooting speed may be lower when using Battery Grip BG-E14 (sold separately) with AA/R6 batteries.
- If the battery temperature is low due to a low ambient temperature, the maximum continuous shooting speed may decrease.
- If or is set, the time lag from when you press the shutter button completely until the shutter is released may be longer than normal.
- When internal memory becomes full during continuous shooting, the continuous shooting speed may drop off because shooting will be temporarily disabled (201).

Using the Self-Timer

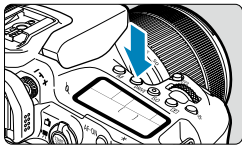

- 1** Press the <DRIVE> button (ⓘ6).

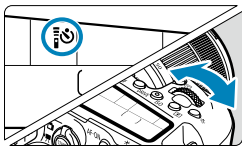

- 2** Select the self-timer.

- Turn the <ⓘ6> dial.

ⓘ6: Shoot in 10 sec.

Remote control shooting is also possible (📖 155).

ⓘ2: Shoot in 2 sec.

Remote control shooting is also possible (📖 155).

ⓘC: Shoot continuously in 10 sec. for the specified number of shots

Use the <ⓘ6> dial to set the number of shots to take (2–10). Remote control shooting is not possible.

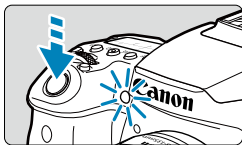

- 3** Take the picture.

- Focus on the subject, then press the shutter button completely.
- You can check the self-timer operation with the self-timer lamp, beeper, and countdown display (in seconds) on the LCD panel.



- With $\langle \text{Ⓢ}_C \rangle$, the shooting interval may become longer under some shooting conditions, depending on image quality, use of flash, and other factors.
- If you will not look through the viewfinder when pressing the shutter button, attach the eyepiece cover (📖 157). Light that enters the viewfinder may prevent suitable exposure.



- $\langle \text{Ⓢ}_2 \rangle$ enables you to shoot without touching the camera mounted on a tripod. This prevents camera shake if you shoot still-life or long exposures.
- After taking self-timer shots, playing back the image (📖 332) to check focus and exposure is recommended.
- When using the self-timer to shoot yourself, use focus lock (📖 80) on an object at the same distance as where you will stand.
- To cancel the self-timer after it starts, either tap the screen or press the $\langle \text{Ⓢ} \rangle$ or $\langle \text{DRIVE} \rangle$ button.
- If remote control shooting is enabled, the auto power off will take effect in approx. 2 min. even if [⚡ : **Auto power off**] is set to 1 min. or slower.
- If [📷 : **Bulb timer**] is set to [**Enable**], $\langle \text{Ⓢ}_C \rangle$ (**[Self-timer:Continuous]**) cannot be selected.

Remote Control Shooting

For remote control shooting, you can use Remote Controller RC-6, Wireless Remote Control BR-E1, or Remote Switch RS-60E3 (infrared, Bluetooth, and wired connections, respectively; sold separately).

Remote Controller RC-6

You can shoot remotely up to approx. 5 meters/16.4 feet away from the front of the camera. You can either shoot immediately or with a 2-sec. delay.

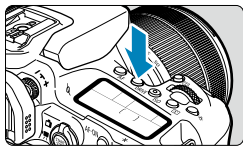

- 1 Press the <DRIVE> button (ⓘ6).

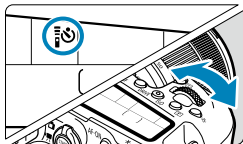

- 2 Select the self-timer/remote control.

- Turn the <mode> dial to select <self-timer> or <remote control>.

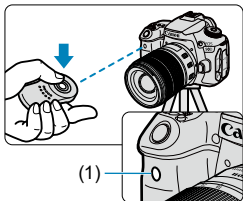

- 3 Press the remote controller's release (transmit) button.

- Point the remote controller toward the camera's remote control sensor (1), then press the release (transmit) button.
- Autofocusing is performed when the focus mode switch is set to <AF>.
- The remote control lamp lights up and the picture is taken.

- Infrared remote controllers such as the RC-6 cannot be used for remote control shooting when the camera is paired via Bluetooth with a smartphone or wireless remote control.
- Fluorescent or LED lighting may cause camera misoperation by triggering the shutter inadvertently. Try to keep the camera away from such light sources.
- If you point a remote controller for a TV set toward the camera and operate it, it may cause camera misoperation by triggering the shutter inadvertently.
- If flash light is emitted from a flash on another camera around this camera, it may cause camera malfunction by triggering the shutter inadvertently. Do not expose the remote control sensor to flash light from a flash on another camera.

Wireless Remote Control BR-E1

You can shoot remotely up to approx. 5 meters/16.4 feet away from the camera.

After pairing the camera and BR-E1 (📖 464), set the drive mode to <📷📷> or <📷📷2> (📖 151).

For operation procedures, refer to the BR-E1 instruction manual.

RC-6 and BR-E1

- If remote control shooting is enabled, the auto power off will take effect in approx. 2 min.
- RC-6 or BR-E1 can also be used for movie recording (📖 322).

Remote Switch RS-60E3

Once connected to the camera, the switch enables you to shoot remotely over a wired connection.

For operation procedures, refer to the RS-60E3 instruction manual.

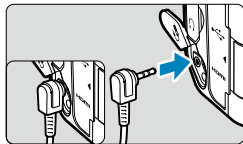

- 1 Open the terminal cover.
- 2 Connect the plug to the remote control terminal.

Eyepiece Cover

Shots taken without looking through the viewfinder (as when using the self-timer or a remote control) may be underexposed. To prevent this, use the eyepiece cover (📖 41) attached to the camera strap.

Note that attaching the eyepiece cover is not necessary in Live View shooting or movie recording.

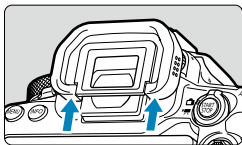

1 Detach the eyecup.

- Push the bottom of the eyecup to detach it.

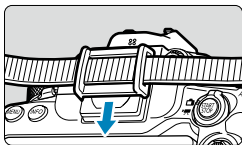

2 Attach the eyepiece cover.

- Slide the eyepiece cover down into the eyepiece groove to attach it.
- After you finish shooting, detach the eyepiece cover and attach the eyecup.

Selecting the Metering Mode



You can select how the camera determines subject brightness. In Basic Zone, evaluative metering is set automatically. (In the <SCN: []> or <[]: []> mode, center-weighted average metering is set automatically.)

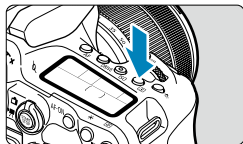

1 Press the <[]> button (10).

- You can also press the <[]> button and configure this setting from the Quick Control screen.

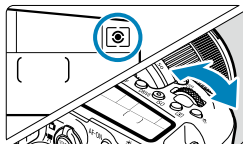

2 Select the metering mode.

- Turn the <[]> or <[]> dial.

• [] Evaluative metering

General-purpose metering mode suited even for backlit subjects. The camera adjusts the exposure automatically to suit the scene.

• [] Partial metering

Effective where there are much brighter lights around the subject due to backlight, etc. Covers approx. 6.5% of the area at the center of the screen in viewfinder shooting or 4.5% in Live View shooting.

• [] Spot metering

Effective when metering a specific part of the subject or scene. Covers approx. 2.0% of the area at the center of the screen in viewfinder shooting or 2.6% in Live View shooting. The spot metering circle will be displayed in the viewfinder.

• [] Center-weighted average metering

The metering across the screen is averaged, with the center of the screen weighted more heavily.



- By default, the camera will set the exposure as follows.
With <[AE-L/AF-ON]>, holding down the shutter button halfway will lock the exposure setting (AE lock) after focus is achieved with One-Shot AF. In the <[AE-L/AF-ON]>, <[AE-L/AF-ON]>, and <[AE-L/AF-ON]> modes, the exposure is set at the moment the picture is taken. (Pressing the shutter button halfway does not lock the exposure.)
- With [**C.Fn I-8: AE lock meter. mode after focus**], you can set whether or not to lock the exposure (AE lock) when focus is achieved with One-Shot AF (📖 558).

Exposure Compensation



Exposure compensation can brighten (increased exposure) or darken (decreased exposure) the standard exposure set by the camera.

Exposure compensation can be set in the <P>, <Tv>, <Av>, and <M> shooting modes.

For details on exposure compensation when <M> mode and ISO Auto are both set, see 118.

Increased exposure for a brighter image



Decreased exposure for a darker image



1 Check the exposure.

- Press the shutter button halfway and check the exposure level indicator.

2 Set the compensation amount.

- Set with the dial.
- The exposure compensation range is ± 5 stops in viewfinder shooting and ± 3 stops in Live View shooting.
- As shown in the viewfinder and on the LCD panel, the exposure compensation range is ± 3 stops. To set exposure compensation beyond ± 3 stops, use the Quick Control (71) screen or follow the instructions for [: Expo.comp./AEB] (211).

3 Take the picture.

- To cancel exposure compensation, return the exposure level indicator <|> to <|>, the standard exposure index.

- If [: Auto Lighting Optimizer] (218) is set to any setting other than [Disable], the image may still look bright even if a decreased exposure compensation for a darker image is set.

- The exposure compensation amount will remain in effect even after you set the power switch to <OFF>.
- If the exposure compensation amount exceeds ± 3 stops, the end of the exposure level indicator will display <|> or <|>.

Locking the Exposure (AE Lock)



You can lock the exposure when you want to set the focus and exposure separately or when you are to take multiple shots at the same exposure setting. Press the <∗> button to lock the exposure, then recompose and take the picture. It is effective for shooting backlit subjects, etc.

1 Focus on the subject.

- Press the shutter button halfway.

2 Press the <∗> button (∅4).

- A <∗> icon is displayed in the viewfinder or on the screen, indicating that the exposure is locked (AE lock).
- Each time you press the <∗> button, the current exposure setting is locked.

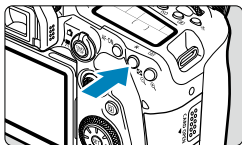

3 Recompose and take the picture.

- When you are to take more pictures while maintaining the AE lock, keep holding down the <∗> button and press the shutter button to take another picture.

AE Lock Effects

Metering Mode (158)	AF Point Selection Method (131, 132)	
	Automatic Selection	Manual Selection
	Exposure centered on the AF point in focus is locked.	Exposure centered on the selected AF point is locked.
	AE lock is applied at the center AF point.	

* When the <∅> is set and the lens's focus mode switch is set to <MF>, AE lock is applied with the exposure weighted on the center AF point.



- AE lock is not possible with bulb exposures.



Flash Photography

This chapter describes how to shoot with the built-in flash or an external flash (EL/EX Speedlites).



- Flash cannot be used while you are recording movies.
- AEB is not available in flash photography.

Shooting With the Built-in Flash

Using the built-in flash is recommended when the <⚡> icon appears in the viewfinder or on the screen, when subjects in daytime shots are backlit, or when shooting under low light.

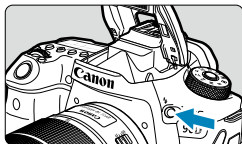

1 Press the <⚡> button.

2 Press the shutter button halfway.

- Confirm that a <⚡> icon appears in the viewfinder or on the screen.

3 Take the picture.

- The built-in flash fires according to **[Flash firing]** settings (📖 169).
- To retract the built-in flash after shooting, push it down with your fingers until it clicks into place.

Approximate Built-in Flash Range

(approx. range in meters / feet)

ISO Speed (📖 213)	EF-S18-135mm f/3.5-5.6 IS USM	
	Wide-angle End	Telephoto End
	f/3.5	f/5.6
100	1–3.4 / 3.3–11.2	1–2.1 / 3.3–6.9
400	1–6.9 / 3.3–22.6	1–4.3 / 3.3–14.1
1600	1.7–13.7 / 5.6–44.9	1.1–8.6 / 3.6–28.2
6400	3.4–27.4 / 11.2–89.9	2.1–17.1 / 6.9–56.1

* It may not be possible to obtain standard exposure when shooting distant subjects at high ISO speeds, or under certain subject conditions.

Shutter Speed and Aperture Value in Flash Photography

Shooting Mode	Shutter Speed	Aperture Value
P	Auto (1/250–1/30 sec.)*	Automatically set
Tv	Manual (1/250–30 sec.)	Automatically set
Av	Auto (1/250–30 sec.)*	Manually set
M	Manual (1/250–30 sec.)	Manually set
B	Exposure continues as long as you hold down the shutter button, or until the bulb timer elapses.	Manually set

* When **[Slow synchro]** under **[Flash control]** is set to **[1/250-30sec. auto]**.



- Do not use the built-in flash unless it is fully raised.
- The bottom of images may be dark if light from the built-in flash is obstructed by a lens hood, or by a subject that is too close.



- If the bottom of images is dark when you use super telephoto or large-diameter lenses, consider using an external Speedlite (sold separately, [p. 179](#)).

Flash Photography in <Av> Mode

Flash output is automatically adjusted to provide suitable flash exposure for your specified aperture value.

In low light, the main subject is exposed with autoflash metering and the background with a slow shutter speed, to provide standard exposure for both the subject and background. Using a tripod is recommended.

Flash Exposure Compensation ☆

Just as exposure compensation is adjustable, you can also adjust flash output of the built-in flash.

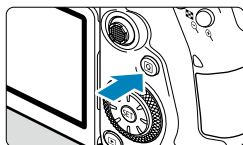

1 Press the <Q> button.

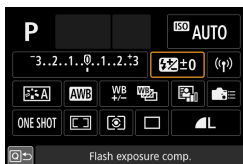

2 Select [].

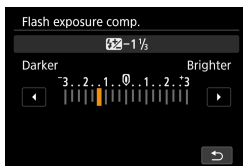

3 Set the compensation amount.

- To make flash exposure brighter, set the compensation amount toward **[Brighter]** (positive compensation), or to make it darker, set it toward **[Darker]** (negative compensation).
- After you are finished shooting, follow steps 1–3 to return the compensation amount to zero.

● When [: Auto Lighting Optimizer] (218) is set to any setting other than **[Disable]**, images may still look bright even if negative compensation is set.

- The exposure compensation amount will remain in effect even after you set the power switch to <OFF>.
- You can also set flash exposure compensation with **[Built-in flash settings]** in [: Flash control] (168).
- The camera can also be used to set the external Speedlite's flash exposure compensation in the same way as with the built-in flash.

✳ Shooting With FE Lock ☆

Viewfinder shooting with FE (flash exposure) Lock provides suitable flash exposure over your specified area of the subject.

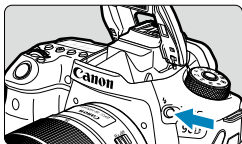

1 Press the <⚡> button.

2 Press the shutter button halfway.

- Press the shutter button halfway and confirm that a <⚡> icon appears in the viewfinder or on the screen.

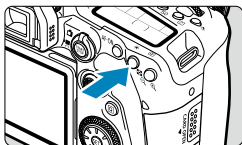

3 Press the <✳> button (Ⓜ16).

- Center the subject in the viewfinder or on the screen, then press the <✳> button.

A preflash is fired by the flash, and the required flash output level is retained.

[FEL] appears briefly in the viewfinder or on the screen, and <⚡✳> lights up.

- Each time you press the <✳> button, a preflash is fired, and the flash output required for shooting is retained.



4 Take the picture.

- Compose the shot and press the shutter button completely.



- The <⚡> icon blinks when subjects are too far away and your shots would be dark. Approach the subject and repeat steps 2–4.

Flash Function Settings

Functions of the built-in flash or external EL/EX series Speedlites can be set from menu screens on the camera.

Before setting functions of external Speedlites, attach the Speedlite and turn it on.

For details on external Speedlite functions, refer to the Speedlite's instruction manual.

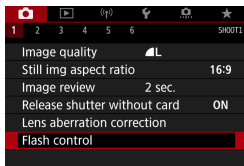

1 Select [: Flash control].

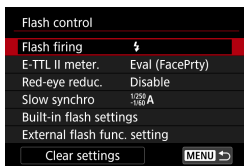

2 Select an item.

Flash Firing

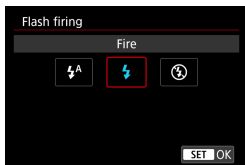

Set to [**⚡^A**] (in Basic Zone or <P> modes) to have the flash fire automatically, based on shooting conditions.

Set to [**⚡**] to have the flash always fire when you shoot.

Select [**⚡/**] (in Creative Zone modes) to keep the flash off, or if you will use the AF-assist beam.

E-TTL II Flash Metering ☆

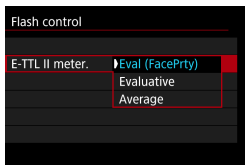

Set to [**Eval (FacePrty)**] for flash metering suitable for shots of people.

Continuous shooting speed for [**☑H**] will become slower than when [**Evaluative**] or [**Average**] is selected.

Set to [**Evaluative**] for flash metering that emphasizes firing in continuous shooting. If [**Average**] is set, the flash exposure will be averaged for the entire metered scene.



- Even with setting [**Eval (FacePrty)**], the expected result may not be obtained depending on the shooting conditions and subject.

Red-eye Reduction

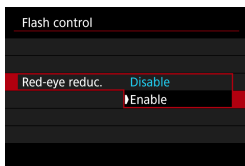

Set to [**Enable**] to reduce red-eye by emitting the red-eye reduction lamp before firing the flash.

Slow Synchro ☆

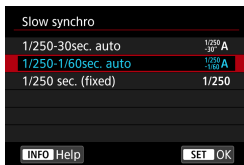

You can set the flash-sync speed for flash photography in <Av> aperture-priority AE mode or <P> Program AE mode.

- **[^{1/250}/₋₃₀ A] 1/250-30sec. auto**

The flash sync speed is set automatically within a range of 1/250 sec. to 30 sec. to suit the scene's brightness. Slow-sync shooting is used under some shooting conditions, in low-light locations, and shutter speed is automatically lowered.

- **[^{1/250}/_{-1/60} A] 1/250-1/60sec. auto**

Prevents a slow shutter speed from being set automatically in low-light conditions. It is effective for preventing subject blur and camera shake. However, while the subject will be properly exposed with the flash, the background may come out dark.

- **[1/250] 1/250 sec. (fixed)**

The flash sync speed is fixed at 1/250 sec. This more effectively prevents subject blur and camera shake than with **[1/250-1/60sec. auto]**. However, in low light, the subject's background will come out darker than with **[1/250-1/60sec. auto]**.



- To use slow-sync shooting in <Av> or <P> mode, set to **[1/250-30sec. auto]**.

Built-in Flash Function Settings ☆

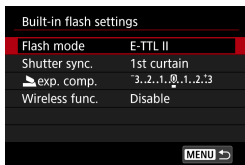

● Flash mode

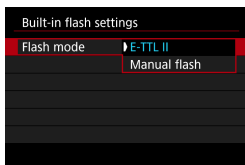

Set to **[E-TTL II]** to shoot in E-TTL II/E-TTL fully automatic flash mode.

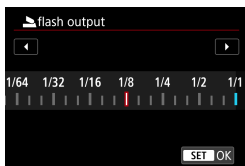

Set to **[Manual flash]** to specify your preferred flash output manually.

● Shutter synchronization

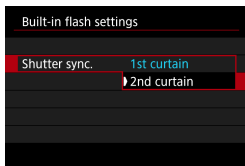

Normally, set this to **[1st curtain]** so that the flash fires immediately after the exposure starts.

Set to **[2nd curtain]** and use low shutter speeds for natural-looking shots of subject motion trails, such as car headlights.



- When using second-curtain synchronization, set the shutter speed to 1/80 sec. or slower. If the shutter speed is faster than 1/80 sec., first-curtain synchronization will be applied automatically even if **[2nd curtain]** is set.

● Flash exposure compensation

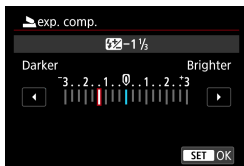

Just as exposure compensation is adjustable, you can also adjust flash output of the built-in flash (📖 166).

● Wireless functions

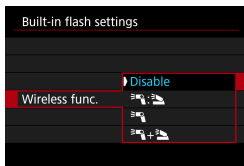

You can use another Canon Speedlite compatible with optical wireless flash photography to shoot with wireless multiple-flash lighting (📖 180).

External Flash Function Settings ☆

The information displayed, position of display, and available options vary depending on the Speedlite model, its Custom Function settings, the flash mode, and other factors. Refer to the instruction manual of your flash unit for details on its functions.

Sample display

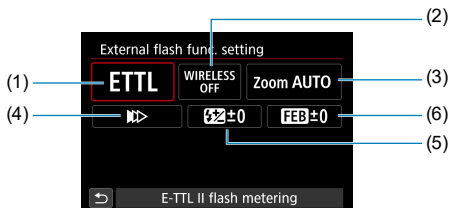

(1) Flash mode

(2) Wireless functions / Firing ratio control

(3) Flash zoom (Flash coverage)

(4) Shutter synchronization

(5) Flash exposure compensation

(6) Flash exposure bracketing



- Functions are limited when using EX series Speedlites that are not compatible with flash function settings.

● Flash mode

You can select the flash mode to suit your desired flash photography.

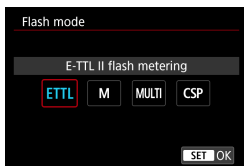

[E-TTL II] is the standard mode of EL/EX series Speedlites for automatic flash photography.

[Manual flash] is for setting the Speedlite's **[Flash output]** yourself.

[CSP] (continuous shooting priority mode) is available when using a compatible external Speedlite. This mode automatically reduces flash output by one stop and increases ISO speed by one stop. Useful in continuous shooting, and helps conserve flash battery power.

Regarding other flash modes, refer to the Instruction Manual of a Speedlite compatible with the respective flash mode.

- Adjust exposure compensation (📖 160) as needed in case of overexposure from flash photography with **[CSP]** in <Tv> or <M> mode.

- With **[CSP]**, ISO speed is automatically set to **[Auto]**.

● Wireless functions

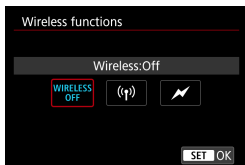

You can use radio or optical wireless transmission to shoot with wireless multiple-flash lighting.

For details on wireless flash, refer to the Instruction Manual of a Speedlite compatible with wireless flash photography.

● Firing ratio control

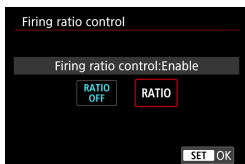

With a macro flash, you can set the firing ratio control.

For details on firing ratio control, refer to the macro flash's Instruction Manual.

● Flash zoom (Flash coverage)

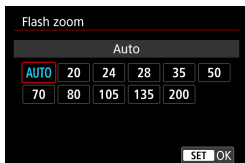

With Speedlites having a zooming flash head, you can set the flash coverage.

● Shutter synchronization

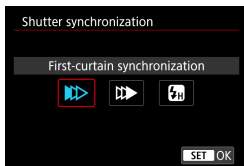

Normally, set this to **[First-curtain synchronization]** so that the flash fires immediately after the exposure starts.

Set to **[Second-curtain synchronization]** and use low shutter speeds for natural-looking shots of subject motion trails, such as car headlights.

Set to **[High-speed synchronization]** for flash photography at higher shutter speeds than the maximum flash sync shutter speed. This is effective when shooting with an open aperture in **<Av>** mode to blur the background behind subjects outdoors in daylight, for example.

- ⚠ When using second-curtain synchronization, set the shutter speed to 1/80 sec. or slower. If the shutter speed is faster than 1/80 sec., first-curtain synchronization will be applied automatically even if **[Second-curtain synchronization]** is set.

● Flash exposure compensation

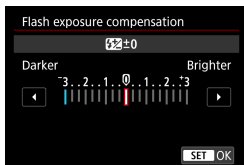

Just as exposure compensation is adjustable, you can also adjust flash output of external Speedlites.

- ⚠ If flash exposure compensation is set with the Speedlite, you cannot set the flash exposure compensation with the camera. Note that the Speedlite's setting overrides the camera's if both are set at the same time.

● Flash exposure bracketing

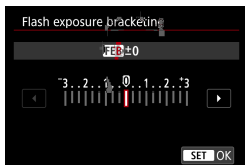

External Speedlites equipped with flash exposure bracketing (FEB) can change the external flash output automatically as three shots are taken at once.

External Flash Custom Function Settings

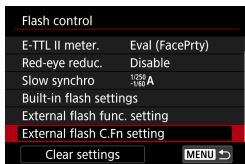

For details on the external Speedlite's Custom Functions, refer to the Speedlite's Instruction Manual.



- With an EL/EX series Speedlite, the Speedlite will always fire at full output if the **[Flash metering mode]** Custom Function is set to **[TTL flash metering]** (autoflash).
- The external Speedlite's Personal Function (P.Fn) cannot be set or canceled from the camera's **[📷: External Speedlite control]** screen. Set it directly on the external Speedlite.

Clearing Flash Function Settings/Flash C.Fn Settings ☆

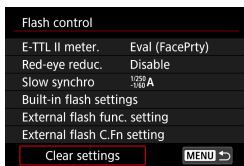

1 Select **[Clear settings]**.

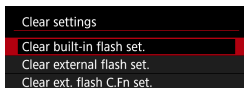

2 Select the settings to be cleared.

- Select **[Clear built-in flash set.]**, **[Clear external flash set.]**, or **[Clear ext. flash C.Fn set.]**.
- On the confirmation dialog, select **[OK]**. Then the flash settings or Custom Function settings will all be cleared.

Shooting With External Speedlites

EL/EX Series Speedlites for EOS Cameras

The camera supports flash photography using all functions of EL/EX series Speedlites (sold separately).

For operation procedures, refer to the EL/EX series Speedlite's Instruction Manual.

Canon Speedlites Other Than the EL/EX Series

- With an EZ/E/EG/ML/TL-series Speedlite set to A-TTL or TTL autoflash mode, the flash can be fired at full output only. Set the camera's shooting mode to <M> or <Av> and adjust the aperture value before shooting.
- When using a Speedlite that has manual flash mode, shoot in the manual flash mode.

Non-Canon Flash Units

Sync Speed

The camera can synchronize with non-Canon compact flash units at up to 1/250 sec. With large studio flash units, the flash duration is longer than that of a compact flash unit and varies depending on the model. Be sure to check before shooting if flash sync is properly performed by test shooting at a sync speed of approx. 1/60 sec. to 1/30 sec.



- Retract the built-in flash before attaching an external Speedlite.
- When using an external Speedlite in Live View shooting, set [📷: Shutter mode] to an option other than [Electronic] (📖 243).
- If the camera is used with a flash unit or flash accessory dedicated to another camera brand, the camera not only may not operate properly, but malfunction may result.
- Do not attach a high-voltage flash unit to the camera's hot shoe. It may not be fired.

Wireless Flash Photography Using Optical Transmission



You can use the built-in flash as the sender for external Canon Speedlites compatible with optical wireless flash photography to shoot with wireless multiple-flash lighting.

Receiver Setup and Positioning

Referring to the instruction manual of the external Speedlite (receiver), configure the following settings.

- Set up the Speedlite as a receiver.
- Set the camera and Speedlite to the same channel.
- To control the flash ratio, set the receiver's flash group.
- Position the camera and receiver within the following range.
- Arrange the receiver with its wireless sensor facing the camera.

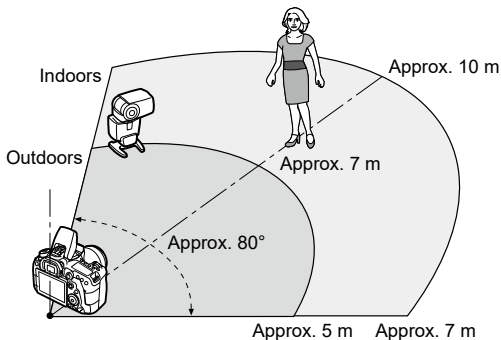

Canceling Receiver Auto Power Off

Press the camera's **< * >** button. For manual flash, cancel by pressing the receiver's test flash button.

Methods of Wireless Flash Photography Using Optical Transmission

	External Speedlite		Built-in Flash	Page	Settings	
	No. of Units	A:B Firing Ratio			Wireless Functions	Firing Group
Fully automatic shooting (E-TTL II autoflash)	1	—	—	182		All
	1	—	Used	184	:	—
	Multiple	—	—	185		All
	Multiple	Settings	—	186		(A:B)
	Multiple	—	Used	187	+	All and
	Multiple	Settings	Used		+	(A:B)
	• Flash exposure compensation				188	
• FE lock						

	External Speedlite		Built-in Flash	Page	Settings	
	No. of Units	A:B Firing Ratio			Wireless Functions	Firing Group
Manual flash	1/multiple	—	—	189		All
	Multiple	Settings	—			(A:B)
	1/multiple	—	Used		+	All and
	Multiple	Settings	Used		+	(A:B)

* / : external Speedlite; / : built-in flash



- To control receivers optically, the built-in flash fires even when you have set it to disable firing.

Fully Automatic Shooting With One Receiver

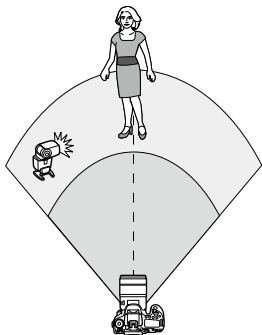

Fully automatic wireless flash photography using one receiver and one sender. Steps 1–4 and 6 apply to all wireless flash photography.

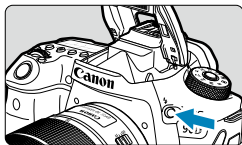

1 Press the <⚡> button.

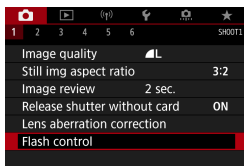

2 Select [Flash control].
● Select [: Flash control].

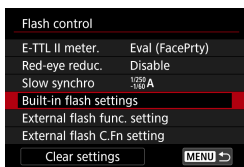

3 Select [Built-in flash settings].

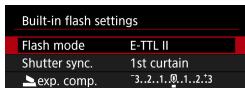

4 Set to [Flash mode: E-TTL II].

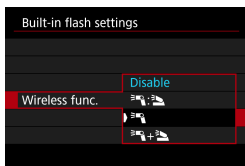

5 Set [Wireless func.] to [Disable].



6 Configure [Channel].

- Set the same optical channel (1–4) as the receiver.

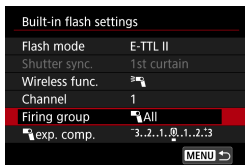

7 Set [Firing group] to [All].

8 Take the picture.

- Just as in normal flash photography, shoot after configuring the camera.
- To stop wireless flash photography, set [Wireless func.] to [Disable].

Autoflash With One Receiver

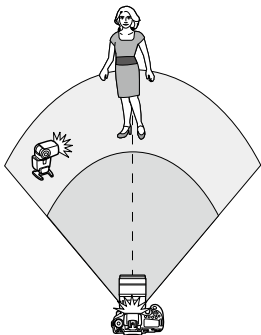

You can adjust how shadows form on subjects by changing the ratio of flash output from a receiver and a sender.

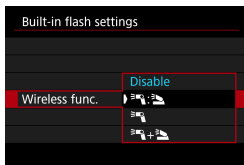

- 1 Set [Wireless func.] to [📷:📷].
 - Set [Wireless func.] to [📷:📷] as described in step 5 on [page 183](#).

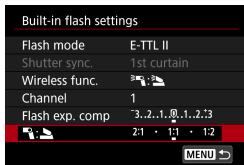

- 2 Set the ratio of flash output of the external Speedlite to the built-in flash.
 - Select [📷:📷] and set the flash ratio within 8:1 to 1:1.

- If there is insufficient flash output from the sender, increase the ISO speed ([page 213](#)).
- Flash ratios from 8:1 to 1:1 correspond to 3:1 to 1:1 (in 1/2-stop increments) when converted to number of stops of exposure.

Autoflash With Multiple Receivers

Multiple receivers can be treated as a single flash unit or, if you prefer to adjust the flash ratio, as separate groups.

Basic settings are as follows.

Built-in flash settings	
Flash mode	E-TTL II
Shutter sync.	1st curtain
Wireless func.	
Channel	1
Firing group	
exp. comp.	3..2..1..0..1..2:3

Set these basic settings.

Flash mode : E-TTL II

Wireless functions :

Channel : (same as receiver)

● [All] Firing multiple receivers as a single flash unit

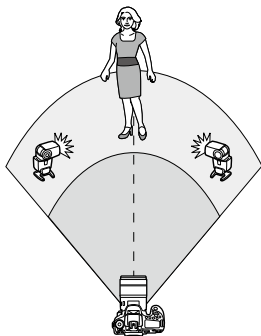

All flash units fire at the same output, and the total, combined output is automatically controlled to provide standard exposure.

Built-in flash settings	
Flash mode	E-TTL II
Shutter sync.	1st curtain
Wireless func.	
Channel	1
Firing group	
exp. comp.	3..2..1..0..1..2:3

Set [Firing group] to [All].

● [A:B] Autoflash with two receiver groups

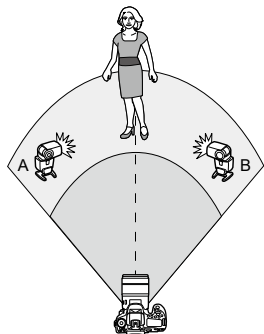

Receivers can be assigned as flash groups A and B, and you can adjust the relative output of each.

Exposure is automatically controlled, so that the groups' combined output provides standard exposure.

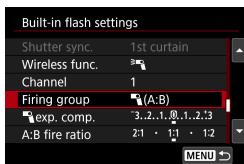

1 Set [Firing group] to [A:B].

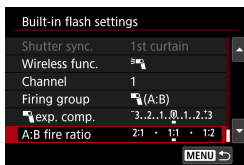

2 Set [A:B fire ratio].

● Flash units in group C will not fire when [Flash group] is set to [A:B].

● Flash ratios from 8:1 to 1:1 correspond to 3:1 to 1:1 (in 1/2-stop increments) when converted to number of stops of exposure.

Autoflash With Multiple Receivers and a Sender

You can include a sender in the wireless flash photography arrangements described from 185 to 186.

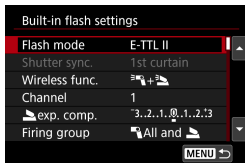

- Set these basic settings.**
 - Flash mode : E-TTL II
 - Wireless functions : +
 - Channel : (same as receiver)

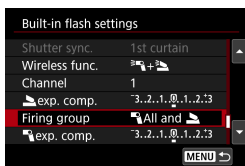

- Set [Firing group].**
 - Select [All and] or [(A:B)].
 - Before shooting with [(A:B)], set the A:B flash ratio.

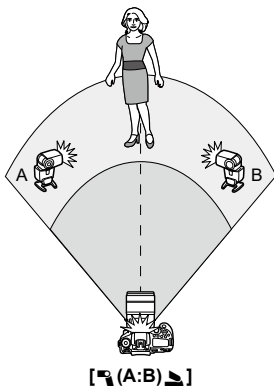
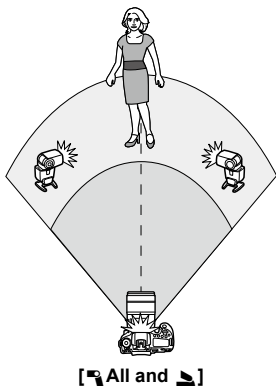

Advanced Wireless Flash Photography

● Flash exposure compensation

Available when **[Flash mode]** is set to **[E-TTL II]**. Note that the setting items available for flash exposure compensation (see below) vary depending on **[Wireless func.]** and **[Firing group]** setting details.

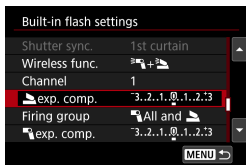

Flash exposure compensation

- The same amount of flash exposure compensation is set for the built-in flash and all external Speedlites.

Flash exposure compensation

- Set flash exposure compensation for the sender.

Flash exposure compensation





- The same amount of flash exposure compensation is set for all receivers.

● FE lock



You can lock the flash exposure (FE Lock,  167) by pressing the **< * >** button.

Wireless Multiple-Flash Photography with Specified Output





Available when **[Flash mode]** is set to **[Manual flash]**. Available flash output options (such as **[Flash output]** and **[Group A output]**) vary depending on **[Wireless func.]** setting details (see below).

Built-in flash settings	
Flash mode	Manual flash
Shutter sync.	1st curtain
Wireless func.	
Channel	1
Flash output	1/4 . 1/2 . 1/1
Firing group	 All and 
MENU 	

Wireless functions:

- **Firing group:  All**
The same manual flash output is set for all receivers.
- **Firing group:  (A:B)**
Receivers can be assigned to flash groups A or B, and you can set the flash output of each.

Wireless functions: +

- **Firing group:  All and **
You can set the flash output of senders and receivers separately.
- **Firing group:  (A:B) **
Receivers can be assigned to flash groups A or B, and you can set the flash output of each. Flash output can also be set for the sender.

Shooting

This chapter describes shooting and introduces menu settings on the shooting ([📷]) tab.

Still Photo Shooting

- A ☆ icon to the right of a page title indicates that the function is available only in Creative Zone.

Tab Menus: Still Photo Shooting (Viewfinder Shooting)

● Shooting 1

1	2	3	4	5	6	SHOOT1
	Image quality	L				199
	Still img aspect ratio	3:2				202
	Image review	2 sec.				204
	Release shutter without card	ON				205
	Lens aberration correction					206
	Flash control					168

● Shooting 2

1	2	3	4	5	6	SHOOT2
	Expo.comp./AEB	3..2..1..0..1..2..3				211
	ISO speed settings					213
	Auto Lighting Optimizer					218
	Highlight tone priority	OFF				219

● Shooting 3

1	2	3	4	5	6	SHOOT3
	White balance	AWB				224
	Custom White Balance					225
	WB Shift/Bkt.	0,0/±0				227
	Color space	sRGB				229
	Picture Style	Auto				230, 233, 236

● Shooting 4

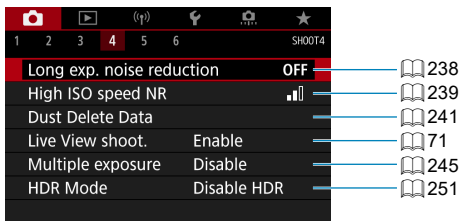

● Shooting 5

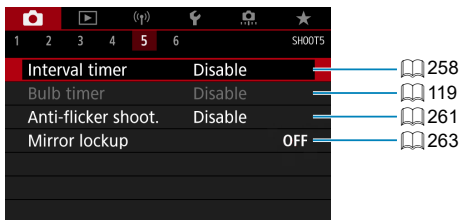

● Shooting 6

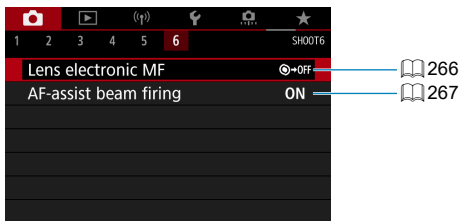

In Basic Zone modes, the following screens are displayed. Note that available setting items vary by shooting mode.

● Shooting 1

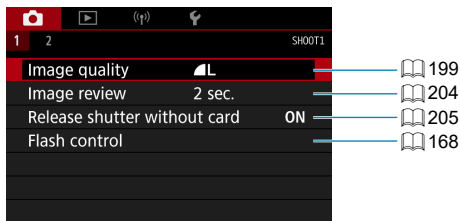

● Shooting 2

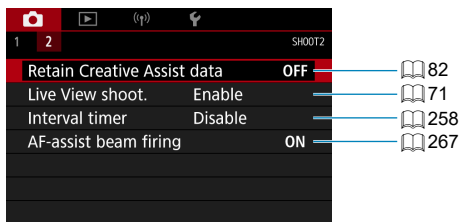

Tab Menus: Still Photo Shooting (Live View Shooting)

● Shooting 1

1	2	3	4	5	6	SHOOT1
Image quality					L	199
Still img aspect ratio					3:2	202
Image review					2 sec.	204
Release shutter without card					ON	205
Lens aberration correction						206
Flash control						168

● Shooting 2

1	2	3	4	5	6	SHOOT2
Expo.comp./AEB					3..2..1..0..1..2..3	211
ISO speed settings						213
Auto Lighting Optimizer						218
Highlight tone priority					OFF	219
Metering timer					8 sec.	220
Expo. simulation					Enable	221

● Shooting 3

1	2	3	4	5	6	SHOOT3
White balance					AWB	224
Custom White Balance						225
WB Shift/Bkt.					0,0/±0	227
Color space					sRGB	229
Picture Style					Auto	230, 233, 236

● Shooting 4

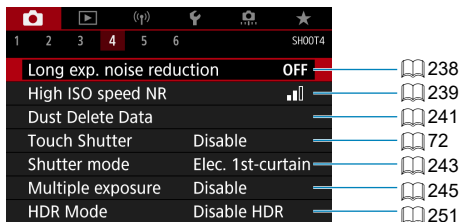

● Shooting 5

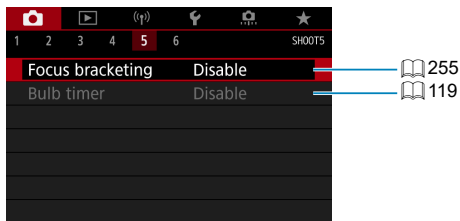

● Shooting 6

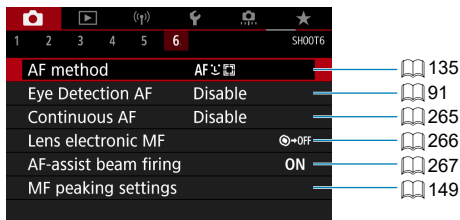

In **Basic Zone** modes, the following screens are displayed.
Note that available setting items vary by shooting mode.

● Shooting 1

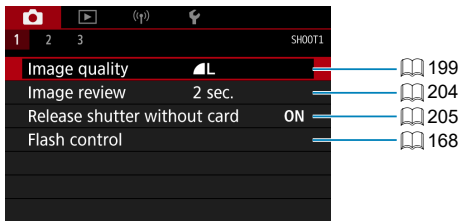

● Shooting 2

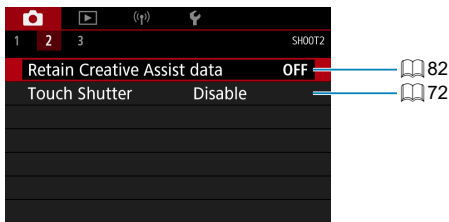

● Shooting 3

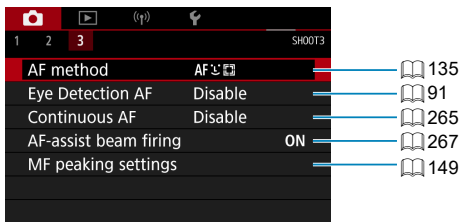
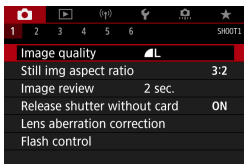
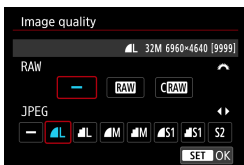

Image Quality Settings



1 Select [: Image quality].



2 Set the image quality.

- To select the RAW quality, turn the dial, and to select the JPEG quality, press the <◀> <▶> keys.
- Press <SET> to set it.





- Number of shots available as indicated by [****] on the image quality setting screen always applies to a setting of [3:2], regardless of the actual aspect ratio setting (📖 202).



- If [-] is set for both the RAW image and JPEG image, will be set.
- If you select both RAW and JPEG, each time you shoot, the image will be recorded simultaneously to the card in both RAW and JPEG at the image-recording qualities that were set. The two images will be recorded with the same file numbers (file extension: .JPG for JPEG and .CR3 for RAW).
- **S2** is in (Fine) quality.
- Meaning of image quality icons: **RAW** RAW, **CRAW** Compact RAW, JPEG, Fine, Normal, **L** Large, **M** Medium, **S** Small.

RAW Images

RAW images are raw data from the image sensor that are recorded to the card digitally as **RAW** or **CRRAW** (smaller than **RAW**) files, depending on your selection.

RAW images can be processed using []: **RAW image processing** ( 364) to save them as JPEGs. As the RAW image itself does not change, you can process the RAW image to create any number of JPEG images with various processing conditions.

You can use Digital Photo Professional (EOS software) to process RAW images. You can make various adjustments to images depending upon how they will be used and can generate JPEG or other types of images reflecting the effects of those adjustments.



- To display RAW images on a computer, using Digital Photo Professional (hereafter DPP, EOS software) is recommended.
- Older versions of DPP (Ver.4.x) do not support display, processing, editing, or other operations with RAW images captured by this camera. If a previous version of DPP (Ver.4.x) is installed on your computer, obtain and install the latest version of DPP from the Canon website to update it ( 590). (The previous version will be overwritten.) Similarly, DPP Ver.3.x or earlier does not support display, processing, editing, or other operations with RAW images captured by this camera.
- Commercially available software may not be able to display RAW images taken with this camera. For compatibility information, contact the software manufacturer.

Guide to Image Quality Settings

For guidelines on file sizes, number of possible shots, and maximum burst shots, see  615.

Maximum Burst for Continuous Shooting



The approximate maximum burst is shown on the shooting screen and in the lower right of the viewfinder.



- If the maximum burst is displayed as "99", it indicates that you can shoot 99 or more shots continuously. The value starts decreasing once it reaches 98 or less. **[buSY]** display in the viewfinder and LCD panel indicates that the internal buffer memory is full and shooting will stop temporarily. If you stop continuous shooting, the maximum burst will increase. After all the captured images are written to the card, you can resume continuous shooting and shoot up to the maximum burst listed in the table on 615.

Still Image Aspect Ratio



You can change the image's aspect ratio.

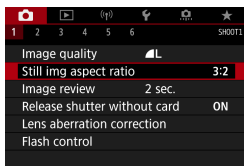

1 Select [: Still img aspect ratio].

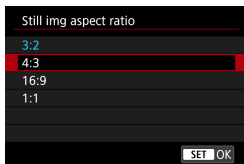

2 Set the aspect ratio.







- Select an aspect ratio, then press < >.

• JPEG images

The images will be recorded with the set aspect ratio.

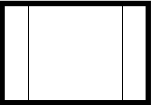
• RAW images

The images will always be recorded in the **[3:2]** aspect ratio. The selected aspect ratio information is added to the RAW image file. When you process the RAW image with Digital Photo Professional (EOS software), this allows you to generate an image with the same aspect ratio set for shooting.

	Aspect Ratio		
	4:3	16:9	1:1
With viewfinder shooting			
With Live View shooting			



- The picture will be taken at the **[3:2]** aspect ratio setting for the multiple-exposures.



- When you play back RAW images shot in the **[4:3]**, **[16:9]**, or **[1:1]** aspect ratio, they will be displayed with lines indicating the respective aspect ratio. (These lines are not recorded in the image.)

Image Review Time

To keep the captured image displayed, set **[Hold]**. To not have the captured image displayed, set **[Off]**.

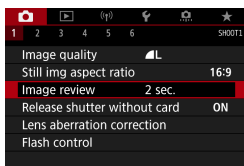

1 Select **[📷: Image review]**.

2 Set a time option.



- When **[Hold]** is set, images are displayed until the time set in **[🔌: Auto power off]** elapses.

Card Reminder

You can set the camera not to shoot unless there is a card in the camera. The default setting is **[Enable]**.

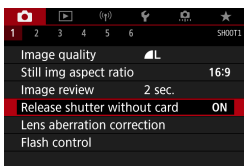

1 Select [: Release shutter without card].

2 Select [Disable].

Correction of Lens Aberrations due to Optical Characteristics



Vignetting, image distortion, and other issues may be caused by lens optical characteristics. The camera can compensate for these phenomena by using **[Lens aberration correction]**.

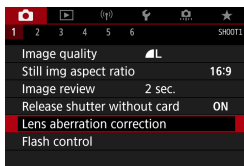

1 Select [: Lens aberration correction].

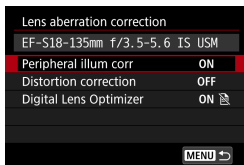

2 Select an item.

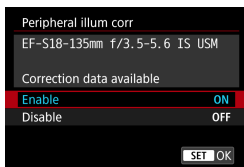

3 Select [**Enable**].

- Confirm that the name of the attached lens and (except for diffraction correction) **[Correction data available]** are displayed.
- If **[Correction data not available]** or is displayed, see “Digital Lens Optimizer” on 208.

Peripheral Illumination Correction

Vignetting (dark image corners) can be corrected.



- Depending on shooting conditions, noise may appear on the image periphery.
- The higher the ISO speed, the lower the correction amount will be.



- The correction amount applied will be lower than the maximum correction amount that applied with Digital Photo Professional (EOS software).
- Peripheral illumination is corrected automatically in Basic Zone modes when correction data is registered on the camera.

Distortion Correction

Distortion (image warping) can be corrected.



- To correct distortion, the camera captures a narrower image area than the area seen when shooting, which crops the image a little and slightly lowers the apparent resolution.
- Setting distortion correction may change the angle of view slightly.
- When you magnify images, distortion correction is not applied to the images displayed.
- Distortion correction is not applied in movie recording.
- Images with distortion correction applied will not have the Dust Delete Data ((241) appended. Also, the AF point may be displayed out of position, relative to the time of shooting.



- Distortion is corrected automatically when <SCN> mode is set to < > mode and correction data is registered on the camera.

Digital Lens Optimizer

Various aberrations from lens optical characteristics can be corrected, along with diffraction and low-pass filter-induced loss of clarity.

If **[Correction data not available]** or  is displayed by **[Digital Lens Optimizer]**, you can use EOS Utility to add the lens correction data to the camera. For details, refer to the EOS Utility Instruction Manual.



- Depending on shooting conditions, noise may be intensified together with the effects of correction. Image edges may also be emphasized. Adjust Picture Style sharpness or set **[Digital Lens Optimizer]** to **[Disable]** as needed before shooting.
- The higher the ISO speed, the lower the correction amount will be.
- For movie recording, **[Digital Lens Optimizer]** will not appear. (Correction is not possible.)



- Enabling **[Digital Lens Optimizer]** corrects both chromatic aberration and diffraction, although these options are not displayed.
- Digital Lens Optimizer is applied automatically in Basic Zone modes when correction data is registered on the camera.

Chromatic Aberration Correction

Chromatic aberration (color fringing around subjects) can be corrected.



- **[Chromatic aberr corr]** is not displayed when **[Digital Lens Optimizer]** is enabled.

Diffraction Correction

Diffraction (loss of sharpness caused by the aperture) can be corrected.



- Depending on shooting conditions, noise may be intensified together with the effects of correction.
- The higher the ISO speed, the lower the correction amount will be.
- For movie recording, **[Diffraction correction]** will not appear. (Correction is not possible.)



- With "Diffraction correction", degraded resolution due to the low-pass filter, etc. is corrected in addition to diffraction. Therefore, correction is effective even at an aperture close to the open aperture.
- **[Diffraction correction]** is not displayed when **[Digital Lens Optimizer]** is enabled.



General Cautions for Lens Aberration Correction

- Peripheral illumination correction, chromatic aberration correction, distortion correction, and diffraction correction cannot be applied to JPEG images already taken.
- When using a non-Canon lens, setting the corrections to **[Disable]** is recommended even if **[Correction data available]** is displayed.
- Magnifying the periphery of the image may display parts of the image that will not be recorded.
- The correction amount will be less (except for diffraction correction) if the lens used does not have distance information.



General Notes for Lens Aberration Correction

- The effect of the lens aberration correction varies depending on the lens used and shooting conditions. Also, the effect may be difficult to discern depending on the lens used, shooting conditions, etc.
- If the correction is difficult to discern, magnifying and checking the image after shooting is recommended.
- Corrections can be applied even when an extender or life-size converter is attached.
- If the correction data for the attached lens is not registered to the camera, the result will be the same as when the correction is set to **[Disable]** (except for diffraction correction).
- If necessary, refer to the EOS Utility Instruction Manual as well.

Auto Exposure Bracketing (AEB)



You can capture three images at different shutter speeds, aperture values, and ISO speeds, as adjusted by the camera. This is called AEB.

* AEB stands for Auto Exposure Bracketing.

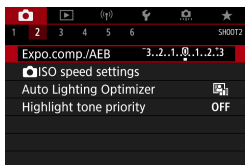

1 Select [📷: Expo.comp./AEB].

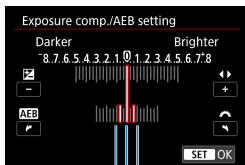

2 Set the AEB range.

- Turn the dial to set the AEB range (1). Press the keys to set the exposure compensation level.
- Press to set it.
- When you close the menu, the AEB range will be displayed on the screen.

(1)

Standard exposure



Decreased exposure



Increased exposure



3 Take the picture.

- Three bracketed shots will be taken according to the drive mode set in this sequence: Standard exposure, decreased exposure, and increased exposure.
- AEB will not be automatically canceled. To cancel AEB, follow step 2 to turn off the AEB range display.



- If [: **Auto Lighting Optimizer**] (📖 218) is set to any setting other than [**Disable**], the effect of AEB may be reduced.



- If the drive mode is set to <📷>, press the shutter button three times for each shot. When <📷H> or <📷> is set and you hold down the shutter button completely, the three bracketed shots will be taken consecutively and the camera will automatically stop shooting. When <📷10> or <📷2> is set, the three bracketed shots will be taken consecutively after a 10-sec. or 2-sec. delay. When set to <📷c>, three times the specified number of shots are taken in continuous shooting.
- You can set AEB in combination with exposure compensation.
- AEB cannot be used with flash, Multi Shot Noise Reduction, focus bracketing, or in HDR mode.
- AEB will be canceled automatically if you do any of the following: Setting the power switch to <OFF> or when the flash is fully charged.

ISO Speed Settings for Still Photos



Set the ISO speed (image sensor's sensitivity to light) to suit the ambient light level. In Basic Zone modes, ISO speed is set automatically. Regarding the ISO speed during movie recording, see 620.

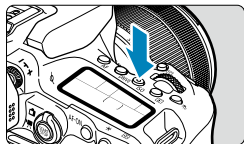

1 Press the <ISO> button (6).

- You can also press the <Q> button and configure this setting from the Quick Control screen.

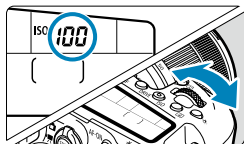

2 Set the ISO speed.

- Turn the <ISO> or <ISO> dial.
- Select **[A]** or **[AUTO]** to set the ISO speed automatically (614).

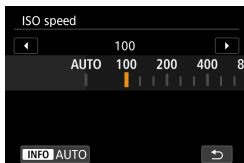

ISO Speed Guide

- Low ISO speeds reduce image noise but may increase the risk of camera/subject shake or reduce the area in focus (shallower depth of field), in some shooting conditions.
- High ISO speeds enable low-light shooting, a larger area in focus (deeper depth of field), and longer flash range but may increase image noise.

- Image noise (such as dots of light or banding) may increase and apparent resolution may decrease at H (equivalent to ISO 51200), because this is an expanded ISO speed.
- ISO 100/125/160 or an expanded ISO speed cannot be selected when **[📷: Highlight tone priority]** is set to **[Enable]** or **[Enhanced]** (📖 219).
- When shooting with a high ISO speed, high temperature, long exposure, or multiple exposure, image noise (rough grain, dots of light, banding, etc.), irregular colors, or color shift may become noticeable.
- When shooting in conditions that produce an extreme amount of noise, such as a combination of high ISO speed, high temperature, and long exposure, images may not be recorded properly.
- If you use a high ISO speed and flash to shoot a close subject, overexposure may result.

ISO Speed Range When Set Manually

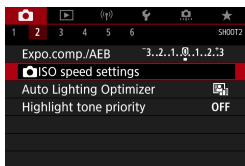

1 Select [: ISO speed settings].

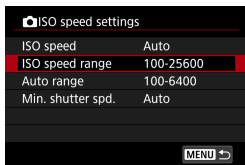

2 Select [ISO speed range].

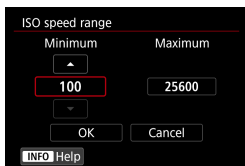

3 Set the minimum limit.

- Select the minimum limit box, then press <SET>.
- Select the ISO speed, then press <SET>.

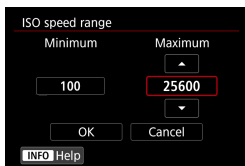

4 Set the maximum limit.

- Select the maximum limit box, then press <SET>.
- Select the ISO speed, then press <SET>.

5 Select [OK].

ISO Speed Range Used With ISO Auto

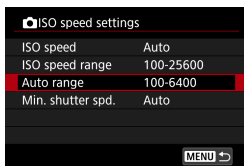

1 Select [Auto range].



2 Set the minimum limit.

- Select the minimum limit box, then press <SET>.
- Select the ISO speed, then press <SET>.



3 Set the maximum limit.

- Select the maximum limit box, then press <SET>.
- Select the ISO speed, then press <SET>.

4 Select [OK].

- The [Minimum] and [Maximum] settings will also function as the minimum and maximum speeds for ISO speed safety shift (📖 558).

Minimum Shutter Speed for ISO Auto

This can help reduce camera shake and subject blur in <P> or <Av> mode when shooting moving subjects with a wide-angle lens, or when using a telephoto lens.

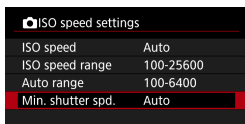

1 Select [Min. shutter spd.].

Automatically set

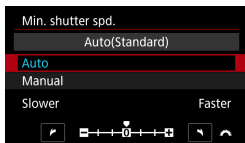

2 Set the desired minimum shutter speed.

- If you select **[Auto]**, turn the <⚙> dial to set a slower or faster speed, then press <SET>.
- If you select **[Manual]**, turn the <⚙> dial to select the shutter speed, then press <SET>.

Manually set

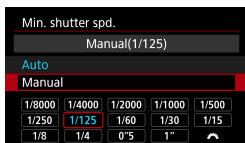

- If a correct exposure cannot be obtained with the maximum ISO speed limit set with **[Auto range]**, a shutter speed slower than the **[Min. shutter spd.]** will be set to obtain the standard exposure.
- This function will not be applied to flash photography and movie recording.





- When **[Auto(Standard)]** is set, the minimum shutter speed will be the reciprocal of the lens focal length. A single step from **[Slower]** to **[Faster]** is equivalent to a single stop of the shutter speed.

Auto Correction of Brightness and Contrast (Auto Lighting Optimizer)

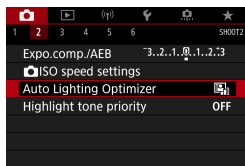

Brightness and contrast can be corrected automatically if shots look dark or contrast is too low or high.



1 Select [: Auto Lighting Optimizer].

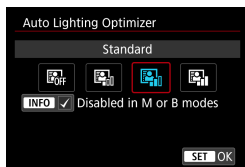

2 Set a correction option.

- Noise may increase and clarity may change, under some shooting conditions.
- If the effect of Auto Lighting Optimizer is too strong and results are not at your preferred brightness, set to **[Low]** or **[Disable]**.
- If a setting other than **[Disable]** is set and you use exposure compensation or flash exposure compensation to darken the exposure, the image may still come out bright. If you want a darker exposure, set this function to **[Disable]**.
- Maximum burst is lower with **[High]**. Image recording to the card also takes longer.

- In step 2, if you press the <INFO> button and remove the checkmark [✓] for **[Disabled in M or B modes]** setting, [: Auto Lighting Optimizer] can also be set even in <M> and modes.



Highlight Tone Priority Settings

You can reduce overexposed, clipped highlights.

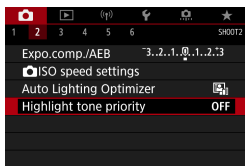

1 Select []: Highlight tone priority].

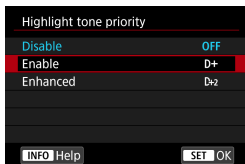

2 Set an option.

- **[Enable]**: Improves gradation in highlights. The gradation between the grays and highlights becomes smoother.
- **[Enhanced]**: Reduces overexposed highlights even more than **[Enable]**, under some shooting conditions.



- Noise may increase slightly.
- The available ISO range starts at ISO 200. Expanded ISO speeds cannot be set.
- **[Enhanced]** is not available when recording movies.
- With **[Enhanced]**, results in some scenes may not look as expected.

Metering Timer (Live View Shooting) ☆

You can set how long the metering timer runs (which determines the duration of exposure display/AE lock) after it is triggered by an action such as pressing the shutter button halfway.

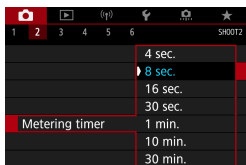

1 Select [: Metering timer].

2 Set a time option.

Exposure Simulation (Live View Shooting)

Exposure simulation simulates and displays how the brightness (exposure) of the actual image will look.

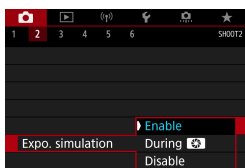

1 Select [: Expo. simulation].

2 Set an option.

● Enable ()

The displayed image brightness will be close to the actual brightness (exposure) of the resulting image. If you set exposure compensation, the image brightness will change accordingly.

● During ()

Normally, the image is displayed at standard brightness, so it is easy to see (). Image brightness will only be close to the actual brightness (exposure) of the resulting image while you hold down the button you have assigned to [**Depth-of-field preview**] (using [. C.Fn III-3 : **Customize buttons**], (571)) ().

● Disable ()

The image is displayed at standard brightness, so it is easy to see. Even if you set exposure compensation, the image is displayed at the standard brightness.

White Balance Settings



White balance (WB) is for making the white areas look white. Normally, the Auto [AWB] (Ambience priority) or [AWB w] (White priority) setting will obtain the correct white balance. If natural-looking colors cannot be obtained with Auto, you can select the white balance to match the light source or set it manually by shooting a white object.

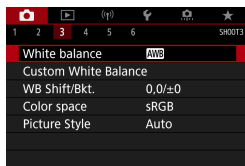

1 Select [: White balance].

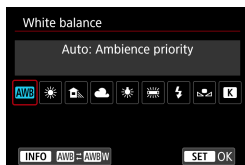

2 Select an item.

(Approx.)

Display	Mode	Color Temperature (K: Kelvin)
	Auto (Ambience priority, 224)	3000–7000
	Auto (White priority, 224)	
	Daylight	5200
	Shade	7000
	Cloudy, twilight, sunset	6000
	Tungsten light	3200
	White fluorescent light	4000
	Flash	Automatically set*
	Custom (225)	2000–10000
	Color temperature (226)	2500–10000

* Applicable with Speedlites having a color temperature transmission function. Otherwise, it will be fixed to approx. 6000K.

White Balance

To the human eye, a white object looks white regardless of the type of lighting. With a digital camera, the white for color correction basis is decided depending on the color temperature of the illumination, and then the color is adjusted with software to make the white areas look white. With this function, you can take the pictures with natural color tones.

[AWB] Auto White Balance

With [AWB], you can slightly increase the intensity of the image's warm color cast when shooting a tungsten-light scene. If you select [AWB w], you can reduce the intensity of the image's warm color cast.

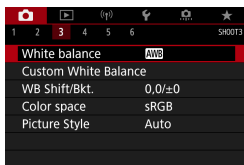

1 Select [📷: White balance].

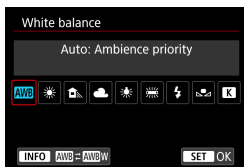

2 Select [AWB].
 • With [AWB] selected, press the <INFO> button.

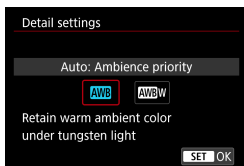

3 Select an item.

⚠ Cautions for Setting [AWB w]

- The warm color cast of subjects may fade.
- When multiple light sources are included in the scene, the warm color cast of the picture may not be reduced.
- When using flash, the color tone will be the same as with [AWB].

[] Custom White Balance

With custom white balance, you can manually set the white balance for the specific light source of the shooting location. Make sure to perform this procedure under the light source at the actual location of the shoot.

1 Shoot a white object.

- Aim the camera at a plain white subject, so that white fills the screen.
- Focus manually and shoot with the standard exposure set for the white object.
- You can use any of the white balance settings.

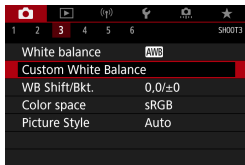

2 Select [: Custom White Balance].



3 Import the white balance data.

- Press the <◀> <▶> keys to select the image captured in step 1, then press <SET>.
- Select [OK] to import the data.

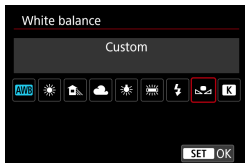

4 Select [: White balance].

5 Select the custom white balance.

- Select [].

- If the exposure obtained in step 1 differs greatly from the standard exposure, a correct white balance may not be obtained.
- These images cannot be selected: Images captured with Picture Style set to **[Monochrome]**, images with a Creative filter applied before or after shooting, multiple-exposure images, cropped images, or images shot with another camera.
- Images that cannot be used in the setting may be displayed.

- Instead of shooting a white object, you can also shoot a gray chart or standard 18% gray reflector (commercially-available).

[K] Color Temperature

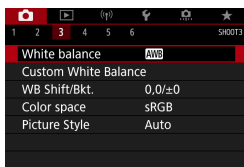

1 Select [: White balance].

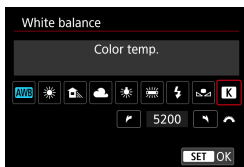

2 Set the color temperature.

- Select [**K**].
- Turn the < > dial to set the desired color temperature, then press <(SET)>.
- The color temperature can be set from approx. 2500K to 10000K in 100K increments.

- When setting the color temperature for an artificial light source, set the white balance correction (magenta or green bias) as necessary.
- If you set [**K**] to the reading taken with a commercially available color temperature meter, take test shots and adjust the setting to compensate for the difference between the color temperature meter's reading and the camera's color temperature reading.

White Balance Correction



White balance correction has the same effect as using a commercially available color temperature conversion filter or color compensating filter.

White Balance Correction

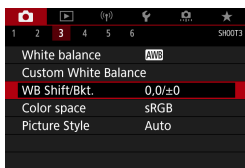

1 Select [: WB Shift/Bkt.].

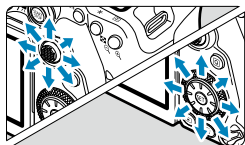

2 Set the white balance correction.

- Use < > < > to move the “•” mark to your preferred position.
- B is for blue, A for amber, M for magenta, and G for green. The image's color balance will be adjusted toward the color in the direction of the move. On the right of the screen, “**Shift**” indicates the direction and correction amount, respectively.
- Pressing the < > button will cancel all the [WB Shift/Bkt.] settings.
- Press < > to exit the setting.

Sample setting: A2, G1

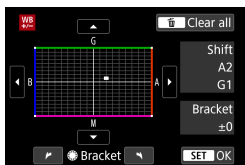

- One level of the blue/amber correction is equivalent to approx. 5 mireds of a color temperature conversion filter. (Mired: Unit of measure for color temperature used to indicate values such as the density of a color temperature conversion filter.)

White Balance Auto Bracketing

White balance bracketing (WB Bkt.) enables you to capture three images at once with different color tones.

B/A bias ± 3 levels

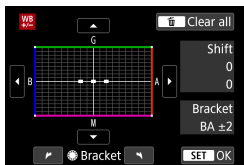

Set the white balance bracketing amount.

- In step 2 for “White Balance Correction”, when you turn the $\langle \text{WB} \rangle$ dial, the “■” mark on the screen will change to “■■■” (3 points).
- Turning the dial clockwise sets the B/A bracketing, and turning it counterclockwise sets the M/G bracketing. On the right, “**Bracket**” indicates the bracketing direction and correction amount.
- Pressing the $\langle \text{Clear} \rangle$ button will cancel all the [WB Shift/Bkt.] settings.
- Press $\langle \text{SET} \rangle$ to exit the setting.

- During white balance bracketing, the maximum burst for continuous shooting will be lower.
- Since three images are recorded for one shot, it takes longer to record the image to the card.

- The images will be bracketed in the following sequence: 1. Standard white balance, 2. Blue (B) bias, and 3. Amber (A) bias, or 1. Standard white balance, 2. Magenta (M) bias, and 3. Green (G) bias.
- You can also set white balance correction and AEB together with white balance bracketing. If you set AEB in combination with white balance bracketing, a total of nine images will be recorded for a single shot.
- The white balance icon blinks when white balance bracketing is set in Live View shooting.
- “**Bracket**” stands for bracketing.

Color Space Settings

The range of reproducible colors is called “color space”. For normal shooting, sRGB is recommended.

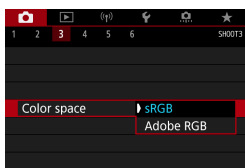

1 Select [📷: Color space].

2 Set a color space option.

Adobe RGB

This color space is mainly used for commercial printing and other industrial uses. Recommended when using equipment such as Adobe RGB-compatible monitors or DCF 2.0 (Exif 2.21 or later) compatible printers.



- If the still photo is shot in the Adobe RGB color space, the first character in the file name will be an underscore “_”.
- The ICC profile is not appended. For the descriptions about the ICC profile, refer to the Digital Photo Professional Instruction Manual (EOS software).
- In Basic Zone modes, [sRGB] is set automatically.

Picture Style Selection



Just by selecting a preset Picture Style, you can obtain image characteristics effectively matching your photographic expression or the subject.

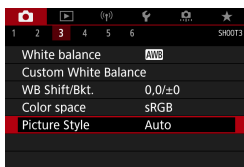

1 Select []: Picture Style].



2 Select a Picture Style.

Picture Style Characteristics

● [] Auto

The color tone will be adjusted automatically to suit the scene. The colors will look vivid for blue skies, greenery and sunsets, particularly in nature, outdoor and sunset scenes.



● If the desired color tone is not obtained with [**Auto**], use another Picture Style.

● [] Standard

The image looks vivid, sharp, and crisp. This is a general-purpose Picture Style suitable for most scenes.

● [] Portrait

For nice skin tones. The image looks softer. Suited for close-up portraits. By changing the [**Color tone**] (234), you can adjust the skin tone.

-  **Landscape**

For vivid blues and greens, and very sharp and crisp images. Effective for impressive landscapes.

-  **Fine Detail**

Suited for detailed outline and fine texture description of the subject. The colors will be slightly vivid.

-  **Neutral**

Suited for processing the image with a computer. For natural colors and subdued images with modest brightness and color saturation.

-  **Faithful**

Suited for processing the image with a computer. The color of a subject that is captured in sunlight at a color temperature of 5200K will be adjusted to match the subject's colorimetric color. For subdued images with modest brightness and color saturation.



-  **Monochrome**

Creates black-and-white images.



- Color images cannot be recovered from JPEG images shot with the **[Monochrome]** Picture Style.



- You can set the camera to display <  > in the viewfinder for when **[Monochrome]** is set ( 570).

-  **User Defined 1–3**

You can register a basic style such as **[Portrait]**, **[Landscape]**, a Picture Style file, etc. and adjust it as desired ( 236). With any of the User Defined Picture Style that has not yet been set, pictures will be taken with the same characteristics settings as with the default settings of **[Auto]**.

Symbols

The Picture Style selection screen has icons for **[Strength]**, **[Fineness]**, or **[Threshold]** for **[Sharpness]** as well as **[Contrast]** and other settings. The numbers indicate the values for these settings specified for the respective Picture Style.

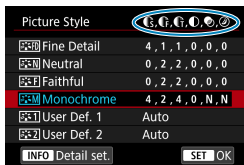
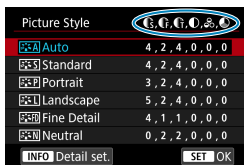

	Sharpness	
		Strength
		Fineness
		Threshold
	Contrast	
	Saturation	
	Color tone	
	Filter effect (Monochrome)	
	Toning effect (Monochrome)	

- During movie recording, an asterisk "*" will be displayed for both **[Fineness]** and **[Threshold]** for **[Sharpness]**. **[Fineness]** and **[Threshold]** will not be applied to movies.

Picture Style Customization

You can customize any Picture Style by changing it from the default settings. To customize **[Monochrome]**, see  235.

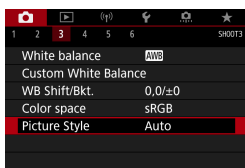

1 Select [: Picture Style].



2 Select a Picture Style.

- Select the Picture Style to adjust, then press the <INFO> button.

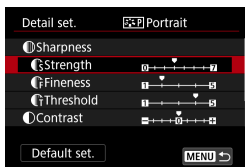

3 Select an item.

- See the next page for details on the settings and effects.

4 Set the effect level.

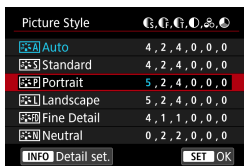

- Press the <MENU> button to save the adjusted setting and return to the Picture Style selection screen.
- Any settings you change from default values are displayed in blue.

Settings and Effects

●	Sharpness			
	●	Strength	0: Weak outline emphasis	7: Strong outline emphasis
	●	Fineness* ¹	1: Fine	5: Grainy
	●	Threshold* ²	1: Low	5: High
●	Contrast		-4: Low contrast	+4: High contrast
●	Saturation		-4: Low saturation	+4: High saturation
●	Color tone		-4: Reddish skin tone	+4: Yellowish skin tone

*1: Indicates the fineness of the outlines to be emphasized. The smaller the number, the finer the outlines that can be emphasized.

*2: Sets how much the outline is emphasized based on the difference in contrast between the subject and the surrounding area. The smaller the number, the more the outline will be emphasized when the contrast difference is low. However, noise tends to be more noticeable when the number is smaller.



- For movie recording, [Fineness] and [Threshold] for [Sharpness] cannot be set (not displayed).
- By selecting [Default set.] in step 3, you can revert the parameter settings of the respective Picture Style to their defaults.
- To shoot with the Picture Style you adjusted, first select the adjusted Picture Style, then shoot.

[] Monochrome Adjustment

[] Filter effect

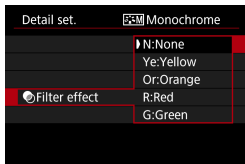

With a filter effect applied to a monochrome image, you can make white clouds or green trees stand out more.

Filter	Sample Effects
N: None	Normal black-and-white image with no filter effects.
Ye: Yellow	The blue sky will look more natural, and the white clouds will look crisper.
Or: Orange	The blue sky will look slightly darker. The sunset will look more brilliant.
R: Red	The blue sky will look quite dark. Fall leaves will look crisper and brighter.
G: Green	Skin tones and lips will appear muted. Green tree leaves will look crisper and brighter.



- Increasing **[Contrast]** will make the filter effect more pronounced.

[] Toning effect

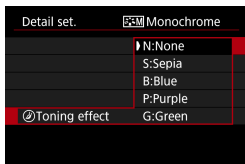

By applying a toning effect, you can create a monochrome image in the selected color. Effective when you want to create more impressive images.

Picture Style Registration



You can select a base Picture Style such as **[Portrait]** or **[Landscape]**, adjust it as desired, and register it under **[User Def. 1]**, **[User Def. 2]**, or **[User Def. 3]**. Useful when creating several Picture Styles with different settings.

Picture Styles that you have registered on the camera using EOS Utility (EOS software) can also be modified here.

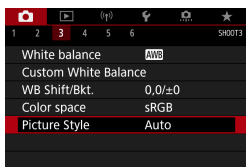

1 Select **[: Picture Style]**.

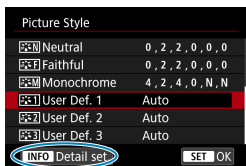

2 Select **[User Def.]**.

- Select **[User Def. *]**, then press the **<INFO>** button.

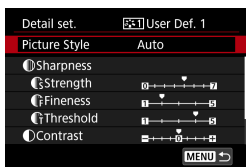

3 Press **<SET>**.

- With **[Picture Style]** selected, press **<SET>**.

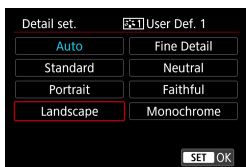

4 Select the base Picture Style.

- Select the base Picture Style.
- Also select styles this way when adjusting styles registered to the camera with EOS Utility (EOS software).

5 Select an item.

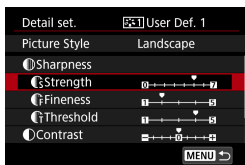

6 Set the effect level.

- For details, see “Picture Style Customization” (📖 233).

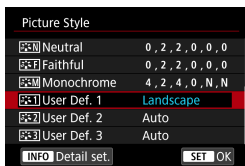
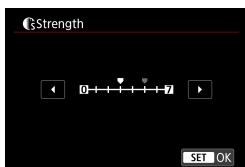

- Press the <MENU> button to save the adjusted setting and return to the Picture Style selection screen. The base Picture Style will be indicated on the right of **[User Def. *]**. Blue style names indicate that you have changed the settings from default values.



- If a Picture Style is already registered under **[User Def. *]**, changing the base Picture Style will clear the parameter settings of the previously registered User Defined Picture Style.
- If you perform [**W**: Clear all camera settings] (📖 547), all the **[User Def. *]** settings will revert to their defaults.



- To shoot with a registered Picture Style, select the registered **[User Def. *]**, then shoot.
- Regarding the procedure to register a Picture Style file to the camera, refer to the EOS Utility Instruction Manual.

Noise Reduction Settings



Long Exposure Noise Reduction

For images exposed for 1 sec. or longer, noise (dots of light and banding) typical of long exposures can be reduced.

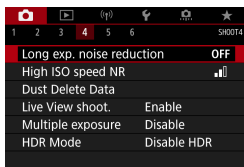

1 Select [: Long exp. noise reduction].

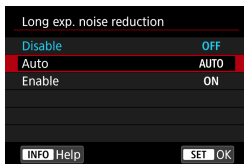

2 Set a reduction option.

● [AUTO] Auto

For exposures of 1 sec. or longer, noise reduction is performed automatically if noise typical of long exposures is detected. This [**Auto**] setting is effective enough in most cases.

● [ON] Enable

Noise reduction is performed for all exposures of 1 sec. or longer. The [**Enable**] setting may reduce noise that cannot be detected with the [**Auto**] setting.

- With [**Auto**] or [**Enable**] set, the noise reduction process after the picture is taken may take the same amount of time as that for the exposure.
- Images may look grainier with the [**Enable**] setting than with the [**Disable**] or [**Auto**] setting.
- With [**Enable**] set, noise reduction processing (indicated by “buSY” display) when you shoot long exposures during Live View display will pause Live View display, and you cannot shoot again until processing is finished.

High ISO Speed Noise Reduction

This function reduces the noise generated in the image. This function is especially effective when shooting at high ISO speeds. When shooting at low ISO speeds, the noise in the darker parts of the image (shadow areas) can further be reduced.

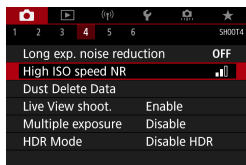

1 Select [: High ISO speed NR].

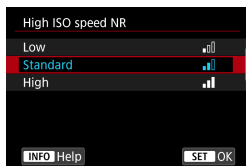

2 Set the level.

● [] Multi Shot Noise Reduction

Applies the noise reduction with higher image quality than [**High**]. For a single photo, four shots are taken continuously and aligned and merged automatically into a single JPEG image.

If the image quality is set to RAW or RAW+JPEG, you cannot set [**Multi Shot Noise Reduction**].



Cautions for Setting Multi Shot Noise Reduction

- If there is significant misalignment in the image due to camera shake, the noise reduction effect may become smaller.
- If you are handholding the camera, keep it steady to prevent camera shake. Using a tripod is recommended.
- If you shoot a moving subject, the moving subject may leave afterimages.
- Auto image alignment may not function properly with repetitive patterns (lattice, stripes, etc.) or flat, single-tone images.
- If the subject's brightness changes as the four consecutive shots are taken, irregular exposure in the image may result.
- After shooting, it may take some time to record an image to the card after performing noise reduction and merging the images. "buSY" appears in the viewfinder and on the LCD panel as images are processed, and shooting is not possible until processing is finished.
- **[Multi Shot Noise Reduction]** is not available with bulb shooting, shooting with AEB or WB bracketing, shooting RAW or RAW+JPEG images, or with features such as long exposure noise reduction, multiple exposures, or HDR mode.
- Flash photography is not possible. Note that the AF-assist beam of EOS-dedicated, external Speedlites will be emitted according to the **[📷: AF-assist beam firing]** setting.
- **[Multi Shot Noise Reduction]** is not available (not displayed) when recording movies.
- Automatically switches to **[Standard]** if you set the power switch to <OFF>, replace the battery or card, switch to a Basic Zone or shooting mode, or switch to movie recording.

Appending Dust Delete Data



Dust Delete Data used to erase dust spots can be appended to images in case sensor cleaning leaves dust on the sensor. The Dust Delete Data is used by Digital Photo Professional (EOS software) to erase the dust spots automatically.

Preparation

- Prepare a solid white object such as a sheet of paper.
- Set the lens focal length to 50 mm or longer.
- Set the lens's focus mode switch to <MF> and set the focus to infinity (∞).

Dust Delete Data Acquisition

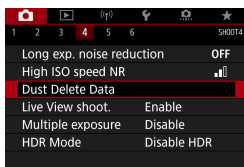

1 Select [: Dust Delete Data].

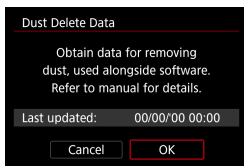

2 Select [OK].

- After the automatic self-cleaning of the sensor is performed, a message will appear. Although there will be a mechanical sound of the shutter during the cleaning, no picture is taken.

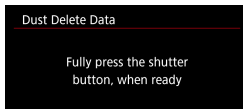
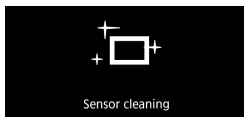

3 Shoot a plain white object.

- Shoot with a plain white object (such as a new sheet of white paper) filling the screen, at a distance of 20–30 cm (0.7–1.0 ft.).
- Since the image will not be saved, the data can still be obtained even if there is no card in the camera.

When the picture is taken, the camera will start collecting the Dust Delete Data. When the Dust Delete Data is obtained, a message will appear.

- If the data is not obtained successfully, an error message will appear. Follow the “Preparation” procedure on the preceding page, then select **[OK]**. Take the picture again.

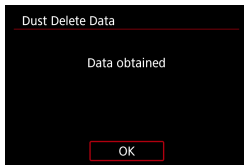

Dust Delete Data Appending

The camera will append the Dust Delete Data obtained to all shots from now on. Acquiring Dust Delete Data before shooting is recommended. For details about using Digital Photo Professional (EOS software) to erase dust spots automatically, refer to the Digital Photo Professional Instruction Manual.

File size is essentially unaffected by Dust Delete Data appended to images.

- If the object has any pattern or design, it may be recognized as dust data and affect the accuracy of the dust deletion with the Digital Photo Professional (EOS software).

Shutter Release Method (Live View Shooting)



You can choose how the shutter is released in Live View shooting.

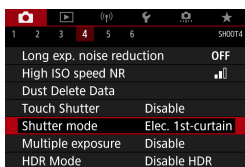

1 Select []: Shutter mode].

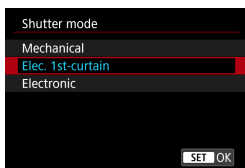

2 Select an item.

● Mechanical

Shooting activates the mechanical shutter. Be sure to set it to **[Mechanical]** if you use a TS-E lens (except TS-E17mm f/4L or TS-E24mm f/3.5L II) for shifting or tilting the lens or if you use an extension tube. If **[Elec. 1st-curtain]** or **[Electronic]** is set, the standard exposure may not be obtained, or an irregular exposure may result.

● Elec. 1st-curtain

Shooting only activates the second-curtain shutter. The shutter is quieter than with **[Mechanical]**.

● Electronic

Enables you to shoot at a maximum 1/16000 sec. shutter speed without a shutter sound.

Available with drive modes other than <H>, <L>, or <C>.

Flash photography is not possible.

-  ● **[Electronic]** is not available in viewfinder shooting with the drive mode set to H>, , or S>.
- Defocused image areas may be incomplete when shooting near maximum aperture at high shutter speeds, depending on shooting conditions. If you dislike the appearance of defocused image areas, shooting as follows may give better results.
 - Shoot without electronic first curtain.
 - Lower the shutter speed.
 - Increase the aperture value.
- With **[Electronic]**, camera shake or subject motion may cause image distortion.
- Setting the shutter mode to **[Electronic]** under flickering light may cause noticeable screen flickering, and images may be captured with horizontal stripes (noise) or irregular exposure.

Multiple Exposures

You can shoot multiple exposures to merge into a single image. With Live View shooting, you can see in real time how the exposures are merged when you shoot multiple-exposure images.

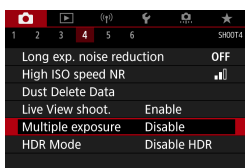

1 Select [**Multiple exposure**].

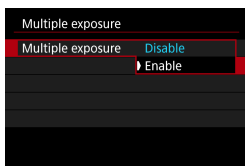

2 Set a [**Multiple exposure**] option.

- Select [**Enable**].
- To exit shooting multiple exposures, select [**Disable**].

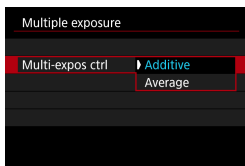

3 Set [**Multi-expos ctrl**].

● Additive

The exposure of each single image captured is added cumulatively. Based on the [**No. of exposures**], set a negative exposure compensation. Follow the basic guide below to set the exposure compensation amount.

Exposure Compensation Setting Guide by Number of Exposures

Two exposures: -1 stop, three exposures: -1.5 stop, four exposures: -2 stops

● Average

Based on the [**No. of exposures**], negative exposure compensation is set automatically as you shoot multiple exposures. If you shoot multiple exposures of the same scene, the exposure of the subject's background will be automatically controlled to obtain the standard exposure.



4 Set the [No. of exposures].

- Select the number of exposures, then press <SET>.

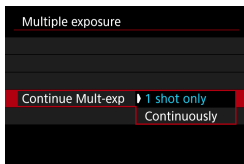

5 Set a [Continue Mult-exp] option.

- With **[1 shot only]**, multiple-exposure shooting will be canceled automatically after the shooting ends.
- With **[Continuously]**, multiple-exposure shooting continues until the setting in step 2 is set to **[Disable]**.



6 Shoot the first exposure.

- The captured image will be displayed.
- In (1) on the screen, you can check the number of exposures left.
- Pressing the <▶> button enables you to view the captured image (249).

7 Shoot the next exposures.

- Images captured so far are displayed merged. For image-only display, press the <INFO> button repeatedly.
- To view the multiple-exposure image so far, check exposure, and see how the images will be merged, hold down the depth-of-field preview button (or the button assigned to **[Depth-of-field preview]**) in Live View shooting.
- Multiple-exposure shooting will end when the set number of exposures are taken.



- During continuous shooting, the continuous shooting speed will decrease greatly.
- Only the merged multiple-exposure image will be saved. The images taken in steps 6 and 7 for the multiple-exposure image will not be saved.
- The image quality, ISO speed, Picture Style, high ISO speed noise reduction, color space, etc. set for the first single exposure will also be set for the subsequent exposures.
- You cannot set an aspect ratio for multiple-exposure shooting. Images will be taken with a 3:2 aspect ratio.
- If white balance bracketing, Multi Shot Noise Reduction, HDR mode, or a Creative filter is set, multiple-exposure shooting cannot be set.
- During multiple-exposure shooting, the settings of **[📷: Lens aberration correction]**, **[📷: Auto Lighting Optimizer]**, and **[📷: Highlight tone priority]** will be automatically switched to **[Disable]**.
- If **[📷: Picture Style]** is set to **[Auto]**, **[Standard]** will be applied for shooting.
- With multiple exposures, the more exposures there are, the more noticeable the noise, irregular colors, and banding will be.
- If **[Additive]** is set, the image processing after taking the multiple exposures will take time. (The access lamp will light up longer.)
- If you perform Live View shooting with **[Additive]** set, the Live View function will stop automatically when the multiple-exposure shooting ends.
- In step 7, the brightness and noise of the multiple-exposure image displayed during shooting will be different from those of the final multiple-exposure image recorded.
- Multiple-exposure shooting is canceled if you set the power switch to **<OFF>** or switch batteries or cards.
- Multiple-exposure shooting ends if you switch to a Basic Zone mode or to **<C1/C2>**.
- If you connect the camera to a computer, multiple-exposure shooting will not be possible. If you connect the camera to a computer during shooting, multiple-exposure shooting will end.



- The shooting information for the last shot will be recorded and appended to the multiple-exposure image.

Merging Multiple Exposures with a RAW Image Recorded on the Card

You can select a RAW image recorded on the card as the first single exposure. The selected RAW image will remain intact.



1 Select [Select image for multi. expo.].

2 Select the first image.

- Use the <◀> <▶> keys to select the first image, then press <SET>.

- Select [OK].

The file number of the selected image will be displayed at the bottom of the screen.

3 Take the picture.

- When you select the first image, the number of remaining exposures as set with [No. of exposures] will decrease by 1.

- JPEG images cannot be selected.
- These images cannot be selected as the first single exposure: Images captured with [📷: Highlight tone priority] set to [Enable] or [Enhanced], or images captured with [📷: Still img aspect ratio] not set to [3:2].
- [Disable] is applied for [📷: Lens aberration correction] and [📷: Auto Lighting Optimizer] regardless of the settings of the image selected as the first single exposure.
- The ISO speed, Picture Style, high ISO speed noise reduction, color space, etc. set for the first image will also be applied for the subsequent images.
- If Picture Style is [Auto] for the image selected as the first image, [Standard] will be applied for shooting.
- You cannot select an image taken with another camera.
- Images that cannot be merged may be displayed.

- You can also select a RAW image used in multiple-exposure shooting.
- Select [Deselect img] to cancel image selection.

Checking and Deleting Multiple Exposures During Shooting

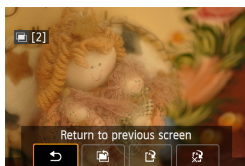

Before you finish shooting your specified number of exposures, you can press the **<▶>** button to view the multiple-exposure image so far, check exposure, and see how the images will be merged.

Pressing the **<🗑>** button will display the operations possible during multiple-exposure shooting.

Operation	Description
↶ Return to previous screen	The screen before you pressed the <🗑> button will reappear.
🗑 Undo last image	Deletes the last image you shot (shoot another image). The number of remaining exposures will increase by 1.
📄 Save and exit	Saves shots up to that point as a multiple-exposure image and exits multiple-exposure shooting.
🗑 Exit without saving	The multiple-exposure shooting will end without saving the image.



- During multiple-exposure shooting, you can only play back multiple-exposure images.

? FAQ

- **Are there any restrictions on the image quality?**

All single exposures and the multiple-exposure image are captured at your specified image quality.

- **Can I merge images recorded on the card?**

With [**Select image for multi. expo.**], you can select the first single exposure from the images recorded on the card (📖 248). Note that you cannot merge multiple images already recorded on the card.

- **Will auto power off take effect during multiple-exposure shooting?**

During multiple-exposure shooting, auto power off will not take effect. Before starting the multiple-exposure shooting, the auto power off will take effect at the time set with the camera, and multiple-exposure settings will be canceled.

HDR (High Dynamic Range) Shooting



You can shoot still photos with clipped highlights and shadows reduced for a high dynamic range of tones even in high-contrast scenes. HDR shooting is effective for landscape and still-life shots.

With HDR shooting, three images of different exposures (standard exposure, underexposure, and overexposure) are captured consecutively for each shot and then merged together automatically. The HDR image is recorded as a JPEG image.

* HDR stands for High Dynamic Range.

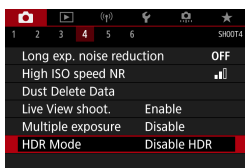

1 Select [: HDR Mode].

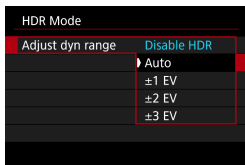

2 Set [Adjust dyn range].

- Selecting [**Auto**] will have the dynamic range set automatically depending on the image's overall tonal range.
- The higher the number, the wider the dynamic range will be.

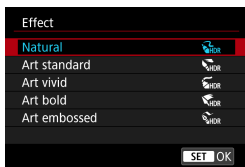

3 Set [Effect].

Effects

-  **Natural**

For images preserving a wide tonal range where the highlight and shadow details would otherwise be lost. Clipped highlights and shadows will be reduced.

-  **Art standard**

While the clipped highlights and shadows will be reduced more than with **[Natural]**, the contrast will be lower, and the gradation flatter to have the picture look like a painting. The subject outlines will have bright (or dark) edges.

-  **Art vivid**

The colors are more saturated than with **[Art standard]**, and the low contrast and flat gradation create a graphic art effect.

-  **Art bold**

The colors are the most saturated, making the subject pop out, and the picture looks like an oil painting.

-  **Art embossed**

The color saturation, brightness, contrast and gradation are decreased to make the picture look flat. The picture looks faded and old. The subject outlines will have bright (or dark) edges.

	Art Standard	Art Vivid	Art Bold	Art Embossed
Saturation	Standard	High	Higher	Low
Outline emphasis	Standard	Weak	Strong	Stronger
Brightness	Standard	Standard	Standard	Dark
Tone	Flat	Flat	Flat	Flatter

-  Each effect will be applied based on the characteristics of the Picture Style currently set (📖 230).

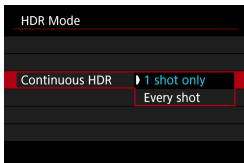

4 Set a [Continuous HDR] option.

- With [**1 shot only**], HDR shooting will be canceled automatically after the shooting ends.
- With [**Every shot**], HDR shooting continues until the setting in step 2 is set to [**Disable HDR**].

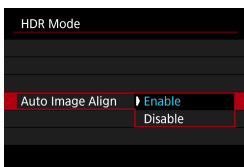

5 Set [Auto Image Align] and shoot.

- For handheld shooting, select [**Enable**]. When using a tripod, select [**Disable**].



- RAW HDR images are captured in JPEG **L** image quality. RAW+JPEG HDR images are captured in the specified JPEG image quality.
- HDR shooting is not possible with expanded ISO speeds (H).
- HDR shooting will automatically have the following set to [**Disable**]: [**Distortion correction**] under [**Lens aberration correction**], [**Auto Lighting Optimizer**], and [**Highlight tone priority**].
- AEB shooting and flash photography are not available.
- If you shoot a moving subject, the moving subject may leave afterimages.
- In HDR shooting, three images are captured with different shutter speeds set automatically. Even in the <Tv> and <M> shooting modes, the shutter speed will be shifted based on the shutter speed you set.
- To prevent camera shake, a high ISO speed may be set.

In Live View Shooting

- Live View effect previews will not look exactly the same as your shots.

- When shooting HDR images with **[Auto Image Align]** set to **[Enable]**, AF point display information (📖 392) and Dust Delete Data (📖 241) will not be appended to the image.
- If you perform handheld HDR shooting with **[Auto Image Align]** set to **[Enable]**, image periphery will be slightly trimmed and resolution will be slightly lowered. Also, if the images cannot be aligned properly due to camera shake, etc., auto image alignment may not take effect. Note that when shooting with excessively bright (or dark) exposure settings, auto image alignment may not work properly.
- If you perform handheld HDR shooting with **[Auto Image Align]** set to **[Disable]**, the three images may not be properly aligned and the HDR effect may be reduced. Using a tripod is recommended.
- Auto image alignment may not function properly with repetitive patterns (lattice, stripes, etc.) or flat, single-tone images.
- The color gradation of the sky or white walls may not be reproduced correctly. Irregular colors, irregular exposure or noise may appear.
- HDR shooting under fluorescent or LED lighting may result in unnatural color reproduction of the illuminated areas.
- With HDR shooting, the images will be merged, then saved to the card, so it may take some time. During the processing of the images, "buSY" will be displayed in the viewfinder and on the LCD panel, and you cannot take another picture until the processing is complete.

Focus Bracketing (Live View Shooting) ☆

Focus bracketing* enables continuous shooting with the focal distance changed automatically after a single shot. From these images, you can create a single image in focus over a wide area by using an application that supports depth compositing, such as Digital Photo Professional (EOS software).

* "Bkt." stands for bracketing.

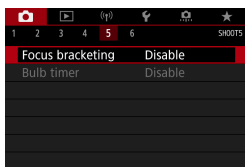

1 Select [CAMERA]: Focus bracketing].

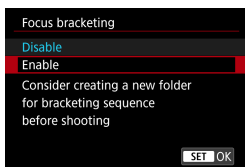

2 Specify [Focus bracketing].

- Select [Enable].



3 Set the number of images.

- Specify the number of images captured per shot.
- Can be set in a range of [2]–[999].

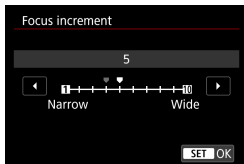

4 Set [Focus increment].

- Specify how much to shift the focus. This amount is automatically adjusted to suit the aperture value at the time of shooting. Because larger aperture values increase the focus shift, focus bracketing covers a wider range under the same **[Focus increment]** and **[Number of shots]** settings in that case.
- After completing the settings, press $\langle \text{SET} \rangle$.

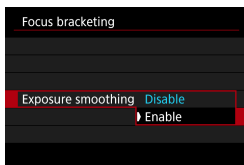

5 Set [Exposure smoothing].

- You can suppress changes in image brightness during focus bracketing by setting **[Exposure smoothing]** to **[Enable]**, which adjusts differences relative to the actual aperture value (effective f/number) that changes with the focal position.

6 Take the picture.

- To save your shots in a new folder, tap $\left[\begin{smallmatrix} \text{M} \\ \text{+} \end{smallmatrix} \right]$ and select **[OK]**.
- Focus at the nearer end of your preferred focal range, then press the shutter button completely.
- Once shooting begins, release the shutter button.
- The camera shoots continuously, shifting the focal position toward infinity.
- Shooting ends after your specified number of images, or at the far end of the focal range.



- Focus bracketing is intended for still photo shooting on a tripod.
- Shooting with a wider angle of view is recommended. After depth compositing, you can crop the image if necessary.
- The following lenses can be used (as of April 2019).
 - EF16-35mm f/4L IS USM
 - EF24-70mm f/4L IS USM
 - EF100mm f/2.8L MACRO IS USM
 - EF180mm f/3.5L MACRO USM
 - EF-S35mm f/2.8 MACRO IS STM
 - EF-S60mm f/2.8 MACRO USM
 - EF-S18-135mm f/3.5-5.6 IS USM
- Set **[Exposure smoothing]** to **[Disable]** with the following lenses, because they may cause changes in image brightness.
 - EF100mm f/2.8 L MACRO IS USM
 - EF180mm f/3.5 L MACRO USM
 - EF-S60mm f/2.8 MACRO USM
- Suitable **[Focus increment]** settings vary by subject. An unsuitable **[Focus increment]** setting may cause unevenness in composite images, or shooting may take more time because more shots are taken. Take some test shots to decide a suitable **[Focus increment]** setting.
- Combining images may take some time when the **[Number of shots]** setting is high.
- Flash photography is not possible.
- Shooting under flickering light may cause uneven images. In this case, lowering the shutter speed may give better results.
- Focus bracketing is not available when the lens's focus mode switch is set to **<MF>**.
- Canceling shooting in progress may cause exposure problems in the last image. Avoid using the last image when combining the images in Digital Photo Professional.



- Use of a tripod, remote switch (sold separately, 156), or wireless remote control (sold separately, 156) is recommended.
- For best results, set the aperture value in a range of f/5.6–11 before shooting.
- Details such as shutter speed, aperture value, and ISO speed are determined by conditions for the first shot.
- To cancel shooting, press the shutter button completely again.
- **[Focus bracketing]** switches to **[Disable]** when the power switch is set to **<OFF>**.

Interval Timer Shooting

With the interval timer in viewfinder shooting, you can set the shooting interval and number of shots to have the camera repeatedly shoot once at the specified interval.

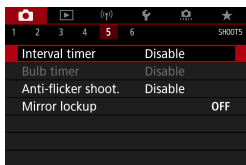

1 Select [: Interval timer].

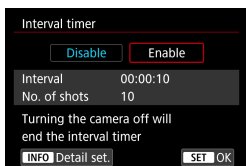

2 Select [**Enable**].

- Select [**Enable**], then press the <INFO> button.

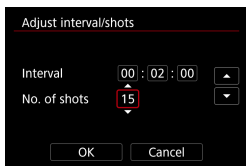

3 Set the shooting interval and number of shots.

- Select an item to set (hours : minutes : seconds / number of shots).
- Press <SET> to display <>.
- Set the desired number, then press <SET>. (Returns to <□>.)

● Interval

Can be set in a range of [00:00:01]–[99:59:59].

● Number of shots

Can be set in a range of [01]–[99]. To keep the interval timer on indefinitely until you stop it, set [00].

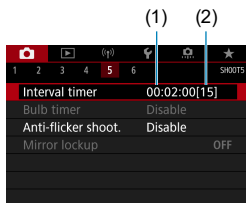

4 Select [OK].

- The interval timer settings will be displayed on the menu screen.

- (1) Interval
(2) Number of shots

5 Take the picture.

- First shot is taken and shooting continues according to the interval timer settings.
- During interval timer shooting, < **TIMER** > will blink on the LCD panel.
- After the set number of shots are taken, the interval timer shooting will stop and be automatically canceled.



- Using a tripod is recommended.
- Taking test shots in advance is recommended.
- Even during interval timer shooting, you can still shoot as usual by pressing the shutter button completely. Note that the camera will prepare for the next interval timer shot approx. 5 sec. in advance, which will temporarily prevent operations such as adjusting shooting settings, accessing menus, and playing back images.
- If the next scheduled interval timer shot is not possible because the camera is shooting or processing images, it will be skipped.
- Even during interval timer operation, auto power off is triggered after approx. 8 sec. of inactivity, as long as [**☿: Auto power off**] is not set to [**Disable**]. The camera will automatically turn on again approx. 1 min. before the next shot.
- Can also be combined with AEB, white balance bracketing, multiple exposures, and HDR mode.
- To stop interval timer shooting, set the power switch to <OFF>.



- Do not point the camera toward an intense light source, such as the sun or an intense artificial light source. Doing so may damage the image sensor or the camera's internal components.
- Setting the lens focus mode switch to <AF> prevents the camera from shooting unless subjects are in focus. Setting it to <MF> and focusing manually before shooting is recommended.
- If the shooting time is long, using the household power outlet accessories (sold separately) is recommended.
- Shooting long exposures or using shutter speeds longer than the shooting interval will prevent shooting at the specified interval. For this reason, fewer shots than specified will be taken. Using shutter speeds nearly the same as the shooting interval may also reduce the number of shots.
- If the time it takes to record to the card exceeds the shooting interval due to the shooting functions set or card performance, some of the shots may not be taken with the set intervals.
- When using flash with interval timer shooting, set an interval longer than the flash charge time. Intervals that are too short may prevent the flash from firing.
- Intervals that are too short may prevent shooting or autofocusing.
- Interval timer shooting will be canceled and reset to **[Disable]** if you set the power switch to <OFF>, set the shooting mode to or <G/□>, or use EOS Utility (EOS software).
- During interval timer shooting, you cannot use remote control shooting (📖 155) or remote-release shooting with a Speedlite.



Flicker Effect Reduction

If you shoot an image with a fast shutter speed under a light source such as fluorescent light, the blinking of the light source causes flicker and the image may be vertically unevenly exposed. If continuous shooting is used under these conditions, uneven exposures or colors across the images may result. Anti-flicker shooting enables viewfinder shooting at moments when exposure and colors are less affected by flickering.

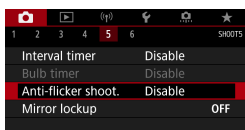

1 Select [: Anti-flicker shoot.].

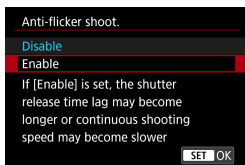

2 Select [Enable].

3 Take the picture.



- When [Enable] is set and you shoot under a flickering light source, the shutter-release time lag may become longer. Also, the continuous shooting speed may become slower, and the shooting interval may become irregular.
- Not applied to mirror lockup shots, Live View shooting, or movie recording.
- Flicker at a frequency other than 100 Hz or 120 Hz cannot be detected. Also, if the flickering frequency of the light source changes during continuous shooting, effects of the flicker cannot be reduced.



- In the <P> or <Av> mode, if the shutter speed changes during continuous shooting or if you shoot multiple shots of the same scene at different shutter speeds, the color tone may become inconsistent. To avoid inconsistent color tones, use the <M> or <Tv> mode at a fixed shutter speed.
- Color tone of captured images may vary between [Enable] and [Disable].
- Shutter speed, aperture value, and ISO speed may change when you start shooting with AE lock.
- If the subject is against a dark background or if there is a bright light in the image, flicker may not be properly detected.
- Flicker reduction may not be possible under special lighting.
- Depending on the light source, flicker may not be detected properly.
- Depending on the light sources or shooting conditions, the expected result may not be obtained even if you use this function.



- Taking test shots in advance is recommended.
- When you shoot with flicker reduction, <Flicker!> will light up. If <Flicker!> does not appear in the viewfinder, set [Flicker detection] in [Viewfinder display] to [Show] (p. 536). Under a light source that does not flicker or with no flicker detected, <Flicker!> will not be displayed.
- Even if you set [Ⓜ: Anti-flicker shoot.] to [Disable], with [Flicker detection] set to [Show], <Flicker!> in the viewfinder will blink to warn you if the camera meters under a flickering light source.
- Although <Flicker!> is not displayed in Basic Zone modes, the effects of flickering are still reduced when you shoot.
- The expected result may not be obtained for wireless flash photography.

Mirror Lockup

Mirror lockup keeps the mirror up in viewfinder shooting to reduce blur from mirror movement. Useful when shooting close-ups (macro photography), using a super telephoto lens, shooting at slow shutter speeds, etc.

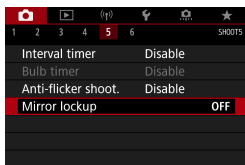

1 Select [: Mirror lockup].

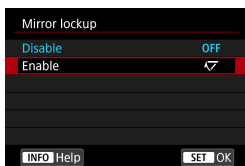

2 Select [Enable].

3 Focus on the subject, then press the shutter button completely.

- The mirror will swing up.

4 Press the shutter button completely again.

- The picture is taken and the mirror goes back down.

- 
- Do not point the camera toward an intense light source, such as the sun or an intense artificial light source. Doing so may damage the image sensor or the camera's internal components.
 - In very bright light, such as at the beach or a ski slope on a sunny day, take the picture promptly after mirror lockup is stabilized.
 - During mirror lockup, shooting function settings and menu operations are disabled.

- 
- Single shooting drive mode is used when this function is enabled.
 - You can also use the self-timer with mirror lockup.
 - If approx. 30 sec. elapse after the mirror has locked up, it will go back down automatically. Pressing the shutter button completely locks up the mirror again.
 - Consider using a tripod and remote controller (Remote Switch RS-60E3, Remote Controller RC-6, or Wireless Remote Control BR-E1, all sold separately).

Continuous AF (Live View Shooting)

This function keeps subjects generally in focus in Live View shooting. The camera is ready to focus immediately when you press the shutter button halfway.

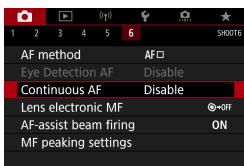

1 Select []: Continuous AF].

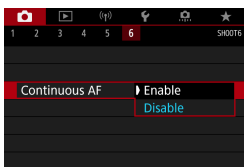

2 Select [Enable].



- Enabling this function reduces the number of shots available, because the lens is driven continuously and battery power is consumed.

Lens Electronic MF Settings



For EF, or EF-S lenses equipped with electronic manual focusing, you can specify how manual focus adjustment is used with One-Shot AF.

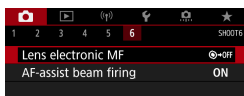

1 Select [: Lens electronic MF].

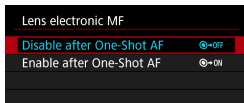

2 Select an item.

● Disable after One-Shot AF

Manual focus adjustment after the AF operation is disabled.

● Enable after One-Shot AF

You can manually adjust the focus after the AF operation if you keep holding down the shutter button halfway.



- For details on your lens's manual focus specifications, refer to the lens instruction manual.

AF-Assist Beam Settings

You can specify to use the AF-assist beam of the built-in flash or a Speedlite in viewfinder shooting.



1 Select []: AF-assist beam firing].

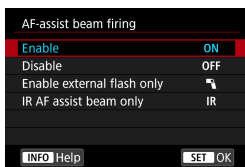

2 Select an item.

- **[ON] Enable**

Enables firing of the AF-assist beam, when needed.

Press the < > button to fire the AF-assist beam from the built-in flash.

- **[OFF] Disable**

Disables firing of the AF-assist beam. Set if you prefer not to fire the AF-assist beam.

- **[] Enable external flash only**

Enables firing of the AF-assist beam when needed, only when external Speedlites are used.

- **[IR] IR AF assist beam only**

Enables infrared AF-assist beam firing by external Speedlites equipped with this feature, when these flash units are attached.



- If an external Speedlite's **[AF-assist beam firing]** Custom Function is set to **[Disable]**, the AF-assist beam will not be emitted.



- The AF-assist beam of an attached EX series Speedlite equipped with an LED light will fire as needed from the Speedlite's LED light in Live View shooting when you specify **[Enable]** or **[Enable external flash only]**.

General Still Photo Shooting Cautions

Applies to Both Viewfinder and Live View Shooting



Image Quality

- When you shoot at high ISO speeds, noise (such as dots of light and banding) may become noticeable.
- Shooting in high temperatures may cause noise and irregular colors in the image.

With Live View shooting



- Do not point the camera toward an intense light source, such as the sun or an intense artificial light source. Doing so may damage the image sensor or the camera's internal components.

Image Quality

- Frequent shooting over an extended period may cause the camera's internal temperature to rise and affect image quality. When you are not shooting, always turn off the camera.
- If you shoot a long exposure while the camera's internal temperature is high, image quality may decline. Stop shooting and wait a few minutes before shooting again.

White [🔴] and Red [🔴] Icons

- If the camera's internal temperature rises from extended shooting or use in hot environments, a white [🔴] or red [🔴] icon will appear.
- The white [🔴] icon indicates that the image quality of still photos will decline. Stop shooting for a while and allow the camera to cool down.
- Shooting at low ISO speeds instead of high speeds is recommended when a white [🔴] icon is displayed.
- The red [🔴] icon indicates that shooting will soon end automatically. Shooting will not be possible again until the camera cools down internally, so stop shooting temporarily or turn off the camera and let it cool down a while.
- Shooting in hot environments over extended periods will cause the white [🔴] or red [🔴] icon to appear sooner. When you are not shooting, always turn off the camera.
- If the camera's internal temperature is high, the quality of images shot with a high ISO speed or long exposure may decline even before the white [🔴] icon is displayed.

Shooting Results

- In magnified view, the shutter speed and aperture will be displayed in red. If you take the picture in magnified view, the exposure may not come out as desired. Return to the normal view before taking the picture.
- Even if you take the picture in magnified view, the image will be captured with the image area of the normal view.



Images and Display

- Under low- or bright-light conditions, the displayed image may not reflect the brightness of the captured image.
- Under low light, noise may be noticeable in image display even at low ISO speeds, but there will be less noise in your shots, because image quality varies between display and captured images.
- The screen or exposure value may flicker if the light source (lighting) changes. In this case, stop shooting temporarily and resume under the light source you will use.
- Pointing the camera at different direction may momentarily prevent correct display of brightness. Wait until the brightness level stabilizes before shooting.
- If there is a very bright light source in the image, the bright area may appear black on the screen. However, the actual captured image will correctly show the bright area.
- In low light, if you set the [**☞**: **Disp. brightness**] to a bright setting, noise or irregular colors may appear in the image. However, the noise or irregular colors will not be recorded in the captured image.
- When you magnify the image, the image sharpness may look more pronounced than in the actual image.

Custom Functions

- Some Custom Functions are not available (some settings have no effect).

Lens and Flash

- If the attached lens has an Image Stabilizer and you set the Image Stabilizer (IS) switch to <ON>, the Image Stabilizer will operate at all times even if you do not press the shutter button halfway. The Image Stabilizer consumes battery power and may decrease the number of possible shots depending on the shooting conditions. When the Image Stabilizer is not necessary, such as when using a tripod, it is recommended that you set the IS switch to <OFF>.
- With EF lenses, focus preset during shooting is only available when using (super) telephoto lenses equipped with this function released in and after the second half of 2011.
- FE lock is not available with the built-in flash. FE lock and modeling flash will not work if an external Speedlite is used.



- With the HDMI Cable HTC-100 (sold separately), you can display the image on a television (📖 344). Note that no sound will be output.

Information Display in Live View Shooting

For details on the icons displayed for still photo shooting, see 📖 623.



- When [Exp.SIM] is displayed in white, it indicates that the image is displayed at the brightness level closely matching that of the actual image to be captured.
- If [Exp.SIM] is blinking, it indicates that the image is displayed at a brightness that differs from the actual shooting result because of low- or bright-light conditions. However, the actual image recorded will reflect the exposure setting. Note that the noise may be more noticeable than the actual image recorded.
- Exposure simulation may not be performed under some shooting settings. The [Exp.SIM] icon and histogram will be displayed in gray. The image will be displayed on the screen at the standard brightness. The histogram may not be properly displayed in low- or bright-light conditions.
- The histogram can be displayed when [📷: Expo. simulation] is set to [Enable] (📖 221).



Movie Recording

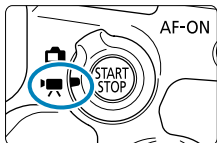

For movie recording, set the Live View shooting/ Movie shooting switch to <[movie camera icon]>.

- A ☆ icon to the right of a page title indicates that the function is available only in Creative Zone.
- When switching from still photo shooting to movie recording, check the camera settings again before recording movies.

Tab Menus: Movie Recording

● Shooting 1

SHOOT1		
Movie rec quality	FHD 29.97P IPB	288
Sound recording	Auto	295
Movie digital IS	Disable	298
Lens aberration correction		322
Time-lapse movie	Disable	300
Remote control	Disable	322
Video snapshot	Disable	312

● Shooting 2

SHOOT2		
Exposure comp.	-3..2..1..0..1..2..3	211
ISO speed settings		322
Auto Lighting Optimizer		218
Highlight tone priority	OFF	323
Auto slow shutter	A-SLOW OR	324
Metering timer	8 sec.	220

● Shooting 3

SHOOT3		
White balance	AWB	224
Custom White Balance		225
WB correction	0,0	227
Picture Style	Auto	230
High ISO speed NR		238
HDMI info disp	ON	325

● Shooting 4

Menu Item	Page Number
AF method	135
Movie Servo AF	317
Eye Detection AF	142
Lens electronic MF	266
Movie Servo AF track sens.	319
Movie Servo AF speed	320
MF peaking settings	149

In **Basic Zone** modes, the following screens are displayed.
Note that available setting items vary by shooting mode.

● Shooting 1

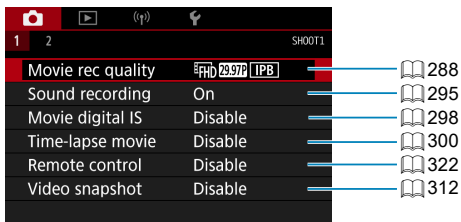

● Shooting 2

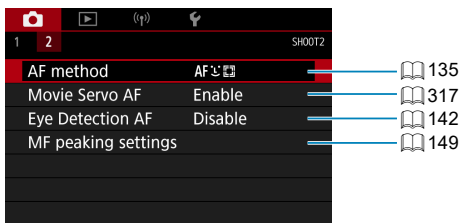



Movie Recording

Autoexposure Recording

Autoexposure control will take effect to suit the scene's current brightness.

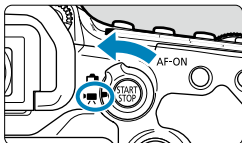



1 Set the Mode dial to a mode other than <SCN>, <>, or <M>.

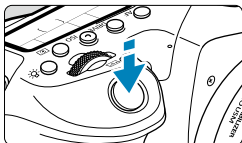

2 Set the Live View shooting/Movie shooting switch to <>.





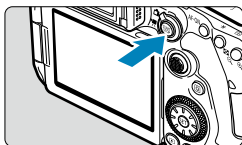

3 Focus on the subject.

- Before recording a movie, focus with AF or manual focus ( 135,  147).
- By default, [: Movie Servo AF] is set to [Enable] so that the camera always keeps focusing ( 317).
- When you press the shutter button halfway, the camera will focus with the current AF method.



4 Record the movie.

- Press the < > button to start recording a movie.
- While the movie is being recorded, the “ REC” mark will be displayed on the upper right of the screen.
- Sound is recorded by the built-in microphone ( 31).
- To stop recording the movie, press the < > button again.



ISO Speed in Basic Zone Modes

- The ISO speed will be set automatically within ISO 100–12800.

ISO Speed in the <P>, <Tv>, <Av>, and Modes

- Will be set according to the details of [📷: 📖ISO speed settings] (📖 322).



- When the <SCN> mode is set, HDR movie recording takes effect (📖 284).
- Even if you set the <Tv> or <Av> mode, movie recording with priority given to shutter speed or aperture cannot be performed. Autoexposure recording takes effect as in the <P> mode.
- Regarding the ISO speed for time-lapse movie recording, see 📖 322.



- Recording in Basic Zone modes produces the same results as for <A+> mode. In the <A+> mode, the scene icon detected by the camera is displayed in the upper left of the screen (📖 627).
- In Creative Zone modes, you can press the <✳> button (📖 161) to lock the exposure (AE lock). After applying AE lock during movie recording, you can cancel it by pressing the <📷> button. (AE lock setting is retained until you press the <📷> button.)
- Exposure compensation in Creative Zone modes can be set in a range of up to ±3 stops.
- ISO speed, shutter speed, and aperture are not recorded in movie Exif information.
- With autoexposure movie recording (except in time-lapse movie recording), this camera supports the Speedlite's function to turn on the LED light automatically in low-light conditions. For details, refer to the Instruction Manual of the EX-series Speedlite equipped with an LED light.

Manual Exposure Recording

You can manually set the shutter speed, aperture, and ISO speed for movie recording.

1 Set the Live View shooting/Movie shooting switch to .

2 Set the Mode dial to **M**.



3 Set the ISO speed.



- Press the **<ISO>** button.

The ISO speed setting appears on the screen.

- Set with the  or  dial.



4 Set the shutter speed and aperture.

- Press the shutter button halfway and check the exposure level indicator.
- To set the shutter speed (1), turn the  dial. To set the aperture (2), turn the  dial.

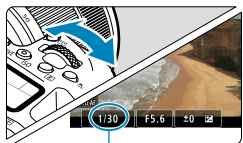

(1)

5 Focus and record the movie.

- The procedure is the same as steps 3 and 4 for “Autoexposure Recording” ( 277).

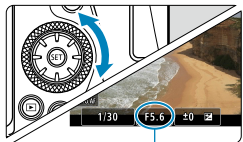

(2)

- During movie recording, avoid changing the shutter speed, aperture, or ISO speed. Doing so may record the changes in the exposure or create more noise at high ISO speeds.
- When recording a movie of a moving subject, a shutter speed of approx. 1/25 sec. to 1/125 sec. is recommended. The faster the shutter speed, the less smooth the subject's movement will look.
- If you change the shutter speed while recording under fluorescent or LED lighting, image flicker may be recorded.

- With ISO Auto, exposure compensation can be set in a range of ± 3 stops.
- When ISO Auto is set, you can press the **<★>** button to lock the ISO speed. After locking the ISO speed during movie recording, you can cancel it by pressing the **<☒>** button. (ISO speed lock is maintained until you press the **<☒>** button.)
- If you press the **<★>** button and recompose the shot, you can see the exposure level difference on the exposure level indicator compared to when the **<★>** button was pressed.
- With the camera ready to shoot in the **<M>** mode, you can display the histogram by pressing the **<INFO>** button.

ISO Speed in **<M>** Mode

You can set the ISO speed manually or select **[AUTO]**. For details on the ISO speed, see  620.

Available Shutter Speeds

Shutter speed in <M> mode can be set in a range of 1/4000–1/8 sec.



- The available shutter speeds will differ for time-lapse movie recording (📖 300).

Still Photo Shooting

Still photos cannot be taken during movie recording. To take still photos, stop the movie recording and perform viewfinder shooting or Live View shooting.

Information Display (Movie Recording)

For details on the icons displayed for movie recording, see 📖 625.





Cautions for Movie Recording

- Do not point the camera toward an intense light source, such as the sun or an intense artificial light source. Doing so may damage the image sensor or the camera's internal components.
- If you shoot something that has fine detail, moire or false colors may result.
- If [AWB] or [AWB w] is set and the ISO speed or aperture changes during movie recording, the white balance may also change.
- If you record a movie under fluorescent or LED lighting, the movie image may flicker.
- If you perform AF with a USM lens during movie recording in low light, horizontal banding noise may be recorded in the movie. The same type of noise may occur if you focus manually with certain lenses equipped with an electronic focusing ring.
- Recording a few test movies is recommended if you intend to perform zooming during movie recording. Zooming as you record movies may cause exposure changes or lens sounds to be recorded, an uneven audio level, or loss of focus.
- Large aperture values may delay or prevent accurate focusing.
- When you press the shutter button halfway to perform AF during movie recording, any of the following may occur: The focus is temporarily greatly thrown off, changes in movie brightness is recorded, the movie recording stops momentarily, and the mechanical sound of the lens is recorded.
- Avoid covering the built-in microphones (📖 277) with your fingers or other objects.
- "General Movie Recording Cautions" are on 📖 326–📖 327.
- If necessary, also read "General Still Photo Shooting Cautions" on 📖 269–📖 271.



Notes for Movie Recording

- Each time you record a movie, a new movie file is created on the card.
- The movie's field of view coverage for recording 4K, Full HD, and HD movies is approx. 100%.
- To enable starting or stopping movie recording by pressing the shutter button completely, set **[Fully-press]** for **[: Shutter btn function for movies]** to **[Start/stop mov rec]**.
- Stereo sound is recorded by the camera's built-in microphone ( 277).
- Any external microphones such as Directional Stereo Microphone DM-E1 (sold separately) connected to the camera's external microphone IN terminal are used instead of the built-in microphones ( 296).
- Most external microphones equipped with a 3.5 mm diameter mini plug can be used.
- With EF lenses, focus preset during movie recording is available when using (super) telephoto lenses equipped with this function released in and after the second half of 2011.
- YCbCr 4:2:0 (8-bit) color sampling and the Rec. ITU-R BT.709 color space are used for 4K, Full HD, and HD movies.

HDR Movie Recording

You can shoot high dynamic range movies that retain detail in highlights of high-contrast scenes.



1 Set the Mode dial to <SCN>.



2 Record an HDR movie.

- Record the movie in the same way as normal movie recording.

! ● Since multiple frames are merged to create an HDR movie, certain parts of the movie may look distorted. This is more noticeable in shots affected by camera shake, so consider using a tripod. Note that even if a tripod is used for recording, afterimages or noise may become more noticeable when the HDR movie is played back frame-by-frame or in slow-motion compared to normal playback.

-  ● The recording size is $\overline{\text{FHD}}$ $\overline{29.97\text{P}}$ $\overline{\text{IPB}}$ (NTSC) or $\overline{\text{FHD}}$ $\overline{25.00\text{P}}$ $\overline{\text{IPB}}$ (PAL).
● ISO speed is set automatically when you record HDR movies.

Movie Recording With Filter Effects Applied

In **<Q>** (creative filters) mode, you can record movies with filter effects applied.



1 Set the Mode dial to **<Q>**.

2 Press the **<Q>** button (10).

- The Quick Control screen will appear.

3 Select [**SHOOTING MODE**].

- Use the **<▲>** **<▼>** keys to select [**SHOOTING MODE**] (Shooting mode) in the upper left, then press **<SET>**.

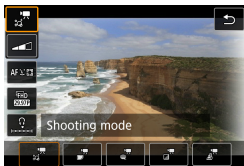

4 Select a filter effect.

- Use the **<▲>** **<▼>** keys to select a filter effect (286–287), then press **<SET>**.
- The image is shown with the filter effect applied.
- For Miniature effect movie, move the AF point to the position to focus on. Move the scene frame if the AF point is outside of it, so that the AF point is aligned with it.

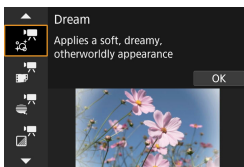

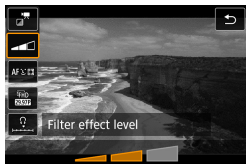

5 Adjust the filter effect level.

- Press the <[Q]> button to select the icon below **[Shooting mode]**.
- Use the <◀> <▶> keys to adjust the effect, then press <SET>.
- When setting up miniature effect movies, select the playback speed.

6 Record the movie.

- A magnified view is not available.
- No histogram is displayed.
- Not available for video snapshots, time-lapse movies, or Movie digital IS.

- In Creative Zone modes, Creative filter settings are available from the Quick Control screen (103).

Creative Filter Characteristics

● **Dream**

Applies a soft, dreamy, otherworldly appearance. Gives the movie a soft look overall, blurring the periphery of the screen. You can adjust the blurry areas along the screen edges.

● **Old Movies**

Creates an atmosphere like an old film by adding wavering, scratches, and flickering effects to the image. The top and bottom of the screen are masked in black. You can modify the wavering and scratch effects by adjusting the filter effect.



● **Memory**

Creates the atmosphere of a distant memory. Gives the movie a soft look overall, reducing brightness of the periphery of the screen. You can modify the overall saturation and the dark areas along the screen edges by adjusting the filter effect.

● Dramatic B&W

Creates an atmosphere of dramatic realism with high-contrast black and white. You can adjust the graininess and black-and-white effect.

● Miniature effect movie

You can record movies with a miniature (diorama) effect. Select the playback speed and shoot. To make the scene frame movable, press the <Q> button in step 4 (or tap [] in the lower right of the screen), and after it turns orange, move it with the <▲> <▼> keys. To center the frame again, press the <INFO> button. To switch between vertical and horizontal scene frame orientation, tap [] in the lower left of the screen. Press <SET> to confirm the position of the scene frame. In step 5, set the playback speed to [5x], [10x], or [20x] before recording. Live 1-point AF is used as the AF method, focusing on subjects centered in the white frame. The white frame is hidden during recording.

Speed and playback time (for a 1-minute movie)

Speed	Playback Time
5x	Approx. 12 sec.
10x	Approx. 6 sec.
20x	Approx. 3 sec.



- The color gradation of the sky or white walls may not be reproduced correctly. Irregular colors, irregular exposure or noise may appear.

[] (Miniature Effect Movies)

- Sound is not recorded.
- Movie Servo AF will not function.
- Editing is not available for movies with a playback time less than 1 sec. ( 338).

Movie Recording Quality Settings



Under the [**📷**: **Movie rec quality**] tab, set the image size, frame rate, and compression method. The movie will be recorded as an MP4 file.

The frame rate displayed on the [**Movie rec. size**] screen switches automatically depending on the [**📷**: **Video system**] setting (📖 520).

- 🗨️ The card's writing and reading speeds required for recording movies (card performance requirements) vary depending on the movie recording size. Before recording movies, see 📖 617 to check the performance requirements of the card.

Image Size

- [**4K**] **3840×2160**
The movie is recorded in 4K quality. The aspect ratio is 16:9.
- [**FHD**] **1920×1080**
The movie will be recorded in Full-High-Definition (Full HD) quality. The aspect ratio is 16:9.
- [**HD**] **1280×720**
The movie is recorded in High-Definition (HD) quality. The aspect ratio is 16:9.



- If you change the [📷: Video system] setting, also set [📷: Movie rec. size] again.
- Normal playback of 4K and 4K FHD 59.94P / 50.00P movies may not be possible on other devices, because playback is processing-intensive.
- Clarity and noise vary depending on movie recording quality and cropped shooting settings.



- Movies cannot be recorded in VGA quality.

4K Movie Recording

- Recording 4K movies requires a high-performance card. For details, see “Cards that Can Record Movies” on 617.
- Recording 4K movies greatly increases the processing load, which may cause the camera’s internal temperature to increase faster or become higher than for regular movies. **If a red 🚫 icon or [⚠️] appears during movie recording, the card may be hot, so stop recording the movie and let the camera cool down before removing the card. (Do not remove the card immediately.)**
- From a 4K movie, you can select any frame to save as an approx. 8.3 megapixel (3840×2160) JPEG still image to the card (342).
- With [4K movie cropping] set to [Enable], you can record movies cropped around the center of the screen, as if shot using a telephoto lens. Note that time-lapse movies are not recorded cropped even when [Enable] is set.



Recording coverage

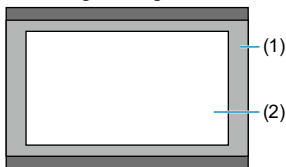

- (1) [Disable]
(2) [Enable]

Frame Rate (fps: frame per second)

- **[59.94P] 59.94fps / [29.97P] 29.97fps / [23.98P] 23.98fps**

For areas where the TV system is NTSC (North America, Japan, South Korea, Mexico, etc.).

- **[50.00P] 50.00fps / [25.00P] 25.00fps**

For areas where the TV system is PAL (Europe, Russia, China, Australia, etc.).

Compression Method

- **[IPB] IPB (Standard)**

Compresses multiple frames at a time efficiently for recording.

- **[IPB] IPB (Light)**

Since the movie is recorded at a bit rate lower than with IPB (Standard), the file size will be smaller than with IPB (Standard) and the playback compatibility will be higher. This will make the possible recording time longer than with IPB (Standard) (with a card having the same capacity).



Movie Recording Format

- **[MP4] MP4**

All movies you shoot with the camera are recorded as movie files in MP4 format (file extension “.MP4”).

Cards that Can Record Movies

For details on cards you can use for various movie recording sizes, see  617.

When recording movies, use a high-capacity card with a writing/reading speed (as specified in card performance requirements) shown in the table on  617 or higher than the standard specification. **Test cards by recording a few movies to make sure they can record correctly at your specified size** ( 288).



- Format cards before recording 4K movies ( 511).
- If you use a slow-writing card when recording movies, the movie may not be recorded properly. Also, if you play back a movie on a card with a slow reading speed, the movie may not be played back properly.
- When recording movies, use high-performance cards with a writing speed sufficiently higher than the bit rate.
- When movies cannot be recorded normally, format the card and try again. If formatting the card does not resolve the problem, refer to the card manufacturer's website, etc.



- To obtain better performance with the card, formatting the card with the camera before recording movies is recommended ( 511).
- To check the card's writing/reading speed, refer to the card manufacturer's website, etc.

High Frame Rate

You can record Full HD movies at a high frame rate of 119.88 fps or 100.0 fps. This is ideal for recording movies that will be played back in slow motion. The maximum recording time per movie is 7 min. 29 sec.

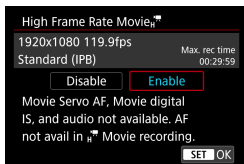

Movies are recorded as **FHD 119.9P [IPB]** or **FHD 100.0P [IPB]**. They are recorded cropped around the center of the shooting screen. Movie Servo AF and Movie digital IS have no effect when recording High Frame Rate movies. AF is not used to focus.



(1) (2)

- (1) Full HD recording
- (2) High Frame Rate recording

Because High Frame Rate movies are recorded as 29.97 fps/25.00 fps movie files, they are played back in slow motion at 1/4 speed.

- Check the **[Movie rec. size]** setting if you return this setting to **[Disable]**.
- The screen may flicker if you record High Frame Rate movies under fluorescent or LED lighting.
- For a moment when you start or stop recording High Frame Rate movies, the movie is not updated, and the frame stops momentarily. Be aware of this when recording movies to external devices via HDMI.
- Movie frame rates shown on the screen as you record High Frame Rate movies do not correspond to the frame rate of the movie recorded.
- Sound is not recorded.

Movie Files Exceeding 4 GB

Even if you record a movie exceeding 4 GB, you can keep recording without interruption.

● Using SD/SDHC cards formatted with the camera

If you use the camera to format an SD/SDHC card, the camera will format it in FAT32.

With a FAT32-formatted card, if you record a movie and the file size exceeds 4 GB, a new movie file will be created automatically.

When you play back the movie, you will have to play back each movie file individually. Movie files cannot be played back automatically in consecutive order. After the movie playback ends, select the next movie and play it back.

● Using SDXC cards formatted with the camera

If you use the camera to format an SDXC card, the camera will format it in exFAT.

When using an exFAT-formatted card, even if the file size exceeds 4 GB during movie recording, the movie will be saved as a single file (rather than being split into multiple files).



- When importing movie files exceeding 4 GB to a computer, use either EOS Utility or a card reader (📖 593). It may not be possible to save movie files exceeding 4 GB if you attempt this using standard features of the computer's operating system.

Total Movie Recording Time and File Size Per Minute

For details on file sizes and the recording time available at each movie recording size, see  618.

Movie Recording Time Limit

- **When recording non-High Frame Rate movies**

The maximum recording time per movie is 29 min. 59 sec. Once 29 min. 59 sec. is reached, recording automatically stops. You can start recording a movie again by pressing the movie shooting button (which records the movie as a new file).

- **When recording High Frame Rate movies**

The maximum recording time per movie is 7 min. 29 sec. Once 7 min. 29 sec. is reached, recording automatically stops. You can start recording a High Frame Rate movie again by pressing the movie shooting button (which records the movie as a new file).

Setting the Sound Recording

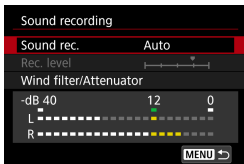

You can record movies while recording sound with the built-in stereo microphone or an external stereo microphone. You can also freely adjust the sound-recording level. Use [**📷**: **Sound recording**] to set sound recording functions.

Sound Recording/Sound-Recording Level

● Auto

The sound-recording level is adjusted automatically. Auto level control will take effect automatically in response to the sound level.

● Manual

You can adjust the sound-recording level as needed.

Select [**Rec. level**] and press the <<> <>> keys while looking at the level meter to adjust the sound-recording level. Look at the peak hold indicator, and adjust so that the level meter sometimes lights up on the right of the "12" (-12 dB) mark for the loudest sounds. If it exceeds "0", the sound will be distorted.

● Disable

Sound will not be recorded.

Wind Filter

Set to [**Auto**] to reduce wind noise automatically when there is wind outdoors. Only activated when the camera's built-in microphone is used. When the wind filter function takes effect, part of the low bass sounds will also be reduced.

Attenuator

Automatically suppresses sound distortion caused by loud noises. Set **[Sound rec.]** to **[Enable]** if distortion occurs when set to **[Auto]** or **[Manual]**.

External Microphone

If an external microphone equipped with a miniature stereo plug (3.5 mm diameter) is connected to the camera's external microphone IN terminal, the external microphone will be given the priority. Using the Directional Stereo Microphone DM-E1 (sold separately) is recommended.

Headphones

By connecting commercially available headphones with a 3.5 mm mini plug to the headphone terminal, you can listen to the sound as movies are recorded or played back. To adjust headphone volume, access **[🔊: Headphone volume]** (📖 523), or press the **<[Q]>** button, select **[🔊]**, then adjust with the **<◀>** **<▶>** keys.



- Sounds from Wi-Fi operations may be captured with built-in or external microphones. During sound recording, using the wireless communication function is not recommended.
- When connecting an external microphone or headphones to the camera, make sure the plug is fully inserted.
- The camera's built-in microphone will also record the operation sound and mechanical sound of the camera during shooting. Using Directional Stereo Microphone DM-E1 (sold separately) may reduce such sounds in the movie.
- Do not connect anything other than an external microphone to the camera's external microphone IN terminal.
- Because noise reduction is not applied to audio played through headphones, it will sound different from the audio recorded with movies.
- Do not change the **[Sound recording]** settings when listening with headphones. This may cause sudden loud output that may hurt your ears.



- In Basic Zone modes, the settings available for **[Sound recording]** are **[On]** or **[Off]**. Set to **[On]** for automatic adjustment of the recording level.
- Audio is also output when the camera is connected to televisions via HDMI, except when **[Sound rec.]** is set to **[Disable]**.
- The sound volume balance between L (left) and R (right) cannot be adjusted.
- Sound is recorded at a 48 kHz/16-bit sampling rate.

Movie Digital IS

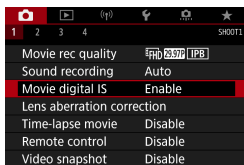

The camera's Movie digital IS feature reduces camera shake as movies are recorded. Movie digital IS can provide effective stabilization even when your lens is not equipped with Image Stabilizer. When using a lens equipped with Image Stabilizer, set the lens's Image Stabilizer switch to <ON>.

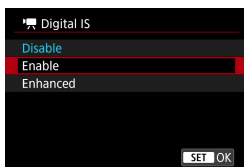

1 Select []: **Movie digital IS**].



2 Select an item.

- **Disable** ()
Image stabilization with Movie digital IS is disabled.
- **Enable** ()
Camera shake will be corrected. The image will be slightly magnified.
- **Enhanced** ()
Compared to when [**Enable**] is set, stronger camera shake can be corrected. The image will be more magnified.



- Movie digital IS will not function when the lens's optical Image Stabilizer switch is set to <OFF>.
- With a lens whose focal length is longer than 800 mm, Movie digital IS will not function.
- Movie digital IS cannot be set in <SCN> or <☉> mode or when High Frame Rate, time-lapse movie, or Creative filter is set.
- The wider the angle of view, the more effective the image stabilization will be. The narrower the angle of view, the less effective the image stabilization will be.
- When using a TS-E lens, fish-eye lens, or non-Canon lens, setting Movie digital IS to **[Disable]** is recommended.
- Effects of Movie digital IS are not applied to images during magnified display.
- Since Movie digital IS magnifies the image, the image looks more grainy. Noise, dots of light, etc. may also become noticeable.
- Depending on the subject and shooting conditions, the subject may blur noticeably (the subject momentarily looks out of focus) due to the effects of the Movie digital IS.
- When Movie digital IS is set, the size of AF points will also change.
- When using a tripod, setting Movie digital IS to **[Disable]** is recommended.

Recording Time-lapse Movies

Still photos shot at a set interval can be stitched together automatically to create a 4K or Full HD time-lapse movie. A time-lapse movie shows how a subject changes in a much shorter period of time than the actual time it took. It is effective for a fixed-point observation of changing scenery, growing plants, celestial motion, etc.

Time-lapse movies will be recorded in MP4 format at the following quality: $\text{4K } 29.97\text{P } \text{ALL-I}$ (NTSC)/ $\text{4K } 25.00\text{P } \text{ALL-I}$ (PAL) for 4K shooting, and $\text{FHD } 29.97\text{P } \text{ALL-I}$ (NTSC)/ $\text{FHD } 25.00\text{P } \text{ALL-I}$ (PAL) for Full HD shooting.

Note that the frame rate will be switched automatically according to the [👉: Video system] setting (📖 520).

1 Select a shooting mode.

- Autoexposure recording is used in $\langle \text{A}^+ \rangle$, $\langle \text{P} \rangle$, $\langle \text{Tv} \rangle$, $\langle \text{Av} \rangle$, or $\langle \text{B} \rangle$ mode.
- Manual exposure recording is used in $\langle \text{M} \rangle$ mode.

2 Set the Live View shooting/Movie shooting switch to $\langle \text{📷} \rangle$.

3 Select [📷: Time-lapse movie].

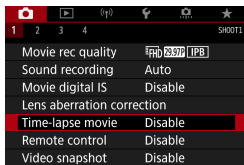

4 Select [Time-lapse].

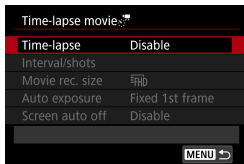

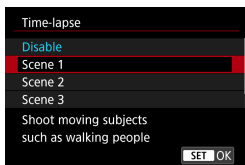

5 Select a scene.

- Select a scene to suit the shooting situation.
- For greater freedom when setting the shooting interval and number of shots manually, select **[Custom]**.

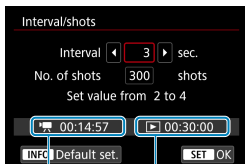

(1)

(2)

6 Set the shooting interval.

- Select **[Interval/shots]**.
- Select **[Interval]** (sec.). Use the <◀> <▶> keys to set a value, then press <SET>.
- Refer to **[🕒: Time required]** (1) and **[🕒: Playback time]** (2) to set the number.

When **[Custom]** is set

- Select **[Interval]** (min.:sec.). (An interval of once per second is not available.)
- Press <SET> to display <⏸>.
- Set the desired number with the <▲> <▼> keys, then press <SET>. (Returns to <□>.)
- Select **[OK]** to register the setting.

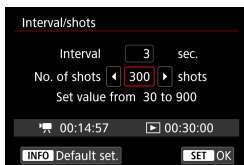

7 Set the number of shots.

- Select **[No. of shots]**. Use the <◀> <▶> keys to set a value, then press <SET>.
- Refer to the **[⏸: Time required]** and **[▶: Playback time]** to set the number.

When [Custom] is set

- Select the digit.
- Press <SET> to display <□>.
- Set the desired number with the <▲> <▼> keys, then press <SET>. (Returns to <□>.)
- Check that **[▶: Playback time]** is not displayed in red.
- Select **[OK]** to register the setting.



- With **[Scene**]**, available intervals and numbers of shots are restricted, to suit the type of scene.
- For cards that can record time-lapse movies (card performance requirements), see 617.
- If the number of shots is set to 3600, the time-lapse movie will be approx. 2 min. in NTSC and approx. 2 min. 24 sec. in PAL.

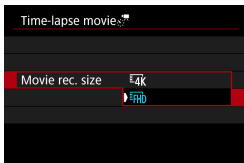

8 Select the desired movie recording size.

- **4K (3840×2160)**

The movie is recorded in 4K quality. The aspect ratio is 16:9.

The frame rate is 29.97 fps (**29.97P**) for NTSC and 25.00 fps (**25.00P**) for PAL, and movies are recorded in MP4 (**MP4**) format with ALL-I (**ALL-I**) compression.

Time-lapse movies are not recorded cropped, even when [**4K movie cropping**] is set to [**Enable**] in [**Movie rec. size**].

- **FHD (1920×1080)**

The movie will be recorded in Full High-Definition (Full HD) quality. The aspect ratio is 16:9.

The frame rate is 29.97 fps (**29.97P**) for NTSC and 25.00 fps (**25.00P**) for PAL, and movies are recorded in MP4 (**MP4**) format with ALL-I (**ALL-I**) compression.



9 Configure [Auto exposure].

● Fixed 1st frame

When taking the first shot, metering is performed to set the exposure automatically to match the brightness. The exposure setting for the first shot will be applied to subsequent shots. Other shooting-related settings for the first shot will also be applied for subsequent shots.

● Each frame

Metering is also performed for each subsequent shot to set the exposure automatically to match the brightness. Note that if functions such as Picture Style and white balance are set to **[Auto]**, they will be set automatically for each subsequent shot.

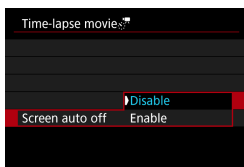

10 Configure [Screen auto off].

● Disable

Even during time-lapse movie recording, the image will be displayed. (The screen turns off only at the time of shooting.) Note that the screen will turn off when approx. 30 min. elapse after the shooting started.

● Enable

Note that the screen will turn off when approx. 10 sec. elapse after the shooting started.



- During time-lapse movie recording, you can press the <INFO> button to turn on/off the screen.

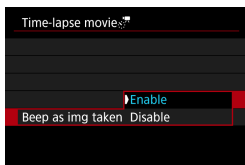

11 Set the beeper.

- Select [**Beep as img taken**].
- If [**Disable**] is set, the beeper will not sound for shooting.

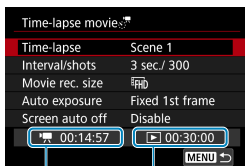

12 Check the settings.

(1) Time required

Indicates the time required to shoot the set number of shots with the set interval. If it exceeds 24 hours, “*** days” will be displayed.

(2) Playback time

Indicates the movie recording time (time required to play back the movie) when creating the time-lapse movie in 4K movie or Full HD movie from the still photos taken with the set intervals.

13 Close the menu.

- Press the <MENU> button to turn off the menu screen.

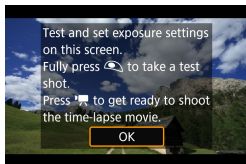

14 Read the message.

- Read the message and select **[OK]**.

15 Take test shots.

- As with still photo shooting, set the exposure and shooting functions, then press the shutter button halfway to focus.
- Press the shutter button completely to take test shots. The still photos will be recorded to the card.
- If there are no problems with the test shots, go to the next step.
- To take test shots again, repeat this step.



- Test shots are captured in JPEG **L** quality.
- If you have set **[Half-press]** under **[Ψ : Shutter btn function for movies]** to **[Meter.+ Ψ Servo AF]**, it is automatically changed to **[Meter.+One-Shot AF]** when you set up time-lapse movie recording.

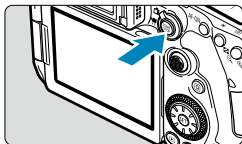

16 Press the <START/STOP> button.

- The camera will be ready to start recording a time-lapse movie.
- To return to step 15, press the movie shooting button again.



(1)

(2)

17 Record the time-lapse movie.

- Press the <INFO> button and check again the “Time required (1)” and “Interval (2)” displayed on the screen.
- Press the shutter button completely to start recording the time-lapse movie.
- AF will not work during time-lapse movie recording.
- While the time-lapse movie is recorded, the “●REC” mark will be displayed on the upper right of the screen, and <:REC> will blink on the LCD panel.
- To cancel recording time-lapse movies, set [Time-lapse] to [Disable].

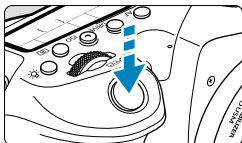



- If the card does not have enough free space to record the set number of shots, **[Playback time]** will be displayed in red. Although the camera can continue shooting, the shooting will stop when the card becomes full.
- If the movie file size exceeds 4 GB with the **[No. of shots]** settings and the card is not formatted in exFAT (📖 512), **[Playback time]** will be displayed in red. If you keep shooting in this condition and the movie file size reaches 4 GB, the time-lapse movie recording will stop.
- Do not point the camera toward an intense light source, such as the sun or an intense artificial light source. Doing so may damage the image sensor or the camera's internal components.
- **[Time-lapse movie]** cannot be set to an option other than **[Disable]** when the camera is connected to a computer with the interface cable, or when an HDMI cable is connected.
- Movie Servo AF will not function.
- If the shutter speed is 1/30 sec. or slower, the exposure of the movie may not be displayed properly (may differ from that of the resulting movie).
- Do not zoom the lens during time-lapse movie recording. Zooming the lens may cause the image to be out of focus, the exposure to change, or the lens aberration correction not to function properly.
- When recording a time-lapse movie under a flickering light, noticeable image flickering, horizontal stripes (noise), or irregular exposures may be recorded.
- Images that are displayed while time-lapse movies are being recorded may look different from the resulting movie. (For example, there may be inconsistent brightness from flickering light sources, or noise from a high ISO speed.)
- When recording a time-lapse movie under low light, the image displayed during shooting may look different from what is actually recorded in the movie. In such cases, the **[Exp.SIM]** icon will blink.
- If you move the camera from left to right (panning) or shoot a moving subject during time-lapse movie recording, the image may look extremely distorted.
- During time-lapse movie recording, auto power off will not take effect. Also, you cannot adjust the shooting function and menu function settings, play back images, etc.
- Sound is not recorded for time-lapse movies.
- With time-lapse movie recording, you can press the shutter button completely to start or stop the movie recording regardless of the **[☑: Shutter btn function for movies]** setting.
- With **[Interval]** set to less than 3 sec. and **[Auto exposure]** set to **[Each frame]**, if the brightness differs greatly from the preceding shot, the camera may not shoot at the set interval.



- If the shutter speed exceeds the shooting interval (such as for long exposures), or if a slow shutter speed is set automatically, the camera may not be able to shoot at the set interval. Shooting may also be prevented by shooting intervals nearly the same as the shutter speed.
- If the next scheduled shot is not possible, it will be skipped. This may shorten the recording time of the created time-lapse movie.
- If the time it takes to record to the card exceeds the shooting interval due to the shooting functions set or card performance, some of the shots may not be taken with the set intervals.
- Even if **[Screen auto off]** is set to **[Disable]**, the screen will turn off during the exposure. Also note that images may not be displayed if the interval between shots is too brief.
- The captured images are not recorded as still photos. Even if you cancel the time-lapse movie recording after only one shot is taken, it will be recorded as a movie file.
- If you connect the camera to a computer with the interface cable and use EOS Utility (EOS software), set **[📷: Time-lapse movie]** to **[Disable]**. If an option other than **[Disable]** is selected, the camera cannot communicate with the computer.
- During time-lapse movie recording, the lens's Image Stabilizer will not operate.
- Time-lapse movie recording ends if the power switch is set to <OFF> or auto power off is activated, and the setting is changed to **[Disable]**.
- Even if a flash is used, it will not fire.
- The following operations cancel standby for time-lapse movie recording and switch the setting to **[Disable]**.
 - Selecting either **[Clean now 🧼]** under **[🔧: Sensor cleaning]** or selecting **[🔧: Clear all camera settings]**.
 - Setting the Mode dial to <SCN> or <📷>.

- If you start time-lapse movie recording while the white **[10]** icon (📖 326) is displayed, the image quality of the time-lapse movie may deteriorate. It is recommended that you start time-lapse movie recording after the white **[10]** icon disappears (camera's internal temperature decreases).
- With **[Auto exposure]** set to **[Each frame]**, ISO speed, shutter speed, and aperture may not be recorded in the time-lapse movie Exif information in some modes.

- Using a tripod is recommended.
- Taking test shots as in step 15 and recording test movies for time-lapse movies beforehand is recommended.
- The movie's field of view coverage for both the 4K and Full HD time-lapse movie recording is approx. 100%.
- To cancel the time-lapse movie recording in progress, either press the shutter button completely or press the **< START / STOP >** button. The time-lapse movie shot so far will be recorded on the card.
- If the time required for shooting is more than 24 hours but not more than 48 hours, "2 days" will be indicated. If three or more days are required, the number of days will be indicated in 24-hour increments.
- Even if the time-lapse movie's playback time is less than 1 sec., a movie file will still be created. For **[Playback time]**, "00'00"" will be displayed.
- If the shooting time is long, using the household power outlet accessories (sold separately) is recommended.
- YCbCr 4:2:0 (8-bit) color sampling and the Rec. ITU-R BT.709 color space are used for 4K/Full HD time-lapse movies.



You can use Remote Controller RC-6 (sold separately) or Wireless Remote Control BR-E1 (sold separately) to start and stop the time-lapse movie recording. Set [: Remote control] to [Enable] beforehand.

● With Remote Controller RC-6

Camera Status/Remote Control Setting	<2> 2-sec. Delay	<●> Immediate Release
Test-shooting screen	To shooting-ready	Still photo shooting
Shooting-ready	To test-shooting screen	Starts shooting
During time-lapse movie recording	Ends recording	Ends recording

● With Wireless Remote Control BR-E1

- First, pair the BR-E1 with the camera (464).
- Take test shots, then when the camera is ready to shoot (as in step 16 on 307), set the BR-E1's release mode/movie shooting switch to <●> (immediate release) or <2> (release after 2-sec. delay).
- If the remote control's switch has been set to < >, the time-lapse movie recording cannot start.

Camera Status/Remote Control Setting	<●> Immediate Release <2> 2-sec. Delay	< > Movie Recording
Test-shooting screen	Still photo shooting	To shooting-ready
Shooting-ready	Starts shooting	To test-shooting screen
During time-lapse movie recording	Ends recording	Ends recording

Total Possible Time for Time-lapse Movie Recording

For guidelines on how long you can record time-lapse movies (until the battery runs out), see 619.

Recording Video Snapshots

Record a series of short video snapshots, each a few seconds long, and the camera will combine them to create a video snapshot album that shows these highlights of your trip or event.

Video snapshots are available when the movie recording size is set to **FHD 29.97P IPB** (NTSC) / **FHD 25.00P IPB** (PAL).

Video snapshot albums can also be played back with background music (📖 376).

Creating a Video Snapshot Album

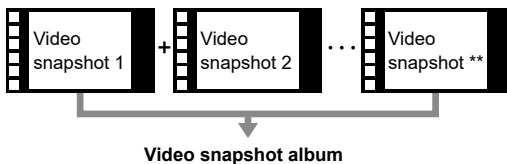

Configuring the Video Snapshot Settings

1 Set the Mode dial to a mode other than **<📷>**.

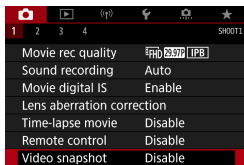

2 Specify [**📷**: Video snapshot].

- Select [**Enable**].

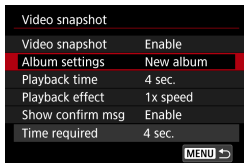

3 Specify [**Album settings**].

- Select [**Create a new album**].
- Read the message and select [**OK**].

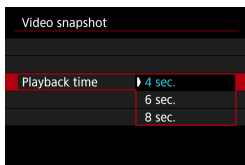

4 Specify [Playback time].

- Specify playback time per video snapshot.

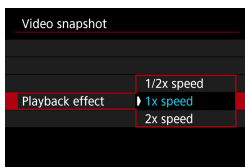

5 Specify [Playback effect].

- This setting determines how fast albums are played back.

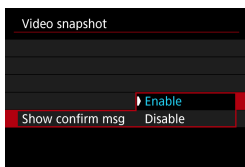

6 Specify [Show confirm msg].

- Select [Enable].

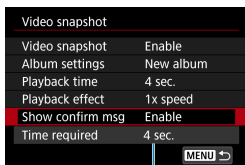

7 Check the required recording time.

- The time required to record each video snapshot is indicated (1), based on the playback time and effect.

(1)

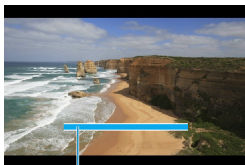

(2)

8 Close the menu.

- Press the <MENU> button to close the menu.
- A blue bar is displayed to indicate the recording time (2).

Creating a Video Snapshot Album

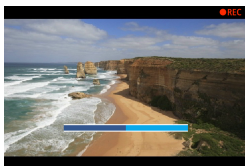

9 Record the first video snapshot.

- Press the movie shooting button to start recording.
- The blue bar indicating recording time gradually decreases, and after the specified time elapses, recording stops automatically.
- A confirmation message is displayed (📖 315).



10 Save as a video snapshot album.

- Select [📖 Save as album].
- The clip is saved as the first video snapshot in the album.



11 Record your next video snapshots.

- Repeat step 9 to record the next video snapshot.
- Select [📖 Add to album].
- To create another album, select [📖 Save as a new album].
- Repeat step 11 as needed.

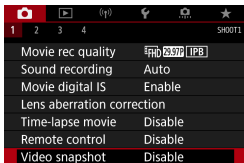

- 12 Stop recording video snapshots.**
- Set **[Video snapshot]** to **[Disable]**. To return to normal movie recording, be sure to specify **[Disable]**.
 - Press the **<MENU>** button to close the menu and return to normal movie recording.

Options in Steps 10 and 11

Function	Description
Save as album (step 10)	Saves the clip as the first video snapshot in an album.
Add to album (step 11)	Adds the current video snapshot to the album recorded most recently.
Save as a new album (step 11)	Creates a new album and saves the clip as the first video snapshot. This album file is different from the one recorded most recently.
Playback video snapshot (steps 10, 11)	Plays the video snapshot just recorded.
Do not save to album (step 10)	Deletes the recently recorded video snapshot without saving it to an album. Select [OK] on the confirmation dialog.
Delete without saving to album (step 11)	

- If you prefer to record the next video snapshot immediately, set **[Show confirm msg]** under **[CAM: Video snapshot]** to **[Disable]**. This setting enables you to record the next video snapshot immediately, without a confirmation message.

Adding to an Existing Album

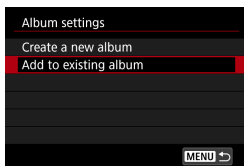

- 1 **Select [Add to existing album].**
 - Follow step 3 on [312](#) to select **[Add to existing album]**.



- 2 **Select an existing album.**
 - Turn the $\langle \text{DIAL} \rangle$ dial to select an existing album, then press $\langle \text{SET} \rangle$.
 - Select **[OK]**.
Some video snapshot settings will be updated to match settings of the existing album.

- 3 **Close the menu.**
 - Press the $\langle \text{MENU} \rangle$ button to close the menu.
The video snapshot recording screen is displayed.

- 4 **Record a video snapshot.**
 - Record the video snapshot, referring to “Creating a Video Snapshot Album” ([314](#)).

- You cannot select an album shot with another camera.

General Video Snapshot Precautions

- No sound is recorded when you set **[Playback effect]** to **[1/2x speed]** or **[2x speed]**.
- Recording time per video snapshot is only approximate. It may differ slightly from the actual recording time indicated during playback, due to the frame rate and other factors.

Movie Servo AF

With this function enabled, the camera focuses on the subject continuously during movie recording.

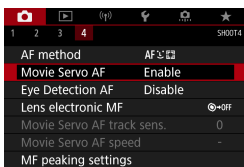

1 Select [: Movie Servo AF].

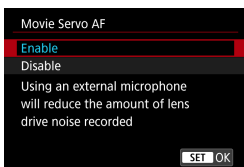

2 Select [Enable].

● When [Enable] is set:

- The camera focuses on the subject continuously even when you are not pressing the shutter button halfway.
- To keep the focus at a specific position, or if you prefer not to record mechanical sounds from the lens, you can temporarily stop Movie Servo AF by touching [] in the lower left of the screen.
- When Movie Servo AF is paused, if you return to movie recording after operations such as pressing the <MENU> or <▶> button or changing the AF method, Movie Servo AF will resume.

● When [Disable] is set:

- Press the shutter button halfway or press the <AF-ON> button to focus.



Cautions When [Movie Servo AF] is Set to [Enable]

- **Shooting Conditions that Make Focusing Difficult**
 - A fast-moving subject approaching or moving away from the camera.
 - A subject moving at a close distance to the camera.
 - When shooting with a higher f/number.
 - Also see “Shooting Conditions that Make Focusing Difficult” on 146.
- Since the lens is driven continuously and the battery power is consumed, the possible movie recording time (618) will be shortened.
- With certain lenses, the mechanical sound for focusing may be recorded. In this case, using Directional Stereo Microphone DM-E1 (sold separately) may reduce such sounds in the movie.
- Movie Servo AF will pause during zooming or magnified view.
- During movie recording, if a subject approaches or moves away or if the camera is moved vertically or horizontally (panning), the recorded movie image may momentarily expand or contract (change in image magnification).

Movie Servo AF Track Sensitivity



You can adjust the tracking sensitivity (to one of seven levels), which affects responsiveness if the subject strays from the AF point during Movie Servo AF, as when interfering objects move across AF points or when you pan.

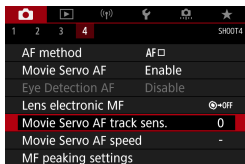

1 Select [CAMERA: Movie Servo AF track sens.].

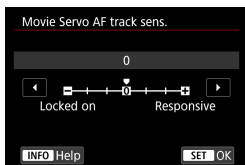

● Locked on: -3/-2/-1

With this setting, the camera is less likely to track a different subject if the main subject strays from the AF point. The closer the setting is to the minus (-) symbol, the less the camera is inclined to track a different subject. It is effective when you want to prevent the AF points from rapidly tracking something that is not the intended subject during panning or when an obstacle cuts across the AF points.

● Responsive: +1/+2/+3

This makes the camera more responsive when tracking a subject that covers the AF point. The closer the setting is to the plus (+) symbol, the more responsive the camera is. It is effective when you want to keep tracking a moving subject as its distance from the camera changes or to rapidly focus on another subject.



- Available when [CAMERA: Movie Servo AF] is set to [Enable] and [CAMERA: AF method] is set to [1-point AF].
- Operation when [CAMERA: AF method] is set to an option other than [1-point AF] is equivalent to a setting of [0].



- With certain lenses, even if you adjust the AF speed, the speed may not change.



- Available when [: **Movie Servo AF**] is set to [**Enable**] and [: **AF method**] is set to [**1-point AF**].
- Operation when [: **AF method**] is set to an option other than [**1-point AF**] is equivalent to setting [**AF speed**] to [**Standard (0)**].
- An asterisk to the right of [: **Movie Servo AF speed**] indicates that the default setting has been modified.

Other Menu Functions

[📷1]

● **Lens aberration correction** ☆

Peripheral illumination and chromatic aberration can be corrected as you record movies. For details on lens aberration correction, see 📖 206.

● **Remote control shooting**

When **[Enable]** is set, you can start or stop movie recording using Remote Controller RC-6 or Wireless Remote Control BR-E1 (sold separately).

With Remote Controller RC-6

The [📷] is displayed on the LCD panel. Set the release timing switch to the <2> position, then press the Transmit button. When set to the <●> (immediate shooting) position, operation follows the [📷: Shutter btn function for movies] setting.

With Wireless Remote Control BR-E1

First, pair the BR-E1 with the camera (📖 464).

Set the release mode/movie shooting switch to the <📷> position, then press the release button.

For details on Time-lapse movie recording, see 📖 311.

[📷2]

● 📷 **ISO speed settings** ☆

● **ISO speed**

In [📷M] mode, you can set the ISO speed manually. You can also select ISO Auto.



● **ISO speed range**

For movie recording, you can set the manual ISO speed setting range (minimum and maximum limits).

● **Max for Auto**

You can set the maximum limit for ISO Auto in movie recording in [📷] mode or in [📷M] mode with ISO Auto.

-  **Max for Auto**

You can set the maximum limit for ISO Auto in 4K time-lapse/Full HD time-lapse movie recording in  mode or in  mode with ISO Auto.



- ISO 25600 is an expanded ISO speed (indicated by **[H]**).
- ISO 25600 is not available when recording 4K movies, 4K time-lapse movies, or Full HD time-lapse movies.

- **Highlight tone priority** ☆

You can reduce overexposed, clipped highlights as you record movies. For details on Highlight tone priority, see  219.



- **[Enhanced]** is not available (not displayed) when recording movies with : **Highlight tone priority** set.

● Auto slow shutter ☆

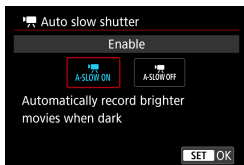

You can choose whether to record movies that are brighter and less affected by image noise than when set to **[Disable]** by automatically slowing the shutter speed under low light.

Available in [] shooting mode. Applies when the frame rate of the movie recording size is **59.94P** or **50.00P**.

● **Disable**

Enables you to record movies with smoother, more natural movement, less affected by subject shake than when set to **[Enable]**. Note that under low light, movies may be darker than when set to **[Enable]**.

● **Enable**

Enables you to record brighter movies than when set to **[Disable]** by automatically reducing the shutter speed to 1/30 sec. (NTSC) or 1/25 sec. (PAL) under low light.



- Setting to **[Disable]** is recommended when recording moving subjects under low light, or when afterimages such as trails may occur.



● HDMI info disp ☆



You can configure information display for image output via an HDMI cable.

● With info

The image, shooting information, AF points, and other information is shown on the other device via HDMI. Note that the camera screen goes off.

Recorded movies are saved to the card.

● Clean / 4K output

HDMI output consists solely of 4K movies. Shooting information and AF points are also displayed on the camera, but no image is recorded to the card. Note that Wi-Fi communication is not available.

● Clean / FHD output

HDMI output consists solely of Full HD movies. Shooting information and AF points are also displayed on the camera, but no image is recorded to the card. Note that Wi-Fi communication is not available.

General Movie Recording Cautions



Red [🔴] Internal Temperature Warning Icon

- If the camera's internal temperature increases due to prolonged movie recording or under a high ambient temperature, a red [🔴] icon will appear.
- The red [🔴] icon indicates that movie recording will soon be terminated automatically. If this happens, you will not be able to shoot again until the camera's internal temperature decreases. Turn off the power and let the camera rest for a while. Note that the time until movie recording stops automatically when the red [🔴] icon is displayed varies depending on shooting conditions.
- Recording a movie at a high temperature for a prolonged period will cause the red [🔴] icon to appear earlier. When you are not shooting, always turn off the camera.

[🔴] Display

- The camera's internal temperature may rise and [🔴] may be displayed after extended movie recording, or after extended Live View use with [54K movie cropping] set to [Enable]. Movie recording is not possible as long as [🔴] is displayed. If [🔴] appears during movie recording, the camera will turn off automatically in approx. 3 min.
- Wait and allow the camera to cool down when [🔴] is displayed or the camera stops movie recording in progress, either by turning it off or canceling movie recording mode.

Recording and Image Quality

- If the attached lens has an Image Stabilizer and you set the Image Stabilizer (IS) switch to <ON>, the Image Stabilizer will operate at all times even if you do not press the shutter button halfway. The Image Stabilizer consumes battery power and may shorten the total movie recording time depending on the shooting conditions. When the Image Stabilizer is not necessary, such as when using a tripod, it is recommended that you set the IS switch to <OFF>.
- If the brightness changes as you record a movie with auto exposure, the movie may appear to stop momentarily. In this case, record movies with manual exposure.
- If there is a very bright light source in the image, the bright area may appear black on the screen. Movies are recorded almost exactly as they appear on the screen.
- Image quality may be lower when recording movies under a combination of conditions such as high ISO speeds, high temperatures, low shutter speeds, and low light.
- Recording movies over an extended period may cause the camera's internal temperature to rise and affect image quality. Turn off the camera when possible if you are not recording movies.
- If you play back a movie with other devices, image or sound quality may decline or playback may not be possible (even if the devices support MP4 format).



Recording and Image Quality

- If you use a card with a slow writing speed, an indicator may appear on the right of the screen during movie recording. It indicates how much data has not yet been written to the card (remaining capacity of the internal buffer memory). The slower the card, the faster the indicator will climb upward. If the indicator (1) becomes full, movie recording will stop automatically.
- If the card has a fast writing speed, the indicator will either not appear or the level (if displayed) will hardly go upward. First, record a few test movies to see if the card can write fast enough.
- If the indicator indicates that the card is full and movie recording stops automatically, the sound near the end of the movie may not be recorded properly.
- If the card's writing speed is slow (due to fragmentation) and the indicator appears, formatting the card may make the writing speed faster.

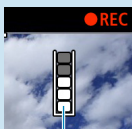

(1)

Audio Restrictions

- Note that the following restrictions apply when **[Movie rec. size]** is set to **[FHD 29.97P 1PB]** (NTSC) or **[FHD 25.00P 1PB]** (PAL), when **[C.Fn III-9: Audio compression]** is set to **[Enable]**, and for Basic Zone or video snapshots.
 - Sound will not be recorded for approx. the last two frames.
 - When you play back movies on Windows, movie images and sound may become slightly out of synchronization.



Playback

This chapter covers topics related to playback—playing back captured still photos and movies—and introduces menu settings on the Playback ([▶]) tab.



- Normal display or selection on this camera may not be possible for images captured on other cameras, or images from this camera that have been edited or renamed on a computer.
- Images that cannot be used with playback functions may be displayed.

Tab Menus: Playback

● Playback 1

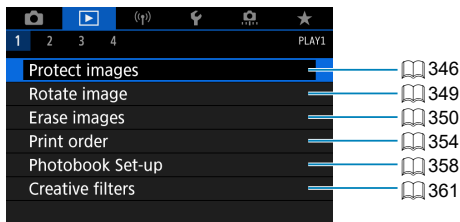

● Playback 2

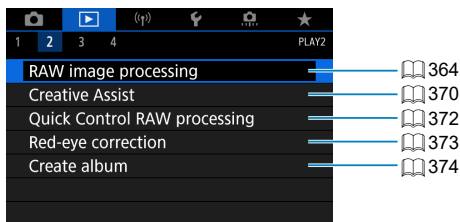

● Playback 3

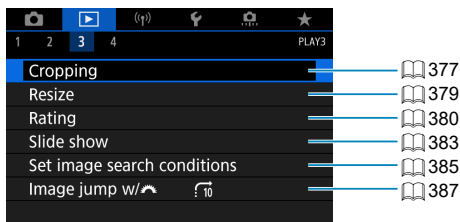

- ❗ ● [▶: RAW image processing] and [▶: Quick Control RAW processing] are not displayed in Basic Zone modes.

● Playback 4

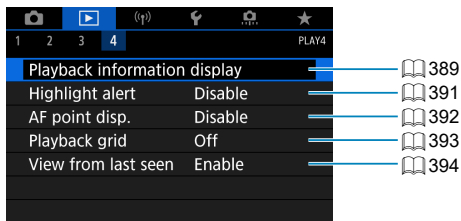

Image Playback

Single-Image Display



1 Play back the image.

- Press the <▶> button.
The last image captured or played back will appear.

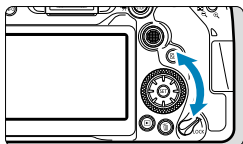

2 Select an image.

- To play back images starting with the most recent, turn the <◀> dial counterclockwise. To play back images starting with the first captured image, turn the dial clockwise.
- Images can also be selected with <◀>.
- Each time you press the <INFO> button, the display will change.



No information



Basic information display

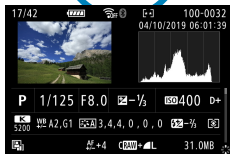

Shooting information display

3 Exit the image playback.

- Press the <▶> button to exit the image playback and return to shooting-ready state.



- When RAW images shot with [📷: Still img aspect ratio] set to an option other than [3:2] (📖 202) are played back, frame lines indicating the image area will be displayed.
- If the search conditions are set with [▶: Set image search conditions] (📖 385), only the filtered images will be displayed.

Shooting Information Display

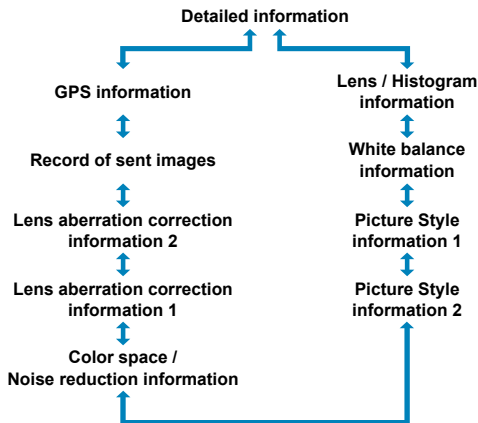

With the shooting information screen displayed (📖 332), you can press the <▲> <▼> keys to change the shooting information displayed at the screen bottom as follows.



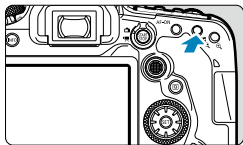

Index Display (Multiple-Image Display)



1 Switch to the index display.



- During image playback, press the <   > button.
- The 4-image index display will appear. The selected image is highlighted with an orange frame.

Pressing the <   > button again switches display from 9 images to 36, and then to 100.

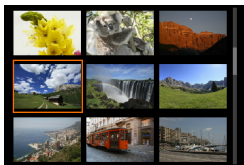
Pressing the <  > button switches display from 100 images to 36, 9, 4, and then single-image display.



2 Select an image.

- Turn the <  > or <  > dial to move the orange frame, then select the image.
- Press <  > in the index display to display the selected image in the single-image display.

Touch Playback

The camera features a touch-screen panel that you can touch to control playback. Supported touch operations are like those used with smartphones and similar devices. First, press the <▶> button to prepare for touch playback.

Image browsing



Jump display



Index display



Magnified view



- You can also magnify display by double-tapping with one finger.

Magnified Image Display

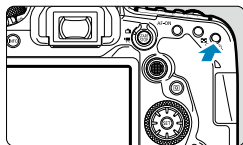

1 Magnify the image.

- During image playback, press the $\langle \text{Q} \rangle$ button.
The magnified view will appear. The magnified area position (1) will be displayed on the lower right of the screen.
- Each press of the $\langle \text{Q} \rangle$ button enlarges display.
- Each press of the $\langle \text{Q} \rangle$ button reduces display. For index display (334), press the $\langle \text{Q} \rangle$ button again after the final reduction.



(1)

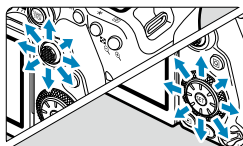

2 Scroll the image.

- Use $\langle \text{Q} \rangle$ $\langle \text{Q} \rangle$ to scroll the image vertically and horizontally.
- To cancel the magnified view, press the $\langle \text{Q} \rangle$ button or tap [↶].



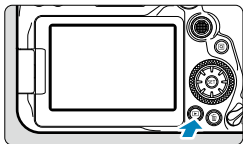

Movie Playback



- 1 Play back the image.**
- Press the  button.



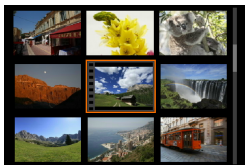

- 2 Select a movie.**
- Use the  dial to select the movie to play back.
 - In the single-image display, the  icon displayed on the upper left indicates a movie.
 - In the index display, perforations at the left edge of a thumbnail indicate a movie. As movies cannot be played back from the index display, press  to switch to the single-image display.



- 3 In the single-image display, press .**



- 4 Press  to play back the movie.**

- The movie will start playing back.
- You can pause playback and display the movie playback panel by pressing . Press it again to resume the playback.
- You can also adjust the volume during movie playback by using the   keys.



(1)

(1) Speaker

Movie Playback Panel

Item	Playback Operations
▶ Play	Pressing <ⓈET> toggles between playback and stop.
▶ Slow motion	Adjusts the slow motion speed with the <⦿> dial. The slow motion speed is indicated on the upper right of the screen.
◀ Skip backward	Skips backward 4 sec. each time you press <ⓈET>.
◀◀ Previous frame	Displays the previous frame each time you press <ⓈET>. Holding <ⓈET> down will rewind the movie.
◀◀ Next frame	Plays the movie frame-by-frame each time you press <ⓈET>. Holding <ⓈET> down will fast forward the movie.
▶ Skip forward	Skips forward 4 sec. each time you press <ⓈET>.
⌘ Edit	Displays the editing screen (📖 340).
📷 Frame Grab	Available when you play 4K or 4K time-lapse movies. Enables you to extract the current frame and save it as a JPEG still image (📖 342).
🎵 Background music	Plays back a movie with the selected background music (📖 376).
	Playback position
mm' ss"	Playback time (minutes:seconds)
🔊 Volume	Use the <▲> <▼> keys to adjust the speaker volume (📖 337).

Movie Playback Panel (Video Snapshot Albums)

Item	Playback Operations
Play	Pressing <SET> toggles between playback and stop.
Slow motion	Adjusts the slow motion speed with the <⦿> dial. The slow motion speed is indicated on the upper right of the screen.
Previous clip	Displays the first frame of the previous video snapshot.
Previous frame	Displays the previous frame each time you press <SET>. Holding <SET> down will rewind the movie.
Next frame	Plays the movie frame-by-frame each time you press <SET>. Holding <SET> down will fast forward the movie.
Next clip	Displays the first frame of the next video snapshot.
Erase clip	Erases the current video snapshot.
Edit	Displays the editing screen (📖 340).
Background music	Plays back an album with the selected background music (📖 376).
	Playback position
mm' ss"	Playback time (minutes:seconds)
Volume	Use the <▲> <▼> keys to adjust the speaker volume (📖 337).



- Adjust the volume using television controls when the camera is connected to a television for movie playback (📖 344). (Volume cannot be adjusted with the <▲> <▼> keys.)
- Movie playback may stop if the card's read speed is too slow or movie files have corrupted frames.



- For details on the movie recording time available, see 📖 618.

Editing a Movie's First and Last Scenes



1 In the single-image display, press **<SET>**.

- The movie playback panel will appear.



2 On the movie playback panel, select **[CUT]**.



3 Specify the part to be edited out.

- Select either **[CUT BEGINNING]** (Cut beginning) or **[CUT END]** (Cut end).
- Press the **<<>** **>>** keys to go back or forward one frame (or video snapshot) at a time. Keep holding down the **>>** key to fast forward the frames.
- After deciding which part to edit out, press **<SET>**. The portion indicated by a line at the bottom of the screen will remain.

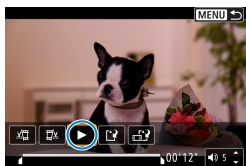

4 Check the edited movie.

- Select **[PLAY]** to play the edited movie.
- To change the edited part, go back to step 3.
- To cancel the editing, press the **<MENU>** button.

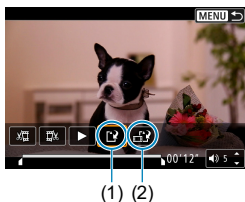

5 Save the image.

- Select [**▶**] (1).
- The save screen will appear.
- To save it as a new movie, select [**New file**]. To save it and overwrite the original movie file, select [**Overwrite**].
- Select [**▶**] (2) to save a compressed version of the file. 4K movies are converted to Full HD movies before compression.
- On the confirmation dialog, select [**OK**] to save the edited movie and return to the movie playback screen.



- Because editing is performed in approx. 1-sec. increments (at the position indicated by **[⌘]** at the bottom of the screen), the actual position where movies are trimmed may differ from your specified position.
- Movies shot with another camera cannot be edited with this camera.
- You cannot edit a movie when the camera is connected to a computer.
- Compress and save is not available for movie recording sizes of **[FHD 29.97P]** **[IPB]** (NTSC) or **[FHD 25.00P]** **[IPB]** (PAL).



- For instructions on editing video snapshot albums, see “Editing Video Snapshot Albums” (📖 374).

Frame Extraction from 4K Movies or 4K Time-Lapse Movies

From 4K movies or 4K time-lapse movies, you can select individual frames to save as approx. 8.3 megapixel (3840×2160) JPEG still images. This function is called “Frame Grab (4K frame capture)”.

1 Play back the image.

2 Select a 4K movie or 4K time-lapse movie.

- Press the <▶> button.
- Select with <⊙>.
- On the shooting information screen (631), 4K movies and 4K time-lapse movies are indicated by an [4K] icon.
- In index display, press <SET> to switch to single-image display.

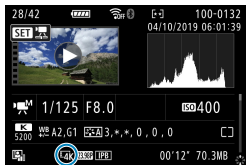

3 In the single-image display, press <SET>.

- The movie playback panel will appear.

4 Select a frame to grab.

- Use the movie playback panel to select the frame to grab as a still photo.
- For movie playback panel instructions, see 338.



5 Select [Gr].





6 Save the image.

- Select **[OK]** to save the current frame as a JPEG still image.

7 Select the image to display.

- Check the destination folder and image file number.
- Select **[View original movie]** or **[View extracted still image]**.



- Frame grabbing is not possible with Full HD movies, Full HD time-lapse movies, or with 4K movies or 4K time-lapse movies from a different camera.

Playback on a TV Set

By connecting the camera to a television with an HDMI cable, you can play back the captured still photos and movies on the television. Using the HDMI Cable HTC-100 (sold separately) is recommended.

If the image does not appear on the TV screen, check if the [Video system] is correctly set to [For NTSC] or [For PAL] (depending on the video system of your television).

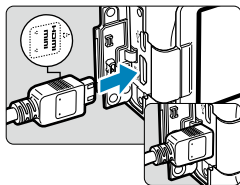

1 Connect the HDMI cable to the camera.

- With the plug's <▲ HDMI MINI> logo facing the front of the camera, insert it into the <HDMI OUT> terminal.

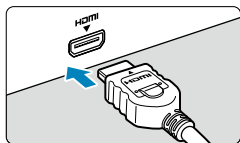

2 Connect the HDMI cable to the television.

- Connect the HDMI cable to the television's HDMI IN port.

3 Turn on the television and switch the television's video input to select the connected port.

4 Set the camera's power switch to <ON>.

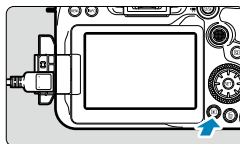

5 Press the <▶> button.

- The image will appear on the TV screen. (Nothing will be displayed on the camera screen.)
- The images will automatically be displayed at the optimum resolution matching the connected television.



- Adjust movie sound volume with the TV set. The sound volume cannot be adjusted with the camera.
- Before connecting or disconnecting the cable between the camera and television, turn off the camera and television.
- Depending on the television, part of the image displayed may be cut off.
- Do not connect any other device's output to the camera's <HDMI OUT> terminal. Doing so may cause a malfunction.
- Certain televisions may not display the images due to incompatibility.
- It may take some time before images are displayed. To avoid delay, set [👉: **HDMI resolution**] to [1080p] (📖 543).
- Touch-screen operations are not supported while the camera is connected to a television.

Protecting images

You can protect important images from being accidentally erased.

Protecting a Single Image

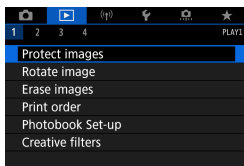

1 Select [: Protect images].

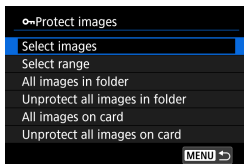

2 Select [Select images].

3 Select an image.

- Turn the dial to select the image to be protected.

4 Protect the image.

- Press to protect the selected image. The icon (1) will appear at the top of the screen.
- To cancel the image protection, press again. The icon will disappear.
- To protect another image, repeat steps 3 and 4.



Specifying the Range of Images to be Protected

While looking at the images in the index display, you can specify the first and last images for a range to protect all the specified images at once.

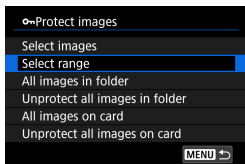

1 Select [Select range].

- Select [Select range] in [▶]: Protect images].

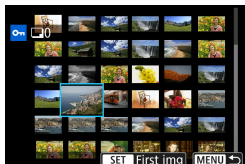

2 Specify the range of images.

- Select the first image (start point).
- Next, select the last image (end point).
The images in the specified range will be protected and the <▶> icon will appear.
- To select another image to be protected, repeat step 2.

Protecting All Images in a Folder or on a Card

You can protect all the images in a folder or on a card at once.

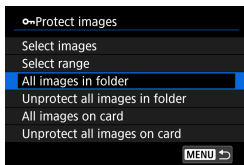

When you select **[All images in folder]** or **[All images on card]** in **[▶]: Protect images**, all the images in the folder or on the card will be protected.

To cancel the selection, select **[Unprotect all images in folder]** or **[Unprotect all images on card]**.

If the search conditions are set with **[▶]: Set image search conditions** (📖 385), the display will change to **[All found images]** and **[Unprotect all found]**.

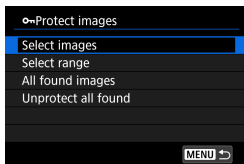

If you select **[All found images]**, all the images filtered by the search conditions will be protected.

If you select **[Unprotect all found]**, the protection of all the filtered images will be canceled.



- If you format the card (📖 511), the protected images will also be erased.



- Once an image is protected, it cannot be erased by the camera's erase function. To erase a protected image, you must first cancel the protection.
- If you erase all the images (📖 353), only the protected images will remain. This is convenient when you want to erase all unnecessary images at once.

Image Rotation

You can use this feature to rotate the displayed image to the desired orientation.

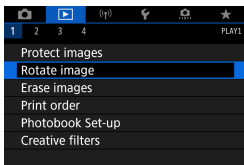

1 Select []: Rotate image].

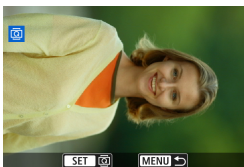

2 Select an image.

- Select with < >.

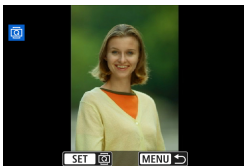

3 Rotate the image.

- Each time you press < >, the image will rotate clockwise as follows: 90° → 270° → 0°.
- To rotate another image, repeat steps 2 and 3.



- If you set [: Auto rotate] to [On] (510) before taking vertical shots, you need not rotate the image with this function.
- If the rotated image is not displayed in the rotated orientation during image playback, set [: Auto rotate] to [On].

Erasing Images

You can either select and erase unnecessary images one by one or erase them in one batch. Protected images (📖 346) will not be erased.

- ⚠️ Once an image is erased, it cannot be recovered. Make sure you no longer need the image before erasing it. To prevent important images from being erased accidentally, protect them.

Erasing a Single Image

1 Select the image to be erased.

- Press the <▶> button.
- Select with <🕒>.



2 Press the <🗑> button.



3 Erase the images.

JPEG or RAW images or movies

- Select [Erase].



RAW+JPEG images

- Select an item.

Checkmarking [✓] Images to Be Erased in a Batch

By adding checkmarks to the images to be erased, you can erase all those images at once.

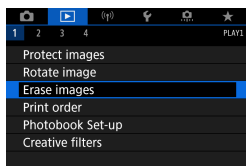

1 Select []: Erase images].

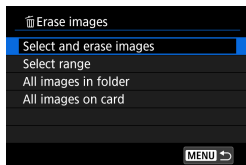

2 Select [Select and erase images].



3 Select an image.

- Turn the dial to select the image to be erased, then press .
- To select another image to be erased, repeat step 3.

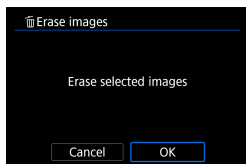

4 Erase the images.

- Press the button, then press [OK].

Specifying the Range of Images to Be Erased

While looking at the images in the index display, you can specify the first and last images for a range to erase all the specified images at once.

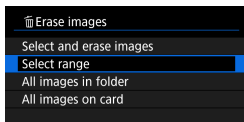

- 1 **Select [Select range].**
 - Select [Select range].

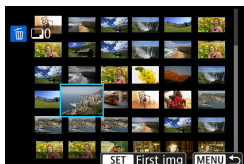

- 2 **Specify the range of images.**
 - Select the first image (start point).
 - Next, select the last image (end point).

- 3 **Press the <  > button.**

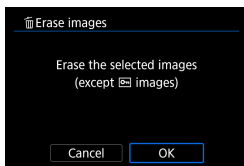

- 4 **Erase the images.**
 - Select [OK].

Erasing All Images in a Folder or on a Card

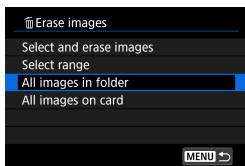

When [**▶** : **Erase images**] is set to [**All images in folder**] or [**All images on card**], all the images in the folder or on the card will be erased.

If the search conditions are set with [**▶** : **Set image search conditions**] (📖 385), the display will change to [**All found images**].

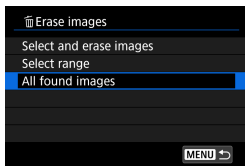

If you select [**All found images**], all the images filtered by the search conditions will be erased.



- To erase all the images including protected images, format the card (📖 511).

Digital Print Order Format (DPOF)

DPOF (Digital Print Order Format) enables you to print images recorded on the card according to your printing instructions such as the image selection, quantity to print, etc. You can print multiple images in one batch or create a print order for a photofinisher.

You can set the print settings such as print type, date imprinting, file number imprinting, etc. The print settings will be applied to all the images specified for printing. (They cannot be set individually for each image.)

Print Options

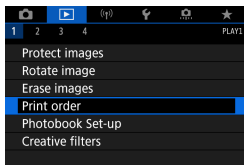

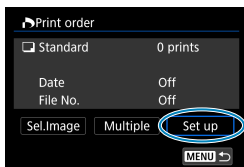

1 Select [: Print order].



2 Select [Set up].

3 Set the options as desired.

- Set the [Print type], [Date], and [File No.].

Print type	 Standard	Prints one image on one sheet.
	 Index	Multiple thumbnail images are printed on one sheet.
	 Both	Prints both the standard and index prints.
Date	On	[On] imprints the recorded date of the captured image.
	Off	
File number	On	[On] imprints the file number.
	Off	

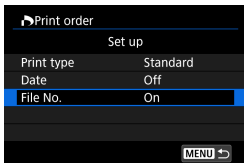

4 Exit the setting.

- Press the <MENU> button.
- Next, select **[Sel.Image]** or **[Multiple]** to specify the images to be printed.



- If you print an image with a large image size using the **[Index]** or **[Both]** setting (📖 354), the index print may not be printed with certain printers. In this case, resize the image (📖 379), then print the index print.
- Even if **[Date]** and **[File No.]** are set to **[On]**, the date or file number may not be imprinted, depending on the print type setting and printer.
- With **[Index]** prints, the **[Date]** and **[File No.]** cannot both be set to **[On]** at the same time.
- When printing with DPOF, use the card for which print order specifications are set. You cannot print in the specified print order if you extract just the images from the card for printing.
- Certain DPOF-compliant printers and photofinishers may not be able to print the images as you specified. Refer to the printer's instruction manual before printing, or check with your photofinisher about compatibility when ordering prints.
- Do not use this camera to configure print settings for images with DPOF settings set up on another camera. All the print orders may be overwritten inadvertently. Also, the print order may not be possible, depending on the image type.

Selection of Images for Printing

● Selecting Images

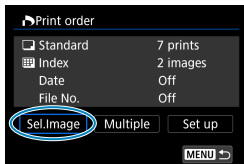

Select and specify the images one by one.

Press the <MENU> button to save the print order to the card.



(1)

(2)

● Standard/Both

Press <SET> to print a copy of the displayed image. By turning the <DIAL>, you can specify to print up to 99 copies.

- (1) Quantity
- (2) Total images selected



(3)

(4)

● Index

Press <SET> to add a checkmark to the box [✓]. The image will be included in the index print.

- (3) Checkmark
- (4) Index icon

● Selecting Multiple Images

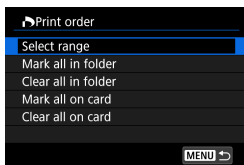

● Select Range

Under [**Multiple**], select [**Select range**]. Selecting the first and last images of the range marks all the images in the range with a checkmark [✓], and one copy of each image will be printed.

- **All Images in a Folder**



Select [**Mark all in folder**] and select the folder. A print order for one copy of all the images in the folder will be specified.

If you select [**Clear all in folder**] and select the folder, the print order for all the images in the folder will be canceled.

- **All Images on a Card**

If you select [**Mark all on card**], one copy of all the images on the card will be specified for printing.

If you select [**Clear all on card**], the print order will be cleared for all the images on the card.

If the search conditions are set with []: **Set image search conditions**] ( 385) and you select [**Multiple**], the display will change to [**Mark all found images**] and [**Clear all found images**].

- **All Found Images**

If you select [**Mark all found images**], one copy of all the images filtered by the search conditions will be specified for printing.

If you select [**Clear all found images**], all the print order of the filtered images will be cleared.



- RAW images or movies cannot be specified for printing. Note that RAW images or movies will not be specified for printing even if you specify all images with [**Multiple**].
- When using a PictBridge-compatible printer, do not specify more than 400 images for one print order. If you specify more than this, the images may not all be printed.

Specifying Images for a Photobook

You can specify up to 998 images for printing in a photobook. When you use EOS Utility (EOS software) to import images to a computer, the specified images for a photobook will be copied to a dedicated folder. This function is useful for ordering photobooks online.

Specifying One Image at a Time

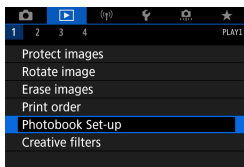

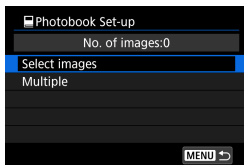

1 Select [: Photobook Set-up].

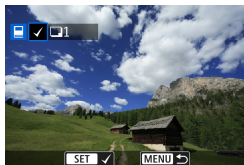

2 Select [Select images].



3 Select the image to be specified.

- Turn the < dial to select the image to be specified for a photobook, then press < >.
- To select other images to be specified for a photobook, repeat step 3.

Specifying the Image Range for a Photobook

While looking at the images in the index display, you can specify the range (start point to end point) of images to be specified for a photobook at once.

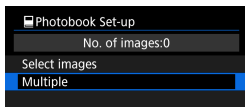

1 Select [Multiple].

- Under [▶]: **Photobook Set-up**, select **[Multiple]**.

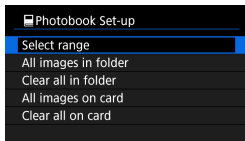

2 Select [Select range].

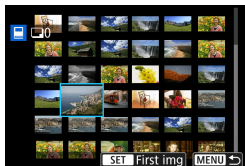

3 Specify the range of images.

- Select the first image (start point).
- Next, select the last image (end point).
A checkmark [✓] will be appended to all the images within the range between first and last images.

Specifying All Images in a Folder or on a Card

You can specify all the images in a folder or on a card at once for a photobook.

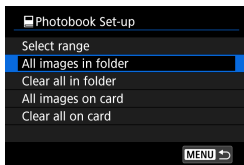

Under [**▶**]: **Photobook Set-up**], you can set [**Multiple**] to [**All images in folder**] or [**All images on card**] to specify all the images in the folder or on the card for a photobook.

To cancel the selection, select [**Clear all in folder**] or [**Clear all on card**].

If the search conditions are set with [**▶**]: **Set image search conditions**] (**385**) and you select [**Multiple**], the display will change to [**Mark all found images**] and [**Clear all found images**].

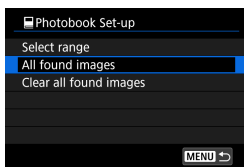

If you select [**All found images**], all the images filtered by the search conditions will be specified for the photobook.

If you select [**Clear all found images**], all the photobook order of the filtered images will be cleared.



- RAW images or movies cannot be specified for the photobook. Note that RAW images or movies will not be specified for the photobook even if you specify all images with [**Multiple**].
- Do not use this camera to configure photobook settings for images with photobook settings set up on another camera. All the photobook settings may be overwritten inadvertently.

Creative Filter Effects

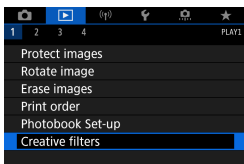

You can apply the following filter processing to an image and save it as a separate image: Grainy B/W, Soft focus, Fish-eye effect, Art bold effect, Water painting effect, Toy camera effect, and Miniature effect.

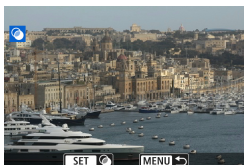

1 Select []: Creative filters].



2 Select an image.





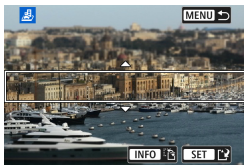

- Select an image with , then press .
- You can press the  button to select the image using the index display.



3 Select a filter effect (362).



4 Adjust the filter effect.

- Adjust the filter effect, then press .
- For the Miniature effect, press the     keys to move the white frame indicating the area that looks sharp, then press .

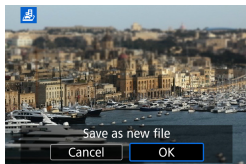

5 Save the image.

- Select **[OK]**.
- Check the destination folder and image file number displayed, then select **[OK]**.
- To apply filter processing to other images, repeat steps 2–5.



- For images captured in RAW+JPEG shooting, filter processing is applied to the RAW image, and the results are saved as a JPEG.
- For RAW images captured at a specific aspect ratio, the resulting image is saved at that aspect ratio after filter processing.
- Images processed using the fish-eye effect filter will not have Dust Delete Data (📖 241) appended.

Creative Filter Characteristics

● 📷 Grainy B/W

Makes the image grainy and black and white. By adjusting the contrast, you can change the black-and-white effect.

● 👤 Soft focus

Gives the image a soft look. By adjusting the blur, you can change the degree of softness.

-  **Fish-eye effect**

Gives the effect of a fish-eye lens. The image will have barrel distortion. Depending on the level of this filter effect, the area trimmed along the periphery of the image changes. Also, because this filter effect magnifies the center of the image, the apparent resolution at the center may degrade depending on the number of recorded pixels, so set the filter effect in step 4 while checking the resulting image.

-  **Art bold effect**

Makes the photo look like an oil painting and the subject look more three-dimensional. By adjusting the effect, you can change the contrast and saturation. Note that subjects such as the sky or white walls may not be rendered with a smooth gradation and may look irregular or have significant noise.

-  **Water painting effect**

Makes the photo look like a watercolor painting with soft colors. By adjusting the effect, you can change the color density. Note that night scenes or dark scenes may not be rendered with a smooth gradation and may look irregular or have significant noise.

-  **Toy camera effect**

Shifts colors to those typical of toy cameras and darkens the four corners of the image. Color tone options can be used to change the color cast.

-  **Miniature effect**

Creates a diorama effect. You can change where the image looks sharp. To switch between vertical and horizontal orientation of the sharp area (white frame), press the <INFO> button in step 4 (or tap [INFO] on the screen).

RAW Image Processing



You can process **RAW** or **CRAW** images with the camera to create JPEG images. RAW images are not affected, so different conditions can be applied to create JPEGs.

You can also use Digital Photo Professional (EOS software) to process RAW images.

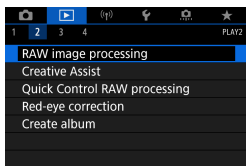

- 1 Select []: RAW image processing].

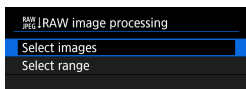

- 2 Select an item, then select images.
 - You can select multiple images to process at once.

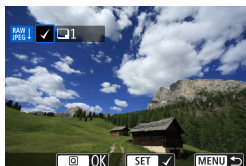

Select images

- Turn the dial to select images to process, then press .
- Press the button.

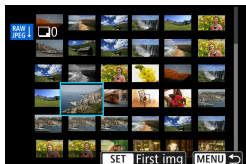

Select range

- Select the first image (start point).
- Next, select the last image (end point).
- Press the button.

3 Set the desired processing conditions.

Use shot settings

- Images are processed using image settings at the time of capture.

Customize RAW processing

- Select an item with < [Function] > < [Function] >.
- Turn the < [Dial] > or < [Dial] > dial to switch the setting.
- Press < [SET] > to access the function setting screen.
- To return to the image settings at the time of shooting, press the < [Trash] > button.

Comparison screen

- You can switch between the **[After change]** and **[Shot settings]** screens by pressing the < [INFO] > button and turning the < [Dial] > dial.
- Items in orange on the **[After change]** screen have been modified since the time of capture.
- Press the < [MENU] > button.



4 Save the image.

- When using **[Customize RAW processing]**, select < [Save] >.
- Read the message and select **[OK]**.
- To process other images, select **[Yes]** and repeat steps 2–4.

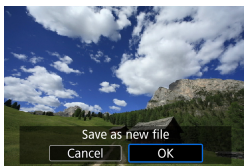



- 5 Select the image to display.**
- Select **[Original image]** or **[Processed img.]**.

Magnified View

You can magnify images displayed for **[Customize RAW processing]** by pressing the **<⌕>** button. Magnification varies depending on the **[Image quality]** setting. With **<⌕>** **<⌕>**, you can scroll around the magnified image.

To cancel the magnified view, tap **[↶]** or press the **<⌕>** button.















Processing Images with Specified Aspect Ratios

JPEG images at the specified aspect ratio are created when you process RAW images shot with **[📷: Still img aspect ratio]** (📖 202) set to an option other than **[3:2]**.



- Some settings cannot be changed when multiple-exposure **RAW** or **CRRAW** images are processed.

RAW Image Processing Options

- **[:±0] Brightness adjustment**
You can adjust the image brightness up to ±1 stop in 1/3-stop increments.
- **[] White balance ( 222)**
You can select the white balance. If you select [, you can select [**Auto: Ambience priority**] or [**Auto: White priority**]. If you select [, you can set the color temperature.
- **[] Picture Style ( 230)**
You can select the Picture Style. You can adjust the sharpness, contrast, and other parameters.
- **[] Auto Lighting Optimizer ( 218)**
You can set the Auto Lighting Optimizer.
- **[] High ISO speed noise reduction ( 239)**
You can set the noise reduction processing for high ISO speeds. If the effect is difficult to discern, magnify the image ( 336).
- **[] Image quality ( 199)**
You can set the image quality when creating a JPEG image.

- **[sRGB] Color space** (📖 229)

You can select either sRGB or Adobe RGB. Since the camera screen is not compatible with Adobe RGB, the difference in the image will hardly be perceptible when either color space is set.

- **[📐] Lens aberration correction**

- **[☐OFF] Peripheral illumination correction** (📖 207)

A phenomenon that makes the image corners look darker due to the lens characteristics can be corrected. If **[Enable]** is set, the corrected image will be displayed. If the effect is difficult to discern, magnify the image (📖 336) and check the four corners. The peripheral illumination correction applied with the camera will be less pronounced than that applied with the Digital Photo Professional (EOS software) at maximum correction amount. If the effects of correction are not apparent, use Digital Photo Professional to apply the peripheral illumination correction.

- **[📐OFF] Distortion correction** (📖 207)

Image distortion due to lens characteristics can be corrected. If **[Enable]** is set, the corrected image will be displayed. The image periphery will be trimmed in the corrected image.

Since the image resolution may look slightly lower, adjust the sharpness with the Picture Style's **[Sharpness]** parameter setting as necessary.

- **[☐OFF] Digital Lens Optimizer** (📖 208)

Correct lens aberration, diffraction, and low-pass filter-induced loss of sharpness by applying optical design values. Selecting **[Enable]** corrects both chromatic aberration and diffraction, although these options are not displayed.

-  **Chromatic aberration correction** (📖 209)

Chromatic aberrations (color fringing along the subject's outline) due to the lens characteristics can be corrected. If **[Enable]** is set, the corrected image will be displayed. If the effect is difficult to discern, magnify the image (📖 336).

-  **Diffraction correction** (📖 209)

The diffraction by the lens aperture degrading the image sharpness can be corrected. If **[Enable]** is set, the corrected image will be displayed. If the effect is difficult to discern, magnify the image (📖 336).



- Processing RAW images in the camera will not produce exactly the same results as processing RAW images with Digital Photo Professional (EOS software).
- If you perform **[Brightness adjustment]**, noise, banding, etc. may be intensified with the effects of adjustment.
- When **[Digital Lens Optimizer]** is set, noise may be intensified together with the effects of correction. Image edges may also be emphasized. Adjust Picture Style sharpness or set **[Digital Lens Optimizer]** to **[Disable]**, as needed.



- The effect of the lens aberration correction varies depending on the lens used and shooting conditions. Also, the effect may be difficult to discern depending on the lens used, shooting conditions, etc.

Processing With Your Preferred Effects Applied (Creative Assist)

You can process RAW images by applying your preferred effects and saving as JPEGs.

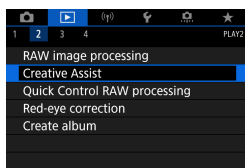

1 Select []: Creative Assist].



2 Select an image.

- Turn the dial to select images to process, then press .



3 Select an effect level.

- Use the keys to select the effect.



- By selecting [**Preset**] and pressing , you can choose [**VIVID**], [**SOFT**], or other preset effects. [**AUTO1**], [**AUTO2**], and [**AUTO3**] are effects recommended by the camera based on image conditions.



- You can select effects such as **[Brightness]** or **[Contrast]** by pressing <SET> and then using the <◀> <▶> keys.
- Press <SET> when adjustment is finished.



- To reset the effect, press the <✱> button.
- To confirm the effect, press the <⏎> button.

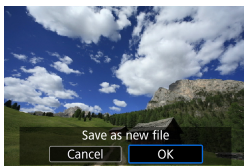

4 Select [OK] to save the image.

Selecting the Type of RAW Image Processing

You can select the type of RAW image processing performed from the Quick Control screen.

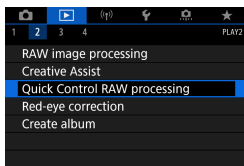

1 Select []: Quick Control RAW processing].

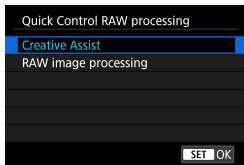

2 Select an item.

- **Creative Assist**

RAW processing that applies your preferred effect (370).

- **RAW image processing**

RAW processing according to conditions you specify (364).

Red-Eye Correction

Automatically corrects relevant portions of images affected by red-eye. The image can be saved as a separate file.

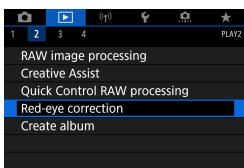

1 Select []: Red-eye correction].

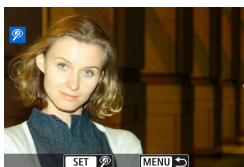

2 Select an image with .

- After image selection, either touch [] or press $\langle \text{SET} \rangle$.
- White frames are displayed around corrected image areas.

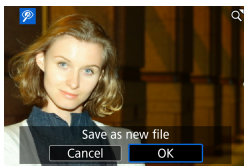

3 Select [OK].

- The image is saved as a separate file.



- Some images may not be corrected accurately.

Editing Video Snapshot Albums

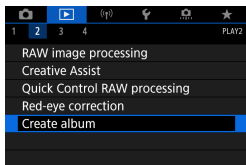

1 Select []: Create album].



2 Select an album to edit.

- Press <SET> to add a checkmark [✓].
- After selection, press the <Q> button.



3 Select an editing option.

Option	Description
↔ Rearrange video snapshots	Turn the <⌚> dial to select a video snapshot to move, then press <SET>. Turn the <⌚> dial to move it, then press <SET>.
🗑 Remove video snapshot	Turn the <⌚> dial to select a video snapshot to delete, then press <SET>. Selected video snapshots are labeled [🗑]. To clear the selection and remove [🗑], press <SET> again.
▶ Play video snapshot	Turn the <⌚> dial to select a video snapshot to play, then press <SET>. Use the <▲> <▼> keys to adjust the volume.



4 Finish editing.

- Press the <MENU> button when you are finished editing.
- Select [↔] (Finish editing).

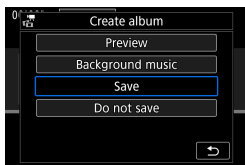

5 Save the image.

- To play an album with background music, use [**Background music**] to select the music (📖 376).
- To check your editing, select [**Preview**].
- Selecting [**Save**] saves the edited album as a new album.





- Video snapshot albums can only be edited once.

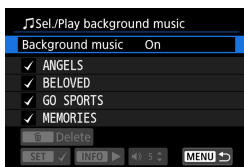

Selection of Background Music

Albums and slideshows can be played with background music once you copy the music to the card, using EOS Utility (EOS software).



- 1 **Select [Background music].**
 - Set [Background music] to [On].

- 2 **Select the background music.**
 - Turn the <  > dial to select the music, then press <  >. For [Slide show], you can select multiple tracks.

- 3 **Listen to a sample.**
 - To listen to a sample, press the <INFO> button.
 - Use the <▲> <▼> keys to adjust the volume. Press the <INFO> button again to stop playback.
 - To delete the music, turn the <  > dial to select it, then press the <  > button.



- For instructions on copying background music to cards, refer to the EOS Utility Instruction Manual.

Cropping JPEG Images

You can crop a captured JPEG image and save it as another image.

Cropping an image is possible only with JPEG images. Images shot in RAW cannot be cropped.

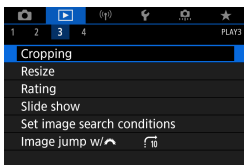

1 Select []: Cropping].

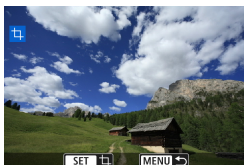

2 Select an image.

- Turn the  dial to select the image you want to crop.





3 Set the cropping frame.

- Press  to display the cropping frame.
- The image area within the cropping frame will be cropped.

● Changing the Cropping Frame Size

Press the  button to change the cropping frame size. The smaller the cropping frame, the more magnified the cropped image will look.

● Changing the Aspect Ratio and Orientation

Turn the  dial to select . Press  to change the cropping frame's aspect ratio.

● Moving the Cropping Frame

Use <⊕> <⊖> to move the frame vertically or horizontally. Move the cropping frame until it covers the desired image area.

● Correcting the Tilt

You can correct image tilt by $\pm 10^\circ$. Turn the <⊙> dial to select <⏏>, then press <SET>. While checking the tilt against the grid, turn the <⊙> dial (in 0.1° increments) or tap the left or right wedge (in 0.5° increments) on the upper left of the screen to correct the tilt. After completing the tilt correction, press <SET>.



4 Check the image area to be cropped.

- Turn the <⊙> dial to select <⏏>. The image area to crop is displayed.

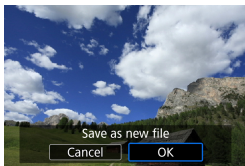

5 Save the image.

- Turn the <⊙> dial to select <⏏>.
- Select **[OK]** to save the cropped image.
- Check the destination folder and image file number, then select **[OK]**.
- To crop another image, repeat steps 2 to 5.

- The position and size of the cropping frame may change depending on the angle set for tilt correction.
- Once a cropped image is saved, it cannot be cropped again or resized.
- AF point display information (📖 392) and Dust Delete Data (📖 241) will not be appended to the cropped images.

Resizing JPEG Images

You can resize a JPEG image to make the pixel count lower and save it as a new image. Resizing an image is possible only with JPEG **L**, **M**, and **S1** images. JPEG **S2** and RAW images cannot be resized.

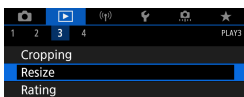

1 Select []: Resize].

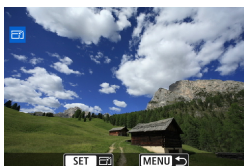

2 Select an image.

- Turn the  dial to select the image you want to resize.



3 Select the desired image size.

- Press  to display the image sizes.
- Select the desired image size (1).

(1)

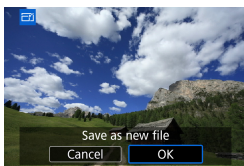

4 Save the image.

- Select [**OK**] to save the resized image.
- Check the destination folder and image file number, then select [**OK**].
- To resize another image, repeat steps 2 to 4.



● For details on image sizes of resized images, see  621.

Image Ratings

You can rate images on a scale of 1–5 ([*]/[*]/[*:]/[*:]/[*:]). This function is called rating.

* Rating images can help you organize them.

Rating a Single Image

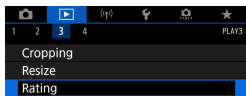

1 Select []: Rating].

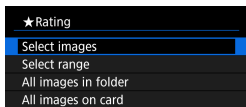

2 Select [Select images].



3 Select the image to be rated.

- Turn the < > dial to select the image to be rated.



4 Rate the image.

- Press < >, and a blue highlight frame will appear as shown in the screen shown on the left.
- Use the < > < > keys to select a rating mark, then press < >.
- When you append a rating mark to the image, the number beside the set rating will increase by one.
- To rate another image, repeat steps 3 and 4.

Rating by Specifying the Range

While looking at the images in the index display, you can specify the first and last images for a range to rate all the specified images at once.

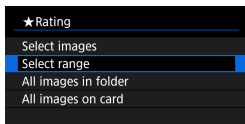

1 Select [Select range].

- Select [Select range] in [▶]: Rating].

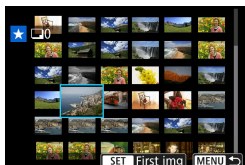

2 Specify the range of images.

- Select the first image (start point).
- Next, select the last image (end point).
A checkmark [✓] will be appended to all the images within the range between first and last images.

3 Press the <Q> button.

4 Rate the image.

- Turn the <Q> dial to select a rating mark, then select [OK].
All the images in the specified range will be rated (same rating) at once.



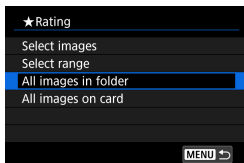

Rating All Images in a Folder or on a Card

You can rate all the images in a folder or on a card at once.

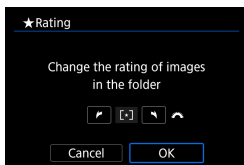

Under [**▶**]: **Rating**], when you select [**All images in folder**] or [**All images on card**], all the images in the folder or on the card will be rated.



Turn the <  > dial to select a rating, then select [**OK**].

When you are not rating images or cancelling the rating, select [**OFF**].

If the search conditions are set with [**▶**]: **Set image search conditions**] ( 385), the display will change to [**All found images**].



If you select [**All found images**], all the images filtered by the search conditions will be rated as specified.

- Values next to ratings are displayed as **###** if more than 1,000 images have that rating.
- With [**▶**]: **Set image search conditions**] and [**▶**]: **Image jump w/ **], you can display only the images given a specific rating.

Image Slide Shows (Auto Playback)

You can play back the images on the card as an automatic slide show.

1 Specify the images to be played back.

- To play back all the images on the card, go to step 2.
- If you want to specify the images to be played back in the slide show, filter the images with [▶]: **Set image search conditions** (📖 385).

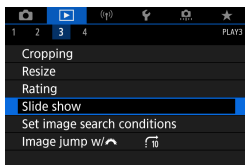

2 Select [▶]: Slide show].

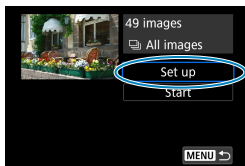

3 Set the playback as desired.

- Select [Set up].
- Set the [Display time], [Repeat] (repeated playback), and [Transition effect] (effect when changing images) for the still photos.
- To play background music, use [Background music] to select the music (📖 376).
- After completing the settings, press the <MENU> button.

Display time

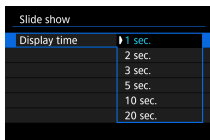

Repeat

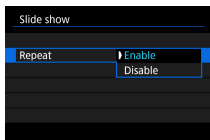

Transition effect

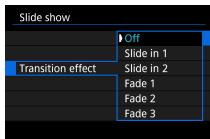

Background music

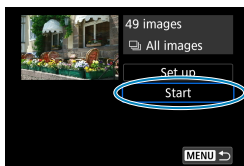
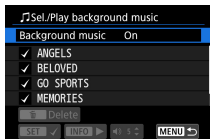

4 Start the slide show.

- Select **[Start]**.
After **[Loading image...]** is displayed, the slide show will start.

5 Exit the slide show.

- To exit the slide show and return to the setting screen, press the **<MENU>** button.

- To pause the slide show, press **<SET>**. During pause, **[||]** will be displayed on the upper left of the image. Press **<SET>** again to resume the slide show.
- During the automatic playback of still photos, you can press the **<INFO>** button to switch the display format (332).
- Volume during movie playback can be adjusted by turning the **<▲>** **<▼>** keys.
- During auto playback or pause, you can turn the **<◉>** dial to view another image.
- During auto playback, auto power off will not take effect.
- The display time may differ depending on the image.

Filtering Images for Playback

You can filter image display according to your search conditions. After setting the image search conditions, you can play back and display only the found images.

You can also protect, rate, erase, play a slide show, and apply other operations to filtered images.

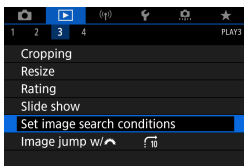



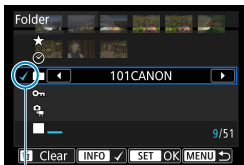

1 Select []: Set image search conditions].



(1)

2 Set the search conditions.

- Turn the < > dial to select an item.
- Turn the < > dial to set the setting.
- A checkmark [] (1) is appended to the left of the item. (Specified as the search condition.)
- If you select the item and press the <INFO> button, the checkmark [] will be removed. (The search condition is canceled.)

Item	Description
★ Rating	Displays images with the selected (rating) condition.
☑ Date	Displays images taken on the selected shooting date.
📁 Folder	Displays images in the selected folder.
🔒 Protect	Displays images with the selected (protect) condition.
📁 Type of file	Displays images in the selected file type.

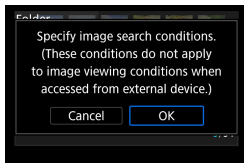

- 3 Apply the search conditions.**
- Press < **SET** > and read the message displayed.
 - Select **[OK]**.
The search condition is specified.

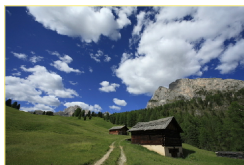

(2)

- 4 Display the found images.**
- Press the < **[▶]** > button.
Only the images that match the set conditions (filtered) will be played back. When the images are filtered for display, the screen will have an outer yellow frame (2).

Clearing the Search Conditions

Access the screen in step 2, then press the < **[⏏]** > button to clear all the search conditions.

- If no images match the search conditions, < **SET** > cannot be pressed in step 3.

- Search conditions may be cleared if you perform power, card, or image editing operations.
- Auto power off time may be extended while the **[▶]: Set image search conditions** screen is displayed.

Jump Display (Jumping Through Images)

In the single-image display, you can turn the <  > dial to jump through the images forward or backward according to the jump method set.

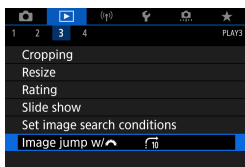



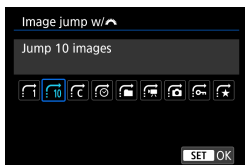

1 Select [: Image jump w/ ].



2 Select the jump method.



- With [**Jump images by the specified number**], you can turn the <  > dial to select the number of images to jump by.
- When you select [**Display by image rating**], turn the <  > dial to specify the rating ( 380). If you browse images with  selected, all the rated images will be displayed.

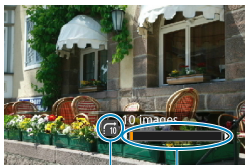

(1)

(2)

3 Browse by jumping.

- Press the <▶> button.
- In the single-image display, turn the <⚙> dial.
You can browse by the set method.

(1) Jump method

(2) Playback position



- To search images by shooting date, select [: **Date**].
- To search images by folder, select [: **Folder**].
- If the card contains both movies and still photos, select [: **Movies**] or [: **Stills**] to display one or the other.

Customizing Playback Information Display

You can specify screens and accompanying information displayed during image playback.

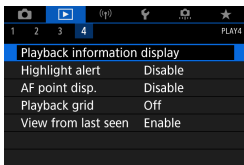

1 Select []: Playback information display].

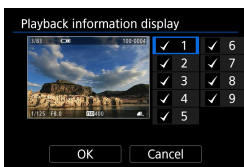

2 Add a checkmark [] next to the number of screens to display.

- Select numbers with .
- Press to add a checkmark [].
- Repeat these steps to add a checkmark [] to the number of each screen to display, then select [**OK**].
- Your selected information can be accessed by pressing the **<INFO>** button during playback, or by using the **<▲>** **<▼>** keys when shooting information is displayed.

Histogram

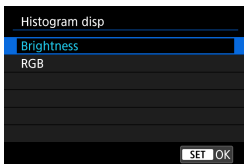

The brightness histogram shows the exposure level distribution and overall brightness. The RGB histogram is for checking the color saturation and gradation. You can switch the histogram displayed by pressing the **<INFO>** button when **<INFO>** is displayed in the lower left of the []: **Playback information display**] screen.

● [Brightness] display

This histogram is a graph showing the distribution of the image's brightness level. The horizontal axis indicates the brightness level (darker on the left and brighter on the right) while the vertical axis indicates how many pixels exist for each brightness level. The more pixels there are toward the left, the darker the image. The more pixels there are toward the right, the brighter the image. If there are too many pixels on the left, the shadow detail will be lost. If there are too many pixels on the right, the highlight detail will be lost. The gradation in-between will be reproduced. By checking the image and its brightness histogram, you can see the exposure level inclination and the overall gradation.

Sample Histograms

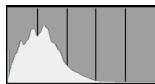

Dark image

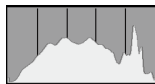

Normal brightness



Bright image

● [RGB] display

This histogram is a graph showing the distribution of each primary color's brightness level in the image (RGB or red, green, and blue). The horizontal axis indicates the color's brightness level (darker on the left and brighter on the right), while the vertical axis indicates how many pixels exist for each color brightness level. The more pixels there are toward the left, the darker and less prominent the color. The more pixels there are toward the right, the brighter and denser the color. If there are too many pixels on the left, the respective color information will be lacking. If there are too many pixels on the right, the color will be too saturated with no gradation. By checking the image's RGB histogram, you can see the color's saturation and gradation condition, as well as white balance inclination.

Displaying the Highlight Alert

You can specify blinking display of overexposed highlights on the playback screen. To obtain more detailed gradation in the blinking areas where you want the gradation to be faithfully reproduced, set the exposure compensation to a negative amount and shoot again for a better result.

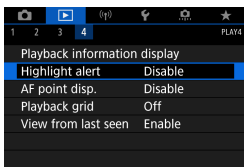

1 Select []: Highlight alert].

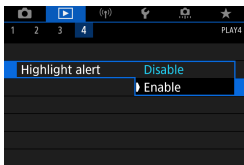

2 Select [Enable].

AF Point Display

You can display the AF points that were used to focus, which will be outlined in red on the playback screen. If automatic AF point selection is set, multiple AF points may be displayed.

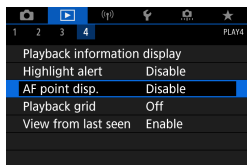

1 Select [: AF point disp.].

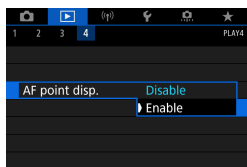

2 Select [Enable].

Grid Display

You can display a grid over still photos shown in single-image display on the playback screen. This function is convenient for checking the image's vertical or horizontal tilt as well as composition.

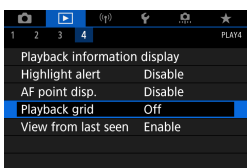

1 Select []: Playback grid].

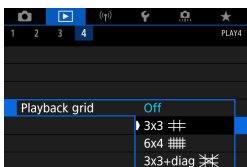

2 Select an item.

Specifying Initial Image Display When Playback Begins

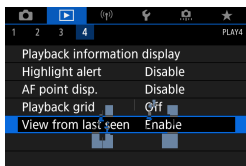

1 Select [▶]: View from last seen].

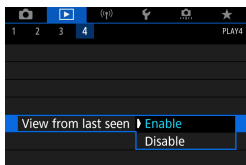

2 Select an item.

- **[Enable]**: Playback resumes from the last image displayed (except when you have just finished shooting).
- **[Disable]**: Playback resumes from your most recent shot whenever the camera is restarted.

Wireless Features

This chapter describes how to connect the camera to a smartphone wirelessly via Bluetooth® or Wi-Fi® and send images to devices or Web services, how to control the camera from a computer or wireless remote control, and other operations.



Important

Note that Canon cannot be held liable for any loss or damage from erroneous wireless communication settings when using the camera. In addition, Canon cannot be held liable for any other loss or damage caused by use of the camera.

When using wireless communication functions, establish appropriate security at your own risk and discretion. Canon cannot be held liable for any loss or damage caused by unauthorized access or other security breaches.

Tab Menus: Wireless Tab

● Wireless 1

1		NETWORK
Wi-Fi/Bluetooth connection		397
Wi-Fi settings	Enable	470
Bluetooth settings	Enable	471
Nickname		472
GPS device settings		473
Clear wireless settings		480

- Wireless communication is not available while the camera is connected via an interface cable to a computer or other device.
- Other devices, such as computers, cannot be used with the camera by connecting them with an interface cable while the camera is connected to devices via Wi-Fi.
- The camera cannot be connected via Wi-Fi if there is no card in the camera (except for []). Also, for [] and Web services, the camera cannot be connected via Wi-Fi if there are no images saved on the card.
- The Wi-Fi connection will be terminated if you set the camera's power to <OFF>, or open the card slot/battery compartment cover.
- With a Wi-Fi connection established, the camera's auto power off does not function.

Selection of Wi-Fi/Bluetooth Connection

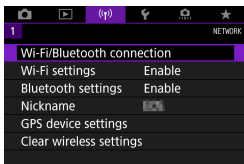

1 Select [(Wi-Fi/Bluetooth icon)]: Wi-Fi/Bluetooth connection].

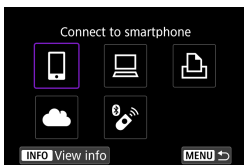

2 Select an item for the camera to connect to.

Connect to smartphone (439)

Control the camera remotely and browse images on the camera over a Wi-Fi connection by using the dedicated Camera Connect app on smartphones or tablets (collectively referred to as “smartphones” in this manual).

Use with EOS software or other dedicated software (426)

Connect the camera to a computer via Wi-Fi and operate the camera remotely using EOS Utility (EOS software). With the dedicated application Image Transfer Utility 2, images on the camera can also be sent to a computer automatically.

Print from Wi-Fi printer (434)

Connect the camera to a printer supporting PictBridge (Wireless LAN) via Wi-Fi to print images.

Upload to Web service (📖 444)

Share images with friends or family on social media or the CANON iMAGE GATEWAY online photo service for Canon customers after you complete member registration (free of charge).

Connect to Wireless Remote

This camera can also be connected to Wireless Remote Control BR-E1 (sold separately) via Bluetooth for remote control shooting (📖 464).

Connecting to a Smartphone

You can do the following after pairing the camera with a smartphone compatible with Bluetooth low energy technology (hereafter, “Bluetooth”).

- Establish a Wi-Fi connection using only the smartphone (📖 400).
- Establish a Wi-Fi connection with the camera even when it is off (📖 405).
- Geotag images with GPS information acquired by the smartphone (📖 475).
- Control the camera remotely from a smartphone (📖 404).

You can also do the following after connecting the camera to a smartphone via Wi-Fi.

- Browse and save images on the camera from a smartphone (📖 404).
- Control the camera remotely from a smartphone (📖 404).
- Send images to a smartphone from the camera (📖 413).

Turning on Bluetooth and Wi-Fi on a Smartphone

Turn on Bluetooth and Wi-Fi from the smartphone settings screen. Note that pairing with the camera is not possible from the smartphone’s Bluetooth settings screen.



- To establish a Wi-Fi connection via an access point, see “Wi-Fi Connection via Access Points” (📖 458).

Installing Camera Connect on a Smartphone

The dedicated app Camera Connect (free of charge) must be installed on the smartphone on which Android or iOS is installed.

- Use the latest version of the smartphone OS.
- Camera Connect can be installed from Google Play or App Store. Google Play or App Store can also be accessed using the QR codes that appear when the camera is paired or connected via Wi-Fi to a smartphone.



- For the operating system versions supported by Camera Connect, refer to the download site of Camera Connect.
- Sample screens and other details in this guide may not match the actual user interface elements after camera firmware updates or updates to Camera Connect, Android, or iOS.

Connecting to a Bluetooth-compatible Smartphone via Wi-Fi

Steps on the Camera (1)

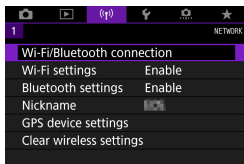

1 Select [(Wi-Fi/Bluetooth connection)].

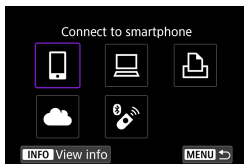

2 Select [Smartphone Connect to smartphone].

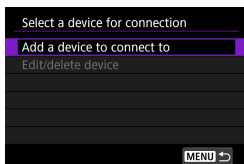

3 Select [Add a device to connect to].

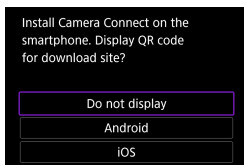

4 Select an item.

- If Camera Connect is already installed, select [**Do not display**].
- If Camera Connect is not installed, select [**Android**] or [**iOS**], scan the displayed QR code with the smartphone to access Google Play or App Store and install Camera Connect.

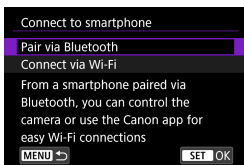

5 Select [Pair via Bluetooth].

- Pairing now begins.



- To pair with a different smartphone after pairing with one initially, select [OK] on the screen at left.

Steps on the Smartphone (1)



6 Start Camera Connect.

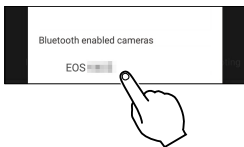

7 Tap the camera for pairing.

- If you are using an Android smartphone, go to step 9.

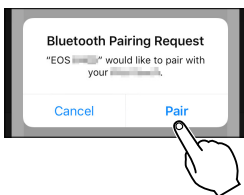

8 Tap on [Pair] (iOS only).

Steps on the Camera (2)



9 Select [OK].

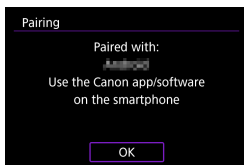

10 Press <SET>.

- Pairing is now complete, and the camera is connected to the smartphone via Bluetooth.

A Bluetooth icon appears on the main Camera Connect screen.

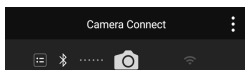

- The camera cannot be connected to two or more devices at the same time via Bluetooth. To switch to a different smartphone for the Bluetooth connection, see 478.
- Bluetooth connection consumes battery power even after the camera's auto power off is activated. Therefore, the battery level may be low when you use the camera.

Troubleshooting Pairing

- Keeping pairing records for previously paired cameras on your smartphone will prevent it from pairing with this camera. Before you try pairing again, remove pairing records for previously paired cameras from your smartphone's Bluetooth settings screen.

- With a Bluetooth connection established, you can operate the camera to send images to the smartphone (413).

Steps on the Smartphone (2)

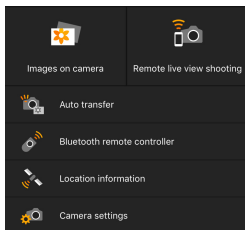

11 Tap on a Camera Connect function.

- In iOS, tap **[Join]** when a message is displayed to confirm camera connection.
- For the Camera Connect functions, see 404.
- When a Wi-Fi connection is established, the screen for the selected function will appear.

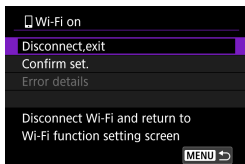

- **[Wi-Fi on]** is displayed on the camera.
- The Bluetooth and Wi-Fi icons are lit on the main Camera Connect screen.

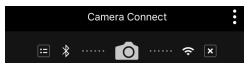

The Wi-Fi connection to a Bluetooth-compatible smartphone is now complete.

- For how to terminate the Wi-Fi connection, see “Terminating Wi-Fi Connections” (421).
- Terminating the Wi-Fi connection will switch the camera to the Bluetooth connection.
- To reconnect via Wi-Fi, start Camera Connect and tap the function you will use.

[Wi-Fi on] Screen

Disconnect,exit

- Terminates the Wi-Fi connection.

Confirm set.

- You can check the settings.

Error details

- When a Wi-Fi connection error occurs, you can check the details of the error.

Camera Connect Functions

Images on camera

- Images can be browsed, deleted, or rated.
- Images can be saved on a smartphone.

Remote live view shooting

- Enables remote shooting as you view a live image on the smartphone.

Auto transfer

- Enables camera and app setting adjustment to send shots to a smartphone automatically as they are captured (📖 412).

Bluetooth remote controller

- Enables remote control of the camera from a smartphone paired via Bluetooth. (Not available when connected via Wi-Fi.)
- Auto power off is disabled while you are using the Bluetooth remote controller feature.

Location information

- Not supported on this camera.

Camera settings

- Camera settings can be changed.

Maintaining a Wi-Fi Connection When the Camera Is Off

Even when the camera power switch is set to <OFF>, as long as it is paired to a smartphone via Bluetooth, you can use the smartphone to connect via Wi-Fi.

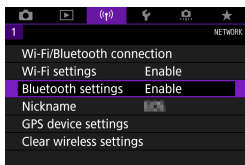

1 Select [(Ⓛ): Bluetooth settings].

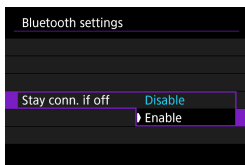

2 Set [Stay conn. if off] to [Enable].

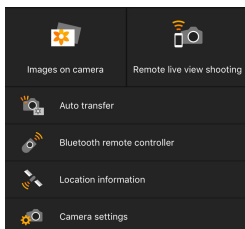

- With the camera power switch set to <OFF>, tap [**Images on camera**] in the Camera Connect menu to start the Wi-Fi connection.
- In iOS, tap [**Join**] when a message is displayed to confirm camera connection. Images on the camera are listed when the Wi-Fi connection is established.

- You can use Camera Connect to save images to the smartphone, and you can delete images on the camera.
- To terminate the Wi-Fi connection, tap on [(✕)] on the main Camera Connect screen (📖 421).



- This function can no longer be used if the wireless settings are reset or the smartphone connection information is erased.

Canceling the Pairing

Cancel pairing with a smartphone as follows.

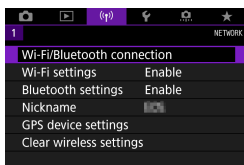

1 Select [**(P)**: Wi-Fi/Bluetooth connection].

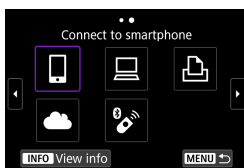

2 Select [**☎** Connect to smartphone].
● If the history (📖 467) is displayed, switch the screen with the <◀> <▶> keys.

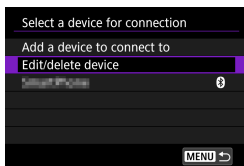

3 Select [Edit/delete device].

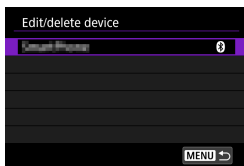

4 Select the smartphone to cancel pairing with.
● Smartphones currently paired with the camera are labeled [**☎**].

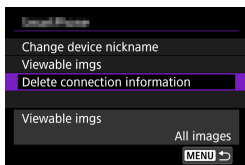

5 Select [Delete connection information].

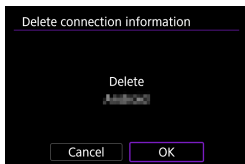

6 Select [OK].

7 Clear the camera information on the smartphone.

- In the smartphone's Bluetooth setting menu, clear the camera information registered on the smartphone.

Wi-Fi Connection Without Using Bluetooth

Steps on the Camera (1)

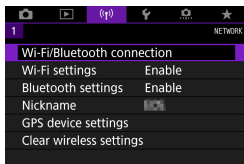

1 Select [(Ⓜ)]: **Wi-Fi/Bluetooth connection**].

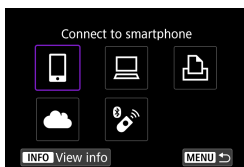

2 Select [ **Connect to smartphone**].

- If the history (📖 467) is displayed, switch the screen with the <◀> <▶> keys.

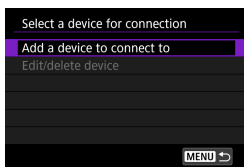

3 Select [**Add a device to connect to**].

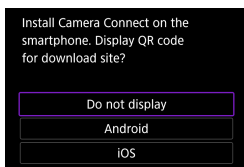

4 Select an item.

- If Camera Connect is already installed, select [**Do not display**].

5 Select [Connect via Wi-Fi].



6 Check the SSID (network name) and password.

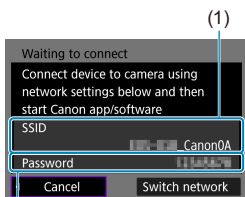

- Check the SSID (1) and password (2) displayed on the camera screen.
- In **[Wi-Fi settings]**, if you set **[Password]** to **[None]**, the password will not be displayed or required (📖470).

(2)



- By selecting **[Switch network]** in step 6, you can establish a Wi-Fi connection via an access point (📖458).

Steps on the Smartphone

Smartphone's screen (sample)



7 Operate the smartphone to establish a Wi-Fi connection.

- Activate the smartphone's Wi-Fi function, then tap the SSID (network name) checked in step 6.
- For the password, enter the password checked in step 6.

New camera found. Select camera to connect to.

8 Start Camera Connect and tap the camera to connect to via Wi-Fi.

Steps on the Camera (2)

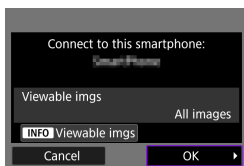

9 Select [OK].

- To specify viewable images, press the <INFO> button. See step 5 on 423 to set them.

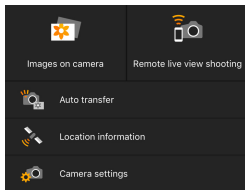

- The main window of Camera Connect will be displayed on the smartphone.

The Wi-Fi connection to a smartphone is now complete.

- Operate the camera using Camera Connect (📖 404).

- For how to terminate the Wi-Fi connection, see “Terminating Wi-Fi Connections” (📖 421).
- To reconnect via Wi-Fi, see “Reconnecting via Wi-Fi” (📖 467).



- When connected via Wi-Fi, you can send images to a smartphone from the Quick Control screen during playback (📖 413).

Automatic Image Transfer as You Shoot

Your shots can be automatically sent to a smartphone. Before following these steps, make sure the camera and smartphone are connected via Wi-Fi.

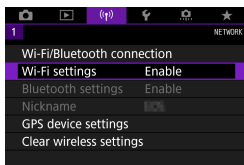

1 Select [(Wi-Fi): Wi-Fi settings].

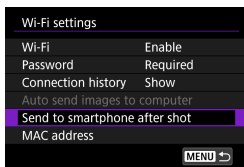

2 Select [Send to smartphone after shot].

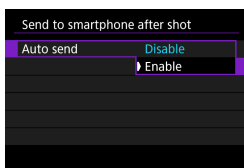

3 In [Auto send], select [Enable].

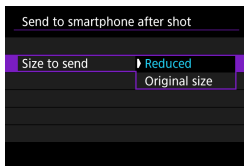

4 Set [Size to send].

5 Take the picture.

Sending Images to a Smartphone from the Camera

You can use the camera to send images to a smartphone paired via Bluetooth (Android devices only) or connected via Wi-Fi.



1 Play back the image.

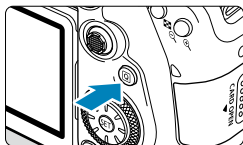

2 Press the <Q> button.

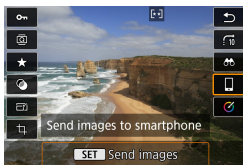

3 Select [☐ Send images to smartphone].

- If you perform this step while connected via Bluetooth, a message is displayed, and the connection switches to a Wi-Fi connection.

4 Select sending options and send the images.

(1) Sending Images Individually



1 Select an image to send.

- Press the <◀> <▶> keys or turn the <⦿> dial to select an image to send, then press <SET>.
- You can press the <⊠-Q> button to select the image using the index display.

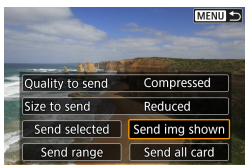

2 Select [Send img shown].

- In [Size to send], you can select the image sending size.
- When sending movies, you can select the image quality of movies to send in [Quality to send].

(2) Sending Multiple Selected Images

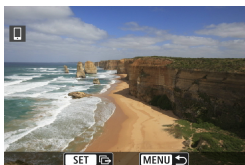

1 Press <SET>.

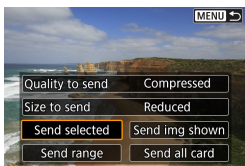

2 Select [Send selected].



3 Select images to send.

- Press the <◀▶> <▶▶> keys or turn the <⌚> dial to select images to send, then press <ⓈET>.

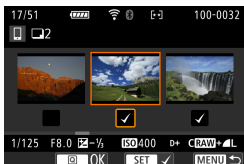

- You can press the <ⓈET><Q> button to select the images from 3-image display. To return to the single-image display, press the <Q> button.
- After selecting the images to send, press the <Q> button.

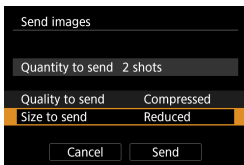

4 Select [Size to send].

- On the displayed screen, select an image size.

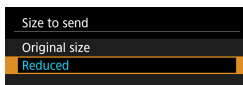

- When sending movies, select the image quality in [Quality to send].

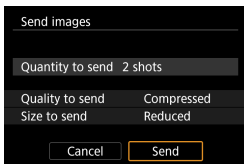

5 Select [Send].

(3) Sending a Specified Range of Images

1 Press <SET>.

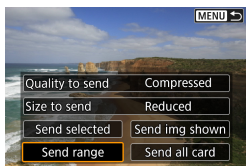

2 Select [Send range].



3 Specify the range of images.

- Select the first image (start point).
- Select the last image (end point).
- To cancel the selection, repeat this step.
- You can press the <[Grid Icon]> button to change the number of images shown in the index display.

4 Confirm the range.

- Press the <MENU> button.

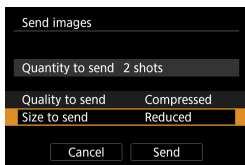

5 Select [Size to send].

- On the displayed screen, select an image size.

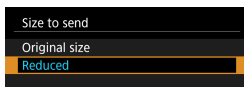

- When sending movies, select the image quality in [Quality to send].

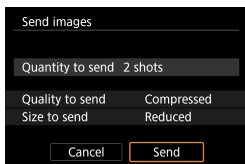

6 Select [Send].

(4) Sending All Images on the Card



1 Press < **SET** >.

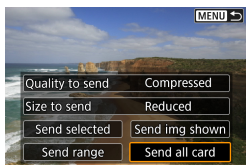

2 Select [**Send all card**].

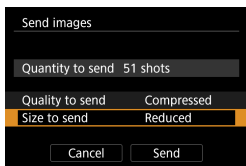

3 Select [**Size to send**].

- On the displayed screen, select an image size.



- When sending movies, select the image quality in [**Quality to send**].

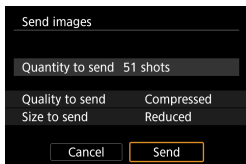

4 Select [**Send**].

(5) Sending Images that Match the Search Conditions

Send all the images that match the search conditions set in **[Set image search conditions]** at once.

For **[Set image search conditions]**, refer to “Filtering Images for Playback” (📖 385).



1 Press **<SET>**.

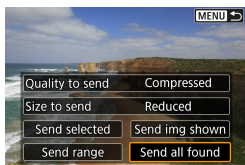

2 Select **[Send all found]**.

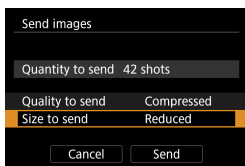

3 Select **[Size to send]**.

- On the displayed screen, select an image size.

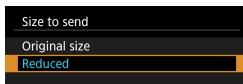

- When sending movies, select the image quality in **[Quality to send]**.

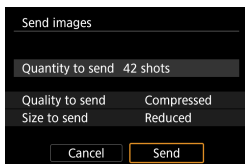

4 Select **[Send]**.

Ending Image Transfer

Sending Images from the Camera When Paired via Bluetooth (Android)



- Press the <MENU> button on the image transfer screen.

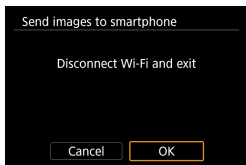

- Select [OK] on the screen on the left to end image transfer and the Wi-Fi connection.

Sending Images from the Camera over a Wi-Fi Connection



- Press the <MENU> button on the image transfer screen.
- To terminate the Wi-Fi connection, see "Terminating Wi-Fi Connections" (📖 421).



- During the image transfer operation, a picture cannot be taken even if the camera's shutter button is pressed.



- You can cancel the image transfer by selecting **[Cancel]** during the transfer.
- You can select up to 999 files at a time.
- With a Wi-Fi connection established, disabling the smartphone's power saving function is recommended.
- Selecting the reduced size for still photos applies to all still photos sent at that time. Note that **S2** size still photos are not reduced.
- Selecting compression for movies applies to all movies sent at that time.
- When you use a battery to power the camera, make sure it is fully charged.

Terminating Wi-Fi Connections

Perform either of the following operations.

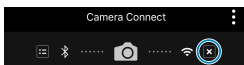

On the **Camera Connect** screen, tap on **[X]**.



On the **[Wi-Fi on]** screen, select **[Disconnect,exit]**.

- If the **[Wi-Fi on]** screen is not displayed, select **[Wi-Fi/Bluetooth connection]**.
- Select **[Disconnect,exit]**, then select **[OK]** on the confirmation dialog.

Settings to Make Images Viewable from Smartphones

Images can be specified after the Wi-Fi connection is terminated.

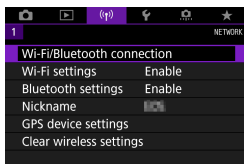

1 Select [(Wi-Fi/Bluetooth connection)].

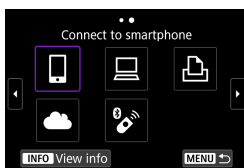

2 Select [Connect to smartphone].

- If the history (📖 467) is displayed, switch the screen with the <◀> <▶> keys.

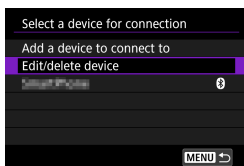

3 Select [Edit/delete device].

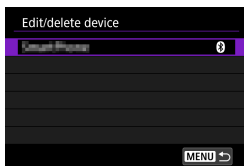

4 Select a smartphone.

- Select the name of the smartphone on which you want to make the images viewable.

5 Select [Viewable imgs].

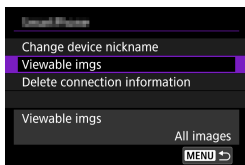

6 Select an item.

- Select [OK] to access the setting screen.

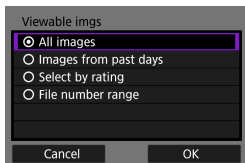

[All images]

All images stored on the card become viewable.

[Images from past days]

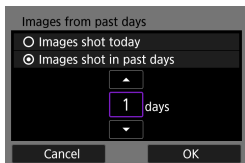

Specify viewable images on the shooting-date basis. Images shot up to nine days ago can be specified.

- When [Images shot in past days] is selected, images shot up to the specified number of days before the current date become viewable. Use the <▲> <▼> keys to specify the number of days, then press <SET> to confirm the selection.
- Once you select [OK], the viewable images are set.



- If [Viewable imgs] is set to any setting other than [All images], remote shooting is not possible.

[Select by rating]

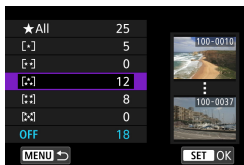

Specify viewable images depending on whether a rating is appended (or not appended) or by the type of rating.

- Once you select the type of rating, the viewable images are set.

[File number range] (Select range)

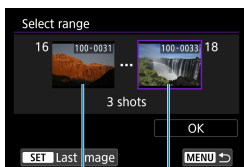

(1)

(2)

Select the first and last images from images arranged by the file number to specify the viewable images.

1. Press $\langle \text{SET} \rangle$ to display the image selection screen.
Select an image using the $\langle \blacktriangleleft \rangle \langle \blacktriangleright \rangle$ keys or $\langle \odot \rangle$ dial.
You can press the $\langle \text{Q} \rangle$ button to select the image using the index display.
2. Select an image as the starting point (1).
3. Use $\langle \blacktriangleright \rangle$ to select an image as the ending point (2).
4. Select **[OK]**.



- If the Wi-Fi connection is terminated while recording a movie with remote shooting, the following will occur.
 - If the Live View shooting/Movie shooting switch is set to , movie recording will continue.
 - If the Live View shooting/Movie shooting switch is set to , movie recording will stop.
- With a Wi-Fi connection to a smartphone established, certain functions are unavailable.
- In remote shooting, the AF speed may become slower.
- Depending on the communication status, image display or shutter release timing may be delayed.
- When saving images to a smartphone, you cannot take a picture even if you press the camera's shutter button. Also, the camera screen may turn off.



- With a Wi-Fi connection established, disabling the smartphone's power saving function is recommended.

Connecting to a Computer via Wi-Fi

This section describes how to connect the camera to a computer via Wi-Fi and perform camera operations using EOS software or other dedicated software. Install the latest version of software on the computer before setting up a Wi-Fi connection.

For computer operating instructions, refer to the computer user manual.

Operating the Camera Using EOS Utility

Using EOS Utility (EOS software), you can import images from the camera, control the camera, and perform other operations.

Steps on the Camera (1)

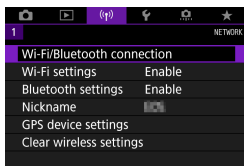

- 1 Select [**(Wi-Fi/Bluetooth icon)**: Wi-Fi/Bluetooth connection].

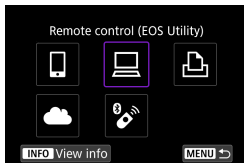

- 2 Select [**Remote control (EOS Utility icon)**].

- If the history (📖 467) is displayed, switch the screen with the <<> <>> keys.

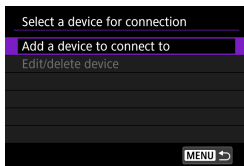

- 3 Select [**Add a device to connect to**].

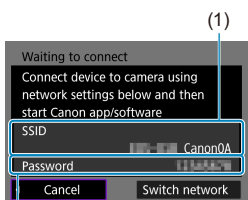

(2)

4 Check the SSID (network name) and password.

- Check the SSID (1) and password (2) displayed on the camera screen.
- In **[Wi-Fi settings]**, if you set **[Password]** to **[None]**, the password will not be displayed or required. For details, see [470](#).

Steps on the Computer (1) Computer's screen (sample)

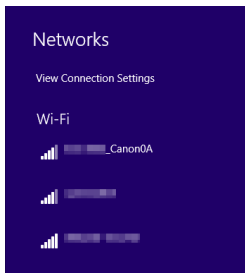

5 Select the SSID, then enter the password.

- On the computer's network setting screen, select the SSID checked in step 4.
- For the password, enter the password checked in step 4.

Steps on the Camera (2)

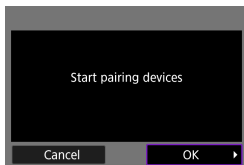

6 Select [OK].

- The following message is displayed. "*****" represents the last six digits of the MAC address of the camera to be connected.

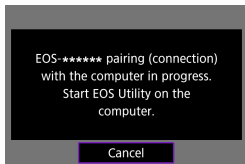

Steps on the Computer (2)

7 Start EOS Utility.

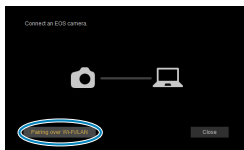

8 In EOS Utility, click [Pairing over Wi-Fi/LAN].

- If a firewall-related message is displayed, select [Yes].

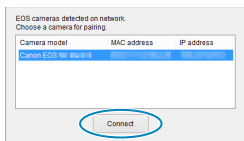

9 Click [Connect].

- Select the camera to connect to, then click [Connect].

Steps on the Camera (2)

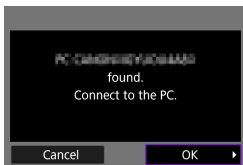

10 Establish a Wi-Fi connection.

- Select [OK].

[Wi-Fi on] Screen

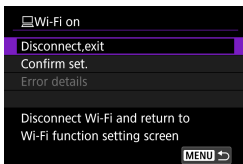

Disconnect,exit

- Terminates the Wi-Fi connection.

Confirm set.

- You can check the settings.

Error details

- When a Wi-Fi connection error occurs, you can check the details of the error.

The Wi-Fi connection to a computer is now complete.

- Operate the camera using EOS Utility on the computer.
- To reconnect via Wi-Fi, see “Reconnecting via Wi-Fi” (467).

- If the Wi-Fi connection is terminated while recording a movie with remote shooting, the following will occur.
 - If the Live View shooting/Movie shooting switch is set to <[📷]>, movie recording will continue.
 - If the Live View shooting/Movie shooting switch is set to <[📹]>, movie recording will stop.
- When the Live View shooting/Movie shooting switch is set to <[📷]> and the camera is set to the movie recording mode using EOS Utility, you cannot operate the camera to shoot.
- With a Wi-Fi connection to EOS Utility established, certain functions are unavailable.
- In remote shooting, the AF speed may become slower.
- Depending on the communication status, image display or shutter release timing may be delayed.
- In Remote Live View shooting, the rate of image transmission is slower compared to a connection via an interface cable. Therefore, moving subjects cannot be displayed smoothly.

Sending Images on the Camera Automatically

With the dedicated software Image Transfer Utility 2, you can send images on the camera to a computer automatically.

Steps on the Computer (1)

1 Connect the computer and access point and start Image Transfer Utility 2.

- The screen to set up pairing is shown when you follow the instructions displayed the first time Image Transfer Utility 2 starts up.

Steps on the Camera (1)

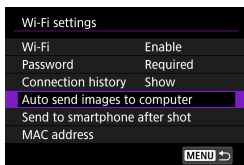

2 Select [Auto send images to computer].

- Select [(Wi-Fi): Wi-Fi settings].
- Select [Auto send images to computer].

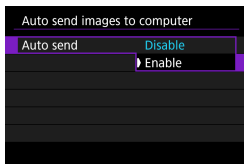

3 In [Auto send], select [Enable].

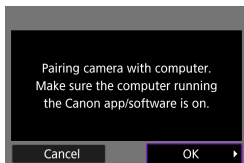

4 Select [OK].

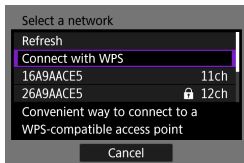

5 Connect to an access point via Wi-Fi.

- Establish a Wi-Fi connection between the camera and the access point connected to the computer. For connection instructions, see “Wi-Fi Connection via Access Points” (458).

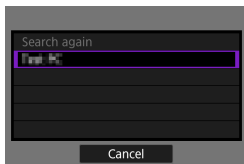

6 Select the computer to pair the camera with.

Steps on the Computer (2)

7 Pair the camera and computer.

- Select the camera, then click **[Pairing]**.

Steps on the Camera (2)

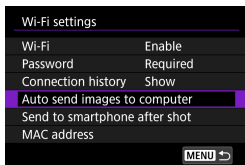

8 Select [Auto send images to computer].

- Select [(Wi-Fi icon): Wi-Fi settings].
- Select [Auto send images to computer].

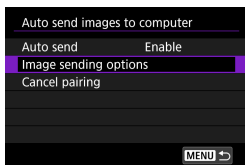

9 Select [Image sending options].

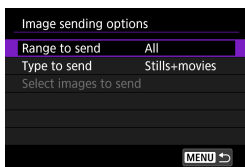

10 Select what to send.

- If you select [Selected imgs] in [Range to send], specify the images to send on the [Select images to send] screen.
- After the settings are complete, turn the camera off.

Images on the camera are automatically sent to the active computer when you turn the camera on within range of the access point.



- If images are not sent automatically, try restarting the camera.

Connecting to a Printer via Wi-Fi

This section describes how to print images by directly connecting the camera to a printer supporting PictBridge (Wireless LAN) via Wi-Fi. For printer operating instructions, refer to the printer user manual.

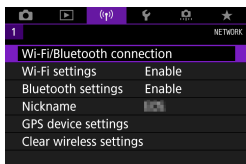

1 Select [**(Wi-Fi/Bluetooth connection)**].



2 Select [**Print from Wi-Fi printer**].

- If the history (467) is displayed, switch the screen with the <<> <>> keys.

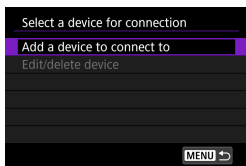

3 Select [**Add a device to connect to**].

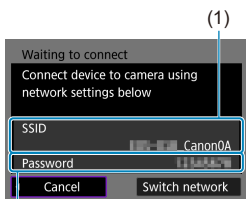

4 Check the SSID (network name) and password.

- Check the SSID (1) and password (2) displayed on the camera screen.
- In [**Wi-Fi settings**], if you set [**Password**] to [**None**], the password will not be displayed or required (470).

5 Set up the printer.

- On the Wi-Fi settings menu of the printer to be used, select the SSID you have checked.
- For the password, enter the password checked in step 4.

6 Select the printer.

- In the list of detected printers, select the printer to connect to via Wi-Fi.
- If your preferred printer is not listed, selecting **[Search again]** may enable the camera to find and display it.

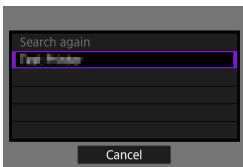

- To establish a Wi-Fi connection via an access point, see "Wi-Fi Connection via Access Points" (📖 458).

Image Printing

Printing Images Individually



1 Select the image to be printed.

- Press the <◀> <▶> keys or turn the <⦿> dial to select an image to print, then press <SET>.
- You can press the <⊞> button to select the image using the index display.



2 Select [Print image].

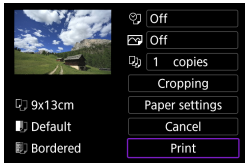

3 Print the image.

- For the print setting procedures, see 439.
- Select **[Print]**, then **[OK]** to start printing.

Printing According to Specified Image Options



1 Press **<SET>**.



2 Select **[Print order]**.

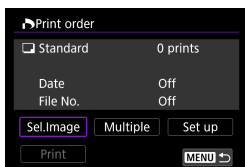

3 Set the printing options.

- For the setting procedures, refer to “Digital Print Order Format (DPOF)” (📖 354).
- If the print order is complete before establishing a Wi-Fi connection, go to step 4.

4 Select **[Print]**.

- **[Print]** can be selected only when an image is selected and the printer is ready to print.

5 Set the **[Paper settings]** (📖 439).

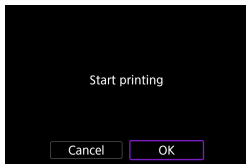

6 Print the image.

- When **[OK]** is selected, printing starts.



- Shooting is not possible while connected to a printer via Wi-Fi.
- Movies cannot be printed.
- Before printing, be sure to set the paper size.
- Certain printers may not be able to imprint the file number.
- If **[Bordered]** is set, certain printers may imprint the date on the border.
- Depending on the printer, the date may appear faint if it is imprinted on a bright background or on the border.
- RAW images cannot be printed by selecting **[Print order]**. When printing, select **[Print image]** and print.



- When you use a battery to power the camera, make sure it is fully charged.
- Depending on the image's file size and image quality, it may take some time to start printing after you select **[Print]**.
- To stop printing, press **<SET>** while **[Stop]** is displayed, then select **[OK]**.
- When printing with **[Print order]**, if you stopped printing and want to resume printing of the remaining images, select **[Resume]**. Note that printing will not resume if any of the following occurs.
 - You change the print order or delete any of the print ordered images before resuming printing.
 - When index is set, you change the paper setting before resuming printing.
- If a problem occurs during printing, see 443.

Print Settings

The screen display and setting options vary depending on the printer. Also, certain settings may not be available. For details, refer to the printer's instruction manual.

Print setting screen

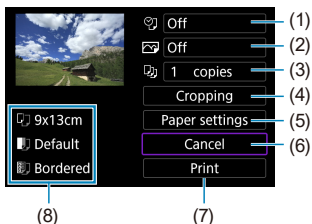

- (1) Sets date or file number printing (📖 441).
- (2) Sets the printing effects (📖 441).
- (3) Sets the number of copies to print (📖 441).
- (4) Sets the print area (📖 442).
- (5) Sets the paper size, type, and layout (📖 440).
- (6) Returns to the image selection screen.
- (7) Starts the printing.
- (8) The paper size, type, and layout you have set are displayed.

* Depending on the printer, certain settings may not be selectable.

Paper Settings

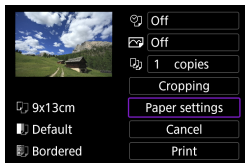

- Select **[Paper settings]**.

Setting the Paper Size

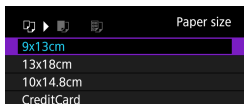

- Select the size of the paper in the printer.

Setting the Paper Type

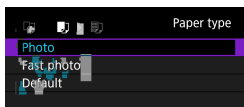

- Select the type of the paper in the printer.

Setting the Page Layout

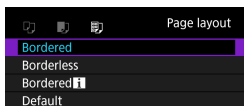

- Select the page layout.

-  ● If the image's aspect ratio is different from the printing paper's aspect ratio, the image may be cropped significantly when you print it as a borderless print. Images may also be printed at lower resolution.

[📄] Setting the Date/File Number Imprinting

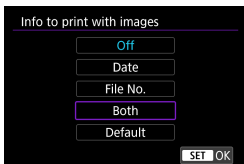

- Select [📄].
- Select what to print.

[🖨️] Setting the Printing Effects (Image Optimization)

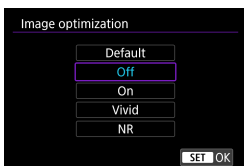

- Select [🖨️].
- Select printing effects.



- If you imprint shooting information on an image shot at an expanded ISO speed (**H**), the correct ISO speed may not be imprinted.
- The **[Default]** setting for printing effects and other options are the printer's own default settings as set by the printer's manufacturer. Refer to the printer's instruction manual to find out what the **[Default]** settings are.

[📄] Setting the Number of Copies



- Select [📄].
- Select the number of copies to print.

Cropping the Image

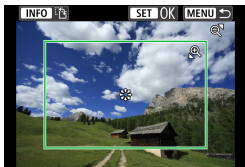

Set cropping immediately before printing. Changing other print settings after you crop images may require you to crop the images again.

1 On the print setting screen, select [Cropping].

2 Set the cropping frame size, position, and aspect ratio.

- The image area within the cropping frame will be printed. The shape of the frame (aspect ratio) can be changed with [Paper settings].

Changing the Cropping Frame Size

Turn the <Q> <[]> dial to change the cropping frame size.

Moving the Cropping Frame

Use <[]> <[]> to move the frame vertically or horizontally.

Switching the Orientation of the Cropping Frame

Pressing the <INFO> button will toggle the cropping frame between the vertical and horizontal orientations.

3 Press <[SET]> to exit the cropping.

- You can check the cropped image area on the upper left of the print setting screen.



- Depending on the printer, the cropped image area may not be printed as you specified.
- The smaller the cropping frame, the lower the resolution at which images are printed.



Handling Printer Errors

- If printing does not resume after you resolve a printer error (no ink, no paper, etc.) and select **[Continue]**, operate the buttons on the printer. For details on resuming printing, refer to the printer's instruction manual.

Error Messages

- If a problem occurs during printing, an error message will appear on the camera screen. After fixing the problem, resume printing. For details on how to fix a printing problem, refer to the printer's instruction manual.

Paper Error

- Confirm that paper is loaded correctly.

Ink Error

- Check the printer's ink level and the waste ink tank.

Hardware Error

- Check for any printer problems other than paper and ink problems.

File Error

- The selected image cannot be printed. Images taken with a different camera or images edited with a computer may not be printable.

Sending Images to a Web Service

This section describes how to use Web services to send images.

Registering Web Services

Use a smartphone or computer to add your Web services to the camera.

- A smartphone or computer with a browser and Internet connection is required to complete camera settings for CANON iMAGE GATEWAY and other Web services.
- Visit the CANON iMAGE GATEWAY website for details on versions of browsers (such as Microsoft Internet Explorer) and settings required for CANON iMAGE GATEWAY access.
- For information on countries and regions where CANON iMAGE GATEWAY is available, visit the Canon website (<http://www.canon.com/cig/>).
- For CANON iMAGE GATEWAY instructions and setting details, refer to the help information for CANON iMAGE GATEWAY.
- If you also intend to use Web services other than CANON iMAGE GATEWAY, you must have an account with the services you intend to use. For further details, check the websites for each Web service you will register.
- Fees to connect to your provider and communication fees to access your provider's access point are charged separately.

Registering CANON IMAGE GATEWAY

Link the camera and CANON iIMAGE GATEWAY by adding CANON IMAGE GATEWAY as a destination Web service on the camera.

You will need to enter an email address used on your computer or smartphone.

Steps on the Camera (1)

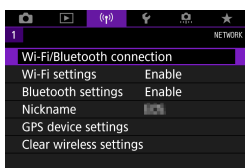

- 1 Select [(Wi-Fi/Bluetooth connection)].

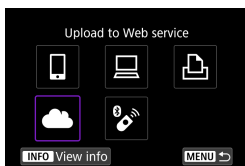

- 2 Select [Upload to Web service].

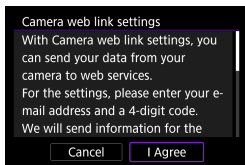

- 3 Select [I Agree].

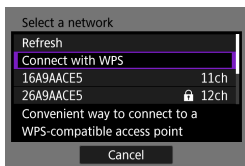

- 4 Establish a Wi-Fi connection.
 - Connect to an access point via Wi-Fi. Go to step 6 on 460.

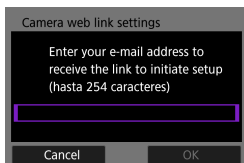

5 Enter your email address.

- Enter your email address, then select [OK].

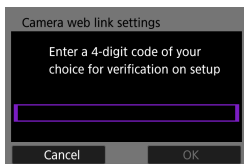

6 Enter a four-digit number.

- Enter a four-digit number of your choice, then select [OK].

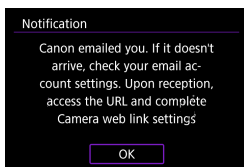

7 Select [OK].

- The [☁] icon changes to [☁G].

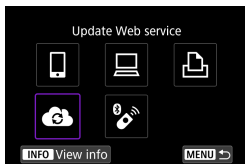

Steps on the Computer or Smartphone

8 Set up camera web link.

- Access the page in the notification message.
- Follow the instructions to complete the settings on the camera web link settings page.

Steps on the Camera (2)

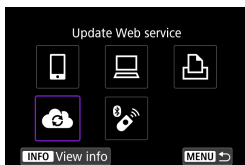

9 Add CANON IMAGE GATEWAY as a destination.

- Select [G].
CANON IMAGE GATEWAY is now added.



Registering Other Web Services

Steps on the Computer or Smartphone

1 Configure the Web service you want to use.

- Visit the CANON iMAGE GATEWAY website and access the camera web link settings page.
- Follow the on-screen instructions to complete settings for Web services you want to use.

Steps on the Camera

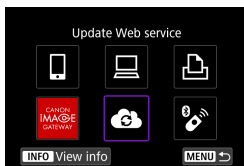

2 Add the Web service you configured as a destination.

- Select [(P): Wi-Fi/Bluetooth connection].
- Select [C].

Sending Images

You can share images with your family and friends by sending images from the camera to a Web service registered on the camera or by sending Web links of the online albums.

Connecting to Web Services via Wi-Fi

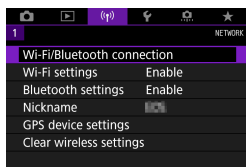

- 1 Select [(1)]: Wi-Fi/Bluetooth connection].

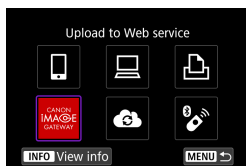

- 2 Select a Web service.
 - If the history (📖 467) is displayed, switch the screen with the <<> <>> keys.
 - A screen to select a destination may be displayed, depending on the type and settings of the Web service (📖 462).

Sending Images Individually

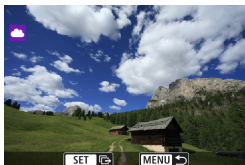

1 Select an image to send.

- Press the <◀> <▶> keys or turn the <⦿> dial to select an image to send, then press <SET>.
- You can press the <📷-Q> button to select the image using the index display.



2 Select [Send img shown].

- In [Size to send], you can select the image sending size.
- On the screen after images are sent, select [OK] to end the Wi-Fi connection.

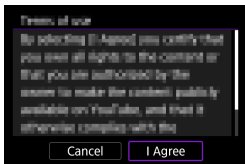

- When the [Terms of use] screen is displayed, thoroughly read the message, then select [I Agree].
- To scroll the screen, use the <▲> <▼> keys.

Sending Multiple Selected Images

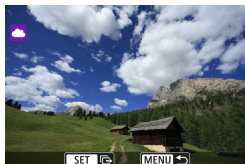

1 Press <SET>.



2 Select [Send selected].

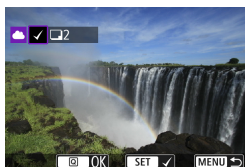

3 Select images to send.

- Press the <◀> <▶> keys or turn the <⦿> dial to select images to send, then press <SET>.
- You can press the <☒·Q> button to select the image from 3-image display. To return to the single-image display, press the <Q> button.
- After selecting the images to send, press the <Q> button.

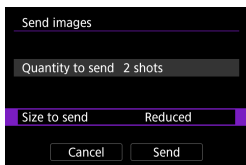

4 Select [Size to send].

- When YouTube is selected as the destination, **[Size to send]** is not displayed.
- On the displayed screen, select an image size.

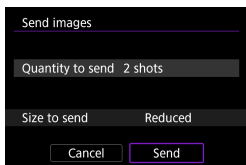
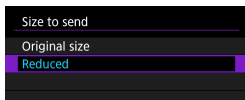

5 Select [Send].

- On the screen after images are sent, select **[OK]** to end the Wi-Fi connection.

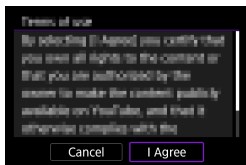

- When the **[Terms of use]** screen is displayed, thoroughly read the message, then select **[I Agree]**.
- To scroll the screen, use the <▲> <▼> keys.

Sending a Specified Range of Images

Specify the range of images to send all the images in the range at once.

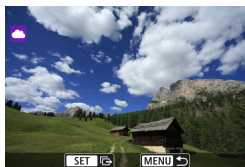

1 Press **<SET>**.



2 Select **[Send range]**.

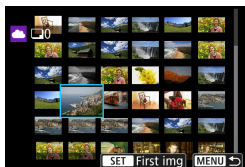

3 Specify the range of images.

- Select the first image (start point).
- Select the last image (end point).
Images will be selected and **[√]** will appear.
- To cancel the selection, repeat this step.
- You can press the **<[Q]>** button to change the number of images shown in the index display.

4 Confirm the range.

- Press the **<[Q]>** button.

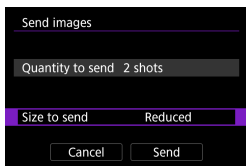

- 5 Select [Size to send].**
- On the displayed screen, select an image size.

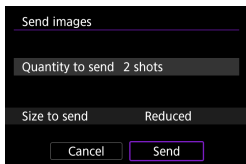
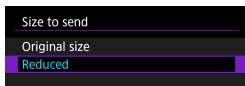

- 6 Select [Send].**
- On the screen after images are sent, select **[OK]** to end the Wi-Fi connection.

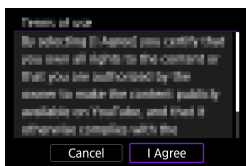

- When the **[Terms of use]** screen is displayed, thoroughly read the message, then select **[I Agree]**.
- To scroll the screen, use the **<▲>** **<▼>** keys.

Sending All Images on the Card



- 1 Press <SET>.**

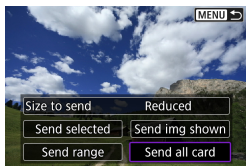

- 2 Select [Send all card].**

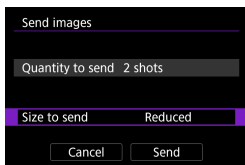

3 Select [Size to send].

- On the displayed screen, select an image size.

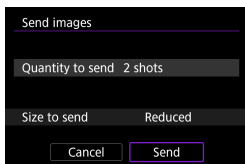
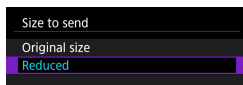

4 Select [Send].

- On the screen after images are sent, select **[OK]** to end the Wi-Fi connection.

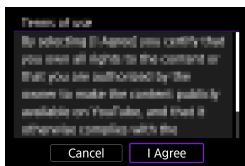

- When the **[Terms of use]** screen is displayed, thoroughly read the message, then select **[I Agree]**.
- To scroll the screen, use the **<▲>** **<▼>** keys.

Sending Images that Match the Search Conditions

Send all the images that match the search conditions set in **[Set image search conditions]** at once.

For **[Set image search conditions]**, refer to “Filtering Images for Playback” (p.385).



1 Press < **SET** >.



2 Select **[Send all found]**.

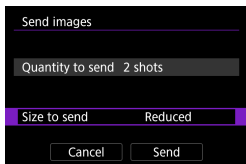

3 Select **[Size to send]**.

- On the displayed screen, select an image size.

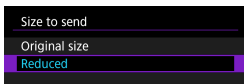

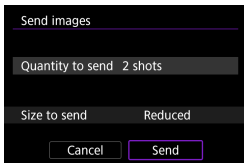

4 Select [Send].

- On the screen after images are sent, select **[OK]** to end the Wi-Fi connection.

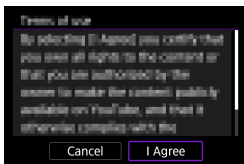

- When the **[Terms of use]** screen is displayed, thoroughly read the message, then select **[I Agree]**.
- To scroll the screen, use the **<▲>** **<▼>** keys.



- With a Wi-Fi connection to a Web service established, a picture cannot be taken even if the camera's shutter button is pressed.
- When sending an image to a Web service other than CANON iMAGE GATEWAY, a send error message may not be displayed even if the image has not been sent to the Web service successfully. Since such send errors can be checked on the CANON iMAGE GATEWAY site, check the error content, then try sending the image again.



- Depending on the Web service, the type or number of images that can be sent and the length of movies will be limited.
- Certain images may not be able to be sent with **[Send range]**, **[Send all card]**, or **[Send all found]**.
- When you reduce the image size, all images to be sent at the same time are resized. Note that movies or **S2** size still photos are not reduced.
- **[Reduced]** is enabled only for still photos shot with cameras of the same model as this camera. Still photos shot with other models are sent without resizing.
- When accessing CANON iMAGE GATEWAY, you can check the send history for the Web services that the images were sent to.
- When you use a battery to power the camera, make sure it is fully charged.

Wi-Fi Connection via Access Points

This section describes how to join a Wi-Fi network via an access point compatible with WPS (PCB mode).

First, check the position of the WPS button and how long to press it. It may take approx. one minute to establish a Wi-Fi connection.

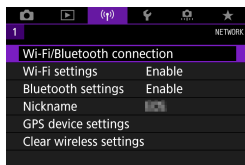

1 Select [**(?)**: **Wi-Fi/Bluetooth connection**].

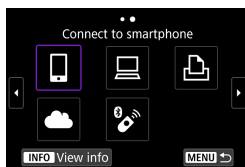

2 Select an item.

- If the history (📖 467) is displayed, switch the screen with the <<> >>> keys.

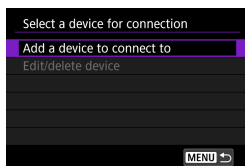

3 Select [**Add a device to connect to**].

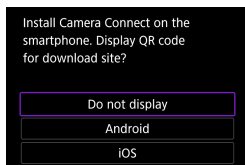

- When [**☐ Connect to smartphone**] is selected, the screen on the left is displayed. If Camera Connect is already installed, select [**Do not display**].
- On the [**Connect to smartphone**] screen displayed next, select [**Connect via Wi-Fi**].

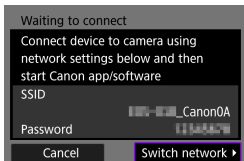

4 Select [Switch network].

- Displayed when [📱], [💻], or [🖨️] is selected.

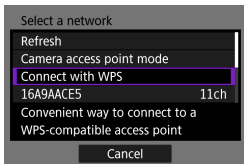

5 Select [Connect with WPS].



- For [Camera access point mode] displayed in step 5, see 📖 462.

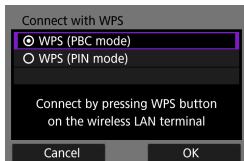

- 6 Select [WPS (PBC mode)].**
- Select [OK].

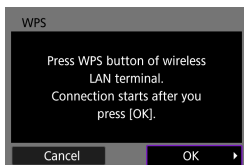

- 7 Connect to the access point via Wi-Fi.**

- Press the access point's WPS button.
- Select [OK].

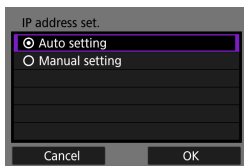

- 8 Select [Auto setting].**

- Select [OK] to access the setting screen for the Wi-Fi function.
- If an error occurs with [Auto setting], see 462.

9 Specify the settings for the Wi-Fi function.

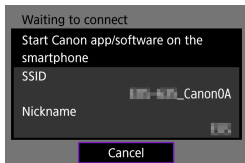

[📱 Connect to smartphone]

- On the smartphone's Wi-Fi setting screen, tap the SSID (network name) shown on the camera, then enter the password of the access point for the connection.

Go to step 8 on [410](#).

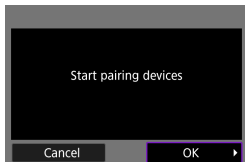

[🖨️ Remote control (EOS Utility)]

Go to step 7 or 8 on [428](#).

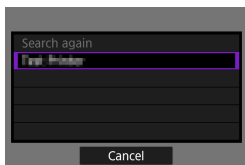

[🖨️ Print from Wi-Fi printer]

Go to step 6 on [435](#).

Registering CANON iIMAGE GATEWAY

Go to step 5 on [446](#).

Send To Screen

A screen to select a destination may be displayed depending on the Web service.

To register destinations or to specify the settings, you must use a computer. For more information, refer to the EOS Utility Instruction Manual.

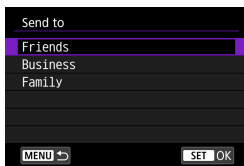

- The **[Send to]** screen may be displayed.
- Select the destination from the list of registered destinations.
- The procedures for setting up a connection and sending images are the same as those for other Web services.

Camera Access Point Mode

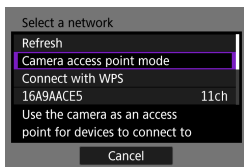

Camera access point mode is a connection mode for connecting the camera directly to each device via Wi-Fi.

Displayed when **[]**, **[]**, or **[]** is selected in **[Wi-Fi function]**.

Manual IP Address Setup

The items displayed vary depending on the Wi-Fi function.

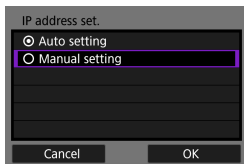

- 1 **Select [Manual setting].**
 - Select **[OK]**.

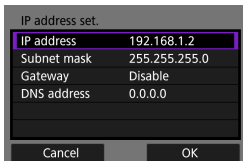



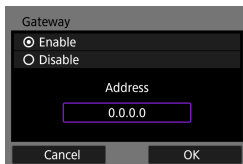

2 Select an item.

- Select an item to access the screen for numerical input.
- To use a gateway, select **[Enable]**, then select **[Address]**.



3 Enter the desired values.

- Turn the  dial to move the input position in the upper area and use the   keys to select the number. Press  to enter the selected number.
- To set the entered values and return to the screen for step 2, press the **<MENU>** button.

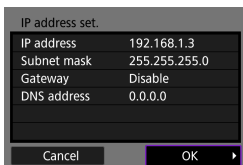

4 Select [OK].

- When you have completed setting the necessary items, select **[OK]**.
- If you are not sure what to enter, see “Checking Network Settings” (📖 497), or ask the network administrator or another person knowledgeable about the network.

Connecting to a Wireless Remote Control

This camera can also be connected to Wireless Remote Control BR-E1 (sold separately) via Bluetooth for remote control shooting (📖 156).

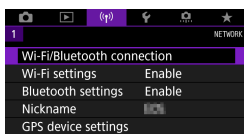

1 Select [(?)]: Wi-Fi/Bluetooth connection].

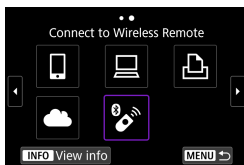

2 Select [📶 Connect to Wireless Remote].

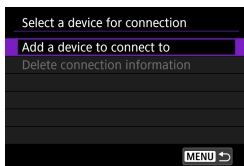

3 Select [Add a device to connect to].





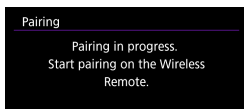

4 Press <SET>.



5 Pair the devices.

- When the [Pairing] screen appears, press and hold the <W> and <T> buttons on the BR-E1 simultaneously for at least 3 sec.
- After a message confirms that the camera is paired with the BR-E1, press <SET>.

6 Set up the camera for remote shooting.

- When shooting still photos, select [] or [] as the drive mode ( 153).
- When recording movies, set [: **Remote control**] to [**Enable**].
- For instructions after the pairing is complete, refer to the BR-E1's Instruction Manual.



- Bluetooth connections consume battery power even after the camera's auto power off is activated.



- When you do not use the Bluetooth function, setting it to [**Disable**] in step 1 is recommended.

Canceling the Pairing

Before pairing with a different BR-E1, clear the information about the connected remote control.

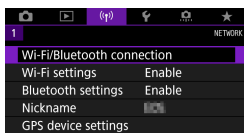

1 Select [(Wi-Fi/Bluetooth connection)].

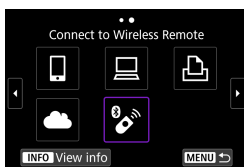

2 Select [(Connect to Wireless Remote)].

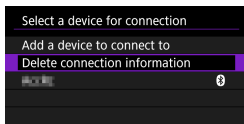

3 Select [Delete connection information].

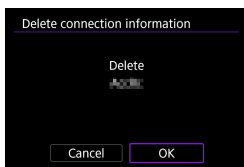

4 Select [OK].

Reconnecting via Wi-Fi

Follow these steps to reconnect to devices or Web services with registered connection settings.

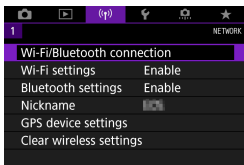

1 Select [(Wi-Fi)]: Wi-Fi/Bluetooth connection.



2 Select an item.

- Select the item to connect to via Wi-Fi from the displayed history. If the item is not displayed, use the <◀> <▶> keys to switch screens.
- If [Connection history] is set to [Hide], the history will not be displayed (470).

3 Operate the connected device.

[Smartphone]

- Start Camera Connect.
- If the smartphone's connection destination has been changed, restore the setting to connect via Wi-Fi to the camera or the same access point as the camera.

When directly connecting the camera to a smartphone via Wi-Fi, “_Canon0A” is displayed at the end of the SSID.

[] Computer

- On the computer, start the EOS software.
- If the computer's connection destination has been changed, restore the setting to connect via Wi-Fi to the camera or the same access point as the camera.

When directly connecting the camera to a computer via Wi-Fi, “_Canon0A” is displayed at the end of the SSID.

[] Printer

- If the printer's connection destination has been changed, restore the setting to connect via Wi-Fi to the camera or the same access point as the camera.

When directly connecting the camera to a printer via Wi-Fi, “_Canon0A” is displayed at the end of the SSID.

Registering Multiple Connection Settings

You can register up to 10 connection settings for the wireless communication functions.

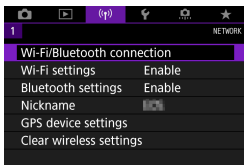

1 Select []: Wi-Fi/Bluetooth connection].

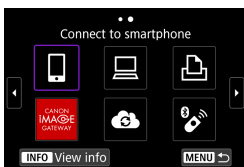

2 Select an item.

- If the history (467) is displayed, switch the screen with the << >> <> >> keys.
- For details on [**Connect to smartphone**], see “Connecting to a Smartphone” (399).
- For details on [**Remote control (EOS Utility)**], see “Connecting to a Computer via Wi-Fi” (426).
- For details on [**Print from Wi-Fi printer**], see “Connecting to a Printer via Wi-Fi” (434).
- When sending images to a Web service, see “Sending Images to a Web Service” (444).



- To delete connection settings, see 478.

Wi-Fi Settings

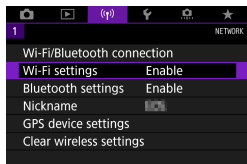

1 Select [(P)]: Wi-Fi settings].

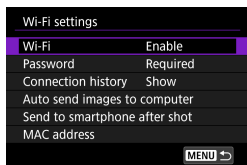

2 Select an item.

● Wi-Fi

When the use of electronic devices and wireless devices is prohibited, such as on board airplanes or in hospitals, set it to **[Disable]**.

● Password

Set to **[None]** to allow a Wi-Fi connection to be established without a password (except when connecting to an access point via Wi-Fi).

● Connection history

You can set whether to **[Show]** or **[Hide]** the history of the Wi-Fi connected devices.

● Auto send images to computer

With the dedicated software Image Transfer Utility 2, you can send images on the camera to a computer automatically (📖 431).

● Send to smartphone after shot

Your shots can be sent to a smartphone automatically (📖 412).

● MAC address

You can check the MAC address of the camera.

Bluetooth Settings

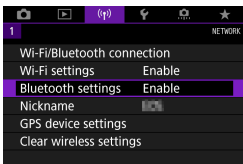

1 Select [(p)]: Bluetooth settings].

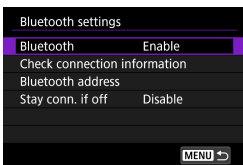

2 Select an item.

- **Bluetooth**

If you will not use the Bluetooth function, select **[Disable]**.

- **Check connection information**

You can check the name and communication status of the paired device.

- **Bluetooth address**

You can check the camera's Bluetooth address.

- **Stay conn. if off**

Displayed after the camera is paired with a smartphone via Bluetooth. Selecting **[Enable]** lets you view images on the camera and control it in other ways by connecting via Wi-Fi even if the camera is off (📖 405).

Changing the Nickname

You can change the camera nickname (displayed on smartphones and other cameras) as needed.

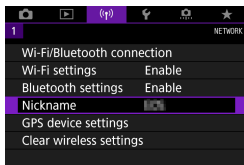

1 Select [(?)]: Nickname].

2 Enter text using the virtual keyboard (📖 482).

- When you finish entering characters, press the <MENU> button.

Geotagging Images with GPS Information from Other Devices

You can geotag images with GPS Receiver GP-E2 (sold separately) or a Bluetooth enabled smartphone.

GP-E2

1 Attach GP-E2 to the camera.

- Attach GP-E2 to the camera's hot shoe and turn it on. For details, refer to the GP-E2 Instruction Manual.

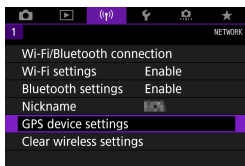

2 Select [(📍)]: GPS device settings].

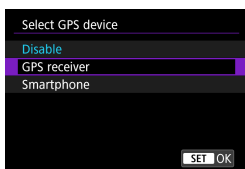

3 In [Select GPS device], select [GPS receiver].

4 Take the picture.

- For details on [Set up], refer to the GP-E2 Instruction Manual.



Precautions When Using GP-E2

- Be sure to check the countries and regions where its use is allowed, and use the function in accordance with the laws and regulations of the country or region.
- Make sure the GP-E2 firmware is updated to Ver. 2.0.0 or later. Firmware updating requires an interface cable. For updating instructions, visit the Canon website.
- The cable cannot be used to connect the camera to the GP-E2.
- The camera does not record the shooting direction.

Smartphone

Complete these settings after installing the dedicated Camera Connect app (📖 399) on the smartphone.

- 1 On the smartphone, activate location services.
- 2 Establish a Bluetooth connection.
 - Connect the camera to a smartphone via Bluetooth (📖 400).
- 3 Select [(📍)]: GPS device settings].

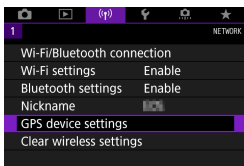

- 4 Select [Smartphone] in [Select GPS device].
 - After these settings are complete, start Camera Connect.

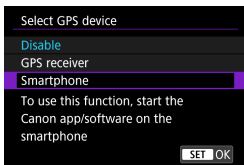

- 5 Take the picture.
 - Images are geotagged with the information from the smartphone.

GPS Connection Display

You can check the status of smartphone location information acquisition in the GPS connection icon on the screens for still photo or movie shooting (📖 623 and 📖 625, respectively).

- Gray: Location services are off
- Blinking: Location information cannot be acquired
- On: Location information acquired

For details on how GPS connection status is indicated when the GP-E2 is used, refer to the GP-E2 Instruction Manual.

Geotagging images as you shoot

Images you shoot while the GPS icon is on are geotagged.

Geotagging information

You can check the location information added to your shots on the shooting information screen (📖 332, 📖 389).

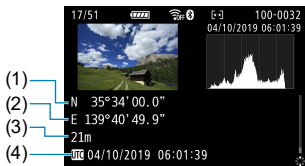

- (1) Latitude
- (2) Longitude
- (3) Elevation
- (4) UTC (Coordinated Universal Time)



- The smartphone can acquire location information only while it is paired with the camera via Bluetooth.
- Direction information is not acquired.
- Acquired location information may not be accurate, depending on traveling conditions or smartphone status.
- It may take some time to acquire location information from the smartphone after you turn the camera on.
- Location information is no longer acquired after any of the following operations.
 - Pairing with a wireless remote control via Bluetooth
 - Turning the camera off
 - Quitting Camera Connect
 - Deactivating location services on the smartphone
- Location information is no longer acquired in any of the following situations.
 - The camera power turns off
 - The Bluetooth connection is ended
 - The smartphone's remaining battery level is low



- Coordinated Universal Time, abbreviated as UTC, is essentially the same as Greenwich Mean Time.
- For movies, the GPS information initially acquired is added.

Changing or Deleting Connection Settings

To change or delete the connection settings, terminate the Wi-Fi connection first.

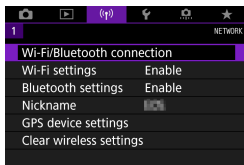

1 Select [(?)]: Wi-Fi/Bluetooth connection].

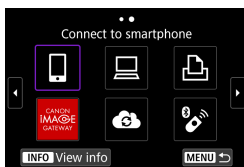

2 Select an item.

- If the history (📖 467) is displayed, switch the screen with the <◀> <▶> keys.

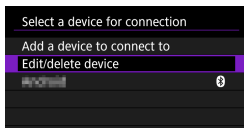

3 Select [Edit/delete device].

- You can change the Bluetooth connection by selecting a smartphone labeled with [📱] in gray. After the [Connect to smartphone] screen is displayed, select [Pair via Bluetooth], then press <SET> on the next screen.

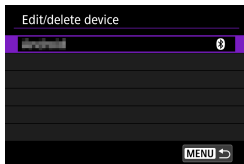

4 Select the device for which to change or delete the connection settings.

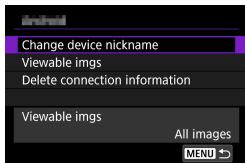

5 Select an item.

- Change or delete the connection settings on the displayed screen.

● Change device nickname

You can change the nickname using the virtual keyboard (📖 482).

● Viewable imgs (📖 422)

Displayed when [**Connect to smartphone**] is selected. Settings will appear at the bottom of the screen.

● Delete connection information

When deleting connection information for a paired smartphone, also delete the camera information registered on the smartphone (📖 406).



- For Web services, visit the CANON IMAGE GATEWAY website to delete the connection settings.

Clearing Wireless Communication Settings to Default

All wireless communication settings can be deleted. By deleting the wireless communication settings, you can prevent their information from being exposed when you lend or give your camera to other people.

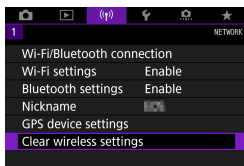

1 Select [(1): Clear wireless settings].



2 Select [OK].

- Performing [(2): Clear all camera settings] does not delete the wireless communication setting information.
- If you have paired the camera with a smartphone, on the smartphone's Bluetooth settings screen, delete the connection information of the camera for which you restored default wireless communication settings.

View Info Screen

You can check error details and the camera's MAC address.

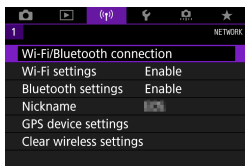

- 1 Select [**(Wi-Fi/Bluetooth connection)**].

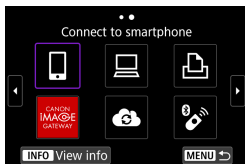

- 2 Press the **<INFO>** button.
 - The **[View info]** screen will appear.

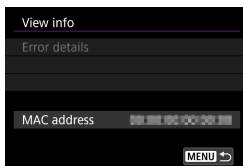

- When an error has occurred, press **<SET>** to display the error content.

Virtual Keyboard Operations

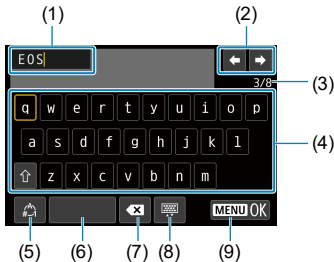

(1) Input area, for entering text

(2) Cursor keys, for moving in the input area

(3) Current no. of characters/no. available

(4) Keyboard

(5) Switch input modes

(6) Space

(7) Delete a character in the input area

(8) Change the type of keyboard

(9) Finish the text entry

- Use <⬅️> <➡️> to move within 2 and 4–8.
- Press <Ⓜ️> to confirm input or when switching input modes.

Responding to Error Messages

When an error occurs, display the details of the error by following one of the procedures below. Then, eliminate the cause of the error by referring to the examples shown in this chapter.

- On the **[View info]** screen, press <SET> (📖 481).
- Select **[Error details]** on the **[Wi-Fi on]** screen.

Click the error code number's page in the following chart to jump to the corresponding page.

11 (📖 484)	12 (📖 484)	21 (📖 485)	22 (📖 486)
23 (📖 487)	61 (📖 488)	63 (📖 489)	64 (📖 489)
65 (📖 490)	66 (📖 490)	67 (📖 490)	68 (📖 491)
69 (📖 491)	91 (📖 491)	121 (📖 491)	125 (📖 492)
126 (📖 492)	127 (📖 492)	141 (📖 492)	142 (📖 492)
151 (📖 493)	152 (📖 493)		



- When an error occurs, **[Err**]** is displayed on the upper right of the **[Wi-Fi/Bluetooth connection]** screen. It disappears when the camera's power is set to <OFF>.

11: Connection target not found

- In the case of [❏], is Camera Connect running?
 - ▶ Establish a connection using Camera Connect (📖 410).
- In the case of [📷], is the EOS software running?
 - ▶ Start the EOS software and reestablish the connection (📖 428).
- In the case of [🖨️], is the power of the printer on?
 - ▶ Turn on the printer.
- Are the camera and the access point set to use the same password for authentication?
 - ▶ This error occurs if the passwords do not match when the authentication method for encryption is set to **[Open system]**. The setting is case-sensitive, so check upper- and lower-case characters. Make sure that the correct password for authentication is set on the camera (📖 482).

12: Connection target not found

- Is the power of the target device and access point on?
 - ▶ Turn on the target device and access point, then wait a while. If a connection still cannot be established, perform the procedures to establish the connection again.

21: No address assigned by DHCP server

What to check on the camera

- On the camera, IP address is set to **[Auto setting]**. Is this the correct setting?
 - ▶ If no DHCP server is used, specify the settings after setting the IP address to **[Manual setting]** on the camera (📖462).

What to check on the DHCP server

- Is the power of the DHCP server on?
 - ▶ Turn on the DHCP server.
- Are there enough addresses for assignment by the DHCP server?
 - ▶ Increase the number of addresses assigned by the DHCP server.
 - ▶ Remove devices assigned addresses by the DHCP server from the network to reduce the number of addresses in use.
- Is the DHCP server working correctly?
 - ▶ Check the DHCP server settings to make sure it is working correctly as a DHCP server.
 - ▶ If applicable, ask your network administrator to ensure the DHCP server is available.

22: No response from DNS server

What to check on the camera

- On the camera, does the DNS server's IP address setting match the server's actual address?
 - ▶ Set the IP address to **[Manual setting]**. Then, on the camera, set the IP address that matches the address of the DNS server used (📖 497, 📖 462).

What to check on the DNS server

- Is the power of the DNS server on?
 - ▶ Turn on the DNS server.
- Are the DNS server settings for IP addresses and the corresponding names correct?
 - ▶ On the DNS server, make sure IP addresses and the corresponding names are entered correctly.
- Is the DNS server working correctly?
 - ▶ Check the DNS server settings to make sure it is working correctly as a DNS server.
 - ▶ If applicable, ask your network administrator to ensure the DNS server is available.

What to check on the network as a whole

- Does the network that you are trying to connect to via Wi-Fi include a router or similar device that serves as a gateway?
 - ▶ If applicable, ask your network administrator for the network gateway address and enter it on the camera (📖 497, 📖 462).
 - ▶ Make sure that the gateway address setting is correctly entered on all network devices including the camera.

23: Device with same IP address exists on selected network

What to check on the camera

- Do the camera and another device connected via Wi-Fi to the same network have the same IP address?
 - ▶ Change the camera's IP address to avoid using the same address as another device on the network. Otherwise, change the IP address of the device that has a duplicate address.
 - ▶ If the camera's IP address is set to **[Manual setting]** in network environments using a DHCP server, change the setting to **[Auto setting]** (📖 460).



Responding to Error Messages 21–23

- Also check the following points when responding to errors numbered 21–23.
- **Are the camera and the access point set to use the same password for authentication?**
 - This error occurs if the passwords do not match when the authentication method for encryption is set to **[Open system]**. The setting is case-sensitive, so check upper- and lower-case characters. Make sure that the correct password for authentication is set on the camera (📖 482).

61: Selected SSID wireless LAN network not found

- Are any obstacles blocking the line of sight between the camera and the antenna of the access point?
 - ▶ Move the antenna of the access point to a position clearly visible from the point of view of the camera (📖 494).

What to check on the camera

- Does the SSID set on the camera match that of the access point?
 - ▶ Check the SSID at the access point, then set the same SSID on the camera.

What to check at the access point

- Is the access point turned on?
 - ▶ Turn on the power of the access point.
- If filtering by MAC address is active, is the MAC address of the camera in use registered at the access point?
 - ▶ Register the MAC address of the camera used to the access point. The MAC address can be checked on the **[View info]** screen (📖 481).

63: Wireless LAN authentication failed

- Are the camera and the access point set to use the same authentication method?
 - ▶ The camera supports the following authentication methods: **[Open system]**, **[Shared key]**, and **[WPA/WPA2-PSK]**.
- Are the camera and the access point set to use the same password for authentication?
 - ▶ The setting is case-sensitive, so check upper- and lower-case characters. Make sure that the correct password for authentication is set on the camera.
- If filtering by MAC address is active, is the MAC address of the camera in use registered at the access point?
 - ▶ Register the MAC address of the camera used to the access point. The MAC address can be checked on the **[View info]** screen (📖 481).

64: Cannot connect to wireless LAN terminal

- Are the camera and the access point set to use the same encryption method?
 - ▶ The camera supports the following encryption methods: WEP, TKIP, and AES.
- If filtering by MAC address is active, is the MAC address of the camera in use registered at the access point?
 - ▶ Register the MAC address of the camera used to the access point. The MAC address can be checked on the **[View info]** screen (📖 481).

65: Wireless LAN connection lost

- Are any obstacles blocking the line of sight between the camera and the antenna of the access point?
 - ▶ Move the antenna of the access point to a position clearly visible from the point of view of the camera (📖 494).
- The Wi-Fi connection was lost for some reason, and the connection cannot be restored.
 - ▶ The following are possible reasons: excessive access to the access point from another device, a microwave oven or similar appliance in use nearby (interfering with IEEE 802.11b/g/n (2.4 GHz band)), or influence of rain or high humidity (📖 494).

66: Incorrect wireless LAN password

- Are the camera and the access point set to use the same password for authentication?
 - ▶ The setting is case-sensitive, so check upper- and lower-case characters. Make sure that the correct password for authentication is set on the camera.

67: Incorrect wireless LAN encryption method

- Are the camera and the access point set to use the same encryption method?
 - ▶ The camera supports the following encryption methods: WEP, TKIP, and AES.
- If filtering by MAC address is active, is the MAC address of the camera in use registered at the access point?
 - ▶ Register the MAC address of the camera used to the access point. The MAC address can be checked on the **[View info]** screen (📖 481).

68: Cannot connect to wireless LAN terminal. Retry from the beginning.

- Did you hold down the access point's WPS (Wi-Fi Protected Setup) button for the specified period of time?
 - ▶ Hold down the WPS button for the period of time specified in the access point's instruction manual.
- Are you trying to establish a connection near the access point?
 - ▶ Try establishing the connection when both devices are within reach of each other.

69: Multiple wireless LAN terminals have been found. Cannot connect. Retry from the beginning.

- Connection is in progress by other access points in Pushbutton Connection mode (PBC mode) of WPS (Wi-Fi Protected Setup).
 - ▶ Wait a while before trying to establish the connection.

91: Other error

- A problem other than error code number 11 to 69 occurred.
 - ▶ Turn the camera's power switch off and on.

121: Not enough free space on server

- The target Web server does not have enough free space.
 - ▶ Delete unnecessary images on the Web server, check the free space on the Web server, then try sending the data again.

125: Check the network settings

- Is the network connected?
 - ▶ Check the connection status of the network.

126: Could not connect to server

- CANON IMAGE GATEWAY is under maintenance or load is concentrated temporarily.
 - ▶ Try connecting to the Web service again later.

127: An error has occurred

- A problem other than error code number 121 to 126 occurred while the camera is connected to the Web service.
 - ▶ Try again to establish the Wi-Fi connection to the Web service.

141: Printer is busy. Try connecting again.

- Is the printer performing a printing process?
 - ▶ Try again to establish the Wi-Fi connection to the printer after the printing process is finished.
- Is another camera connected to the printer via Wi-Fi?
 - ▶ Try again to establish the Wi-Fi connection to the printer after the Wi-Fi connection to the other camera has been terminated.

142: Could not acquire printer information. Reconnect to try again.

- Is the power of the printer on?
 - ▶ Try again to establish the Wi-Fi connection after turning on the printer.

151: Transmission canceled

- Automatic image transfer to the computer was somehow interrupted.
 - ▶ To resume automatic image transfer, set the camera's power switch to <OFF>, and then set it to <ON>.

152: Card's write protect switch is set to lock

- Is the card's write protect switch set to the locked position?
 - ▶ Slide the card's write protect switch to the writing position.

Wireless Communication Function Notes

If the transmission rate drops, the connection is lost, or other problems occur when using the wireless communication functions, try the following corrective actions.

Distance Between the Camera and the Smartphone

If the camera is too far from the smartphone, a Wi-Fi connection may not be established even when Bluetooth connection is possible. In this case, bring the camera and the smartphone closer together, then establish a Wi-Fi connection.

Installation Location of Access Point Antenna

- When using indoors, install the device in the room where you are using the camera.
- Install the device where people or objects do not come between the device and the camera.

Nearby Electronic Devices

If the Wi-Fi transmission rate drops because of the influence of the following electronic devices, stop using them or move further away from the devices to transmit communication.

- The camera communicates over Wi-Fi via IEEE 802.11b/g/n using radio waves in the 2.4 GHz band. For this reason, the Wi-Fi transmission rate will drop if there are Bluetooth devices, microwave ovens, cordless telephones, microphones, smartphones, other cameras, or similar devices operating on the same frequency band nearby.

Cautions for Using Multiple Cameras

- When connecting multiple cameras to one access point via Wi-Fi, make sure the cameras' IP addresses are different.
- When multiple cameras are connected to one access point via Wi-Fi, the transmission rate drops.
- When there are multiple IEEE 802.11b/g/n (2.4 GHz band) access points, leave a gap of five channels between each Wi-Fi channel to reduce radio wave interference. For example, use channels 1, 6, and 11, channels 2 and 7, or channels 3 and 8.

Using the Wireless Remote Control BR-E1

- BR-E1 cannot be used while the camera and smartphone are paired via Bluetooth. Change the camera connection to the wireless remote control in **[Connect to Wireless Remote]** under **[⌘]: Wi-Fi/Bluetooth connection]**.

Security

If security settings have not been properly set, the following problems may occur.

- **Transmission monitoring**

Third parties with malicious intent may monitor the Wi-Fi transmissions and attempt to acquire the data you are sending.

- **Unauthorized network access**

Third parties with malicious intent may gain unauthorized access to the network you are using to steal, modify, or destroy information.

Additionally, you could fall victim to other types of unauthorized access such as impersonation (where someone assumes an identity to gain access to unauthorized information) or springboard attacks (where someone gains unauthorized access to your network as a springboard to cover their tracks when infiltrating other systems).

It is recommended to make use of the systems and functions to thoroughly secure your network, preventing these types of problems from occurring.

Checking Network Settings

● Windows

Open the Windows **[Command Prompt]**, then type `ipconfig/all` and press the **<Enter>** key.

In addition to the IP address assigned to the computer, the subnet mask, gateway, and DNS server information are also displayed.

● Mac OS

In Mac OS X, open the **[Terminal]** application, enter `ifconfig -a`, and press the **<Return>** key. The IP address assigned to the computer is indicated in the **[en0]** item next to **[inet]**, in the format `****.***.***.***`.

* For information about the **[Terminal]** application, refer to the Mac OS X help.

To avoid using the same IP address for the computer and other devices on the network, change the rightmost number when setting up the IP address assigned to the camera in the processes described on  462.

Example: 192.168.1.10

Wireless Communication Status

Wireless communication status can be checked on the screen and LCD panel.

Screen

Quick Control screen



- (1)
- (2)
- (3)

Information display screen during playback

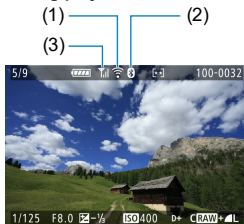





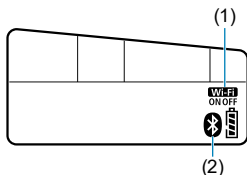









- (1)
- (2)
- (3)





LCD Panel



- (1) Wi-Fi function
- (2) Bluetooth function
- (3) Wireless signal strength

Communication Status		Screen		LCD Panel
		Wi-Fi Function	Wireless Signal Strength	Wi-Fi Function
Not connected	Wi-Fi: Disable		Off	
	Wi-Fi: Enable			
Connecting		 (Blinking)		 (Blinking)
Connected				
Sending data		 (↔)		
Connection error		 (Blinking)		 (Blinking)

Bluetooth Function Indicator

Bluetooth Function	Connection Status	Screen	LCD Panel
[Enable]	Bluetooth connected		
	Bluetooth not connected		
[Disable]	Bluetooth not connected	Not displayed	Not displayed



- “Bluetooth connected” status is indicated when connected to smartphones via Wi-Fi and during automatic image transfer to computers.
- “Bluetooth not connected” status is indicated when connected to computers, printers, or Web services via Wi-Fi.

Set-up

This chapter describes menu settings on the set-up ([F4]) tab.

- A ☆ icon to the right of a page title indicates that the function is available only in Creative Zone.

Tab Menus: Set-up

● Set-up 1

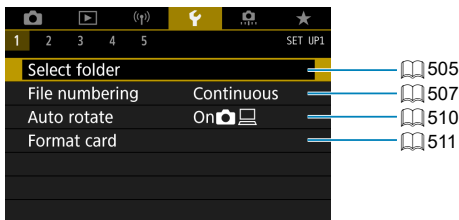

● Set-up 2

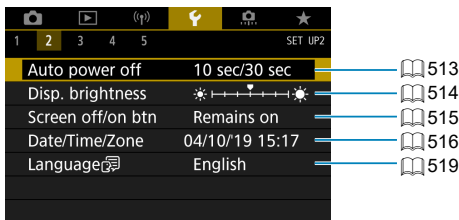

● Set-up 3

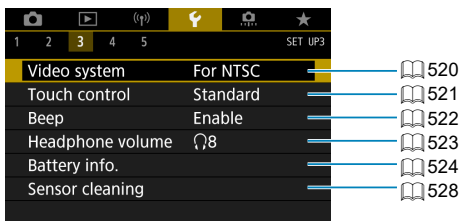

● Set-up 4

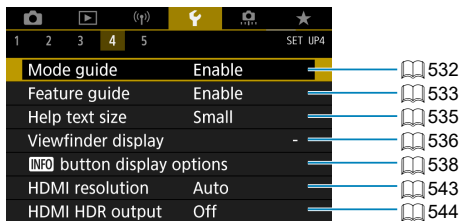

● Set-up 5

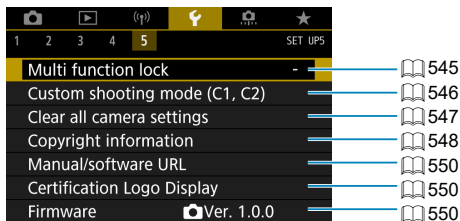

In Live View shooting, the following screen is displayed for [F4].

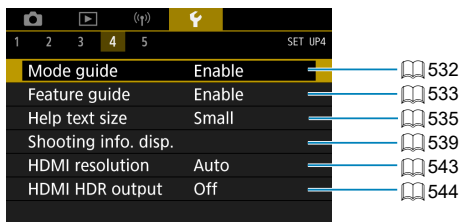

When you are recording movies, the following screen is displayed for [4].

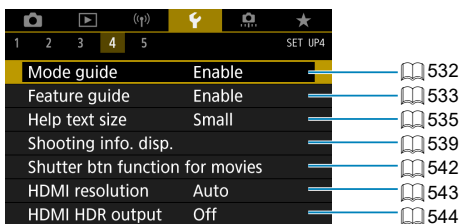

In Basic Zone and [HDR Movie] modes, the following screen is displayed for [5].

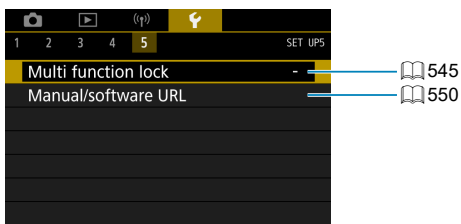

Creating and Selecting a Folder

You can freely create and select the folder where the captured images are to be saved.

Creating a Folder

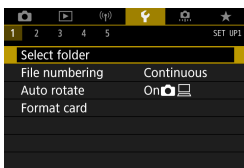

1 Select [Folder icon: Select folder].

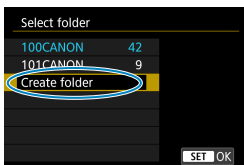

2 Select [Create folder].

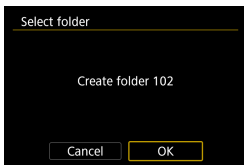

3 Select [OK].

Selecting a Folder

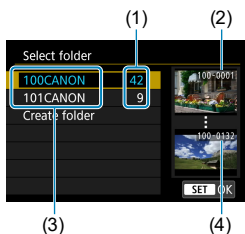

- Select a folder on the folder selection screen.
- Captured images are stored in your selected folder.

- (1) Number of images in folder
- (2) Lowest file number
- (3) Folder name
- (4) Highest file number



Folders

- A folder can contain up to 9999 images (file number 0001–9999). When a folder becomes full, a new folder with the folder number increased by one is created automatically. Also, if manual reset (📖 509) is executed, a new folder will be created automatically. Folders numbered from 100 to 999 can be created.

Creating Folders with a Computer

- With the card open on the screen, create a new folder named “DCIM”. Open the DCIM folder and create as many folders as necessary to save and organize your images. The folder name must follow the format “100ABC_D”. The first three digits are always the folder number from 100 to 999. The last five characters can be any combination of upper- and lower-case letters from A to Z, numerals, and the underscore “_”. The space cannot be used. Also note that two folder names cannot share the same three-digit folder number (for example, “100ABC_D” and “100W_XYZ”) even if the remaining five characters in each name are different.

File Numbering Methods

The captured images saved in a folder are assigned a file number from 0001 to 9999. You can change how the image files are numbered.

(Example) **IMG_0001.JPG**

File number

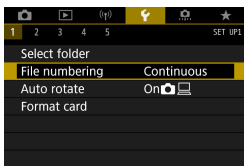

1 Select [**Y**: File numbering].

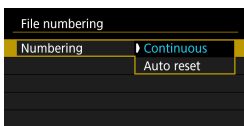

2 Set the item.

- Select [**Numbering**].
- Select [**Continuous**] or [**Auto reset**].

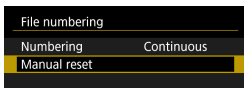

- If you want to reset the file numbering, select [**Manual reset**] (📖 509).
- Select [**OK**] to create a new folder, and the file number will start with 0001.

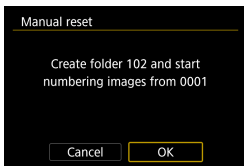

- If the file number in folder 999 reaches 9999, shooting will not be possible even if the card still has storage capacity. The screen will display a message telling you to replace the card. Replace it with a new card.

Continuous

When you wish to continue the file numbering sequence even after the card is replaced or a new folder is created.

Even after you replace the card or create a new folder, the file numbering continues in sequence up to 9999. This is useful when you want to save images numbered anywhere between 0001 to 9999 on multiple cards or in multiple folders into one folder on a computer.

If the replacement card or existing folder already contains images recorded previously, the file numbering of the new images may continue from the file numbering of the existing images on the card or in the folder. If you want to use continuous file numbering, it is recommended that you use a newly-formatted card each time.

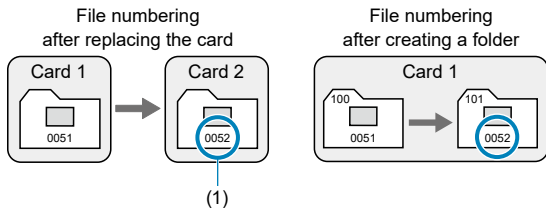

(1) Next sequential file number

Auto Reset

When you wish to restart the file numbering from 0001 each time the card is replaced or a new folder is created.

When you replace the card or create a folder, the file numbering restarts from 0001 for the new images saved. This is useful if you want to organize images by cards or folders.

If the replacement card or existing folder already contains images recorded previously, the file numbering of the new images may continue from the file numbering of the existing images on the card or in the folder. If you want to save images with the file numbering starting from 0001, use a newly formatted card each time.

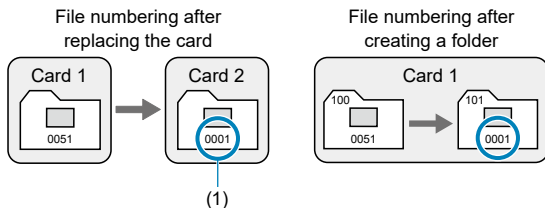

(1) File numbering is reset

Manual Reset

When you wish to reset the file numbering to 0001 or to start from file number 0001 in a new folder.

When you reset the file numbering manually, a new folder is created automatically and the file numbering of images saved to that folder starts from 0001.

This is useful, for example, if you want to use different folders for the images taken yesterday and the ones taken today.

The Auto Rotation of Vertical Images

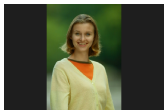

You can change the auto rotation setting that straightens images shot in vertical orientation when they are displayed.

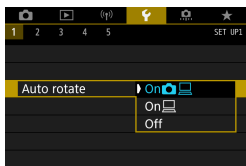

1 Select [: Auto rotate].

2 Select an item.

● **On**  

Automatically rotates images for display on both the camera and computers.

● **On** 

Automatically rotates images only for display on computers.

● **Off**

 ● Images captured with auto rotation set to **[Off]** will not rotate during playback even if you later set auto rotation to **[On]**.

 ● If a picture is taken while the camera is pointing up or down, automatic rotation to the proper orientation for viewing may not be performed correctly.
● If images are not rotated automatically on a computer, try using EOS software.

Formatting Memory Cards

If the card is new or was previously formatted (initialized) by another camera or computer, format the card with this camera.



- When the card is formatted, all images and data on the card will be erased. Even protected images will be erased, so make sure there is nothing you need to keep. If necessary, transfer the images and data to a computer, etc. before formatting the card.

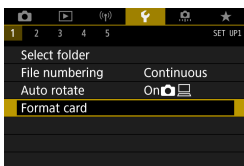

1 Select [: Format card].

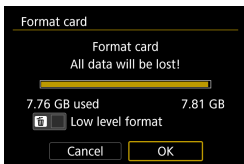

2 Format the card.

- Select [OK].

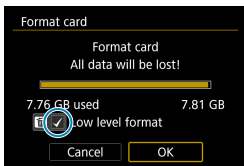

- For low-level formatting, press the button to add a checkmark to [Low level format], then select [OK].



- The card capacity displayed on the card format screen may be smaller than the capacity indicated on the card.
- This device incorporates exFAT technology licensed from Microsoft.

Conditions Requiring Card Formatting

- The card is new.
- The card was formatted by a different camera or a computer.
- The card is full of images or data.
- A card-related error is displayed ( 613).

Low-Level Formatting

- Perform low-level formatting if the card's writing or reading speed seems slow or if you want to totally erase the data on the card.
- Since low-level formatting will format all recordable sectors on the card, the formatting will take longer than normal formatting.
- During low-level formatting, you can cancel formatting by selecting **[Cancel]**. Even in this case, normal formatting will already be complete and you can use the card as usual.

Card's File Formats

- **SD/SDHC cards will be formatted in FAT32. SDXC cards will be formatted in exFAT.**
- When recording a movie with a card formatted in exFAT, the movie will be recorded in a single file (instead of being split into multiple files) even if it exceeds 4 GB. (The movie file will exceed 4 GB.)



- It may not be possible to use SDXC cards formatted with this camera in other cameras. Also note that exFAT-formatted cards may not be recognized by some computer operating systems or card readers.
- Formatting or erasing data on a card does not completely erase the data. Be aware of this when selling or discarding the card. When disposing of cards, take steps to protect personal information if necessary, as by physically destroying cards.

Auto Power Off

You can change the camera's auto power off time.

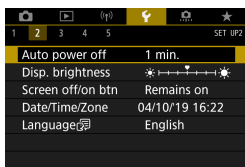

1 Select [**☽**: Auto power off].

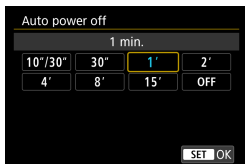

2 Select an item.



- The screen turns off in approx. 30 min. even when set to **[OFF]**. Note that the camera remains on.

Adjusting the Screen Brightness

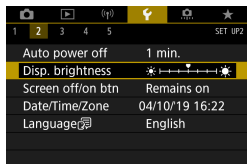

1 Select [**F**: Disp. brightness].

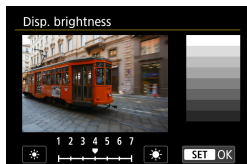

2 Make the adjustment.

- Referring to the gray chart, use the <◀> <▶> keys to adjust the brightness, then press <SET>.

- To check the image's exposure, referring to the histogram is recommended (389).

Turning the Screen Off/On

You can set the camera so that the screen turns off and on as you press the shutter button halfway in viewfinder shooting.

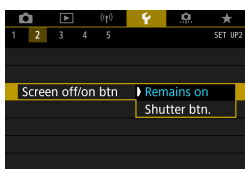

1 Select [**Y**: Screen off/on btn].

2 Select an item.

- **Remains on**

The screen does not turn off when you press the shutter button halfway. To turn off the screen, press the <INFO> button.

- **Shutter btn.**

The screen turns off when you press the shutter button halfway. To turn on the screen, release the button.

Setting the Date, Time, and Time Zone

When you turn on the power for the first time or if the date/time/zone have been reset, follow the steps below to set the time zone first.

By setting the time zone first, you can simply adjust this setting as needed in the future and the date/time will be updated to match it.

Since the captured images will be appended with the shooting date and time information, be sure to set your date/time.

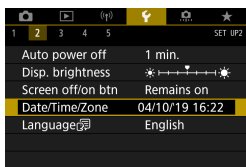

1 Select [**🕒**: Date/Time/Zone].

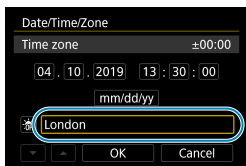

2 Set the time zone.

- Use the <◀> <▶> keys to select [**Time zone**].

- Press <Ⓢ>.

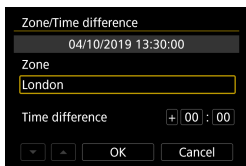

- Press <Ⓢ>.



- Use the <▲> <▼> keys to select the time zone, then press <Ⓢ>.

- If your time zone is not listed, press the <MENU> button, then set the difference from UTC in [**Time difference**].

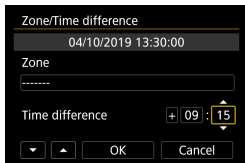

- Use the <◀> <▶> keys to select a **[Time difference]** item (+/-/hour/minute), then press <SET>.
- Use the <▲> <▼> keys to set it, then press <SET>.
- After entering the time zone or time difference, use the <◀> <▶> keys to select **[OK]**, then press <SET>.

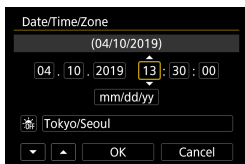



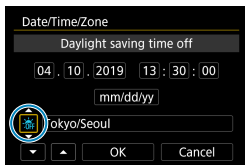

3 Set the date and time.

- Use the <◀> <▶> keys to select an item, then press <SET>.
- Use the <▲> <▼> keys to set it, then press <SET>.



4 Set the daylight saving time.

- Set it as necessary.
- Use the <◀> <▶> keys to select [>], then press <SET>.
- Use the <▲> <▼> keys to select [>], then press <SET>.
- When the daylight saving time is set to [>], the time set in step 3 will advance by 1 hour. If [>] is set, the daylight saving time will be canceled and the time will go back by 1 hour.

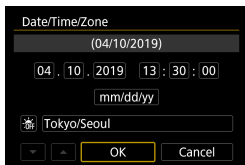

5 Exit the setting.

- Use the <◀> <▶> keys to select **[OK]**.





- The date, time, and time zone settings may be reset when the camera is stored without the battery, when its battery becomes exhausted, or when it is exposed to below freezing temperatures for a prolonged period. If this happens, set them once again.
- After changing **[Zone/Time difference]**, check that the correct date/time are set.

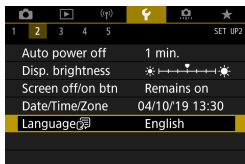

- Auto power off time may be extended while the **[⚡ : Date/Time/Zone]** screen is displayed.

Interface Language



1 Select [: Language ].



2 Set the desired language.

Video System

Set the video system of any television used for display. This setting determines the frame rates available when you record movies.

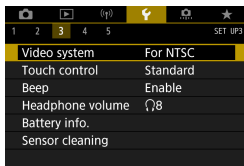

1 Select [**🔧**: Video system].

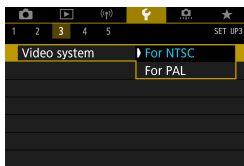

2 Select an item.

- **For NTSC**
For areas where the TV system is NTSC (North America, Japan, South Korea, Mexico, etc.).
- **For PAL**
For areas where the TV system is PAL (Europe, Russia, China, Australia, etc.).

Touch Sensitivity Settings

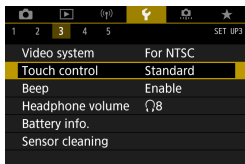

1 Select [**T**: Touch control].



2 Select an item.

- [**Sensitive**] provides a more reactive touch-screen panel response than [**Standard**].
- To disable touch operations, select [**Disable**].



Cautions for Touch Control Operations

- Do not use sharp objects such as fingernails or ballpoint pens for touch operations.
- Do not use wet fingers for touch operations. If the screen has any moisture or if your fingers are wet, the touch-screen panel may not respond or malfunction may occur. In this case, turn off the power and wipe off the moisture with a cloth.
- Attaching any commercially available protective sheet or sticker on the screen may degrade the touch operation response.
- If you quickly perform touch operation when [**Sensitive**] is set, the touch operation response may be poor.

Beeping for Camera Operations

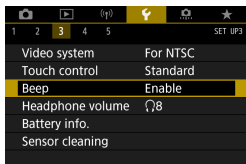

1 Select [: Beep].

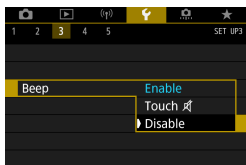

2 Select an item.

- **Touch** 
Disables beeping for touch operations.
- **Disable**
Disables beeping for focus confirmation, self-timer shooting, and touch operations.

Headphone Volume

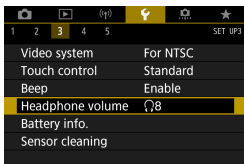

1 Select [**Y**: Headphone volume].

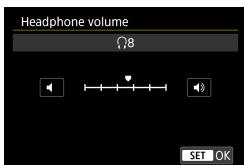

2 Make the adjustment.

- Use the <<<>>> keys to adjust it, then press <SET>.



- You can check sound from the built-in microphone or an external microphone on headphones when [**Camera**: **Sound recording**] is set to an option other than [**Disable**].

Checking the Battery Information

You can check the conditions of the battery you are using. By registering multiple batteries to the camera, you can check their approximate remaining capacity and usage history.

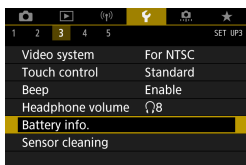

1 Select [🔋: Battery info.].

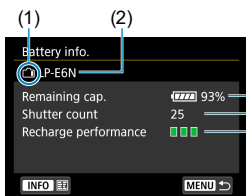

- (1) Battery position
- (2) Model of battery or household power source used.
- (3) The battery level indicator (📖 53) is displayed together with the remaining battery level shown in 1% increments.
- (4) The number of shots taken with the current battery. The number is reset when the battery is recharged.
- (5) Battery's recharge performance level is displayed.
 - 🟢🟢🟢 (Green) : Battery's recharge performance is good.
 - 🟢🟡🟡 (Green) : Battery's recharge performance is slightly degraded.
 - 🔴🔴🔴 (Red) : Purchasing a new battery is recommended.



- Using a genuine Canon Battery Pack LP-E6N/LP-E6 is recommended. If you use batteries that are not genuine Canon products, the camera's full performance may not be attained or malfunction may result.



- The shutter count is the number of still photos taken. (Movie recording is not counted.)
- Battery information is also displayed when you are using Battery Grip BG-E14 (sold separately) with LP-E6N/LP-E6 battery packs. With AA/R6 batteries, only the battery level is displayed.
- If a battery communication error message is displayed, follow the instructions in the message.

Battery Registration

You can register up to six LP-E6N/LP-E6 batteries to the camera. To register multiple batteries to the camera, follow the procedure below for each battery.

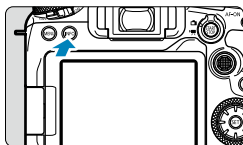

1 Press the <INFO> button.

- With the battery info. screen displayed, press the <INFO> button. If the battery is not registered, it will be grayed out.

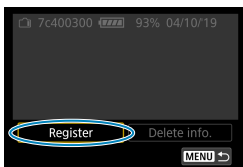

2 Select [Register].

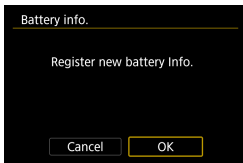

3 Select [OK].

- The battery is now displayed in white.



- The battery cannot be registered if the household power outlet accessories are used.

Labeling Batteries with Serial Numbers

It is convenient to label registered LP-E6N/LP-E6 battery packs with their serial numbers, using commercially available labels.

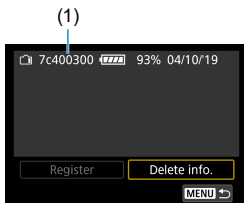

- 1** On a label approx. 25×15 mm, write the serial number (1).

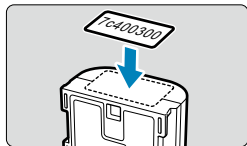

- 2** Apply the label.

- Set the power switch to <OFF>.
- Remove the battery from the camera.
- Apply the label as shown in the illustration (on the side with no electrical contacts).

- !**
- Do not apply the label on any part other than as shown in the illustration in step 2. Otherwise, the misplaced label may make it difficult to insert the battery or impossible to turn on the power.
 - When you use Battery Grip BG-E14 (sold separately), the label may peel off as you repeatedly insert and remove the battery into the battery magazine. If it peels off, apply a new label.

Checking the Remaining Capacity of a Registered Battery

You can check the remaining capacity of batteries not currently in use, as well as their last date of use.

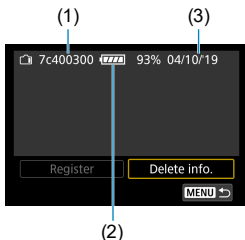

Look for the serial number.

- Refer to the battery's serial number label and look for the battery's serial number (1) on the battery history screen. You can check the respective battery's approximate remaining capacity (2) and the date when it was last used (3).

Deletion of Battery Information

- Select [Delete info.].**
 - Follow step 2 on 525 to select [Delete info.].
- Select the battery information to delete.**
 - [✓] will appear.
- Press the button.**
 - Select [OK] on the confirmation dialog.

Sensor Cleaning

Activating Immediate Cleaning

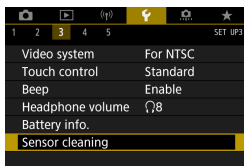

1 Select [**⚡**: Sensor cleaning].

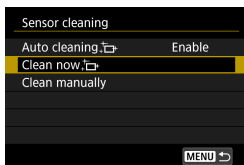

2 Select [**Clean now** ⚡].
● Select [**OK**] on the confirmation dialog.

Setting Auto Cleaning

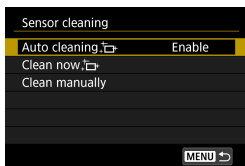

1 Select [**Auto cleaning**].

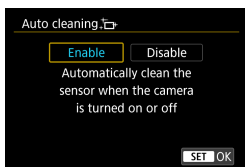

2 Select an item.

- Use the <<> <>> keys to select an item, then press <SET>.



- For best results, clean with the camera in a stable position on a desk or other flat surface.
- Even if you repeat the sensor cleaning, the result will not improve much. Note that [**Clean now**] may not be available immediately after cleaning.
- Dots of light may appear in captured images or on the shooting screen if the sensor is affected by cosmic rays or similar factors. By selecting [**Clean now**], their appearance may be suppressed (528).

Manual Sensor Cleaning ☆

Dust that could not be removed by automatic cleaning can be removed manually with a commercially available blower or similar tool.

Always use a fully charged battery.

The image sensor is extremely delicate. If the sensor needs to be cleaned directly, having it done by a Canon Service Center is recommended.

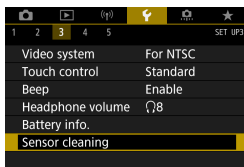

1 Select [**☚**: Sensor cleaning].

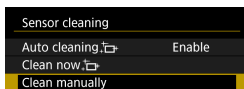

2 Select [**☚**: Clean manually].

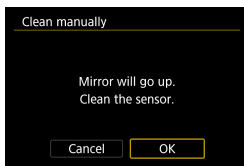

3 Select [**OK**].

- "CLn" will blink on the LCD panel.

4 Remove the lens and clean the sensor.

5 End the cleaning.

- Set the power switch to <OFF>.



- Using the household power outlet accessories (sold separately) is recommended.



- **While cleaning the sensor, never do any of the following. If the power is cut off, the shutter will close and the reflex mirror will go back down. These may result in damaging the image sensor, shutter curtains, and reflex mirror.**
 - **Setting the power switch to <OFF>.**
 - **Removing or inserting the battery.**
- The surface of the image sensor is extremely delicate. Clean the sensor with care.
- Use a plain blower without any brush attached. A brush can scratch the sensor.
- Do not insert the blower tip inside the camera beyond the lens mount. If the power is turned off, the shutter will close and the shutter curtains or reflex mirror may get damaged.
- Never use pressurized air or gas to clean the sensor. Pressurized air may damage the sensor, and sprayed gas may freeze on the sensor and scratch it.
- If the battery level becomes low while cleaning the sensor, the beeper will sound as a warning. Stop cleaning the sensor.
- If a smudge that cannot be removed with a blower remains, having the sensor cleaned by a Canon Service Center is recommended.

Displaying the Shooting Mode Guide

A brief description of the shooting mode can be displayed when you switch shooting modes.

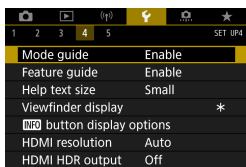

1 Select [**Mode guide**].

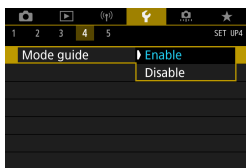

2 Select [**Enable**].

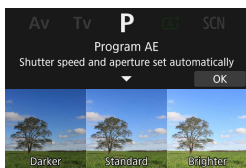

3 Turn the Mode dial.

- A brief description of the selected shooting mode is displayed.
- To display more details, press the <▼> key.
- To clear the mode guide, press <SET>. In <SCN> or <Q> mode, the shooting mode selection screen is displayed.

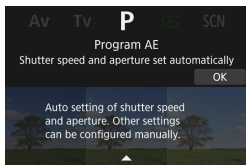

Feature Guide Display

A brief description of functions and items can be displayed when you use Quick Control setting.

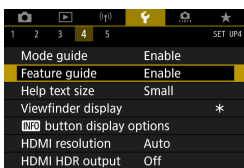

1 Select [**⚡**: Feature guide].

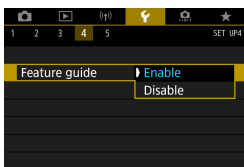

2 Select [**Enable**].

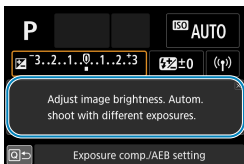

● To clear a description, either tap it or continue performing operations.

Help Features

When [**INFO Help**] is displayed, you can display a description about the feature by pressing the <INFO> button. Press it again to exit Help display. To scroll the screen when a scrollbar (1) appears on the right, turn the <◂◃> dial.

● Example: [**📷**: High ISO speed NR]

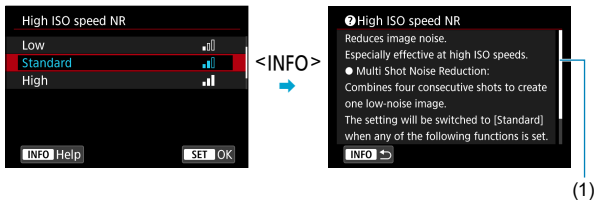

● Example: [**🔒**: Multi function lock]

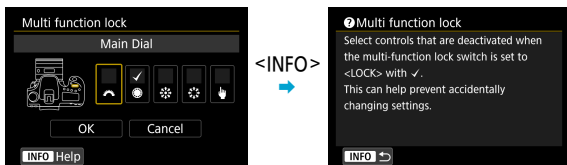

Text Size Adjustment

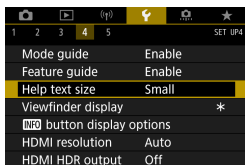

1 Select [**👉**: Help text size].



2 Select an item.

Customization of Information in the Viewfinder

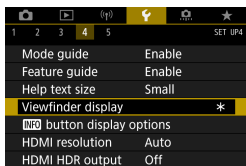

1 Select [**VIEW**]: Viewfinder display].

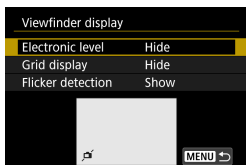

2 Select an item.

- Select with the <▲> <▼> keys, then press <SET>.

Electronic Level Display

The electronic level (1) appears when you press the shutter button halfway. This level also works with vertical shooting.

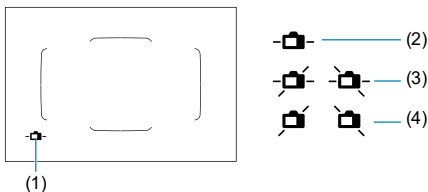

(2) Horizontal

(3) Tilted 1°

(4) Tilted 2° or more



- Only horizontal tilt can be checked. (Forward/backward tilt is not displayed.)
- There may be a margin of error of approx. $\pm 1^\circ$.



- An asterisk next to [**Viewfinder display**] indicates that the default viewfinder display setting has been changed.

Grid Display

You can display a grid in the viewfinder to help you check the camera tilt or compose the shot.



- You can display a grid on the screen during Live View shooting and before you start recording a movie (📖 540).

Displaying the Flicker Detection ☆

If you set this function, < **Flicker!** > will appear in the viewfinder when the camera detects flicker caused by the blinking of the light source.



- If you set [**Anti-flicker shoot.**] to [**Enable**], you can shoot with reduced unevenness of exposure caused by the flicker (📖 261).

<INFO> Button Display Options

You can select the information displayed on the screen in response to pressing the <INFO> button when the camera is ready to shoot.

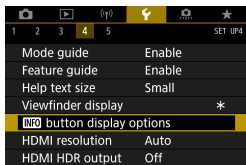

- 1 Select [**INFO** button display options].

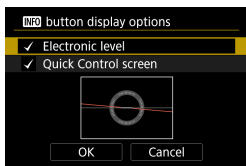

- 2 Select an item.
 - Select the desired display option, then add a checkmark [**✓**].
 - Select [**OK**].

Electronic Level Display

The red line turns green when the image is essentially straight.

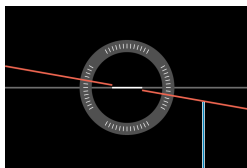

Horizontal

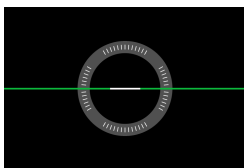

- There may be a margin of error of approx. $\pm 1^\circ$.
- If the camera is very tilted, the electronic level's margin of error will be larger.

- The electronic level is not displayed in Live View shooting when the AF method is set to [**L+Tracking**].
- For [**Quick Control screen**], see 622.

Customization of On-Screen Information

You can customize on-screen display in Live View shooting or movie recording.

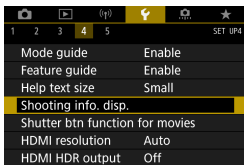

Select [**Y**: Shooting info. disp.].

Customizing Information on the Screen

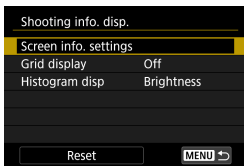

1 Select [**Screen info. settings**].

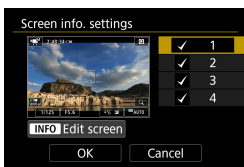

2 Select screens.

- Use the <▲> <▼> keys to select screens of information to show on the camera.
- For information you prefer not to display, press <SET> to clear the checkmark [**✓**].
- To edit the screen, press the <INFO> button.

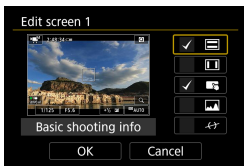

3 Edit the screen.

- Use the <▲> <▼> keys to select items to show on the screen.
- For items you prefer not to display, press <SET> to clear the checkmark [**✓**].
- Select [**OK**] to register the setting.

Grid Display

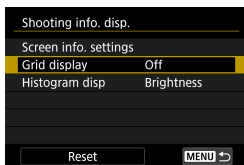

1 Select [Grid display].

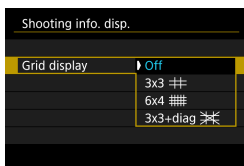

2 Select an item.

Setting the Histogram

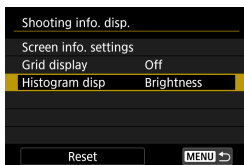

1 Select [Histogram disp].



2 Select an item.

- Select the content ([**Brightness**] or [**RGB**]) and display size ([**Large**] or [**Small**]).
- Press <MENU> button to confirm the setting.

Clearing Settings

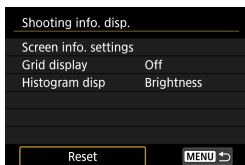

1 Select [Reset].

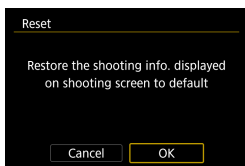

2 Select [OK].

Shutter Button Customization for Movie Recording

You can set the functions performed by pressing the shutter button halfway or completely during movie recording.

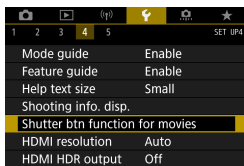

1 Select [**⏏**: Shutter btn function for movies].

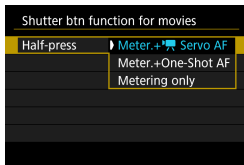

2 Select an item.

- **Half-press**

Specify the function performed by pressing the shutter button halfway.

- **Fully-press**

Specify the function performed by pressing the shutter button completely.

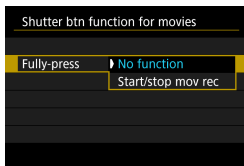

With [**Fully-press**] set to [**Start/stop mov rec**], you can start/stop movie recording not only by pressing the movie shooting button but also by pressing the shutter button completely or by using Remote Controller RC-6, Wireless Remote Control BR-E1, or Remote Switch RS-60E3.



- Even if you set [**Fully-press**] to [**No function**], the camera will start or stop recording time-lapse movies if the shutter button is pressed completely when the camera is set up for time-lapse movies.

HDMI Output Resolution

Set the image output resolution used when the camera is connected to a television or external recording device with an HDMI cable.

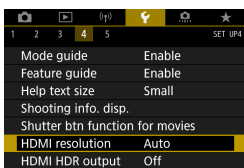

1 Select [**Y**: HDMI resolution].

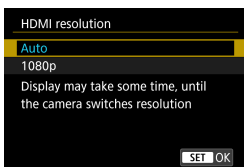

2 Select an item.

- **Auto**

The images will automatically be displayed at the optimum resolution matching the connected television.

- **1080p**

Output at 1080p resolution. Select if you prefer to avoid display or delay issues when the camera switches resolution.

RAW Image Display on HDR TVs

You can view RAW images in HDR by connecting the camera to an HDR TV.

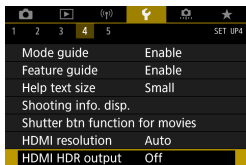

1 Select [**⏏**: HDMI HDR output].

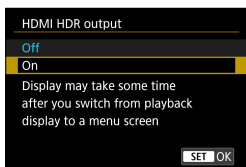

2 Select [**On**].

- ! Image operations such as RAW processing are not available during HDR display.
- ! JPEG images are used for HDR display in the case of multiple-exposure RAW images.

- ! Make sure the HDR TV is set up for HDR input. For details on how to switch inputs on the TV, refer to the TV manual.
- ! Depending on the TV used, images may not look as expected.
- ! Some image effects and information may not be displayed on an HDR TV.

Multi-Function Lock

Specify camera controls to lock when the Multi-function lock is enabled. This can help prevent accidentally changing settings.

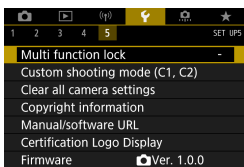

1 Select []: Multi function lock].



2 Select camera controls to lock.

- Press <SET> to add a checkmark [].
- Select [**OK**].
Setting the <LOCK> switch to <LOCK> locks the selected [] camera controls.



- In Basic Zone modes, only [**Touch control**] can be set. Note that in <> mode, you can also use the <> or <> dial.
- If it is changed from the default setting, an asterisk “*” will be displayed on the right edge of [**Multi function lock**].

Registering Custom Shooting Modes



Current camera settings such as shooting, menu, and Custom Function settings can be registered as Custom shooting modes.

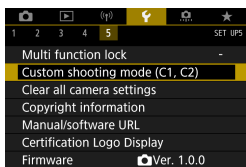

- 1** Select [**Y**]: Custom shooting mode (C1, C2)].

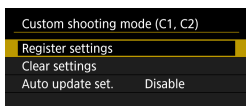

- 2** Select [Register settings].

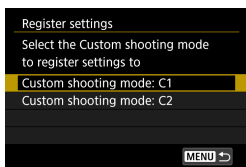

- 3** Register the desired items.
- On the [Register settings] screen, select [**C***], then press <[SET]>.
 - Select [OK] on the [Custom shooting mode: C*] screen.
- The current camera settings are registered to Custom shooting mode C*.

Automatic Update of Registered Settings

If you change a setting while shooting in Custom shooting mode, the mode can be automatically updated with the new setting (Auto update). To enable this automatic update, set [Auto update set.] to [Enable] in step 2.

Canceling Registered Custom Shooting Modes

If you select [Clear settings] in step 2, the settings of respective modes can be reverted to the default settings with no Custom shooting modes registered.



- You can also change shooting and menu settings in Custom shooting modes.

Restoring Camera Defaults



The camera's settings for shooting functions and menu functions can be restored to their defaults.

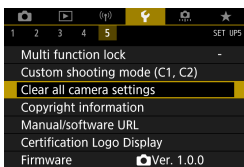

1 Select [**Y**: Clear all camera settings].

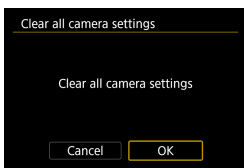

2 Select [OK].



- For details on clearing all Custom Function and customized control settings, see 581.

Copyright Information



When you set the copyright information, it will be recorded to the image as Exif information.

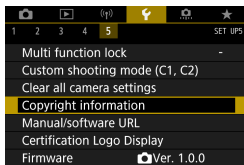

1 Select [**5**: Copyright information].



2 Select an item.

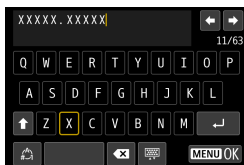

3 Enter text.

- Use <⊕> <⊖> or the <⊙> dial to select a character, then press <SET> to enter it.
- By selecting [**⊕**], you can change the input mode.
- To delete single characters, select [**X**] or press the <⊗> button.

4 Exit the setting.

- Press the <MENU> button, then press [OK].

Checking the Copyright Information

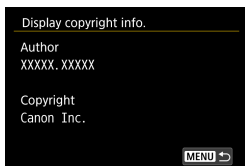

When you select **[Display copyright info.]** in step 2, you can check the **[Author]** and **[Copyright]** information that you entered.

Deleting the Copyright Information

When you select **[Delete copyright information]** in step 2, you can delete the **[Author]** and **[Copyright]** information.



- If the entry for "Author" or "Copyright" is long, it may not be displayed entirely when you select **[Display copyright info.]**.



- You can also set or check the copyright information with EOS Utility (EOS software).

Other Information

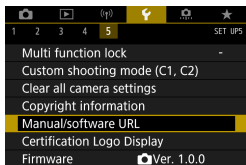

● Downloading instruction manuals or software

To download instruction manuals, select [**☛ : Manual/software URL**] and scan the displayed QR code with a smartphone.

You can also use a computer to access the website at the URL displayed and download software.

● Displaying certification logos ☆

Select [**☛ : Certification Logo Display**] to display some of the logos of the camera's certifications. Other certification logos can be found in this Instruction Manual, on the camera body, and on the camera's package.

● Firmware version ☆

Select [**☛ : Firmware**] to update the firmware of the camera or current lens.

Custom Functions / My Menu

You can fine-tune camera functions and change the functionality of buttons and dials to suit your shooting preferences. You can also add menu items and Custom Functions that you adjust frequently to My Menu tabs.

Tab Menus: Customization

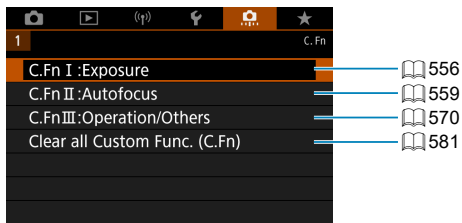

Setting Custom Functions

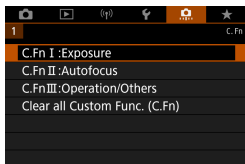

- 1** Select [C.Fn I:Exposure], [C.Fn II:Autofocus], or [C.Fn III:Operation/Others].

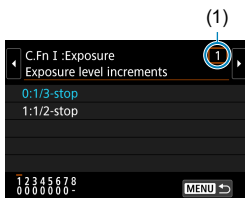

- 2** Select a Custom Function number.
- Use the <◀> <▶> keys to select the Custom Function number (1) to set up.

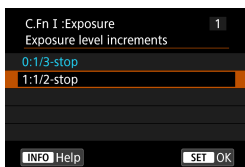

- 3** Change the setting as desired.
- Use the <▲> <▼> keys to select a setting (number).
 - To set up another Custom Function, repeat steps 2–3.

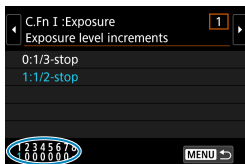

- At the bottom of the screen, the current Custom Function settings are indicated below the respective function numbers.
- Any options changed from defaults are displayed in blue.

- 4** Exit the setting.
- Press the <MENU> button. The screen in step 1 is displayed again.

Custom Functions



Custom Functions indicated by have no effect (the setting is disabled) in Live View (LV) shooting and movie recording.

C.Fn I: Exposure

1	Exposure level increments	556
2	ISO speed setting increments	556
3	Bracketing auto cancel	556
4	Bracketing sequence	557
5	Number of bracketed shots	557
6	Safety shift	558
7	Exposure compensation auto cancel	558
8	AE lock metering mode after focus	558

LV Shooting	Movie Recording
○	○
○	M mode
○	
○	
○	
○	
○	
○	







C.Fn II: Autofocus



1	Tracking sensitivity	559
2	Acceleration/deceleration tracking	560
3	AF point auto switching	561
4	AI Servo 1st image priority	561
5	AI Servo 2nd image priority	562
6	Lens drive when AF impossible	563
7	Select AF area selection mode	563
8	Limit AF methods*	564
9	AF area selection method	564
10	Orientation linked AF point	565
11	Initial Servo AF point, /	566
12	Auto AF point selection: EOS ITR AF	567
13	AF point selection movement	568
14	AF point display during focus	568
15	Viewfinder display illumination	569
16	AF Microadjustment	569

LV Shooting	Movie Recording
○	
○	
○	
○	○
○	○
○	
○	

* Function used for Live View shooting.

C.Fn III: Operation/Others

1	Warnings  in viewfinder	 570
2	Dial direction during Tv/Av	 570
3	Custom Controls	 571
4	Retract lens on power off	 574
5	Audio compression	 574

 LV Shooting	 Movie Recording
○	○
Varies by settings	
○	○
	○

Custom Function Setting Items



You can customize camera features on the [Fn] tab to suit your shooting preferences.

C.Fn I: Exposure

C.Fn I-1: Exposure level increments

Sets 1/2-stop increments for the shutter speed, aperture, exposure compensation, AEB, flash exposure compensation, etc.

- 0: 1/3-stop
- 1: 1/2-stop



- When [1/2-stop] is set, the display will be as shown below.

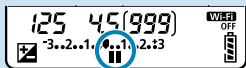

C.Fn I-2: ISO speed setting increments

You can change the manual ISO speed setting increments to a whole-stop.

- 0: 1/3-stop
- 1: 1-stop



- Even if [1-stop] is set, ISO speed will be automatically set in 1/3-stop increments when ISO Auto is set.

C.Fn I-3: Bracketing auto cancel

You can specify to cancel AEB and white balance bracketing when the power switch is set to <OFF>.

- 0: Enable
- 1: Disable

C.Fn I-4: Bracketing sequence

The AEB shooting sequence and white balance bracketing sequence can be changed.

- 0: 0, -, +
- 1: -, 0, +
- 2: +, 0, -

AEB	White Balance Bracketing	
	B/A Direction	M/G Direction
0 : Standard exposure	0 : Standard white balance	0 : Standard white balance
- : Underexposure	- : Blue bias	- : Magenta bias
+ : Overexposure	+ : Amber bias	+ : Green bias

C.Fn I-5: Number of bracketed shots

The number of shots taken with AEB and white balance bracketing can be changed.

When [**Bracketing sequence**] is set to [0, -, +], the bracketed shots will be taken as shown in the table below.

- 0: 3 shots
- 1: 2 shots
- 2: 5 shots
- 3: 7 shots

(1-stop/step increments)

	1st Shot	2nd Shot	3rd Shot	4th Shot	5th Shot	6th Shot	7th Shot
3: 3 shots	Standard (0)	-1	+1				
2: 2 shots	Standard (0)	±1					
5: 5 shots	Standard (0)	-2	-1	+1	+2		
7: 7 shots	Standard (0)	-3	-2	-1	+1	+2	+3



- If [2 shots] is set, you can select the + or - side when setting the AEB range. With WB bracketing, the 2nd shot will be adjusted toward either the B/A or M/G direction.

C.Fn I-6: Safety shift

If the subject brightness changes and the standard exposure cannot be obtained within the autoexposure range, the camera will automatically change the manually selected setting to obtain the standard exposure. When set to **[Shutter speed/Aperture]**, this setting applies to <Tv> and <Av> modes. When set to **[ISO speed]**, this setting applies to <P>, <Tv>, and <Av> modes.

- 0: Disable
- 1: Shutter speed/Aperture
- 2: ISO speed



- Under **[📷: 📷 ISO speed settings]**, even if **[ISO speed range]** or **[Min. shutter spd.]** is changed from the default setting, safety shift will override it if the standard exposure cannot be obtained.
- The minimum and maximum limits for the safety shift with the ISO speed are determined by **[Auto range]** (📖 216). However, if the manually set ISO speed exceeds the **[Auto range]**, the safety shift will take effect up or down to the manually set ISO speed.
- Safety shift will take effect as necessary even when flash is used.

C.Fn I-7: Exposure compensation auto cancel

- 0: Disable
The exposure compensation setting will not be canceled even if you set the power switch to <OFF>.
- 1: Enable
When you set the power switch to <OFF>, the exposure compensation setting will be canceled.

C.Fn I-8: AE lock metering mode after focus

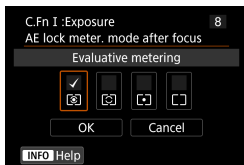

For each metering mode, you can specify whether to lock the exposure (AE lock) once subjects are in focus with One-Shot AF. The exposure will be locked while you keep pressing the shutter button halfway. Select metering modes for AE lock and add a checkmark [✓]. Select **[OK]** to register the setting.

C.Fn II: Autofocus

C.Fn II-1: Tracking sensitivity

You can set the subject-tracking sensitivity, which affects responsiveness to interfering objects that move across AF points or subjects that stray from AF points during AI Servo AF/Servo AF.

- 0

Standard setting. Suitable for moving subjects in general.

- Locked on: -2 / Locked on: -1

The camera will try to continue focusing on the subject even if an obstacle cuts across the AF points or if the subject strays from the AF points. The -2 setting makes the camera keep tracking the target subject longer than the -1 setting.

However, if the camera focuses on a wrong subject, it may take slightly longer to switch and focus on the target subject.

- Responsive: +2 / Responsive: +1

The camera can focus consecutively on subjects at different distances that are covered by the AF points. Also effective when you want to always focus on the closest subject. The +2 setting is more responsive than the +1 setting when focusing on the next subject.

However, the camera will be more prone to focus on an unintended subject.

C.Fn II-2: Acceleration/deceleration tracking

Sets the AI Servo AF/Servo AF tracking sensitivity for subjects that change speed suddenly, as by suddenly moving or stopping.

- 0
Suited for subjects that move at a steady speed (minor changes in moving speed).
- -2 / -1
Suited for subjects that move at a steady speed (minor changes in moving speed). Effective when a setting of 0 makes focus unstable, due to slight subject movement or an obstruction in front of the subject.
- +2 / +1
Effective for subjects having sudden movements, sudden acceleration/ deceleration, or sudden stops. Even if the moving subject's speed suddenly changes dramatically, the camera continues to focus on the target subject. For example, the camera is less likely to focus behind a subject that suddenly starts approaching you, or in front of an approaching subject that suddenly stops moving. Setting +2 can track dramatic changes in the moving subject's speed better than with +1. However, since the camera will be sensitive to even slight movements of the subject, focusing may become unstable for short periods.

C.Fn II-3: AF point auto switching

This sets the switching sensitivity of the AF points as they track the subject moving dramatically up, down, left, or right.

Applies in **[Auto selection AF]**, **[Zone AF]**, or **[Large Zone AF]** AF area selection modes, or with **[L +Tracking]** or **[Zone AF]** AF methods.

- 0

Standard setting for gradual AF point switching.

- +2 / +1

Even if the target subject moves dramatically up, down, left, or right and moves away from the AF point, the camera switches its focus to neighboring AF points to continue focusing on the subject. The camera switches to the AF point deemed most likely to focus on the subject based on the subject's continual movement, contrast, etc. Setting +2 makes the camera more prone to switch the AF point than with +1. However, with a wide-angle lens having a wide depth of field or if the subject is too small in the frame, the camera may focus with an unintended AF point.

C.Fn II-4: AI Servo 1st image priority

You can set the AF operation characteristics and shutter-release timing for the first shot with AI Servo AF.

- Equal priority

Equal priority is given to focusing and shutter release.

- Release priority

Pressing the shutter button takes the picture immediately even if focus has not been achieved. Useful when you want to give priority to capturing the decisive moment rather than achieving focus.

- Focus priority

Pressing the shutter button does not take the picture until focus is achieved. Useful when you want to achieve focus before capturing the image.

C.Fn II-5: AI Servo 2nd image priority

With AI Servo AF for continuous shooting, you can preset the AF operation characteristics and shutter-release timing for the subsequent shots after the first shot in continuous shooting.

- **Equal priority**
Equal priority is given to focusing and continuous shooting speed. In low light or with low-contrast subjects, continuous shooting speed may slow down.
- **Shooting speed priority**
Priority is given to the continuous shooting speed instead of achieving focus.
- **Focus priority**
Priority is given to achieving focus instead of the continuous shooting speed. The picture will not be taken until focus is achieved.



- Even if **[Shooting speed priority]** is set, under shooting conditions that activate flicker reduction (📖 261), the continuous shooting speed may become slower or the shooting interval may become irregular.



- If focus cannot be achieved in low-light conditions when **[Equal priority]** is set, setting **[Focus priority]** may give better results.

C.Fn II-6: Lens drive when AF impossible

You can specify lens operation in cases when the camera cannot autofocus on a subject.

- 0: Continue focus search

If focus cannot be achieved with autofocus, the lens is driven to search for the precise focus.

- 1: Stop focus search

If autofocus starts and the focus is far off or if focus cannot be achieved, the lens drive will not be performed. This prevents the lens from becoming grossly out of focus due to the focus search drive.



- **[1:Stop focus search]** is recommended for super telephoto lenses or other lens that cover a large area, to avoid significant delay from focus search drive if the lens becomes greatly out of focus.

C.Fn II-7: Select AF area selection mode

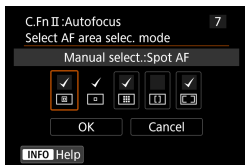

You can limit the selectable AF area selection modes to suit your shooting preferences. Select the desired AF area selection mode and press $\langle \text{SET} \rangle$ to add a checkmark [✓]. Select [OK] to register the setting.



The AF area selection modes are described on 128– 129.



- The [✓] mark cannot be removed from **[Manual selection:1 pt AF]**.
- You cannot use certain AF area selection modes even if you add a checkmark [✓] in **[Select AF area selec. mode]**.

C.Fn II-8: Limit AF methods

You can limit the AF methods available to those that you will use.

For details on AF methods, see  135– 137.



Add a checkmark [✓] to the AF methods to make available. Select [OK] to register the setting.







- The [✓] mark cannot be removed from [1-point AF].

C.Fn II-9: AF area selection method



- 0:  → AF area selection button

After you press the <> or <> button, pressing the <> button will change the AF area selection mode.

- 1:  → Main Dial

After you press the <> or <> button, turning the <> dial will change the AF area selection mode.



- When [1:  → Main dial] is set, use <> <> to move the AF point horizontally.

C.Fn II-10: Orientation linked AF point

- 0: Same for both vertic./horiz.

The same AF area selection mode or manually selected AF points (or AF points or Zone AF frames in the same position) are used for both vertical shooting and horizontal shooting.

- 1: Separate AF pts:  +  ( in LV)



The AF area selection mode and AF point or zone AF frame can be set separately for each camera orientation (1. Horizontal, 2. Vertical with the camera grip at the top, 3. Vertical with the camera grip at the bottom). When you manually select the AF area selection mode and AF point (or zone) for each of the three camera orientations, they will be registered for the respective orientation. Whenever you change the camera orientation during shooting, the camera will switch to the AF area selection mode and manually-selected AF point or zone AF frame set for that orientation.

- 2: Separate AF pts:  only

Separate AF point or Zone AF frame positions can be assigned for each camera orientation (1. Horizontal, 2. Vertical with the camera grip above, 3. Vertical with the camera grip below). Useful when switching to AF points or Zone AF frames in other positions automatically based on camera orientation.

AF points or Zone AF frames assigned to each of the three camera orientations are retained.



- If []: **Clear all Custom Func. (C.Fn)**] is selected ( 581), the settings for the 1., 2., and 3. orientations will be cleared.
- Setting may be cleared if a lens not used at the time of setup is attached.

C.Fn II-11: Initial Servo AF point, (C)/AF

You can set the initial AF point for AI Servo AF or Servo AF when the AF area selection mode is set to **[Auto selection AF]**, or when the AF method is set to **[AF+Tracking]**.

- 0: Auto

The AF point that AI Servo AF or Servo AF starts with is set automatically to suit the shooting conditions.

- 1: Initial Servo AF pt for (C)/AF

AI Servo AF or Servo AF starts from the manually set AF point when AF operation is set to **[AI Servo AF]** and the AF area selection mode to **[Auto selection AF]**, or when AF operation is set to **[Servo AF]** and the AF method to **[AF+Tracking]**.

- 2: AF pt set for []

If you switch from **[Spot AF]** or **[1-point AF]** to **[Auto selection AF]** or **[AF+Tracking]**, AI Servo AF or Servo AF starts from the AF point that was manually set before switching. Useful for starting AI Servo AF or Servo AF from the AF point set before switching to **[Auto selection AF]** or **[AF+Tracking]**.

C.Fn II-12: Auto AF point selection: EOS iTR AF

Use this function to autofocus in viewfinder shooting by recognizing people. This function works when the AF area selection mode is set to Zone AF (manual selection of zone), Large Zone AF (manual selection of zone), or Automatic selection AF.

- 0: EOS iTR AF (Face priority)

Faces are given greater priority than with **[1:Enable]** when the camera selects AF points.

In One-Shot AF mode, this makes it easier to focus on faces of still human subjects in the AF area.

Also makes it easier to focus on faces in the AF area in AI Servo AF mode.

Once focus is achieved, AF points are automatically selected to keep focusing on the faces initially in focus.

- 1: Enable

The camera selects AF points automatically based on AF information and information on recognized people.

In One-Shot AF mode, focusing on a still human subject in the AF area is made easier.

In AI Servo AF mode, focusing on a human subject in the AF area is made easier. If no people are detected, the camera focuses on the nearest subject. Once focus is achieved, AF points are automatically selected so that the camera continues to focus on the color of the area it focused on first.

- 2: Disable

AF points are automatically selected based only on AF information.



- With setting **[0:EOS iTR AF (Face priority)]** or **[1:Enable]**, focusing will take slightly longer than with setting **[2:Disable]**.
- Even with setting **[0:EOS iTR AF (Face priority)]** or **[1:Enable]**, the expected result may not be obtained depending on the shooting conditions and subject.
- Under low light, where external Speedlites for EOS cameras automatically emit an AF-assist beam, AF points are selected automatically based only on AF information. (Information on recognized people is not used for AF.)

C.Fn II-13: AF point selection movement (Viewfinder shooting)

- 0: Stops at AF area edges
Useful if you often use the AF point at the outer edge.
- 1: Continuous
Instead of stopping at the outer edge, the selection of AF point continues to the opposite side.



- Also applies when the initial AF point for AI Servo AF is selected with [C.Fn II-11: Initial Servo AF pt, (○)/3:33] set to [1:Initial AF pt set for (○)/3:33].

C.Fn II-14: AF point display during focus (Viewfinder shooting)

You can set whether to display the AF point(s) when AF point is selected, before AF starts (shooting ready), when AF starts, during AF, when focus is achieved, and when the metering timer is active after focus is achieved.

○: Displayed, ×: Not displayed

AF Point Display During Focus	With AF Point Selected	Before AF Starts (Shooting Ready)	At AF Start
0: Selected (constant)	○	○	○
1: All (constant)	○	○	○
2: Selected (pre-AF,focused)	○	○	○
3: Selected AF pt (focused)	○	×	○
4: Disable display	○	×	×

AF Point Display During Focus	During AF	Focus Achieved	Metering Active After Achieving Focus
0: Selected (constant)	○	○	○
1: All (constant)	○	○	○
2: Selected (pre-AF,focused)	×	○	○
3: Selected AF pt (focused)	×	○	×
4: Disable display	×	×	×

C.Fn II-15: Viewfinder display illumination

- 0: Auto

The AF points achieving focus in low light or with a dark subject will automatically light up in red.

- 1: Enable

The AF points light up in red regardless of the ambient light level.

- 2: Disable

The AF points do not light up in red.

With **[Auto]** or **[Enable]** set, you can set whether the AF points are to light up in red when you press the <Q> button during AI Servo AF.

- OFF: Non illuminated

The AF points will not light up during AI Servo AF.

- ON: Illuminated

The AF points used for focusing light up in red during AI Servo AF. The AF points also light up during continuous shooting.

If set to **[2:Disable]**, this function will not work.



- When you press the <Fn> or <Fn2> button, the AF points will light up in red regardless of this setting.
- The aspect ratio lines, electronic level, and grid in the viewfinder will also light up in red.

C.Fn II-16: AF Microadjustment





You can make fine adjustments for the AF's point of focus (📖 575).



C.Fn III: Operation/Others

C.Fn III-1: Warnings in viewfinder

When any of the following functions are set, the  icon can be displayed in the viewfinder and on the LCD panel (📖 34).





Select the function for which you want the warning icon to appear, then press  to add a checkmark [✓]. Select [OK] to register the setting.

- When monochrome  set
 - If [: **Picture Style**] is set to [**Monochrome**] (📖 231), the warning icon will appear.
- When WB is corrected
 - If white balance correction is set (📖 227), the warning icon will appear.
- When  is set
 - If [: **High ISO speed NR**] is set to [**Multi Shot Noise Reduction**] (📖 238), the warning icon will appear.
- When HDR is set
 - If [: **HDR mode**] is set (📖 251), the warning icon will appear.

 ● If you set any of the checkmarked [✓] functions,  will also appear for the respective setting displayed on the Creative Zone screen (📖 67).

C.Fn III-2: Dial direction during Tv/Av

Dial turning direction when setting the shutter speed and aperture can be reversed.

In the **<M>** shooting mode, the turning direction of the  and  dial will be reversed. In other shooting modes, the turning direction of only the  dial will be reversed. The direction of the  dial in **<M>** mode matches the direction to set exposure compensation in **<P>**, **<Tv>**, and **<Av>** modes.

- 0: Normal
- 1: Reverse direction

C.Fn III-3: Custom Controls

You can assign frequently used functions to camera buttons or dials according to your preferences for easy operations.

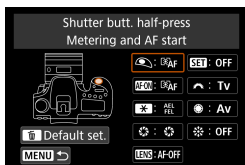

1 Select a part of the bar.























2 Select a function to assign.





- Press <SET> to set it.



- With the screen in step 1 displayed, you can press the <Clear> button to revert the Custom Control settings to their defaults. Customized operations are not cleared if you select **[Clear all Custom Func. (C.Fn)]**.

Functions Available for Camera Controls

		Function		AF-ON
AF		Metering and AF start	<input type="radio"/>	<input type="radio"/>
	AF-OFF	AF stop	<input type="checkbox"/>	<input type="radio"/>
		ONE SHOT ↔ AI SERVO/SERVO	<input type="checkbox"/>	<input type="radio"/>
		Direct AF point selection	<input type="checkbox"/>	<input type="checkbox"/>
		Pause Movie Servo AF	<input type="checkbox"/>	<input type="checkbox"/>
Exposure		Metering start	<input type="radio"/>	<input type="checkbox"/>
	AEL FEL	AE lock/FE lock	<input type="checkbox"/>	<input type="radio"/>
		AE lock (hold)	<input type="checkbox"/>	<input type="radio"/>
		AE lock	<input type="checkbox"/>	<input type="radio"/>
		AE lock (while button pressed)	<input type="radio"/>	<input type="checkbox"/>
	FEL	FE lock	<input type="checkbox"/>	<input type="radio"/>
	ISO 	Set ISO speed (hold button, turn )	<input type="checkbox"/>	<input type="radio"/>
		Exposure compensation (hold button, turn )	<input type="checkbox"/>	<input type="radio"/>
		Flash exposure compensation	<input type="checkbox"/>	<input type="checkbox"/>
	Tv	Shutter speed setting in M mode	<input type="checkbox"/>	<input type="checkbox"/>
Av	Aperture setting in M mode	<input type="checkbox"/>	<input type="checkbox"/>	
Image		Image quality	<input type="checkbox"/>	<input type="checkbox"/>
		Picture Style	<input type="checkbox"/>	<input type="checkbox"/>
	WB	White balance	<input type="checkbox"/>	<input type="checkbox"/>
		Create folder	<input type="checkbox"/>	<input type="checkbox"/>
Operation		Depth-of-field preview	<input type="checkbox"/>	<input type="checkbox"/>
		IS start	<input type="checkbox"/>	<input type="checkbox"/>
	MENU	Menu display	<input type="checkbox"/>	<input type="checkbox"/>
		Flash function settings	<input type="checkbox"/>	<input type="checkbox"/>
		Wi-Fi/Bluetooth connection	<input type="checkbox"/>	<input type="checkbox"/>
	OFF	No function (disabled)	<input type="checkbox"/>	<input type="radio"/>

		LENS	SET			
<input type="radio"/>		<input type="radio"/>				
<input type="radio"/>	<input type="radio"/>	<input type="radio"/>				
<input type="radio"/>	<input type="radio"/>	<input type="radio"/>				
						<input type="radio"/>
			<input type="radio"/>			
<input type="radio"/>	<input type="radio"/>	<input type="radio"/>				
<input type="radio"/>	<input type="radio"/>	<input type="radio"/>				
<input type="radio"/>	<input type="radio"/>	<input type="radio"/>				
<input type="radio"/>	<input type="radio"/>	<input type="radio"/>				
<input type="radio"/>			<input type="radio"/>			
<input type="radio"/>			<input type="radio"/>			
			<input type="radio"/>			
				<input type="radio"/>	<input type="radio"/>	
				<input type="radio"/>	<input type="radio"/>	
			<input type="radio"/>			
			<input type="radio"/>			
			<input type="radio"/>			
			<input type="radio"/>			
	<input type="radio"/>		<input type="radio"/>			
	<input type="radio"/>	<input type="radio"/>				
			<input type="radio"/>			
			<input type="radio"/>			
			<input type="radio"/>			
<input type="radio"/>	<input type="radio"/>		<input type="radio"/>			<input type="radio"/>



- <LENS> stands for “AF stop button” provided on super telephoto lenses equipped with Image Stabilizer.

C.Fn III-4: Retract lens on power off

You can set whether to retract gear-type STM lenses (such as EF40mm f/2.8 STM) automatically when the camera's power switch is set to <OFF>.

- 0: Enable
- 1: Disable



- With auto power off, the lens will not retract regardless of the setting.
- Before detaching the lens, make sure that it is retracted.



- When **[0:Enable]** is set, this function takes effect regardless of the lens's focus mode switch setting (AF or MF).

C.Fn III-5: Audio compression

Sets audio compression for movie recording. **[1:Disable]** allows higher audio quality than when audio is compressed, but file sizes are larger.

- 0: Enable
- 1: Disable



- Editing movie files recorded with **[1:Disable]** and then saving them with compression will also compress the audio.
- Audio is compressed even if **[1:Disable]** is selected when **[Movie rec. size]** is set to **FHD 29.97P (IPB)** (NTSC) or **FHD 25.00P (IPB)** (PAL).
- Audio for Basic Zone or video snapshots is compressed even when **[1:Disable]** is selected.

Fine Adjustment of AF Position (AF Microadjustment)

Fine adjustment of the point of focus is possible when autofocusing in viewfinder shooting.



- Normally, AF microadjustment is not required. Perform this adjustment only if necessary. Make sure to note that performing this adjustment may prevent accurate focusing from being achieved.

1: Adjust All by Same Amount

Set the adjustment amount manually by repeatedly making adjustments, shooting, and checking the results until the desired result is achieved. During AF, regardless of the lens used, the point of focus will always be shifted by the adjustment amount.

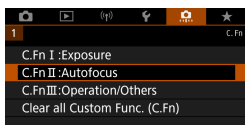

1 Select [C.Fn II:Autofocus].

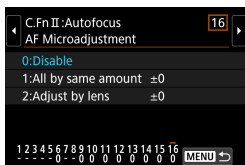

2 Select [16: AF Microadjustment].

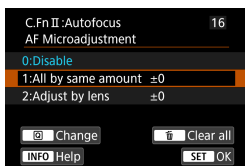

3 Select [1:All by same amount].

4 Press the <Q> button.

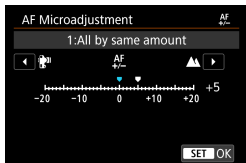

5 Make the adjustment.

- Setting it toward “-:⏪” will shift the point of focus in front of the standard point of focus.
- Setting it toward “+:⏩” will shift the point of focus to behind the standard point of focus.
- After making the adjustment, press $\langle \text{SET} \rangle$.
- Press $\langle \text{SET} \rangle$ again.

6 Check the result of the adjustment.

- Take a picture to check the results of adjustment.
- Repeat the adjustment as necessary.

- !**
- If [1:All by same amount] is selected, separate AF adjustment will not be possible for the wide-angle and telephoto ends of zoom lenses.

2: Adjust by Lens

You can make the adjustment for each lens and register the adjustment in the camera. You can register the adjustment for up to 40 lenses. When you autofocus with a lens whose adjustment is registered, the point of focus will always be shifted by the adjustment amount.

Set the adjustment amount manually by repeatedly making adjustments, shooting, and checking the results until the desired result is achieved. If you use a zoom lens, make the adjustment for the wide-angle (W) and telephoto (T) ends.

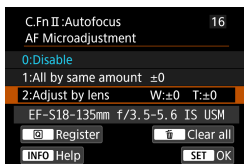

1 Select [2: Adjust by lens].

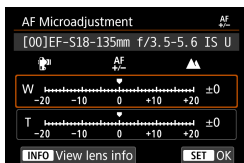

2 Press the <Q> button.

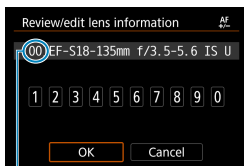

3 Check and change the lens information.

Displaying the Lens Information

- Press the <INFO> button to display the lens name and a 10-digit serial number. When the serial number is displayed, select **[OK]** and go to step 4.
- If the lens's serial number cannot be confirmed, "0000000000" will be displayed. In this case, enter the number by following the instructions on the next page.
- Regarding the asterisk "*" displayed in front of some lens serial numbers, see the next page.

(1) Registered number

(1)



Entering the Serial Number

- Select the digit to be entered, then press $\langle \text{SET} \rangle$ so $\langle \updownarrow \rangle$ is displayed.
- Enter the number, then press $\langle \text{SET} \rangle$.
- After entering all the digits, select **[OK]**.

Lens Serial Number

- In step 3, if “*” appears in front of the 10-digit lens serial number, you can register only one unit of the same lens model. Even if you enter the serial number, “*” will remain displayed.
- The serial number on the lens may differ from the serial number displayed on the screen in step 3. This is not a malfunction.
- If the lens serial number includes letters, enter only the numbers.
- If the lens serial number is eleven digits or longer, enter only the last ten digits.
- The location of the serial number varies depending on the lens.
- Certain lenses may not have a serial number inscribed. To register a lens that has no serial number inscribed, enter any serial number.



- If **[2: Adjust by lens]** is selected and an extender is used, the adjustment will be registered for the lens and extender combination.
- If 40 lenses have already been registered, a message will appear. After you select a lens whose registration is to be erased (overwritten), you can register another lens.

Single focal length lens

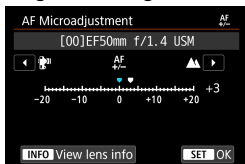

Zoom lens

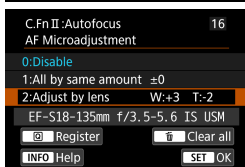
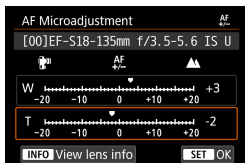

4 Make the adjustment.

- For a zoom lens, select the wide-angle (W) or telephoto (T) end. Pressing **<SET>** will turn off the orange frame and make the adjustment possible.
- Set the adjustment amount, then press **<SET>**.
- Setting it toward “-:▲” will shift the point of focus in front of the standard point of focus.
- Setting it toward “+:▲” will shift the point of focus to behind the standard point of focus.
- For a zoom lens, repeat this procedure and adjust it for the wide-angle (W) and telephoto (T) ends.
- After completing the adjustment, press the **<MENU>** button to return to the screen in step 1.

5 Check the result of the adjustment.

- Take a picture to check the adjustment result.
- Repeat the adjustment as necessary.



- When shooting with the intermediate range (focal length) of a zoom lens, the AF's point of focus is corrected automatically relative to the adjustments made for the wide-angle and telephoto ends. Even if only the wide-angle or telephoto end is adjusted, a correction will be made automatically for the intermediate range.

Clearing All AF Microadjustments

When **[Clear all]** appears at the bottom of the screen, pressing the **< [Clear] >** button will clear all the adjustments made for **[1:All by same amount]** and **[2:Adjust by lens]**.



Cautions for AF Microadjustment

- The AF's point of focus will vary slightly depending on the subject conditions, brightness, zoom position, and other shooting conditions. Therefore, even if you perform AF Microadjustment, focus may still not be achieved at the suitable position.
- The adjustment amount of one step varies depending on the maximum aperture of the lens. Keep adjusting, shooting, and checking the focus repeatedly to adjust the AF's point of focus.
- The adjustment will not be applied to AF in Live View shooting or movie recording.
- The adjustments will be retained even if you do **[Fn : Clear all Custom Func. (C.Fn)]** (581). However, the setting will be **[0:Disable]**.
- To check adjustment results, focus with One-Shot AF.



Notes for AF Microadjustment

- It is best to make the adjustment at the actual location where you will shoot. This will make the adjustment more precise.
- Using a tripod when making the adjustment is recommended.
- For making adjustments, shooting at the **[L]** image-recording quality is recommended.

Clearing Custom Function Settings

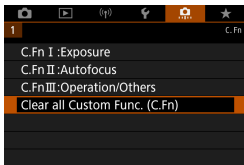

Selecting [**C.Fn III**]: **Clear all Custom Func. (C.Fn)**] clears all Custom Function settings. Note that [**Custom Controls**] settings are not cleared.

Tab Menus: My Menu

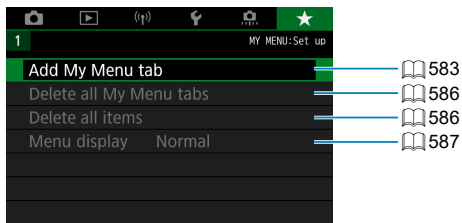



Registering My Menu

Under My Menu tab, you can register menu items and Custom Functions whose settings you change frequently.

Creating and Adding My Menu Tab

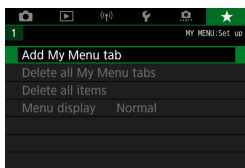

1 Select [Add My Menu tab].

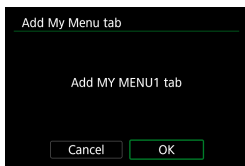

2 Select [OK].

- You can create up to five My Menu tabs by repeating steps 1 and 2.

Registering Menu Items under the My Menu Tab(s)

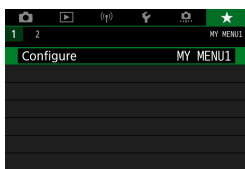

1 Select [MY MENU*: Configure].

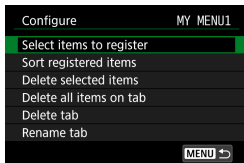

2 Select [Select items to register].

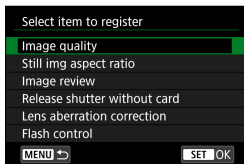

3 Register the desired items.

- Select the item to be set, then press $\langle \text{SET} \rangle$.
- Select **[OK]** on the confirmation dialog.
- You can register up to six items.
- To return to the screen in step 2, press the $\langle \text{MENU} \rangle$ button.

My Menu Tab Settings

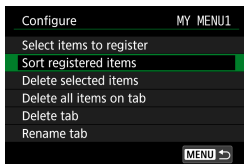

You can sort and delete items under the menu tab, and rename or delete the menu tab.

● Sort registered items

You can change the order of the registered items in My Menu. Select **[Sort registered items]**, select an item to rearrange, then press $\langle \text{SET} \rangle$. With $\langle \blacklozenge \rangle$ displayed, use the $\langle \text{DIAL} \rangle$ dial to move the item, then press $\langle \text{SET} \rangle$.

● Delete selected items/Delete all items on tab

You can delete any of the registered items. **[Delete selected items]** deletes one item at a time, and **[Delete all items on tab]** deletes all the registered items under the tab.

● Delete tab

You can delete the current My Menu tab. Select [**Delete tab**] to delete the [**MY MENU***] tab.

● Rename tab

You can rename the My Menu tab from [**MY MENU***].

1 Select [**Rename tab**].

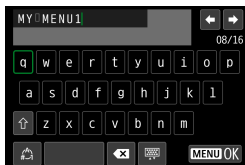

2 Enter text.

- Select [**✕**] or press the <🗑️> button to delete any unneeded characters.
- Use <⬅️> <➡️> to select a character, then press <ⓈET>.
- By selecting [**🔊**], you can change the input mode.

3 Confirm input.

- Press the <MENU> button, then press [**OK**].

Deleting all My Menu tabs/Deleting all items

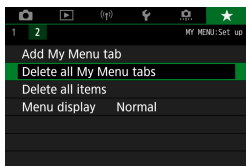

You can delete all the created My Menu tabs or My Menu items registered under them.

● Delete all My Menu tabs

You can delete all My Menu tabs you created. When you select **[Delete all My Menu tabs]**, all the tabs from **[MY MENU1]** to **[MY MENU5]** will be deleted and the **[★]** tab will revert to its default.

● Delete all items

You can delete all the items registered under the **[MY MENU1]** to **[MY MENU5]** tabs. The tab(s) will remain. When **[Delete all items]** is selected, all the items registered under all the created tabs will be deleted.

- If you perform **[Delete tab]** or **[Delete all My Menu tabs]**, tab names renamed with **[Rename tab]** will also be deleted.

Menu Display Settings

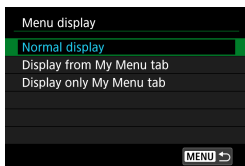

You can select **[Menu display]** to set the menu screen that is to appear first when you press the <MENU> button.

- **Normal display**

Displays the last displayed menu screen.

- **Display from My Menu tab**

Displays with the [★] tab selected.

- **Display only My Menu tab**

Only the [★] tab is displayed. (The [📷], [▶], [⏪], [🔍], and [⋮] tabs will not be displayed.)



Reference

This chapter provides reference information on camera features.

Software

Downloading and Installing the EOS Software or Other Dedicated Software

Always install the latest version of the software.

Update any previous versions that are installed by overwriting them with the latest version.

- Do not connect the camera to a computer before you install the software. The software will not be installed correctly.
- The software cannot be installed unless the computer is connected to the Internet.
- Previous versions cannot display images from this camera correctly. Also, processing RAW images from this camera is not possible.

1 Download the software.

- Connect to the Internet from a computer and access the following Canon website.

www.canon.com/icpd

- Enter the serial number on the bottom of the camera, then download the software.
- Decompress it on the computer.
 - **For Windows**
Click the displayed installer file to start the installer.
 - **For Macintosh**
A dmg file will be created and displayed. Follow the steps below to startup the installer.

- (1) Double-click the dmg file.
 - ▶ A drive icon and installer file will appear on the desktop.
If the installer file does not appear, double-click the drive icon to display it.
- (2) Double-click the installer file.
 - ▶ The installer starts.

2 Follow the on-screen instructions to install the software.

Downloading the Software Instruction Manuals

Software Instruction Manuals (PDF files) can be downloaded from the Canon website to your computer.

- **Software Instruction Manual Download Site**
www.canon.com/icpd



- **To view the Instruction Manuals (PDF files), an Adobe PDF viewing software such as Adobe Acrobat Reader DC (most recent version recommended) is required.**
- Adobe Acrobat Reader DC can be downloaded for free from the Internet.
- Double-click the downloaded Instruction Manual (PDF file) to open it.
- To learn how to use PDF viewing software, refer to the software's Help section.

Importing Images to a Computer

You can use EOS software to import images from the camera to a computer. There are three ways to do this.

Connecting to a Computer via an Interface Cable (sold separately)

1 Install the software (📖 590).

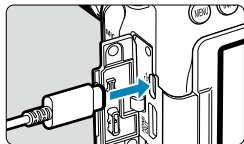

2 Connect the camera to the computer with Interface Cable IFC-600PCU (computer end: USB Type-A).

- Insert the plug into the camera's digital terminal.
- Connect the cord's plug to the computer's USB terminal.

3 Use EOS Utility to import the images.

- Refer to the EOS Utility Instruction Manual.

- !**
- With Wi-Fi connection established, the camera cannot communicate with the computer even if they are connected with an interface cable.

Card Reader

You can use a card reader to import images to a computer.

1 Install the software (📖 590).

2 Insert the card into the card reader.

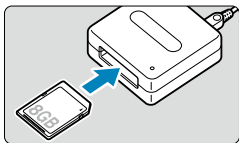

3 Use Digital Photo Professional to import the images.

- Refer to the Digital Photo Professional Instruction Manual.



- When downloading images from the camera to a computer with a card reader without using EOS software, copy the DCIM folder on the card to the computer.

Connecting to a Computer via Wi-Fi

You can connect the camera to the computer via Wi-Fi and import images to the computer (📖 426).

Battery Grip BG-E14

BG-E14 is a battery grip you can use with two LP-E6N/LP-E6 battery packs, or with AA/R6 batteries. It provides controls to use in vertical shooting, such as a shutter button and Main dial. For instructions on attachment and use, refer to the BG-E14 Instruction Manual.

Household Power Outlet Accessory

You can power the camera with a household power outlet by using the DC Coupler DR-E6 and AC Adapter AC-E6N (each sold separately). For instructions on attachment and use, refer to the DR-E6 and AC-E6N instruction manuals.



- Do not use an AC adapter other than the AC-E6N.
- While the camera's power switch is on, do not connect or disconnect the power cord or connector or do not disconnect the DC coupler.
- After using the camera, unplug the power plug from the power outlet.



- AC Adapter Kit ACK-E6 can also be used.

Troubleshooting Guide

If a problem occurs with the camera, first refer to this Troubleshooting Guide. If this Troubleshooting Guide does not resolve the problem, contact your dealer or nearest Canon Service Center.

Power-Related Problems

The battery does not recharge.

- If the battery's remaining capacity (📖 524) is 94% or higher, the battery will not be recharged.
- Do not use any battery other than genuine Canon Battery Pack LP-E6N/LP-E6.

The charger's lamp blinks at high speed.

- If (1) the battery charger or battery has a problem or (2) communication with the battery failed (with a non-Canon battery pack), the protection circuit will stop charging, and the charge lamp will blink in orange at a constant high speed. In the case of (1), unplug the charger's power plug from the power outlet. Detach and reattach the battery to the charger. Wait a few minutes, then reconnect the power plug to the power outlet. If the problem persists, contact your dealer or nearest Canon Service Center.

The charger's lamp does not blink.

- If the internal temperature of the battery attached to the charger is high, the charger will not charge the battery for safety reasons (lamp off). During charging, if the battery's temperature becomes high for any reason, charging will stop automatically (lamp blinks). When the battery temperature goes down, charging will resume automatically.

The camera is not activated even when the power switch is set to <ON>.

- Make sure the battery compartment cover is closed (📖 47).
- Make sure the battery is installed properly in the camera (📖 47).
- Charge the battery (📖 44).
- Make sure the card slot cover is closed (📖 48).

The access lamp still lights or blinks even when the power switch is set to <OFF>.

- If the power is turned off while an image is being recorded to the card, the access lamp will remain on or continue to blink for a few seconds. When the image recording is complete, the power will turn off automatically.

[Does this battery/do these batteries display the Canon logo?] is displayed.

- Do not use any battery other than genuine Canon Battery Pack LP-E6N/LP-E6.
- Remove and install the battery again (📖 47).
- If the electrical contacts are dirty, use a soft cloth to clean them.

The battery becomes exhausted quickly.

- Use a fully charged battery (📖 44).
- The battery performance may have degraded. See [🔧: Battery info.] to check the battery's recharge performance level (📖 524). If the battery performance is poor, replace the battery with a new one.
- The number of possible shots will decrease with any of the following operations:
 - Pressing the shutter button halfway for a prolonged period.
 - Activating the AF frequently without taking a picture.
 - Using the lens's Image Stabilizer.
 - Using the screen frequently.
 - Continuing Live View shooting or movie recording for a prolonged period.
 - Using the wireless communication functions.

The camera turns off by itself.

- Auto power off is in effect. To deactivate auto power off, set [🔧: Auto power off] to [Disable] (📖 513).
- Even if [🔧: Auto power off] is set to [Disable], the screen will still turn off after the camera is left idle for approx. 30 min. (The camera's power does not turn off.)

The camera does not work with AA/R6 batteries in the battery grip.

- Reinstalling the battery magazine and restarting the camera may restore camera operation.

Shooting-Related Problems

The lens cannot be attached.

- The camera cannot be used with RF or EF-M lenses (📖 54).



The viewfinder is dark.

- Install a recharged battery in the camera (📖 44).

No images can be shot or recorded.

- Make sure the card is properly inserted (📖 48).
- Slide the card's write-protect switch to the Write/Erase setting (📖 48).
- If the card is full, replace the card or delete unnecessary images to make space (📖 48, 📖 350).
- You cannot take a picture when focusing with One-Shot AF and the focus indicator <●> in the viewfinder is blinking or when the AF point is orange during Live View/movie shooting. Press the shutter button halfway again to refocus automatically, or focus manually (📖 57, 📖 147).

The card cannot be used.

- If a card error message is displayed, see  50 or  613.

An error message is displayed when the card is inserted in another camera.

- Since SDXC cards are formatted in exFAT, if you format a card with this camera and then insert it into another camera, an error may be displayed and it may not be possible to use the card.

I have to press the shutter button twice to take a picture.

- Set [: Mirror lockup] to [Disable].



The image is out of focus or blurred.

- Set the lens's focus mode switch to <AF> ( 54).
- Press the shutter button gently to prevent camera shake ( 56,  57).
- With a lens equipped with an Image Stabilizer, set the IS switch to <ON>.
- In low light, the shutter speed may become slow. Use a faster shutter speed ( 112), set a higher ISO speed ( 213), use flash ( 164,  179), or use a tripod.
- See “Minimizing Blurred Photos” on  78.

There are fewer AF points or the Area AF frame shape is different.

- Depending on the lens used, the number of usable AF points, AF point patterns, Area AF frame shape, etc. vary.



The AF point is blinking or two AF points are displayed.

- Regarding the AF points lighting up or blinking when you press the  or  button, see  133.



The AF points do not light up in red.

- The AF points light up in red when you shoot under low light or when focus is achieved on a dark subject.
- In the **<P>**, **<Tv>**, **<Av>**, **<M>**, or **** mode, you can set whether to have the AF points light up in red for when focus is achieved ( 569).

I cannot lock the focus and recompose the shot.

- Set the AF operation to One-Shot AF. Focus lock is not possible in the AI Servo AF/Servo AF mode or when servo takes effect in AI Focus AF mode ( 80,  125).

The continuous shooting speed is slow.

- The continuous shooting speed for high-speed continuous shooting may be lower, depending on conditions such as these: temperature, battery level, flicker reduction, shutter speed, aperture, subject conditions, brightness, AF operation, type of lens, live view shooting, use of flash, and shooting settings, etc. For details, see  150 or  152.



The maximum burst during continuous shooting is lower.

- If you shoot a subject that has fine detail such as a field of grass, the file size will be larger, and the actual maximum burst may be lower than the number listed on  615.

Even after I change the card, the maximum burst displayed for continuous shooting does not change.

- The maximum burst displayed does not change when you switch cards, even if you switch to a high-speed card. The maximum burst shown in the table on  615 is based on Canon's testing card. (The faster the card's writing speed, the higher the actual maximum burst will be.) For this reason, the maximum burst displayed may differ from the actual maximum burst.

Even if I set a decreased exposure compensation, the image comes out bright.

- Set [: **Auto Lighting Optimizer**] to [**Disable**] ( 218). When [**Low**], [**Standard**], or [**High**] is set, even if you set a decreased exposure compensation or flash exposure compensation, the image may come out bright.

I cannot set the exposure compensation when both manual exposure and ISO Auto are set.

- See  118 to set the exposure compensation.

Not all the lens aberration correction options are displayed.

- Although [**Chromatic aberr corr**] and [**Diffraction correction**] are not displayed when [**Digital Lens Optimizer**] is set to [**Enable**], both functions are applied in shooting, as when set to [**Enable**].
- During movie recording, [**Digital Lens Optimizer**], [**Diffraction correction**], or [**Distortion correction**] will not be displayed.

The built-in flash does not fire.

- Shooting with the flash may be temporarily disabled to protect the flash head if the built-in flash is used repeatedly over a short period.

The external Speedlite does not fire.

- Make sure the external Speedlite is securely attached to the camera.
- When using non-Canon flash units in Live View shooting, set [: **Shutter mode**] to an option other than [**Electronic**] (📖 243).

The external Speedlite always fires at full output.

- If you use a flash unit other than an EL/EX series Speedlite, the flash will always fire at full output (📖 179).
- When [**Flash metering mode**] in the external flash Custom Function settings is set to [**TTL flash metering**] (autoflash), the flash always fires at full output (📖 179).

External flash exposure compensation cannot be set.

- If external flash exposure compensation was already set on the Speedlite, it cannot be set on the camera. When the external Speedlite's flash exposure compensation is canceled (set to 0), flash exposure compensation can be set with the camera.

Remote control shooting is not possible.

- When taking still photos, set the drive mode to < > or < 2 > (📖 151). When recording movies, set [: **Remote control**] to [**Enable**] (📖 322).
- Check the position of the remote control's release timing switch.
- If you are using Wireless Remote Control BR-E1, see 📖 156.
- Infrared remote controllers such as the RC-6 cannot be used for remote control shooting when the camera is paired via Bluetooth with a smartphone or wireless remote control. Set [**Bluetooth settings**] to [**Disable**].
- To use a remote control for time-lapse movie recording, see 📖 311.

Enabling Live View Shooting

- Set [: Live View shoot.] to [Enable].

The shutter makes two release sounds during Live View shooting.

- If you use flash with Live View shooting, the shutter will make two release sounds each time you shoot.

During Live View shooting, a white or red icon is displayed.

- It indicates that the camera's internal temperature is high. Image quality of still photos may be worse when a white icon is displayed. If the red icon is displayed, it indicates that the Live View shooting will soon stop automatically (269).

Expanded ISO speeds cannot be selected for still photo shooting.

- Check the [ISO speed range] setting under [: ISO speed settings].
- Expanded ISO speeds are not available when [: Highlight tone priority] is set to [Enable] or [Enhanced].

During movie recording, the red icon is displayed.

- It indicates that the camera's internal temperature is high. If the red icon is displayed, it indicates that the movie recording will soon stop automatically (326).

During movie recording, [] is displayed.

- It indicates that the camera's internal temperature is high. Movie recording is not possible as long as [] is displayed. If [] appears during movie recording, the camera will turn off automatically in approx. 3 min. (326).

Movie recording stops by itself.

- If the card's writing speed is slow, movie recording may stop automatically. For cards that can record movies, see  617. To find out the card's writing speed, refer to the card manufacturer's website, etc.
- If you shoot a movie for 29 min. 59 sec., the movie recording will stop automatically.



The ISO speed cannot be set for movie recording.

- In shooting modes other than <M>, the ISO speed is set automatically. In the <M> mode, you can manually set the ISO speed ( 280).

The manually set ISO speed changes when switching to movie recording.

- For viewfinder shooting and Live View shooting, the ISO speed will be set according to [ISO speed range] under [:  ISO speed settings] ( 215). For movie recording, the ISO speed will be set according to [ISO speed range] under [:  ISO speed settings] ( 322).

Expanded ISO speeds cannot be selected for movie recording.

- Check the [ISO speed range] setting under [:  ISO speed settings].
- Expanded ISO speeds are not available when [: Highlight tone priority] is set to [Enable].

The exposure changes during movie recording.

- If you change the shutter speed or aperture during movie recording, the changes in the exposure may be recorded.
- Shooting a few test movies is recommended if you intend to perform zooming during movie recording. Zooming during movie recording may result in recording of changes in exposure or mechanical sound of the lens, or images may be out of focus.

The image flickers or horizontal stripes appear during movie recording.

- Flickering, horizontal stripes (noise), or irregular exposures can be caused by fluorescent lighting, LED lighting, or other light sources during movie recording. Also, changes in the exposure (brightness) or color tone may be recorded. In the <M> mode, a slow shutter speed may reduce the problem. The problem may be more noticeable in time-lapse movie recording.

The subject looks distorted during movie recording.

- If you move the camera to the left or right (panning) or shoot a moving subject, the image may look distorted.

I cannot take still photos during movie recording.

- Still photos cannot be taken during movie recording. To take still photos, stop the movie recording and perform viewfinder shooting or Live View shooting.

Problems with Wireless Features

Cannot pair with a smartphone.

- Use a smartphone compliant with Bluetooth Specification Version 4.1 or later.
- Turn on Bluetooth from the smartphone settings screen.
- Pairing with the camera is not possible from the smartphone's Bluetooth settings screen. Install the dedicated app Camera Connect (free of charge) on the smartphone (📖 399).
- A previously paired smartphone cannot be paired with the camera again if the camera's registration is retained on the smartphone. In this case, remove the camera's registration retained in the Bluetooth settings on the smartphone and try pairing again (📖 406).

Wi-Fi function cannot be set.

- If the camera is connected to a computer or another device with an interface cable, Wi-Fi functions cannot be set. Disconnect the interface cable before setting any functions (📖 396).

A device connected with an interface cable cannot be used.

- Other devices, such as computers, cannot be used with the camera by connecting them with an interface cable while the camera is connected to devices via Wi-Fi. Terminate the Wi-Fi connection before connecting the interface cable.





Operations such as shooting and playback are not possible.

- With a Wi-Fi connection established, operations such as shooting and playback may not be possible. Terminate the Wi-Fi connection, then perform the operation.

Cannot reconnect to a smartphone.

- Even with a combination of the same camera and smartphone, if you have changed the settings or selected a different setting, reconnection may not be established even after selecting the same SSID. In this case, delete the camera connection settings from the Wi-Fi settings on the smartphone and set up a connection again.
- A connection may not be established if Camera Connect is running when you reconfigure connection settings. In this case, quit Camera Connect for a moment and then restart it.

Operation Problems



I cannot change the setting with , , , , or .

- Set the <LOCK> switch downward (lock release) (📖 60).
- Check the [: Multi function lock] setting (📖 545).

Touch operation is not possible.

- Make sure [: Touch control] is set to [Standard] or [Sensitive] (📖 521).

A camera button or dial does not work as expected.

- Check these settings: [: C.Fn II-7: Select AF area selec. mode], [: C.Fn II-9: AF area selection method], and [: Custom Controls] (📖 563, 📖 564, 📖 571).

Display Problems

The menu screen shows fewer tabs and items.

- Certain tabs and options do not appear in Basic Zone or for Live View shooting and movie recording.

The display starts with [★] My Menu, or the [★] tab alone is displayed.

- [Menu display] on the [★] tab is set to [Display from My Menu tab] or [Display only My Menu tab]. Set [Normal display] (📖 587).

The file name's first character is an underscore (“_”).

- Set [: Color space] to [sRGB]. If [Adobe RGB] is set, the first character will be an underscore (📖 229).

The file name starts with “MVI_”.

- It is a movie file (📖 507).

The file numbering does not start from 0001.

- If the card already contains recorded images, the image number may not start from 0001 (📖 507).

The shooting date and time displayed are incorrect.

- Make sure the correct date and time are set (📖 516).
- Check the time zone and daylight saving time (📖 516, 📖 517).

The date and time are not in the image.

- The shooting date and time do not appear in the image. The date and time are recorded in the image data as shooting information. When printing, you can imprint the date and time in the picture, using the date and time recorded in the shooting information (📖 354).

[###] is displayed.

- If the number of images recorded on the card exceeds the number the camera can display, [###] will be displayed.

In the viewfinder, the AF point display speed is slow.

- In low temperatures, the display speed of the AF points may become slower due to the AF point display device's (liquid crystal) characteristics. The display speed will return to normal at room temperature.

The screen does not display a clear image.

- If the screen is dirty, use a soft cloth to clean it.
- The screen display may seem slightly slow in low temperatures or may look black in high temperatures. It will return to normal at room temperature.

Playback Problems

Part of the image blinks in black.

- [▶]: **Highlight alert** is set to **[Enable]** (📖 391).

A red box is displayed on the image.

- [▶]: **AF point disp.** is set to **[Enable]** (📖 392).

During image playback, the AF points are not displayed.

- The AF points are not displayed when the following types of images are played back:
 - Images taken in the <SCN: 📷 🌞> modes.
 - Images taken in the HDR mode.
 - Images taken in the <🌙: 📷^{HDR} 📷^{HDR} 📷^{HDR} 📷^{HDR}> modes.
 - Images taken with Multi Shot Noise Reduction applied.
 - Cropped images.

The image cannot be erased.

- If the image is protected, it cannot be erased (📖 346).

Still photos and movies cannot be played back.

- The camera may not be able to play back images taken with another camera.
- Movies edited with a computer cannot be played back with the camera.

Only few images can be played back.

- The images have been filtered for playback with [▶]: **Set image search conditions** (📖 385). Clear the image search conditions.

Operation sound and mechanical sound can be heard during movie playback.

- If you operate the camera's dials or lens during movie recording, the operation sound will also be recorded. Using the Directional Stereo Microphone DM-E1 (sold separately) is recommended (📖 296).

The movie appears to freeze momentarily.

- If there is a drastic change in the exposure level during autoexposure movie recording, the recording will stop momentarily until the brightness stabilizes. In such a case, shoot in the <M> mode (📖 279).



No picture appears on the television.

- Make sure [**📺: Video system**] is set to [**For NTSC**] or [**For PAL**] correctly for the video system of your television.
- Make sure the HDMI cable's plug is inserted all the way in (📖 344).

There are multiple movie files for a single movie recording.

- If the movie file size reaches 4 GB, another movie file will be created automatically (📖 293). However, if you use an SDXC card formatted with the camera, you can record a movie in a single file even if it exceeds 4 GB.

My card reader does not recognize the card.

- Depending on the card reader used and the computer's operating system, SDXC cards may not be correctly recognized. In this case, either connect the camera to a computer with an interface cable (sold separately) and use EOS Utility (EOS software,  590) or connect the camera to a computer via Wi-Fi ( 426) to import the images on the camera.



The image cannot be resized.

- With this camera, you cannot resize JPEG **S2** and RAW images ( 379).

The image cannot be cropped.



- With this camera, you cannot crop RAW images ( 377).

Dots of light appear on the image.



- White, red, or blue dots of light may appear in captured images if the sensor is affected by cosmic rays or similar factors. Their appearance may be reduced by performing [**Clean now** ] under [**☛: Sensor cleaning**] ( 528).

Sensor Cleaning Problems

The shutter makes a sound during sensor cleaning.

- Under [**Y**: Sensor cleaning], when you select [**Clean now** ], the shutter will make a mechanical sound during the cleaning, but no picture will be recorded to the card ( 528).

Automatic sensor cleaning does not work.

- If you repeatedly turn the power switch <ON> and <OFF> within a short time period, the < > icon may not be displayed ( 52).

Computer Connection Problems

I cannot import images to a computer.

- Install EOS Utility (EOS software) in the computer ( 590).
- If the camera is already connected via Wi-Fi, it cannot communicate with any computer connected with an interface cable (sold separately).

Communication between the connected camera and computer does not work.

- When using EOS Utility (EOS software), set [**📷**: Time-lapse movie] to [**Disable**] ( 301).

Error Codes

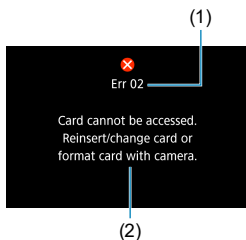

If there is a problem with the camera, an error message will appear. Follow the on-screen instructions. If the problem persists, write down the error code (Errxx) and contact a Customer Support Help Desk.

- (1) Error number
- (2) Cause and countermeasures

Performance Data

Still Photo Shooting

● Number of Possible Shots

(Approx. number of shots)

Temperature		Room Temperature (23°C / 73°F)	Low Temperature (0°C / 32°F)
No flash	In viewfinder shooting	1860	1850
	In Live View shooting	510	500
Flash output: 50%	In viewfinder shooting	1300	1200
	In Live View shooting	450	440

- Using a fully charged Battery Pack LP-E6N
- Based on CIPA (Camera & Imaging Products Association) testing standards
- Estimated shots with Battery Grip BG-E14 (sold separately):
Using two LP-E6N battery packs: approx. twice as many shots as the camera alone
Using AA/LR6 alkaline batteries (at a room temperature of 23°C/73°F): in viewfinder shooting, approx. 210 shots without flash or 200 shots at 50% flash output, and in Live View shooting, approx. 50 shots without flash or 50 shots at 50% flash output.

● ISO Auto Range

Shooting Mode	ISO Speed	
	No Flash	With Flash
P/Tv/Av/M	ISO 100–25600*	ISO 100–1600*
B	ISO 400*	ISO 400*

* The actual ISO speed range depends on the **[Minimum]** and **[Maximum]** set with **[Auto range]**.

- In Basic Zone modes, ISO speed is set automatically.

● Guide to Image Quality Settings

(Approx.)

Image Quality	Pixels Recorded	File Size (MB)	Possible Shots	Maximum Burst	
				Standard	High Speed
JPEG					
L	32M	11.1	2720	57	58
L		5.6	5380	57	58
M	15M	5.8	5190	55	55
M		3.0	9860	57	56
S1	8.1M	3.6	8390	57	57
S1		2.0	14600	57	57
S2	3.8M	1.6	18390	57	57
RAW					
RAW	32M	35.6	850	24	25
CRAW	32M	20.4	1490	39	39
RAW+JPEG					
RAW	32M	35.6	650	23	24
L	32M	11.1			
CRAW	32M	20.4	960	37	36
L	32M	11.1			

- The number of possible shots is based on Canon's testing standards and an 32 GB card.
- Maximum burst measured under conditions and with an SD card conforming to Canon testing standards (32 GB standard/UHS-II card, High-speed continuous shooting, 3:2 aspect ratio, ISO 100, Standard Picture Style).
- **The file size, number of possible shots, and maximum burst will vary depending on the subject, card brand, still image aspect ratio, ISO speed, Picture Style, Custom Functions, and other settings.**



- Even if you use a high-speed SD card, maximum burst indicator will not change. The maximum burst in the table will apply instead.

● Pixel Count at Specific Aspect Ratios

(Approx. pixels)

Image Quality	3:2	4:3
RAW / CRAW	6960 × 4640 (32.3 megapixels)	6960 × 4640 (32.3 megapixels)
L	6960 × 4640 (32.3 megapixels)	6160 × 4640 (28.6 megapixels)*
M	4800 × 3200 (15.4 megapixels)	4256 × 3200 (13.6 megapixels)*
S1	3472 × 2320 (8.1 megapixels)*	3072 × 2320 (7.1 megapixels)*
S2	2400 × 1600 (3.8 megapixels)	2112 × 1600 (3.4 megapixels)*

Image Quality	16:9	1:1
RAW / CRAW	6960 × 4640 (32.3 megapixels)	6960 × 4640 (32.3 megapixels)
L	6960 × 3904 (27.2 megapixels)*	4640 × 4640 (21.5 megapixels)
M	4800 × 2688 (12.9 megapixels)*	3200 × 3200 (10.2 megapixels)
S1	3472 × 1952 (6.8 megapixels)*	2320 × 2320 (5.4 megapixels)
S2	2400 × 1344 (3.2 megapixels)*	1600 × 1600 (2.6 megapixels)



- The actual aspect ratio of images in the sizes marked with an asterisk "*" will differ from the aspect ratio indicated.
- The image area displayed for the asterisked "*" aspect ratio may be slightly different from the actual image area. Check the captured images on the LCD monitor during shooting.
- For details on JPEG file sizes, see the values on 615. Under equivalent shooting conditions, file sizes will be smaller than when **[📷: Still img aspect ratio]** is set to **[3:2]**.

Movie Recording

• Cards that Can Record Movies

Movie Recording Size			SD Card
4K	29.97P 25.00P 23.98P	IPB	UHS-I, UHS Speed Class 3 or higher
FHD	119.9P 100.0P	IPB	
	59.94P 50.00P	IPB	SD Speed Class 10 or higher
	29.97P 25.00P 23.98P	IPB	SD Speed Class 4 or higher
	HDR movie		
	29.97P 25.00P	IPB	
FHD	59.94P 50.00P	IPB	
4K time-lapse movie			Reading speed of 40 Mbps or faster
Full HD time-lapse movie			Reading speed of 20 Mbps or faster

- When Movie digital IS are disabled.

● Total Movie Recording Time and File Size Per Minute

(Approx.)

Movie Recording Size				Total Possible Recording Time on Card			File Size		
				8 GB	32 GB	128 GB			
4K	29.97P	25.00P	23.98P	IPB	8 min.	35 min.	2 hr. 21 min.	860 MB/min.	
	119.9P	100.0P			8 min.	35 min.	2 hr. 22 min.	858 MB/min.	
FHD	59.94P	50.00P		IPB	17 min.	1 hr. 10 min.	4 hr. 43 min.	431 MB/min.	
	29.97P	25.00P	23.98P		35 min.	2 hr. 20 min.	9 hr. 23 min.	216 MB/min.	
	HDR movie								
	29.97P	25.00P			IPB	1 hr. 26 min.	5 hr. 47 min.	23 hr. 11 min.	87 MB/min.
HD	59.94P	50.00P		IPB	40 min.	2 hr. 42 min.	10 hr. 49 min.	187 MB/min.	

- When Movie digital IS are disabled.



- An increase of the camera's internal temperature may cause movie recording to stop before the total recording time shown in the table (📖 326).

● Total Possible Time for Movie Recording

(Approx.)

Temperature	Room Temperature (23°C / 73°F)	Low Temperature (0°C / 32°F)
Possible recording time	2 hr. 40 min.	2 hr. 30 min.

- With a fully charged Battery Pack LP-E6N.
- With [📷: Movie rec. size] set to 4K or FHD and [📷: Movie Servo AF] set to [Enable].

● Total Possible Time for Time-lapse Movie Recording

(Approx.)

Time-lapse Movie Recording		Room Temperature (23°C / 73°F)	Low Temperature (0°C / 32°F)
Interval	Screen Auto Off		
2 sec.	Disable	5 hr. 10 min.	5 hr. 10 min.
	Enable	7 hr. 30 min.	7 hr. 30 min.
10 sec.	Disable	4 hr. 10 min.	4 hr. 10 min.
	Enable	8 hr. 40 min.	8 hr. 40 min.

- With a fully charged Battery Pack LP-E6N.
- The possible movie recording time varies depending on the shooting conditions.

ISO Speed in Movie Recording

In [i] Mode

- The ISO speed will be set automatically within ISO 100–12800.
- Under [📷: i ISO speed settings], setting [Max for Auto] to [H (25600)] (📖 322) expands the maximum limit of the automatic ISO speed setting range to H (equivalent to ISO 25600).

In [iM] Mode

- With ISO speed set to [AUTO], the speed is automatically set in a range of ISO 100–12800.
- When ISO Auto is set, under [📷: iM ISO speed settings], setting [Max for Auto] to [H (25600)] (📖 322) expands the maximum limit of the automatic ISO speed setting range to H (equivalent to ISO 25600).
- ISO speed can be set manually in a range of ISO 100–12800. Note that under [📷: iM ISO speed settings], setting [ISO speed range] to [H (25600)] (📖 322) expands the maximum speed in the manual ISO speed setting range to H (equivalent to ISO 25600).

- [H (25600)] is not available when recording 4K movies, 4K time-lapse movies, or Full HD time-lapse movies.

Image Playback

● Resize Options by Original Image Quality

Original Image Quality	Available Resize Settings		
	M	S1	S2
L*	<input type="radio"/>	<input type="radio"/>	<input type="radio"/>
M	<input type="radio"/>	<input type="radio"/>	<input type="radio"/>
S1	<input type="radio"/>	<input type="radio"/>	<input type="radio"/>

● Size for Resized Images

(Approx. pixels)

Image Quality	3:2	4:3
M	15.4 megapixels (4800 × 3200)	—
S1	8.1 megapixels (3472 × 2320)	—
S2	3.8 megapixels (2400 × 1600)	3.4 megapixels (2112 × 1600)

Image Quality	16:9	1:1
M	12.9 megapixels (4800 × 2688)	10.2 megapixels (3200 × 3200)
S1	6.8 megapixels (3472 × 1952)	5.4 megapixels (2320 × 2320)
S2	3.2 megapixels (2400 × 1344)	2.6 megapixels (1600 × 1600)



- The actual aspect ratio of images in the sizes marked with an asterisk “*” will differ from the aspect ratio indicated.
- The image may be cropped slightly depending on the resizing conditions.

Information Display

Quick Control Screen (in Viewfinder Shooting)

Each time you press the <INFO> button, the information display will change.

- The display will show only the settings currently applied.

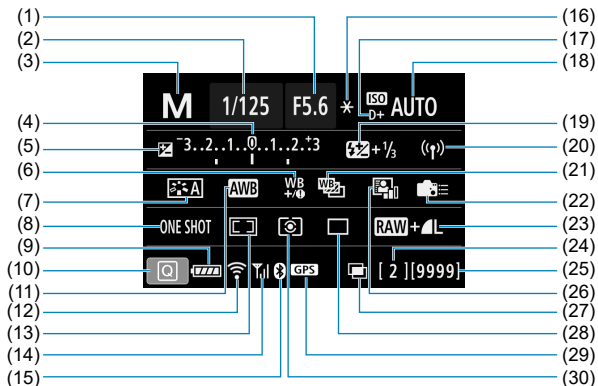

(1) Aperture value

(2) Shutter speed

(3) Shooting mode

(4) Exposure level indicator

(5) Exposure compensation

(6) White balance correction

(7) Picture Style

(8) AF operation

(9) Battery level

(10) Quick Control icon

(11) White balance

(12) Wi-Fi function

(13) AF area selection mode/
AF point selection

(14) Wireless signal strength

(15) Bluetooth function

(16) AE lock

(17) Highlight tone priority

(18) ISO speed

(19) Flash exposure compensation

(20) Wi-Fi/Bluetooth connection

(21) White balance bracketing

(22) Custom Controls

(23) Image quality

(24) Maximum burst/Number of
remaining multiple exposures

(25) Possible shots/Auto cleaning

(26) Auto Lighting Optimizer

(27) Multiple exposures/HDR/Multi
Shot Noise Reduction

(28) Drive mode

(29) GPS acquisition status

(30) Metering mode

Live View Shooting Screen

Each time you press the <INFO> button, the information display will change.

- The display will show only the settings currently applied.

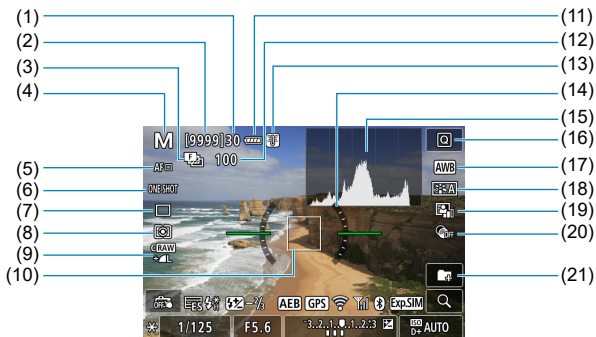

(1) Maximum burst	(11) Battery level
(2) Possible shots/Sec. until self-timer shoots	(12) No. of shots left for focus bracketing/multiple exposures/interval timer
(3) Focus bracketing/HDR/Multiple exposures/Multi Shot Noise Reduction/Bulb timer/Interval timer	(13) Temperature warning
(4) Shooting mode/Scene icon	(14) Electronic level
(5) AF method	(15) Histogram
(6) AF operation	(16) Quick Control button
(7) Drive mode	(17) White balance/White balance correction
(8) Metering mode	(18) Picture Style
(9) Image quality	(19) Auto Lighting Optimizer
(10) AF point (1-point AF)	(20) Creative filters
	(21) Create folder

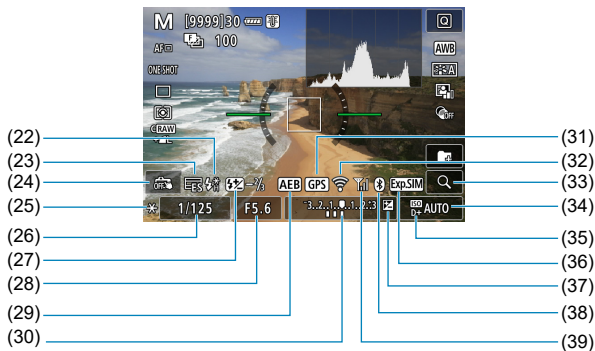

(22) Warning to use flash (blinking)/
Flash ready (on)/FE Lock/High-
speed sync

(23) Electronic Shutter

(24) Touch Shutter

(25) AE lock

(26) Shutter speed/Multi-function lock
warning

(27) Flash exposure compensation

(28) Aperture value

(29) AEB/FEB

(30) Exposure level indicator

(31) GPS acquisition status

(32) Wi-Fi function

(33) Magnify button

(34) ISO speed

(35) Highlight tone priority

(36) Exposure simulation

(37) Exposure compensation

(38) Bluetooth function

(39) Wi-Fi signal strength



- You can set what is displayed for when you press the <INFO> button (539).
- The electronic level is not displayed when the AF method is set to **[+Tracking]** or the camera is connected via HDMI to a television.
- Other icons may be displayed temporarily after setting adjustments.

Movie Recording Screen

Each time you press the <INFO> button, the information display will change.

- The display will show only the settings currently applied.

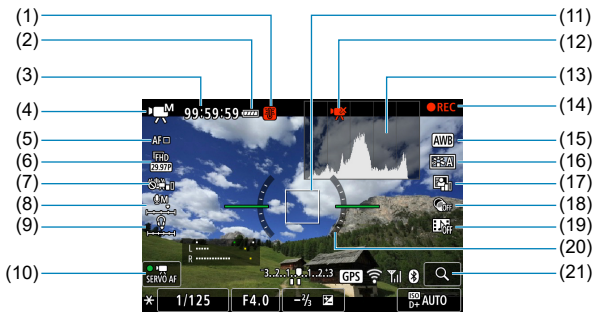

(1) Temperature warning

(2) Battery level

(3) Movie recording time available/
Elapsed recording time

(4) Movie recording mode/
Time-lapse movie/Scene icon

(5) AF method

(6) Movie recording size

(7) Movie digital IS

(8) Sound-recording level (manual)

(9) Headphone volume

(10) Movie Servo AF

(11) AF point (1-point AF)

(12) 4K movie cropping prohibited

(13) Histogram (for manual exposure)

(14) Movie recording in progress

(15) White balance/White balance
correction

(16) Picture Style

(17) Auto Lighting Optimizer

(18) Creative filters

(19) Video snapshot

(20) Electronic level

(21) Magnify button

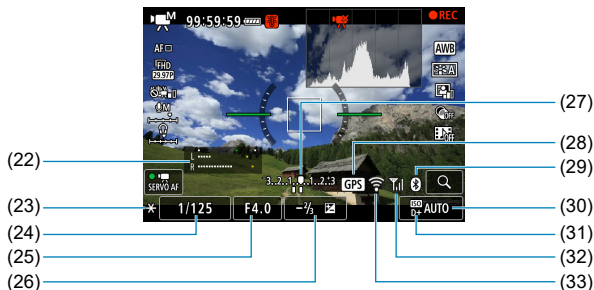

(22) Sound-recording level indicator (manual)

(23) AE lock

(24) Shutter speed

(25) Aperture value

(26) Exposure compensation

(27) Exposure level indicator

(28) GPS acquisition status

(29) Bluetooth function

(30) ISO speed

(31) Highlight tone priority

(32) Wi-Fi signal strength

(33) Wi-Fi function

- You can set what is displayed for when you press the <INFO> button (539).
- The electronic level is not displayed when the AF method is set to **[L+Tracking]** or the camera is connected via HDMI to a television.
- The electronic level, grid lines, or histogram cannot be displayed during movie recording. (The display will disappear when you start recording a movie.)
- When movie recording starts, the movie recording remaining time will change to the elapsed time.

- Other icons may be displayed temporarily after setting adjustments.

Scene Icons

In $\langle \text{A}^+ \rangle$ mode, in Live View shooting or when recording movies, the camera detects the type of scene and sets all settings automatically to suit the scene. The detected scene type is indicated on the upper left of the screen.

Subject Background	Portrait		Non-Portrait			Background Color
		In Motion* ¹	Nature/ Outdoor Scene	In Motion* ¹	Close* ²	
Bright						Gray
Backlit						
Blue Sky Included						Light blue
Backlit						
Sunset	* ³			* ³		Orange
Spotlight						Dark blue
Dark						
With Tripod* ¹	* ⁴ * ⁵	* ³	* ⁴ * ⁵	* ³		

*1: Not displayed during movie recording.

*2: Displayed when the attached lens has distance information. With an extension tube or close-up lens, the icon displayed may not match the actual scene.

*3: The icon of the scene selected from the detectable scenes will be displayed.



- For certain scenes or shooting conditions, the icon displayed may not match the actual scene.

- *4: Displayed when all the following conditions apply:
The shooting scene is dark, it is a night scene, and the camera is mounted on a tripod.
- *5: Displayed with any of the lenses below:
- EF-S18-55mm f/3.5-5.6 IS II
 - EF-S55-250mm f/4-5.6 IS II
 - EF300mm f/2.8L IS II USM
 - EF400mm f/2.8L IS II USM
 - EF500mm f/4L IS II USM
 - EF600mm f/4L IS II USM
 - Image Stabilizer lenses released in and after 2012.
- *4+*5: If the conditions in both *4 and *5 are met, the shutter speed will slow down.

Playback Screen

● Basic information display for still photos

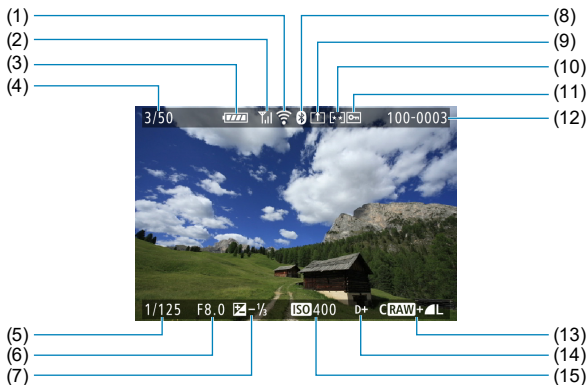

- | |
|--|
| (1) Wi-Fi function |
| (2) Wi-Fi signal strength |
| (3) Battery level |
| (4) Playback No./Total images/
Number of found images |
| (5) Shutter speed |
| (6) Aperture value |
| (7) Exposure compensation amount |

- | |
|---|
| (8) Bluetooth function |
| (9) Already sent to a computer/
smartphone |
| (10) Rating |
| (11) Image protection |
| (12) Folder number-File number |
| (13) Image quality/Edited image/
Cropping |
| (14) Highlight tone priority |
| (15) ISO speed |



- If the image was taken by another camera, certain shooting information may not be displayed.
- It may not be possible to play back images taken with this camera on other cameras.

● Detailed information display for still photos

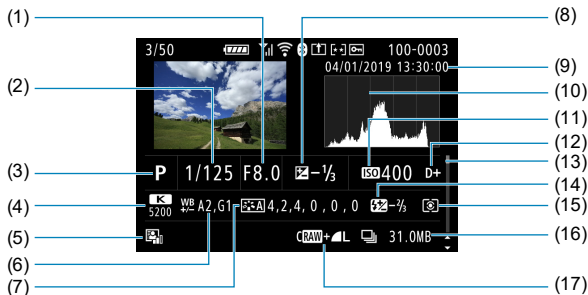

(1)	Aperture value
(2)	Shutter speed
(3)	Shooting mode/Multiple exposure
(4)	White balance
(5)	Auto Lighting Optimizer
(6)	White balance correction
(7)	Picture Style/Settings
(8)	Exposure compensation amount
(9)	Shooting date and time
(10)	Histogram (Brightness/RGB)

(11)	ISO speed
(12)	Highlight tone priority
(13)	Scroll bar
(14)	Flash exposure compensation/ Bounce/HDR shooting/Multi Shot Noise Reduction
(15)	Metering mode
(16)	File size
(17)	Image quality/Edited image/ Cropping

* When you shoot in RAW+JPEG image quality, the RAW image file size will be displayed.

* Lines indicating the image area will be displayed for images taken with the aspect ratio set (202) and with RAW or RAW+JPEG set for image quality.

* During flash photography without flash exposure compensation, <f> will be displayed.

* <f> will be displayed for images shot with bounce flash photography.

* An icon for the effect (252) and the dynamic range adjustment amount will be displayed for images shot with HDR shooting.

* <M> will be displayed for images shot with multiple-exposure shooting.

* <NR> will be displayed for images shot with Multi Shot Noise Reduction.

* <C> will be displayed for images created and saved after performing RAW image processing, resizing, cropping, or Creative Assist.

* <C> will be displayed for images cropped and then saved.

● Detailed information display for movies

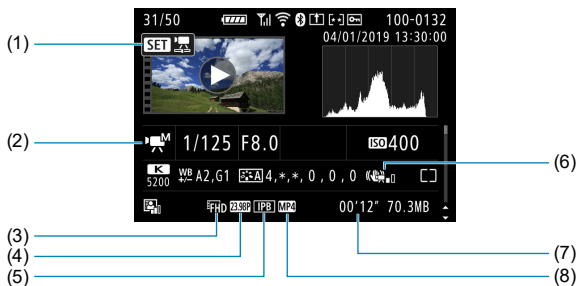

(1) Movie playback

(2) Movie recording mode/Time-lapse
movie/Video snapshot

(3) Image size

(4) Frame rate

(5) Compression method

(6) Movie digital IS

(7) Recording time

(8) Movie recording format

* will be displayed for still photos taken as test shots for time-lapse movies.



- During movie playback, “*,” “*” will be displayed for **[Fineness]** and **[Threshold]** of **[Picture Style]**'s **[Sharpness]**.

Trademarks

- Adobe is a trademark of Adobe Systems Incorporated.
- Microsoft and Windows are trademarks or registered trademarks of Microsoft Corporation in the United States and/or other countries.
- Macintosh and Mac OS are trademarks of Apple Inc., registered in the U.S. and other countries.
- SDXC logo is a trademark of SD-3C, LLC.
- HDMI, HDMI logo, and High-Definition Multimedia Interface are trademarks or registered trademarks of HDMI Licensing LLC.
- The Wi-Fi CERTIFIED logo and the Wi-Fi Protected Setup mark are trademarks of the Wi-Fi Alliance.
- WPS used on camera settings screens and in this manual stands for Wi-Fi Protected Setup.
- The Bluetooth® word mark and logos are registered trademarks owned by Bluetooth SIG, Inc. and any use of such marks by Canon Inc. is under license. Other trademarks and trade names are those of their respective owners.
- All other trademarks are the property of their respective owners.

About MPEG-4 Licensing

"This product is licensed under AT&T patents for the MPEG-4 standard and may be used for encoding MPEG-4 compliant video and/or decoding MPEG-4 compliant video that was encoded only (1) for a personal and non-commercial purpose or (2) by a video provider licensed under the AT&T patents to provide MPEG-4 compliant video. No license is granted or implied for any other use for MPEG-4 standard."

THIS PRODUCT IS LICENSED UNDER THE AVC PATENT PORTFOLIO LICENSE FOR THE PERSONAL USE OF A CONSUMER OR OTHER USES IN WHICH IT DOES NOT RECEIVE REMUNERATION TO (i) ENCODE VIDEO IN COMPLIANCE WITH THE AVC STANDARD("AVC VIDEO")AND/OR (ii) DECODE AVC VIDEO THAT WAS ENCODED BY A CONSUMER ENGAGED IN A PERSONAL ACTIVITY AND/OR WAS OBTAINED FROM A VIDEO PROVIDER LICENSED TO PROVIDE AVC VIDEO. NO LICENSE IS GRANTED OR SHALL BE IMPLIED FOR ANY OTHER USE. ADDITIONAL INFORMATION MAY BE OBTAINED FROM MPEG LA, L.L.C.

SEE [HTTP://WWW.MPEGLA.COM](http://www.mpegla.com)

* Notice displayed in English as required.

Third party software

This product includes third party software.

- AES-128 Library

Copyright (c) 1998-2008, Brian Gladman, Worcester, UK. All rights reserved.

LICENSE TERMS

The redistribution and use of this software (with or without changes) is allowed without the payment of fees or royalties provided that:

1. source code distributions include the above copyright notice, this list of conditions and the following disclaimer;
2. binary distributions include the above copyright notice, this list of conditions and the following disclaimer in their documentation;
3. the name of the copyright holder is not used to endorse products built using this software without specific written permission.

DISCLAIMER

This software is provided 'as is' with no explicit or implied warranties in respect of its properties, including, but not limited to, correctness and/or fitness for purpose.

Use of Genuine Canon Accessories Is Recommended

This product is designed to achieve optimum performance when used with genuine Canon accessories. Therefore, using this product with genuine accessories is highly recommended.

Canon shall not be liable for any damage to this product and/or accidents such as malfunction, fire, etc. caused by the failure of non-genuine Canon accessories (e.g., a leakage and/or explosion of a battery). Please note that repairs arising out of the malfunction of non-genuine accessories will not be covered by the warranty for repairs, although you may request such repairs on a chargeable basis.

-  ● Battery Pack LP-E6N/LP-E6 is dedicated to Canon products only. Using it with an incompatible battery charger or product may result in malfunction or accidents for which Canon cannot be held liable.

Index

Numbers

1-point AF : 128, 135, 140

4K frame capture : 342

4K (movie) : 288

A

Acceleration/deceleration tracking : 560

Access lamp : 49

Accessories : 3

Adobe RGB : 229

AEB (Auto Exposure Bracketing) : 211, 556

AE lock : 161

AF

AF area selection mode : 128, 131

AF-assist beam : 126

AF method : 135

AF Microadjustment : 575

AF operation : 124, 145

AF point red illumination : 127

AF point selection : 132, 140

AF speed : 320

Area AF frame : 89, 90

Beep (Beeper) : 522

Continuous AF : 265

Eye detection AF : 142

Lens drive when AF impossible : 563

Lens electronic MF : 266

Limit AF methods : 564

Manual focusing : 147

Recomposing : 80

AF area selection mode : 128, 131

AF point automatic selection : 129

AF point auto switching : 561

AF start (AF-ON) button : 61

AI FOCUS (AI Focus AF) : 126

AI SERVO (AI Servo AF) : 125

Tracking sensitivity : 559, 561

Album (video snapshot) : 312, 374

Ambience priority (AWB) : 224

Anti-flicker shooting : 261

Aperture-priority AE : 114

Area AF frame : 89, 90

Art bold effect : 363

<A+> (Scene Intelligent Auto) : 76

Aspect ratio → Still image aspect ratio

Attenuator : 296

Autofocus → AF

Auto Lighting Optimizer : 218

Automatic selection (AF) : 129

Auto playback : 383

Auto power off : 513

Auto reset : 509

Auto rotate : 510

Av (Aperture-priority AE) : 114

B

Background blur : 83

Background music : 376

Basic information display : 629

Basic Zone : 38

Battery → Power

Battery grip : 594

B (Bulb) : 119

Beep (Beeper) : 522

Bluetooth function : 399, 464

Address : 471

Connecting : 400

Bracketing

AEB (Auto Exposure Bracketing) : 211

FEB (Flash Exposure Bracketing) :
177

Focus bracketing : 255

White balance bracketing : 228

Built-in flash : 164

Bulb exposure : 119

Bulb timer : 120

buSY : 201

C

[C1]/[C2] (Custom shooting) : 546

Camera

Camera vibration blur : 120, 154, 156

Default settings : 547

Holding the camera : 56

Camera shake : 78

Candlelight : 95

Card requirements : 291, 617

Cards : 10, 30, 48

Card reminder : 205

Formatting : 511

Low-level formatting : 511

Troubleshooting : 50, 598

Write protection : 48

Center-weighted average metering : 158

Certification Logo : 550

Charger : 40, 44

Charging : 44

Chromatic aberration correction : 369

Cleaning (image sensor) : 528

Clipped highlights : 391

Close-up : 93

Color space : 229, 368

Color temperature : 226

Color tone : 234

Continuous (file numbering) : 508

Continuous shooting : 150

Contrast : 218, 234

Copyright information : 548

Creative Assist : 82, 370

Creative filters : 103, 285, 361

Creative filters for movies : 285

Creative Zone : 39

Cropping (images) : 377

Custom Controls : 571

Custom Functions : 551

Customize buttons : 571

Custom shooting mode : 546

Custom white balance : 225

D

Date/time : 516

Daylight saving time : 517

DC coupler : 594

Default settings : 547

Custom Functions : 581

Customizing operations : 581

Custom shooting mode : 546

Flash function settings : 178

My Menu : 586

Depth of field : 116

Depth-of-field preview : 116

Diffraction correction : 209, 369

Digital Lens Optimizer : 208, 368

Digital terminal : 32, 592

Dioptic adjustment : 56

Direct selection (AF point) : 572

Distortion correction : 207, 368

Double-tap : 335

DPOF (Digital Print Order Format) : 354

Dragging : 70

Drive mode : 150

Dust Delete Data : 241

E

Electronic level : 539

Erasing (images) : 350

Err (error codes) : 613

Error messages : 613

Evaluative metering : 158

exFAT : 293, 512

Expanded ISO speed : 213, 215, 322, 620

Exposure compensation : 211

Exposure compensation in M mode with ISO Auto : 118

Exposure level increments : 556

Exposure level indicator : 624

Exposure simulation : 221

External microphone : 296

External Speedlite → Flash

Eyecup : 157

Eye detection AF : 142

Eyepiece cover : 41

F

Face+Tracking : 135, 138

FAT32 : 293, 512

Feature guide : 533

FEB (Flash Exposure Bracketing) : 177

FE lock : 167

File extension : 199, 290

File name : 507

File size : 293, 615, 618

Filter effect (Monochrome) : 235

Fine (Image quality) : 199

Firmware : 550

First-curtain synchronization : 176

Fish-eye effect : 105, 363

Flash exposure compensation : 166, 172

Flash mode : 171, 174

Flash (Speedlite)

Built-in flash : 164

Custom Functions : 177

Effective range : 164

External flash units : 179

FEB (Flash Exposure Bracketing) : 177

FE lock : 166

Flash control (function settings) : 168

Flash exposure compensation : 172

Flash sync speed : 179

Manual flash : 171, 174

Red-eye reduction : 169

Shutter synchronization (1st/2nd curtain) : 171, 176

Slow synchro : 170

Wireless : 172, 175

Flash sync contacts : 31

Focus bracketing : 255

Focusing → AF

Focusing point (AF point) : 128

Focus lock : 80

Focus mode switch : 54

Folder creation/selection : 505

Food : 94

Formatting : 511

Formatting (card initialization) : 511

Frame Grab : 342

Frame rate : 290, 520

Full High-Definition (Full HD) : 288

Full High-Definition (Full HD) (movie) :
288

Fully-press : 542

G

GPS : 473

Grainy B/W : 105, 362

Grid display : 393, 540

Group Photo : 87

H

Half-press : 542

Handheld night scene : 97

HDMI : 325, 344, 543

HDMI HDR : 544

HDMI output : 325

HDR art bold : 106

HDR art embossed : 106

HDR art standard : 106

HDR art vivid : 106

HDR Backlight Control : 98

HDR movie recording : 284

HDR shooting : 251

Headphones : 296

Help : 534

Text size : 535

High-Definition : 288

High-Definition (HD) (movie) : 288

High dynamic range → HDR

High ISO speed noise reduction : 239

Highlight alert : 391

Highlight tone priority : 219

High-speed continuous shooting : 150

Histogram : 389, 540

Hot shoe : 31, 179

Household power : 594

I

ICC profile : 229

Icons : 8

Image browsing (jump display) : 387

Image quality : 199, 615

Image review time : 204

Images

AF point display : 392

Auto playback : 383

Auto reset : 509

Auto rotation : 510

Continuous (file numbering) : 508

Erasing : 350

File numbering : 507

Highlight alert : 391

Histogram : 389

Image review time : 204

Importing (to computer) : 592

Index display : 334

Jump display (image browsing) : 387

Magnifying images : 336

Manual reset : 509

Manual rotation : 349

Playback : 329

Protecting images : 346

Rating : 380

Search conditions : 385

Shooting information : 333, 630

Slide show : 383

TV display : 344

-
- Image search : 385
-
- Importing images to a computer : 592
-
- Index display : 334
-
- INFO button : 62, 332, 538, 622, 623, 625
-
- Interval timer : 258
-
- IPB : 290
-
- ISO speed : 213, 322
- Automatic setting range : 216
 - Auto range (Still photos) : 216
 - ISO Auto range : 216, 614
 - ISO expansion : 215
 - ISO speed range : 322
 - Manual setting range : 215
 - Minimum shutter speed for ISO Auto (Still photos) : 217
 - Setting increments : 556
-
- J**
- JPEG : 615
-
- Jump display : 387
-
- K**
- Kids : 90
-
- L**
- Landscape : 88
-
- Language : 519
-
- Large (image quality) : 199
-
- Large Zone AF : 129
-
- LCD panel : 36
-
- Lens
- Chromatic aberration correction : 209, 369
 - Diffraction correction : 209, 369
 - Digital Lens Optimizer : 208, 368
 - Distortion correction : 207, 368
 - Focus mode switch : 54
 - Lock release : 55
 - Optical aberration correction : 206, 368
 - Peripheral illumination correction : 207, 368
-
- Lens electronic MF : 266
-
- Live View shooting : 71, 77
- 1-point AF : 135
 - AF method : 135
 - AF operation : 124
 - Aspect ratio : 202
 - Creative filters : 103
 - Exposure simulation : 221
 - Eye detection AF : 142
 - Face+Tracking : 138
 - Focus bracketing : 255
 - Grid display : 393, 540
 - Information display : 622
 - Manual focusing : 147
 - Metering timer : 220
 - Possible shots : 614
 - Quick Control : 67
 - Spot AF : 135
 - Zone AF : 136
-
- Location information : 473
-
- LOCK : 545
-
- Long (bulb) exposures : 119
-
- Long Exposure Noise Reduction : 238
-
- Low-speed continuous shooting : 151
-

M

Macro photography : 93

Magnifying images : 144, 147

Main dial : 58

Malfunction : 595

Manual exposure : 117

Manual focus : 147

Manual reset : 509

Manual selection(AF point) : 132

Maximum burst : 201, 615

Medium (image quality) : 199

Memory cards → Cards

Menu : 63

 Custom Functions : 552

 Dimmed menu items : 66

 Function settings : 502

 Movie recording : 274

 My Menu : 583

 Playback : 330

 Setting procedure : 64

 Still photo shooting : 193

 Wireless communication functions :
 396

Metering mode : 158

Metering timer : 220

MF (Manual focusing) : 147

MF peaking : 149

Microphone : 296

Miniature effect : 106, 108, 363

Miniature effect movie : 287

Mirror lockup : 263

M (Manual exposure) : 117

Mode dial : 38, 58

Monochrome : 83, 231, 235

Movies : 273

 AE lock : 278

 AF method : 135

 Attenuator : 296

 Autoexposure recording : 277

 Auto slow shutter : 324

 Cards that can record movies : 617

 Compression method : 290

 Creative filters : 285

 Editing : 340

 Editing out first and last scenes : 340

 External microphone : 296

 File size : 293, 618

 Frame Grab : 342

 Frame rate : 290

 Grid display : 540

 HDMI output : 325, 543

 HDR movie recording : 284

 Headphones : 296

 Information display : 622, 625

 Manual exposure recording : 279

 Metering timer : 220

 Microphone : 296

 Movie digital IS : 298

 Movie recording size : 288

 Movie Servo AF : 317, 319, 320

 Movie shooting button : 33

 Playback : 337

 Quick Control : 67

 Recording coverage : 289

 Recording time : 294, 618

 Servo AF speed : 320

Servo AF tracking sensitivity : 319

Sound recording/Sound-recording level : 295

Time-lapse movie : 300

TV display : 344

Video snapshot : 312

Video snapshot album : 312

Wind filter : 295

MP4 : 290

Multi-Controller 1/Multi-Controller 2 : 60

Multi-function lock : 545

Multiple exposure : 245

Multi Shot Noise Reduction : 239

My Menu : 583

N

Night Portrait : 96

Noise reduction

- High ISO speed : 239
- Long exposures : 238

Non-Canon flash units : 179

Normal (Image quality) : 199

NTSC : 290, 520

Number of pixels : 615

O

One-Shot AF : 125

P

PAL : 290, 520

Panning : 91

Partial metering : 158

Part names : 31

Peripheral illumination correction : 207, 368

Photobook set-up : 358

Picture Style : 230, 233, 236

Playback : 329

Portrait : 86

Positioning hole : 33

Possible recording time (movie) : 618

Possible shots : 614

Power : 52

- Auto power off : 513
- Battery information : 524
- Battery level : 53
- Charging : 44
- Household power : 594
- Recharge performance : 524

P (Program AE) : 110

Pressing completely : 57

Pressing halfway : 57, 542

Printing

- Photobook set-up : 358
- Print order (DPOF) : 354

Program AE : 110

- Program shift : 111

Protecting images : 346

Q

[Q] (Quick Control) : 67

Quick Control : 67

Quick control dial : 59

R

Rating : 380

RAW : 199, 200

RAW image processing : 364

RAW+JPEG : 199, 615

Red-eye reduction : 169

Reduced display : 334
 Release shutter without card : 205
 Remote controller : 155
 Remote control terminal : 156
 Remote switch : 156
 Resizing : 379
 Rotating (images) : 349, 510
S
 Safety instructions : 25
 Safety shift : 558
 Saturation : 234
 Scene icons : 81
 Scene Icons : 627
 Scene Intelligent Auto : 76
 <SCN> (Special scene mode) : 38, 84
 Screen : 30, 51
 Angle adjustment : 51
 Brightness : 514
 SD/SDHC/SDXC cards → Cards
 Second-curtain synchronization : 171, 176
 Self-timer : 153
 Sensitivity → ISO speed
 Sensor cleaning : 528
 Sepia (Monochrome) : 235
 Serial number : 33
 Servo AF
 Initial AF Point : 566
 Movie Servo AF : 317, 319, 320
 SERVO : 125
 SERVO (Servo AF) : 125
 Sharpness : 234
 Shooting information display : 539, 622

Shooting mode
 <A+> (Scene Intelligent Auto) : 76
 Av (Aperture-priority AE) : 114
 B (Bulb) : 119
 [C1]/[C2] (Custom shooting) : 546
 Creative filters : 103
 M (Manual exposure) : 117
 P (Program AE) : 110
 SCN (Special scene mode) : 84
 Tv (Shutter-priority AE) : 112
 Shooting mode guide : 532
 Shutter button : 57
 Shutter button functions : 542
 Shutter-priority AE : 112
 Shutter synchronization : 171, 176
 Single-image display : 332
 Single shooting : 150
 Slide show : 383
 Small (image quality) : 199
 Soft focus : 105, 362
 Software : 590
 Instruction Manual : 591
 Sound recording/Sound-recording level : 295
 Speaker : 32
 Special scene mode (SCN) : 84
 Sports : 89
 Spot AF : 128, 135, 140
 Spot metering : 158
 sRGB : 229
 Still image aspect ratio : 202, 616
 Strap : 41

T

Temperature warning : 269, 326

Tilt correction : 378

Time-lapse movie : 300

Time zone : 516

Tone priority : 219

Toning effect (Monochrome) : 235

Touch beeping : 522

Touch operation : 70, 335, 521

Touch Shutter : 72

Toy camera effect : 105, 363

Tracking sensitivity : 559

Tripod socket : 33

Troubleshooting : 595

TV display : 344

Tv (Shutter-priority AE) : 112

U

UHS-II/UHS-I : 10

USB (digital) terminal : 592

UTC (Coordinated Universal Time) : 477

V

Vari-angle screen : 51

Video snapshot : 312

Video system : 520

Viewfinder

Dioptric adjustment : 56

Electronic level : 536

Grid lines : 540

Information display : 536

Volume (movie playback) : 338, 339

W

Warning icon : 570

Water painting effect : 105, 363

WB (White balance) : 222

White balance (WB) : 222

Ambience priority : 224

Auto : 224

Bracketing : 228

Color temperature setting : 226

Correction : 227

Custom : 225

White priority (AWB) : 224

Wi-Fi function : 395

Android : 399

Camera access point mode : 462

Camera Connect : 399, 404

CANON IMAGE GATEWAY : 444

Clearing wireless communication settings : 480

Connection history : 467

Edit device information : 422, 478

EOS Utility : 426

Erase connection information : 479

Image Transfer Utility 2 : 431

iOS : 399

IP address : 462

MAC address : 481

Network : 409, 427, 434

Network settings : 497

Nickname : 479

Notes : 494

PictBridge : 434

Printer : 434
Printing : 436
Print order : 439
Reconnecting : 467
Remote operation : 404
Resize image : 412, 417, 452
Sending all images on the card : 418, 454
Sending images that match search conditions : 419, 456
Send selected : 414, 451
SSID : 409, 427, 434
Switch network : 459
Viewable images : 422
View info screen : 481
Viewing images : 404
Virtual keyboard : 482
Wi-Fi settings : 470
WPS (Wi-Fi Protected Setup) : 458
Wind filter : 295
Wireless communication : 395
Wireless flash photography : 180
Z
Zone AF : 128, 136, 140



The descriptions in this Instruction Manual are current as of September 2019. For information on the compatibility with any products introduced after this date, contact any Canon Service Center. For the latest version Instruction Manual, refer to the Canon Web site.