

Canon

EOS
REBEL SL3

EOS 200D II

Advanced User Guide



Introduction

Before Starting to Shoot, Be Sure to Read the Following

To avoid botched pictures and accidents, first read the “Safety Precautions” (📖22) and “Handling Precautions” (📖25). Also, read this manual carefully to ensure that you use the camera correctly.

Refer to This Manual while Using the Camera to Further Familiarize Yourself with the Camera

While reading this manual, take a few test shots and see how they come out. You can then better understand the camera. Be sure to store this manual safely, too, so that you can refer to it again when necessary.

Testing the Camera Before Use and Liability

After shooting, play images back and check whether they have been properly recorded. If the camera or memory card is faulty and the images cannot be recorded or downloaded to a computer, Canon cannot be held liable for any loss or inconvenience caused.

Copyrights

Copyright laws in your country may prohibit the use of your recorded images or copyrighted music and images with music on the memory card for anything other than private enjoyment. Also be aware that certain public performances, exhibitions, etc. may prohibit photography even for private enjoyment.

Item Check List

Before starting, check that all the following items are included with your camera. If anything is missing, contact your dealer.



Camera
(with eyecup and body cap)



Strap



**Battery Pack
LP-E17**
(with protective cover)



**Battery Charger
LC-E17**

- **The camera does not come with the Software CD-ROM, an interface cable or HDMI cable.**
- If you purchased a Lens Kit, check that the lenses are included.
- Be careful not to lose any of the above items.



- When you need Lens Instruction Manuals, download them from the Canon Web site.

The Lens Instruction Manuals (PDF files) are for lenses sold individually. Note that when purchasing the Lens Kit, some of the accessories included with the lens may not match those listed in the Lens Instruction Manual.



- Software can be downloaded from the Canon Web site (📖482).

Quick Start Guide

1



Insert the battery (📖37).

- Upon purchase, charge the battery to start using (📖35).

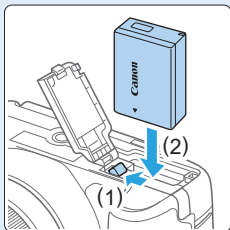

2

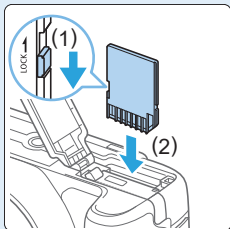

Insert the card (📖37).

- With the card's label facing toward the back of the camera, insert it into the card slot.

3

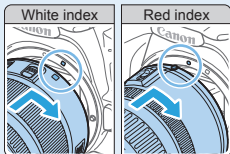

Attach the lens (📖47).

- Align the lens's white or red mount index with the camera's mount index of the same color to attach the lens.

4

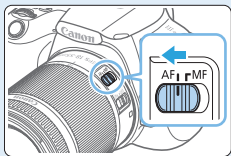

Set the lens's focus mode switch to <AF> (📖 47).

5

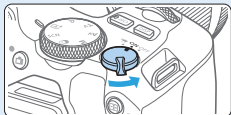

Set the power switch to <ON>, then set the Mode Dial to <A+> (Scene Intelligent Auto) (📖 70).

- All the necessary camera settings will be set automatically.

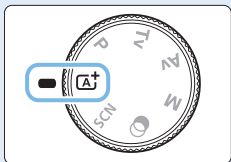

6

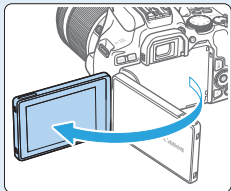

Flip out the LCD monitor (📖 40).

- When the LCD monitor displays the date/time/zone setting screen, see page 43.

7



Focus on the subject (📖 50).

- Look through the viewfinder and aim the viewfinder center over the subject.
- Press the shutter button halfway, and the camera will focus on the subject.
- If necessary, lift the flash with your fingers.

8

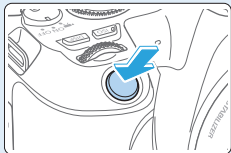

Take the picture (📖 50).

- Press the shutter button completely to take the picture.

9

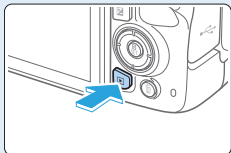

Review the picture.

- The image just captured will be displayed for approx. 2 sec. on the LCD monitor.
- To display the image again, press the <▶> button (📖 101).

- To shoot while looking at the LCD monitor, see “Shooting with the LCD Monitor (Live View Shooting)” (📖 180).
- To view the images captured so far, see “Image Playback” (📖 101).
- To delete images, see “Erasing Images” (📖 310).

Compatible Cards

The following cards can be used with the camera regardless of capacity.

If the card is new or was previously formatted (initialized) by another camera or computer, format the card with this camera (66).

- **SD/SDHC*/SDXC*** memory cards

* UHS-I cards supported.

Cards that Can Record Movies

When recording movies, use a high-capacity card with ample performance (fast enough writing and reading speeds) for the movie recording size.



In this manual, “card” refers to SD memory cards, SDHC memory cards, and SDXC memory cards.

*** The camera does not come with a card for recording photos/movies. Please purchase it separately.**

Chapters







Introduction	2
Getting Started and Basic Camera Operations	34
Basic Shooting and Image Playback	69
Setting the AF and Drive Modes	103
Image Settings	114
Advanced Operations for Photographic Effects	146
Flash Photography	168
Shooting with the LCD Monitor (Live View Shooting)	180
Shooting Movies	217
Handy Features	259
Image Playback	280
Post-Processing Images	328
Wireless Features	344
Customizing the Camera	445
Reference	459
Software Start Guide / Downloading Images to a Computer	481

Contents by Purpose





Shooting

- Shoot automatically → 69 - 100 (Basic Zone modes)
- Shoot continuously → 112 (Continuous shooting)
- Take a picture of yourself in a group → 206 (Self-timer)
- Freeze the action → 149 (**Tv** Shutter-priority AE)
- Blur the action → 149 (**Tv** Shutter-priority AE)
- Shoot with effects of your choice → 76 (Creative Assist)
- Blur the background → 152 (**Av** Aperture-priority AE)
- Keep the background in sharp focus → 152 (**Av** Aperture-priority AE)
- Adjust the image brightness (exposure) → 160 (Exposure compensation)
- Shoot in low light → 78, 169 (Flash photography)
→ 118 (ISO speed setting)
- Shoot without flash → 175 (Flash Off)
- Shoot fireworks at night → 157 (Bulb exposure)
- Shoot while viewing the LCD monitor → 180 (Live View shooting)
- Shoot with creative effects → 93, 188 (Creative filters)
- Take a Self Portrait → 210 (Self Portrait)
- Shoot movies → 217 (Movie shooting)















Image Quality

- Shoot with image effects matching the subject →  121 (Picture Style)
 - Make a large-size print of the picture →  115 (, , RAW, CRAW)
 - Take a lot of pictures →  115 (, , S2)
-



AF (Focusing)

- Change the point of focus →  108 ( AF point selection)
 - Shoot a moving subject →  83,  84,  106 (AI Servo AF)
-

Playback

- View the images on the camera →  101 ( Playback)
 - Search for pictures quickly →  281 ( Index display)
 285 ( Image browsing)
 - Rate images →  288 (Ratings)
 - Prevent important images from accidental erasure →  307 ( Image protect)
 - Delete unnecessary images →  310 ( Delete)
 - Auto play back photos and movies →  303 (Slide show)
 - View the photos and movies on a TV set →  305 (TV set)
 - Adjust the LCD monitor brightness →  262 (LCD monitor brightness)
 - Apply special effect to images →  329 (Creative filters)
-

Wireless Features

- **Send images to a smartphone** →  349 (Communicate with smartphone)
- **Send images to a computer** →  378 (Use with software)
- **Print pictures** →  381 (Print from Wi-Fi printer)
- **Share images online** →  391 (Send images to a Web service)

Index to Features

Power

- Battery
 - Charging (📖35)
 - Installing/Removing (📖37)
 - Battery level (📖42)
 - Checking battery information (📖460)
- Household power outlet (📖461)
- Auto power off (📖41)

Cards

- Installing/Removing (📖37)
- Formatting (📖66)
- Releasing shutter without card (📖260)

Lens

- Attaching/Detaching (📖47)
- Zoom (📖48)

Basic Settings

- Dioptic adjustment (📖49)
- Language (📖46)
- Date/Time/Zone (📖43)
- Beeper (📖260)

LCD Monitor

- Using the LCD monitor (📖40)
- LCD off/on button (📖272)
- Brightness adjustment (📖262)
- Touch screen (📖63)
- Display level settings (📖51)
- Feature guide (📖55)

Recording Images

- Creating/Selecting a folder (📖263)
- File numbering (📖265)

AF

- AF operation (📖104)
- AF point selection (📖108)
- Manual focusing (📖111)
- Eye detection AF (📖204)
- Continuous AF (📖205)
- MF peaking settings (📖213)

Drive

- Drive mode (📖112)
- Continuous shooting (📖112)

Image Quality

- Image-recording quality (📖115)
- Picture Style (📖121)
- White balance (📖129)
- Auto Lighting Optimizer (📖136)
- Noise reduction for long exposures (📖139)
- Noise reduction for high ISO speeds (📖138)
- Lens aberration correction (📖141)
- Highlight tone priority (📖137)
- Color space (📖145)

Shooting

- Shooting mode (📖30)
- ISO speed (📖118)
- Bulb (📖157)
- Metering mode (📖158)
- Mirror lockup (📖165)
- Remote control (📖463)

Exposure Adjustment

- Exposure compensation (📖160)
- Exposure compensation with M+ISO Auto (📖156)
- AEB (📖162)
- AE lock (📖164)

Flash

- Built-in flash (📖169)
- External flash (📖174)
- Flash function settings (📖175)

Live View Shooting

- Live View shooting (📖180)
- Aspect ratio (📖192)
- AF operation (📖195)
- AF method (📖197)
- Creative filters (📖188)
- Self-timer (📖206)
- Touch Shutter (📖208)
- Self portrait (📖210)

Movie Shooting

- Movie shooting (📖217)
- AF method (📖197)
- Movie recording size (📖228)
- Movie Servo AF (📖253)
- Sound recording (📖251)
- Manual exposure (📖221)
- Digital zoom (📖231)
- HDR movie shooting (📖234)
- Creative filters for movies (📖235)
- Video snapshot (📖245)
- Time-lapse movie (📖238)
- Remote control shooting (📖463)

Playback

- Image review time (📖261)
- Single-image display (📖101)
- Shooting information (📖323)
- Index display (📖281)
- Image browsing (Jump display) (📖282)
- Magnified view (📖284)
- Image rotation (📖287)
- Rating (📖288)
- Movie playback (📖296)
- Slide show (📖303)
- Viewing images on a TV set (📖305)
- Protect (📖307)
- Erasing (📖310)
- Touch playback (📖285)
- Print Order (DPOF) (📖316)
- Photobook Set-up (📖320)

Image Editing

- Creative filters (📖329)
- Resizing (📖338)
- Cropping (📖340)

Customization

- Custom Functions (C.Fn) (📖446)
- My Menu (📖455)

Software





- Software Start Guide (📖482)
- Software Instruction Manual (📖483)

Wireless Features







- Communicate with smartphone (📖349)
- Auto send images to smartphones (📖362)
- Remote control (EOS Utility) (📖374)
- Auto send images to computers (📖378)
- Print from Wi-Fi printer (📖381)
- Send images to a Web service (📖391)
- Clear wireless settings (📖425)

Conventions in This Manual

Icons in this Manual

-  : Indicates the Main Dial.
-  : Indicate up, down, left, and right on the  cross keys respectively.
-  : Indicates the Setting button.

* In addition to the above, the icons and symbols used on the camera's buttons and displayed on the LCD monitor are also used in this manual when discussing relevant operations and functionality.

-  : This icon at the upper right of the page titles indicates that the function is available only in the Creative Zone modes (31).
- ***) : Reference page numbers for more information.
-  : Warning to prevent shooting problems.
-  : Supplemental information.
-  : Tips or advice for better shooting.
-  : Troubleshooting advice.

Basic Assumptions for Operational Instructions and Notes on Sample Photos

- All operations described in this manual assume that the power switch is set to **<ON>** (41).
- It is assumed that all the menu settings and Custom Functions are set to their defaults.
- The illustrations in this manual describe the camera attached with the EF-S18-55mm f/4-5.6 IS STM lens as an example.
- The sample photos displayed on the camera and used in this manual are only for illustrative purposes to show the effects more clearly.

Contents

Introduction 2

Item Check List.....	3
Quick Start Guide	4
Compatible Cards.....	7
Chapters	8
Contents by Purpose	9
Index to Features.....	12
Conventions in This Manual	15
Contents	16
Safety Precautions.....	22
Handling Precautions.....	25
Part Names.....	28

Getting Started and Basic Camera Operations 34

Charging the Battery.....	35
Installing and Removing the Battery and Card	37
Using the LCD Monitor	40
Turning on the Power	41
Setting the Date, Time, and Time Zone	43
Selecting the Interface Language.....	46
Attaching and Detaching a Lens.....	47
Basic Shooting Operations	49
Setting the Screen Display Level.....	51
Quick Control for Shooting Functions	57
Menu Operations and Configurations.....	59
Operating the Camera with Touch Screen.....	63
Formatting Memory Cards	66
Switching the LCD Monitor Display	68

Basic Shooting and Image Playback 69

Fully Automatic Shooting (Scene Intelligent Auto).....	70
Full Auto Techniques (Scene Intelligent Auto)	74
Special Scene Mode.....	78
Shooting Portraits	79
Shooting Portraits with Smooth Skin Tone.....	80
Shooting Group Photos	81
Shooting Landscapes	82
Shooting Moving Subjects	83
Photographing Children.....	84
Shooting Close-ups	85
Shooting Food	86
Shooting Candlelight Portraits	87
Shooting Night Portraits (With a Tripod).....	88
Shooting Night Scenes (Handheld)	89
Shooting Backlit Scenes.....	90
Shooting with Creative Filter Effects.....	93
Quick Control.....	99
Adjusting the Brightness	100
Image Playback	101

Setting the AF and Drive Modes 103

Changing the Autofocus Operation.....	104
Selecting the AF Point	108
Subjects Difficult to Focus on	110
Selecting the Drive Mode.....	112

Image Settings 114

Setting Image Quality	115
Setting the ISO Speed for Still Photos.....	118
Selecting a Picture Style.....	121
Customizing a Picture Style.....	124
Registering a Picture Style	127

Matching the Light Source	129
Adjusting the Color Tone for the Light Source	133
Auto Correction of Brightness and Contrast	136
Highlight Tone Priority	137
Setting Noise Reduction	138
Correction of Lens Aberrations due to Optical Characteristics	141
Setting the Color Reproduction Range	145
Advanced Operations for Photographic Effects	146
Program AE (P Mode).....	147
Conveying the Subject's Movement (Tv Mode).....	149
Changing the Depth of Field (Av Mode)	152
Manual Exposure (M Mode)	155
Changing the Metering Mode	158
Setting the Desired Exposure Compensation.....	160
Auto Exposure Bracketing	162
Locking the Exposure	164
Mirror Lockup to Reduce Camera Vibration Blur	165
AF-Assist Beam Settings	167
Flash Photography	168
Using the Built-in Flash.....	169
Using an External Speedlite	174
Setting the Flash Function.....	175
Shooting with the LCD Monitor (Live View Shooting)	180
Shooting with the LCD Monitor	181
Shooting Function Settings.....	187
Shooting with Creative Filter Effects.....	188
Menu Function Settings.....	192
Changing the Autofocus Operation.....	195
Focusing with AF	197
Focusing on People's Eyes	204
Setting Continuous AF	205

Using the Self-timer	206
Shooting with the Touch Shutter	208
Taking a Self Portrait (Selfie)	210
MF: Focusing Manually.....	212

Shooting Movies 217

Shooting Movies	218
Shooting Function Settings.....	227
Setting the Movie Recording Size.....	228
Using Movie Digital Zoom.....	231
Movie Digital IS.....	232
Recording HDR Movies	234
Shooting Movies with Creative Filter Effects	235
Shooting Time-lapse Movies.....	238
Recording Video Snapshots	245
Menu Function Settings.....	250

Handy Features 259

Handy Features	260
Automatic Sensor Cleaning	273
Appending Dust Delete Data	274
Manual Sensor Cleaning	276
HDMI Output Resolution.....	278
RAW Playback on an HDR TV.....	279

Image Playback 280

Searching for Images Quickly.....	281
Magnifying Images.....	284
Playing Back with the Touch Screen.....	285
Rotating the Image	287
Setting Ratings	288
Filtering Images for Playback	291
Quick Control for Playback	293
Enjoying Movies.....	295

Playing Back Movies.....	296
Editing a Movie's First and Last Scenes.....	299
Grabbing a Frame from 4K Movies or 4K Time-Lapse Movies.....	301
Slide Show (Auto Playback).....	303
Playback on a TV.....	305
Protecting Images.....	307
Erasing Images.....	310
Preparing to Print.....	313
Printing.....	315
Digital Print Order Format (DPOF).....	316
Specifying Images for a Photobook.....	320
Shooting Information Display.....	323
Post-Processing Images	328
Applying Creative Filter Effects.....	329
Applying Your Favorite Effects (Creative Assist).....	332
Red-eye Correction.....	334
Editing Video Snapshot Albums.....	335
Resizing JPEG Images.....	338
Cropping JPEG Images.....	340
Specifying Initial Image Display When Playback Begins.....	343
Wireless Features	344
What You Can Do via Wireless Communication Functions.....	345
Tab Menus: Wireless Tab.....	346
Selection of Wi-Fi/Bluetooth Connection.....	347
Connecting to a Smartphone.....	349
Connecting to a Computer via Wi-Fi.....	374
Connecting to a Printer via Wi-Fi.....	381
Sending Images to a Web Service.....	391
Wi-Fi Connection via Access Points.....	405
Connecting to a Wireless Remote Control.....	410
Reconnecting via Wi-Fi.....	413

Registering Multiple Connection Settings	415
Wi-Fi Settings	416
Bluetooth Settings.....	417
Changing the Nickname	418
Geotagging Images with GPS Information from Other Devices	419
Changing or Deleting Connection Settings.....	423
Clearing Wireless Communication Settings to Default	425
View Info Screen.....	426
Virtual Keyboard Operation	427
Responding to Error Messages	428
Wireless Communication Function Notes	439
Security.....	441
Checking Network Settings.....	442
Wireless Communication Status.....	443
Customizing the Camera	445
Setting Custom Functions.....	446
Custom Function Setting Items.....	448
Registering My Menu.....	455
Reference	459
Checking the Battery Information	460
Using a Household Power Outlet.....	461
Remote Control Shooting	463
Removing the Eyecup.....	464
Troubleshooting Guide	465
Error Codes	477
Software Start Guide / Downloading Images to a Computer	481
Software Overview.....	482
Downloading and Viewing the Software Instruction Manuals (PDF Files).....	483
Downloading Images to a Computer	484
Index.....	486

Safety Precautions

The following precautions are provided to prevent harm or injury to yourself and others. Make sure to thoroughly understand and follow these precautions before using the product.



Warnings: Follow the warnings below. Otherwise, death or serious injuries may result.

- To prevent fire, excessive heat, chemical leakage, explosions, and electrical shock, follow the safeguards below:
 - Do not use any batteries, power sources, or accessories not specified in the Instruction Manual. Do not use any home-made or modified batteries, or the product if it is damaged.
 - Do not short-circuit, disassemble, or modify the battery. Do not apply heat or solder to the battery. Do not expose the battery to fire or water. Do not subject the battery to strong physical shock.
 - Do not insert the battery's plus and minus ends incorrectly.
 - Do not recharge the battery in temperatures outside the allowable charging (working) temperature range. Also, do not exceed the recharge time indicated in the Instruction Manual.
 - Do not insert any foreign metallic objects into the electrical contacts of the camera, accessories, connecting cables, etc.
- When disposing of a battery, insulate the electrical contacts with tape. Contact with other metallic objects or batteries may cause a fire or an explosion.
- If excessive heat, smoke, or fumes are emitted when recharging the battery, immediately unplug the battery charger from the power outlet to stop recharging. Otherwise, it may cause a fire, heat damage, or electrical shock.
- If the battery leaks, changes color, deforms, or emits smoke or fumes, remove it immediately. Be careful not to get burned in the process. It may cause a fire, electrical shock or burns if you keep using it.
- Prevent any battery leakage from contacting your eyes, skin, and clothing. It can cause blindness or skin problems. If the battery leakage comes in contact with your eyes, skin, or clothing, flush the affected area with lots of clean water without rubbing it. See a physician immediately.
- Do not leave any cords near a heat source. It can deform the cord or melt the insulation and cause a fire or electrical shock.
- Do not hold the camera in the same position for long periods of time. Even if the camera does not feel too hot, prolonged contact with the same body part may cause skin redness or blistering due to low-temperature contact burns. Using a tripod is recommended when using the camera in very hot places or for people with circulation problems or poor skin sensation.
- Do not fire the flash at anyone driving a car or other vehicle. It may cause an accident.
- When the camera or accessories are not in use, make sure to remove the battery, and disconnect the power plug and connecting cables from the equipment before storing. This is to prevent electrical shock, excessive heat, fire, and corrosion.

- Do not use the equipment where there is flammable gas. This is to prevent an explosion or a fire.
- If you drop the equipment and the casing breaks open to expose the internal parts, do not touch the exposed internal parts. There is a possibility of an electrical shock.
- Do not disassemble or modify the equipment. High-voltage internal parts can cause electrical shock.
- Do not look at the sun or an extremely bright light source through the camera or lens. Doing so may damage your vision.
- Keep equipment out of the reach of children and infants, including when in use. Straps or cords may accidentally cause choking, electrical shock, or injury. Choking or injury may also occur if a child or infant accidentally swallows a camera part or accessory. If a child or infant swallows a part or accessory, consult a physician immediately.
- Do not use or store the equipment in dusty or humid places. Likewise, keep the battery away from metallic items and store it with its protective cover attached to prevent short-circuit. This is to prevent fire, excessive heat, electrical shock, and burns.
- Before using the camera inside an airplane or hospital, check if it is allowed. Electromagnetic waves emitted by the camera may interfere with the plane's instruments or the hospital's medical equipment.
- To prevent a fire and electrical shock, follow the safeguards below:
 - Always insert the power plug all the way in.
 - Do not handle a power plug with wet hands.
 - When unplugging a power plug, grasp and pull the plug instead of the cord.
 - Do not scratch, cut, or excessively bend the cord or put a heavy object on the cord. Also do not twist or tie the cords.
 - Do not connect too many power plugs to the same power outlet.
 - Do not use a cord whose wire is broken or insulation is damaged.
- Unplug the power plug periodically and clean off the dust around the power outlet with a dry cloth. If the surrounding is dusty, humid, or oily, the dust on the power outlet may become moist and short-circuit the outlet, causing a fire.
- Do not connect the battery directly to an electrical outlet or a car's cigarette lighter outlet. The battery may leak, generate excessive heat or explode, causing fire, burns, or injuries.
- A thorough explanation of how to use the product by an adult is required when the product is used by children. Supervise children while they are using the product. Incorrect usage may result in electrical shock or injury.
- Do not leave a lens or lens-attached camera in the sun without the lens cap attached. Otherwise, the lens may concentrate the sun's rays and cause a fire.
- Do not cover or wrap the product with a cloth when using it. Doing so may trap heat within and cause the casing to deform or catch fire.
- Be careful not to get the camera wet. If you drop the product in the water or if water or metal get inside the product, promptly remove the battery. This is to prevent fire, electrical shock, and burns.
- Do not use paint thinner, benzene, or other organic solvents to clean the product. Doing so may cause fire or a health hazard.



Cautions: Follow the cautions below. Otherwise, physical injury or property damage may result.

- Do not use or store the product in a high-temperature location such as inside a car under the hot sun. The product may become hot and cause burns. Doing so may also cause battery leakage or explosion, which will degrade the performance or shorten the life of the product.
- Do not carry the camera around when it is attached to a tripod. Doing so may cause an injury or an accident. Also make sure the tripod is sturdy enough to support the camera and lens.
- Do not leave the product in a low-temperature environment for an extended period of time. The product will become cold and may cause injury when touched.
- Do not fire the flash near the eyes. It may hurt the eyes.

Handling Precautions

Camera Care

- This camera is a precision instrument. Do not drop it or subject it to physical shock.
- The camera is not waterproof and cannot be used underwater. If you accidentally drop the camera into water, promptly consult the nearest Canon Service Center. Wipe off any water droplets with a dry and clean cloth. If the camera has been exposed to salty air, wipe it with a clean, well-wrung wet cloth.
- Never leave the camera near anything having a strong magnetic field such as a magnet or electric motor. Also, avoid using or leaving the camera near anything emitting strong radio waves, such as a large antenna. Strong magnetic fields can cause camera misoperation or destroy image data.
- Do not leave the camera in excessive heat, such as in a car in direct sunlight. High temperatures can cause the camera to malfunction.
- The camera contains precision electronic circuitry. Never attempt to disassemble the camera yourself.
- Do not block the mirror operation with your finger, etc. Doing so may cause a malfunction.
- Use only a commercially-available blower to blow away dust when it adheres to the lens, viewfinder, reflex mirror, focusing screen, etc. Do not use cleaners that contain organic solvents to clean the camera body or lens. For stubborn dirt, take the camera to the nearest Canon Service Center.
- Do not touch the camera's electrical contacts with your fingers. This is to prevent the contacts from corroding. Corroded contacts can cause camera malfunction.
- If the camera is suddenly brought in from the cold into a warm room, condensation may form on the camera and internal parts. To prevent condensation, first put the camera in a sealed plastic bag and let it adjust to the warmer temperature before taking it out of the bag.
- If condensation forms on the camera, do not use the camera. This is to avoid damaging the camera. If there is condensation, remove the lens, card and battery from the camera, and wait until condensation has evaporated before using the camera.

- If the camera will not be used for an extended period, remove the battery and store the camera in a cool, dry, well-ventilated location. Even while the camera is in storage, press the shutter button a few times once in a while to check that the camera is still working.
- Avoid storing the camera where there are chemicals that result in rust and corrosion such as in a chemical lab.
- If the camera has not been used for an extended period, test all its functions before using it. If you have not used the camera for some time or if there is an important shoot such as a foreign trip coming up, have the camera checked by your nearest Canon Service Center or check the camera yourself and make sure it is working properly.
- If you repeat continuous shooting or perform Live View shooting or movie shooting for a prolonged period, the camera may become hot. This is not a malfunction.
- If there is a bright light source inside or outside the image area, ghosting may occur.

LCD Monitor

- Although the LCD monitor is manufactured with very high precision technology with over 99.99% effective pixels, 0.01% or fewer of the pixels may be dead, and there may also be spots of black, red, or other colors. Dead pixels are not a malfunction. They do not affect the images recorded.
- If the LCD monitor is left on for a prolonged period, screen burn-in may occur where you see remnants of what was displayed. However, this is only temporary and will disappear when the camera is left unused for a few days.
- The LCD monitor display may seem slightly slow in low temperatures, or look black in high temperatures. It will return to normal at room temperature.

Cards

To protect the card and its recorded data, note the following:

- Do not drop, bend, or wet the card. Do not subject it to excessive force, physical shock, or vibration.
- Do not touch the card's electronic contacts with your fingers or anything metallic.
- Do not affix any stickers, etc. on the card.

- Do not store or use the card near anything that has a strong magnetic field, such as a TV set, speakers, or magnets. Also avoid places prone to having static electricity.
- Do not leave the card in direct sunlight or near a heat source.
- Store the card in a case.
- Do not store the card in hot, dusty, or humid locations.

Smudges Adhering to the Front of the Sensor

Besides dust entering the camera from outside, in rare cases, lubricant from the camera's internal parts may adhere to the front of the sensor. If smudges are visible on the images, having the sensor cleaned by a Canon Service Center is recommended.

Lens

After detaching the lens from the camera, put down the lens with the rear end up and attach the rear lens cap to avoid scratching the lens surface and electrical contacts (1).

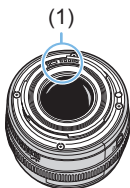

Part Names

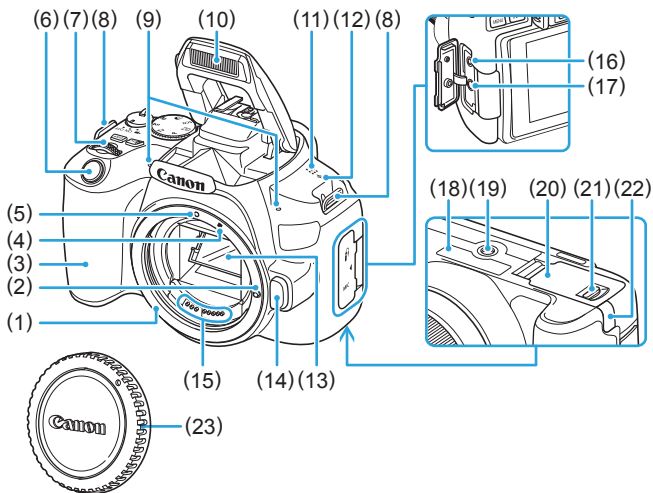

- | | |
|--|---|
| (1) Lens mount | (13) Mirror |
| (2) Lens lock pin | (14) Lens release button |
| (3) Grip | (15) Contacts |
| (4) EF-S lens mount index | (16) Remote control terminal |
| (5) EF lens mount index | (17) External microphone IN terminal |
| (6) Shutter button | (18) Serial number |
| (7) Main Dial | (19) Tripod socket |
| (8) Strap mount | (20) Card slot/Battery compartment cover |
| (9) Built-in microphones | (21) Card slot/Battery compartment cover lock |
| (10) Built-in flash/AF-assist beam emitter | (22) DC cord hole |
| (11) Speaker | (23) Body cap |
| (12) $\langle \ominus \rangle$ Focal plane mark | |

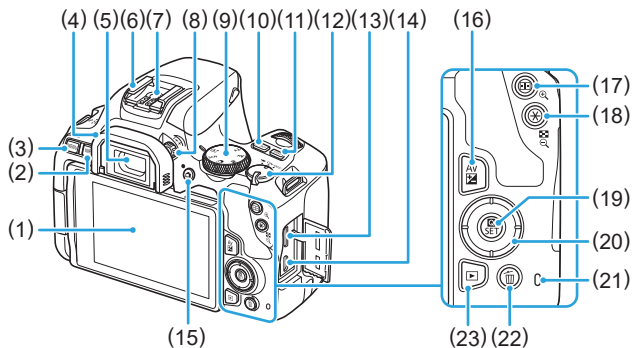

- (1) LCD monitor/Touch screen
Opens to the left about 180° and rotates up and down.
- (2) <INFO> (Info) button
- (3) <MENU> (Menu) button
Used to display menu screens.
- (4) Eyecup
- (5) Viewfinder eyepiece
- (6) Hot shoe
- (7) Flash sync contacts
- (8) Dioptic adjustment knob
- (9) Mode Dial
- (10) <ISO> (ISO speed setting) button
- (11) <DISP> (Display) button
- (12) Power switch
- (13) HDMI mini OUT terminal
- (14) Digital terminal
- (15) <📷> (Live View shooting/Movie shooting) button
Switches from viewfinder display to Live View display. Recording is possible when the power switch is set to <🔋>.
- (16) <Av📷> (Aperture/Exposure compensation) button
- (17) <📷> (AF point selection)/<🔍> (Magnify) button
- (18) <🔒> (AE lock/FE lock)/<📷-🔍> (Index/Reduce) button
- (19) <Q> (Quick Control)/<SET> (Setting) button
Displays the Quick Control screen. Also used to confirm selected settings.
- (20) <▲><▼><◀><▶>: <⬢> Cross keys
- (21) Access lamp
- (22) <🗑️> (Single-image erase) button
- (23) <▶> (Playback) button

Mode Dial

The Mode Dial includes the Basic Zone modes and Creative Zone modes.

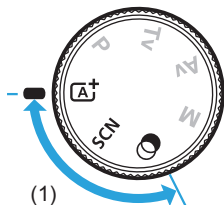













(1) Basic Zone











All you do is press the shutter button. The camera sets everything to suit the subject or scene for shooting.

A⁺ : Scene Intelligent Auto (📖70)

SCN : Special scene (📖78)

 Portrait (📖79)	 Close-up (📖85)
 Smooth skin (📖80)	 Food (📖86)
 Group Photo (📖81)	 Candlelight (📖87)
 Landscape (📖82)	 Night Portrait (📖88)
 Sports (📖83)	 Handheld Night Scene (📖89)
 Kids (📖84)	 HDR Backlight Control (📖90)

 : Creative filters (📖93)

 Grainy B/W (📖95)	 Miniature effect (📖96)
 Soft focus (📖95)	 HDR art standard (📖96)
 Fish-eye effect (📖95)	 HDR art vivid (📖96)
 Water painting effect (📖95)	 HDR art bold (📖96)
 Toy camera effect (📖95)	 HDR art embossed (📖96)

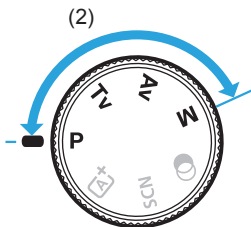

(2) Creative Zone

These modes give you more control for shooting various subjects as desired.

P : Program AE (📖 147)

Tv : Shutter-priority AE (📖 149)

Av : Aperture-priority AE (📖 152)

M : Manual exposure (📖 155)

Viewfinder Information Display

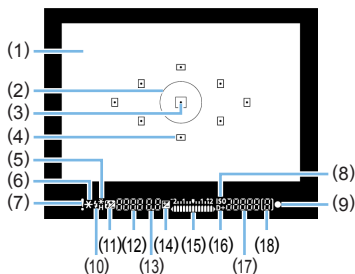

- | | |
|-----------------------------------|-----------------------------------|
| (1) Focusing screen | (12) Shutter speed |
| (2) Spot metering circle | Bulb exposure (buLb) |
| (3) AF point activation indicator | FE lock (FEL) |
| (4) AF point | Busy (buSy) |
| (5) High-speed sync | Built-in flash recharging |
| FE lock / FEB in-progress | (buSy) |
| (6) AE lock / AEB in-progress | No card warning (Card) |
| (7) Warning icon | Card error (Card) |
| | Card full warning (FuLL) |
| | Error code (Err) |
| (8) ISO speed indicator | (13) Aperture |
| (9) Focus indicator | (14) Exposure compensation |
| (10) Flash-ready | (15) Exposure level indicator |
| Improper FE lock warning | Exposure compensation amount |
| (11) Flash exposure compensation | AEB range |
| | (16) Highlight tone priority |
| | (17) ISO speed |
| | (18) Maximum burst |

- The display will show only the settings currently applied.

Battery Charger LC-E17

Charger for Battery Pack LP-E17 (📖35).

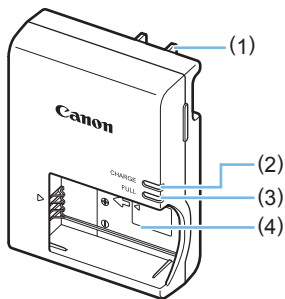

- (1) Power plug
- (2) Charge lamp
- (3) Full-charge lamp
- (4) Battery pack slot

Getting Started and Basic Camera Operations

This chapter describes preparatory steps before you start shooting and the basic camera operations.

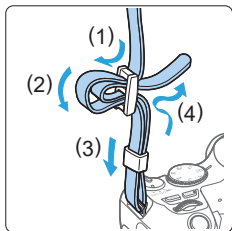

Attaching the Provided Strap

Pass the end of the strap through the camera's strap mount eyelet from the bottom. Then pass it through the strap's buckle as shown in the illustration. Pull the strap to take up any slack and make sure the strap will not loosen from the buckle.

Charging the Battery

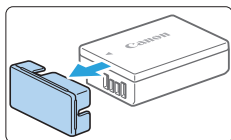

- 1 Remove the protective cover.**
 - Detach the protective cover provided with the battery.

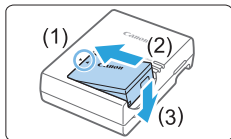

- 2 Attach the battery.**
 - As shown in the illustration, attach the battery securely to the charger.
 - To detach the battery, follow the above procedure in reverse.

LC-E17

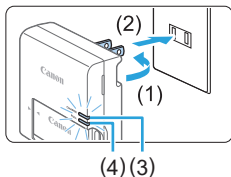

- 3 Recharge the battery.**

For LC-E17

- As shown by the arrow, flip out the battery charger's prongs (1) and insert the prongs into a power outlet (2).

For LC-E17E

- Connect the power cord to the charger and insert the plug into a power outlet.
- ➔ Recharging starts automatically and the charge lamp (3) lights up in orange.
- ➔ When the battery is fully recharged, the full-charge lamp (4) will light up in green.

LC-E17E

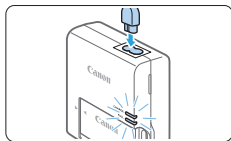

- It takes approx. 2 hours to fully recharge a completely exhausted battery at room temperature (23°C / 73°F). The time required to recharge the battery will vary greatly depending on the ambient temperature and the battery's remaining capacity.
- For safety reasons, recharging in low temperatures (5°C - 10°C / 41°F - 50°F) will take longer (up to approx. 4 hr.).



Tips for Using the Battery and Charger

- **Upon purchase, the battery is not fully charged.**
Charge the battery before use.
- **Recharge the battery on the day before or on the day it is to be used.**
Even during storage, a charged battery will gradually drain and lose its capacity.
- **After recharging the battery, detach it and disconnect the charger from the power outlet.**
- **When not using the camera, remove the battery.**
If the battery is left in the camera for a prolonged period, a small amount of power current will keep being released, resulting in excess discharge and shorter battery life. Store the battery with the protective cover (provided) attached. Storing the battery when it is fully charged may lower the battery performance.
- **The battery charger can also be used in foreign countries.**
The battery charger is compatible with a 100 V AC to 240 V AC 50/60 Hz power source. If necessary, attach a commercially-available plug adapter for the respective country or region. Do not attach any portable voltage transformer to the battery charger. Doing so may damage the battery charger.
- **If the battery becomes exhausted quickly even after having been fully charged, the battery has reached the end of its service life.**
Check the battery's recharge performance (📖460) and purchase a new battery.



- After disconnecting the charger's power plug, do not touch the prongs for approx. 5 sec.
- Do not charge any battery other than a Battery Pack LP-E17.
- Battery Pack LP-E17 is dedicated to Canon products only. Using it with an incompatible battery charger or product may result in malfunction or accidents for which Canon cannot be held liable.

Installing and Removing the Battery and Card

Load a fully charged Battery Pack LP-E17 into the camera. The camera can use an SD, SDHC, or SDXC memory card (sold separately). UHS-I Speed Class SDHC and SDXC memory cards can also be used. The captured images are recorded onto the card.



- Make sure the card's write-protect switch is set upward to enable writing/erasing.

Installing the Battery and Card

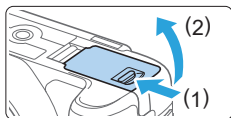

1 Open the cover.

- Slide the lever as shown by the arrows and open the cover.

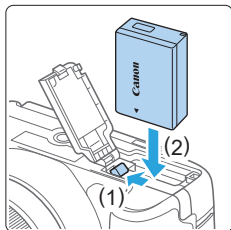

2 Insert the battery.

- Insert the end with the battery contacts.
- Insert the battery until it locks in place.

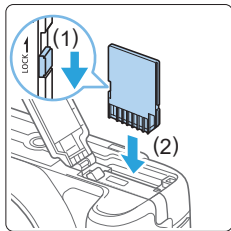

3 Insert the card.

- As shown by the illustration, face the card's label side toward the back of the camera and insert it until it clicks in place.

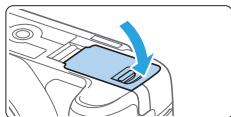

4 Close the cover.

- Press the cover until it snaps shut.
- When you set the power switch to <ON>, the number of possible shots will be displayed on the LCD monitor.



- After opening the card slot/battery compartment cover, be careful not to swing it back any further. Otherwise, the hinge may break.



- The number of possible shots varies depending on the remaining capacity of the card, image-recording quality, ISO speed, etc.
- Setting [📷: Release shutter without card] to [Disable] will prevent you from forgetting to insert a card before shooting (📖260).

Removing the Battery and Card

1 Set the power switch to <OFF> (📖41).

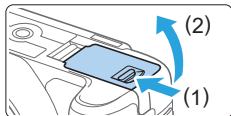

2 Open the cover.

- Make sure the access lamp is off, then open the cover.
- If [Saving...] is displayed, close the cover.

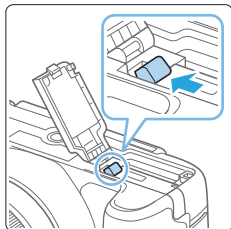

3 Remove the battery.

- Press the battery lock lever as shown by the arrow and remove the battery.
- To prevent short-circuiting, be sure to attach the provided protective cover (📖35) to the battery.

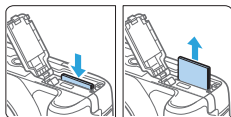

4 Remove the card.

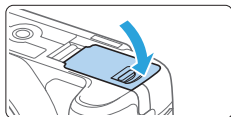

- Gently push in the card, then let go to eject it.
- Pull the card straight out.



5 Close the cover.

- Press the cover until it snaps shut.



- **When the access lamp is lit or blinking, it indicates that images are being written to, read from, or erased from the card, or data is being transferred. Do not open the card slot/battery compartment cover. Also, never do any of the following while the access lamp is lit or blinking. Otherwise, it can damage the image data, card, or camera.**
 - **Removing the card.**
 - **Removing the battery.**
 - **Shaking or banging the camera around.**
 - **Unplugging and connecting a power cord** (when household power outlet accessories (sold separately,  461) are used).
- If the card already contains recorded images, the image file number may not start from 0001 ( 265).
- If a card-related error message is displayed on the LCD monitor, remove and reinsert the card. If the error persists, use a different card.
If you can transfer images on the card to a computer, transfer all the images and then format the card with the camera ( 66). The card may then return to normal.
- Do not touch the card's contacts with your fingers or metal objects. Do not expose the contacts to dust or water. If smudges adhere to the contacts, contact failure may result.
- Multimedia cards (MMC) cannot be used. (Card error will be displayed.)

Using the LCD Monitor

After you flip out the LCD monitor, you can set menu functions, use Live View shooting, shoot movies, or play back photos and movies. You can change the direction and angle of the LCD monitor.

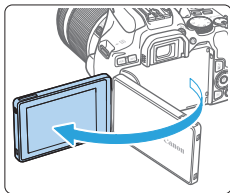

1 Flip out the LCD monitor.

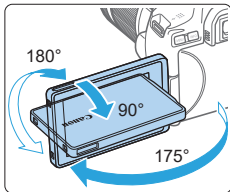

2 Rotate the LCD monitor.

- When the LCD monitor is swung out, you can rotate it up, down, or over 180° to face the subject.
- The indicated angle is only approximate.

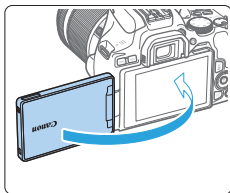

3 Face it toward you.

- Normally, use the camera with the LCD monitor facing you.



- Be careful not to forcefully rotate the LCD monitor, putting much power on the rotating axis (hinge).
- When a cable is connected to a camera terminal, the rotation angle range of the flipped out LCD monitor will be limited.



- When not using the camera, close the LCD monitor with the screen facing inward. You can protect the screen.
- During Live View shooting or movie shooting, facing the LCD monitor toward the subject will display a mirror image on the screen (right/left reversed).

Turning on the Power

If you turn on the power switch and the date/time/zone setting screen appears, see page 43 to set the date/time/zone.

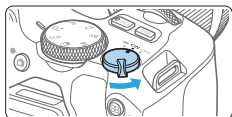

- <CAM> :The camera turns on. You can shoot movies (📖218).
- <ON> :The camera turns on. You can shoot still photos.
- <OFF> :The camera is turned off and does not function. Set the power switch to this position when not using the camera.

Automatic Sensor Cleaning

- Whenever you set the power switch to <ON> or <OFF>, sensor cleaning will be performed automatically. (A small sound may be heard.) During the sensor cleaning, the LCD monitor will display <🧹>.
- Even during the sensor cleaning, if you press the shutter button halfway (📖50), cleaning operation will be stopped, and you can take a picture immediately.
- If you repeatedly turn the power switch <ON> and <OFF> at a short interval, the <🧹> icon may not be displayed. This is normal and not a malfunction.

Auto Power Off

To save battery power, if the camera is not operated for a prolonged period, the power will turn off automatically after the time set under [**🔋: Auto power off**] (📖261). To turn on the camera again, just press the shutter button halfway (📖50).







- If you set the power switch to <OFF> while an image is being recorded to the card, [**Saving...**] will be displayed and the power will turn off after the recording finishes.

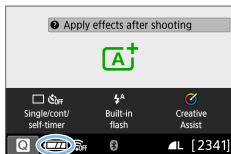

Battery Level Indicator

When the power is turned on, the battery level will be indicated in one of the four levels.



- : Battery level is sufficient.
- : Battery level is low, but the camera can still be used.
- : Battery will be exhausted soon. (Blinks)
- : Recharge the battery.



- Doing any of the following will exhaust the battery faster:
 - Pressing the shutter button halfway for a prolonged period.
 - Activating the AF frequently without taking a picture.
 - Using the lens's Image Stabilizer.
 - Using the LCD monitor frequently.
 - Using the Wi-Fi function or Bluetooth function.
- The number of possible shots may decrease depending on the actual shooting conditions.
- The lens operation is powered by the camera's battery. Certain lenses may exhaust the battery faster than others.
- See [ **Battery info.**] to check the battery condition ( 460).

Setting the Date, Time, and Time Zone

When you turn on the power for the first time or if the date/time/zone have been reset, the date/time/zone setting screen will appear. Follow the steps below to set the time zone first. Set the camera to the time zone in which you currently live so that, when you travel, you can simply change the setting to the correct time zone for your destination, and the camera will automatically adjust the date/time.

Note that the date/time appended to recorded images will be based on this date/time setting. Be sure to set the correct date/time.

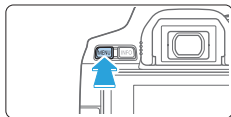

1 Display the main tabs.

- Press the <MENU> button to display the main tabs.

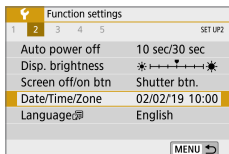

2 Under the [☛] tab, select [Date/Time/Zone].

- Press the <◀> <▶> keys to select the [☛] main tab, then press <SET>.
- Press the <◀> <▶> keys to select a secondary tab.
- Press the <▲> <▼> keys to select [Date/Time/Zone], then press <SET>.

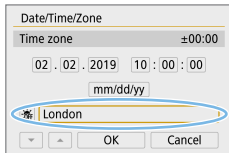

3 Set the time zone.

- [London] is set by default.
- Press the <◀> <▶> keys to select [Time zone], then press <SET>.



- For the menu function setting procedures, see 59 - 62.
- In step 3, the time displayed in **[Time zone]** is the time difference compared to Coordinated Universal Time (UTC).

Zone/Time difference

02/02/2019 10:00:00

Zone

London

Time zone

02/02/2019 10:00:00

São Paulo -03:00

Fernando de Noronha -02:00

Azores -01:00

London ±00:00

Paris +01:00

SET OK

Zone/Time difference

02/02/2019 10:00:00

Zone

Time difference + 09 : 15

OK Cancel

Date/Time/Zone

(02/02/2019)

02 . 02 . 2019 10 : 00 : 00

mm/dd/yy

London

OK Cancel

- Press <SET> again.
- Press the <▲> <▼> keys to select the time zone, then press <SET>.
- If your desired time zone is not listed, press the <MENU> button, then proceed to the next step to set it (with the time difference from the Coordinated Universal Time, UTC).
- To set the time difference from UTC, press the <◀> <▶> keys to select a parameter (+/-/hour/minute) for **[Time difference]**.
- Press <SET> so <☐> is displayed.
- Press the <▲> <▼> keys to set it, then press <SET>. (Returns to <☐>.)
- After entering the time zone or time difference, use the <◀> <▶> keys to select **[OK]**, then press <SET>.

4 Set the date and time.

- Press the <◀> <▶> keys to select the number.
- Press <SET> so <☐> is displayed.
- Press the <▲> <▼> keys to set it, then press <SET>. (Returns to <☐>.)

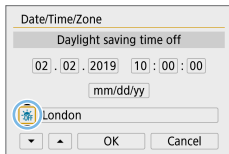

5 Set the daylight saving time.

- Set it as necessary.
- Press the <◀> <▶> keys to select [☀].
- Press <SET> so <☀> is displayed.
- Press the <▲> <▼> keys to select [☀], then press <SET>.
- When the daylight saving time is set to [☀], the time set in step 4 will advance by 1 hour. If [☀] is set, the daylight saving time will be canceled and the time will go back by 1 hour.

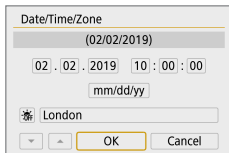

6 Exit the setting.

- Press the <◀> <▶> keys to select [OK], then press <SET>.
- ➔ The date/time/zone and daylight saving time will be set and the menu will reappear.



- The date/time/zone settings may be reset in the following cases. If this happens, set the date/time/zone again.
 - When the camera is stored without the battery.
 - When the camera's battery becomes exhausted.
 - When the camera is exposed to below freezing temperatures for a prolonged period.



- The set time and date will start from when you select [OK] in step 6.
- Even if [☿ : Auto power off] is set to [4 min.] or less, the auto power off time will be approx. 6 min. when the [☿ : Date/Time/Zone] setting screen is displayed.
- After changing the time zone or time difference setting, check that the correct date and time are set.

Selecting the Interface Language

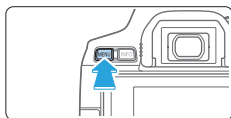

1 Display the main tabs.

- Press the <MENU> button to display the main tabs.

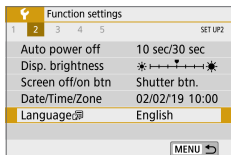

2 Under the [Language] tab, select [Language].

- Press the <◀> <▶> keys to select the [Language] main tab, then press <SET>.
- Press the <◀> <▶> keys to select a secondary tab.
- Press the <▲> <▼> keys to select [Language], then press <SET>.



3 Set the desired language.

- Press the <⬆> cross keys to select the language, then press <SET>.
- ➔ The interface language will change.

Attaching and Detaching a Lens

The camera is compatible with all Canon EF and EF-S lenses. Note that you cannot use RF or EF-M lenses.

Attaching a Lens

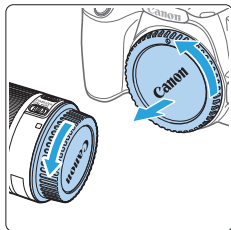

1 Remove the caps.

- Remove the rear lens cap and the body cap by turning them as shown by the arrows.

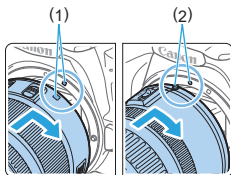

2 Attach the lens.

- Align the lens's red or white index with the camera's index matching the same color. Turn the lens as shown by the arrow until it clicks in place.

- (1) White index
(2) Red index

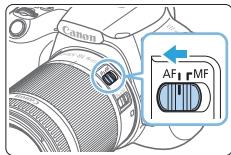

3 Set the lens focus mode switch to <AF>.

- <AF> stands for autofocus.
- <MF> stands for manual focus.

4 Remove the front lens cap.

Tips for Avoiding Smudges and Dust

- When changing lenses, do it quickly in a place with minimal dust.
- When storing the camera without a lens attached, be sure to attach the body cap to the camera.
- Remove dust on the body cap before attaching it.

Zooming

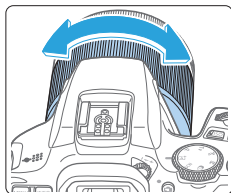

Turn the zoom ring on the lens with your fingers.

- Perform the zoom operation before focusing. Turning the zoom ring after achieving focus may throw off the focus.

Detaching the Lens

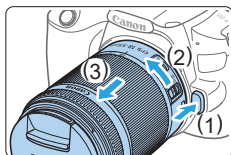

While pressing the lens release button, turn the lens as shown by the arrow.

- Turn the lens until it stops, then detach it.
- Attach the rear lens cap to the detached lens.



- Do not look at the sun directly through any lens. Doing so may cause loss of vision.
- **When attaching or detaching a lens, set the camera's power switch to <OFF>.**
- If the front part (focusing ring) of the lens rotates during autofocus, do not touch the rotating part.



● Angle of View

- Since the image area is smaller than the 35mm film format, the effective angle of view of an attached lens will be equivalent to that of a lens with approx. 1.6x of the focal length indicated.

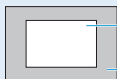

Image area (Approx.) (22.3 x 14.9 mm / 0.88 x 0.59 in.)

35mm film format (36 x 24 mm / 1.42 x 0.94 in.)

- For instructions on how to use the lens, refer to the Lens Instruction Manual.

Basic Shooting Operations

Adjusting the Viewfinder Clarity

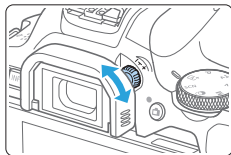

Turn the dioptic adjustment knob.

- Turn the knob left or right so that the AF points in the viewfinder look sharp.
- If the knob is difficult to turn, remove the eyecup (📖464).



- If the camera's dioptic adjustment still cannot provide a sharp viewfinder image, using E-series Dioptic Adjustment Lenses (sold separately) is recommended.

Holding the Camera

To obtain sharp images, hold the camera still to minimize camera shake.

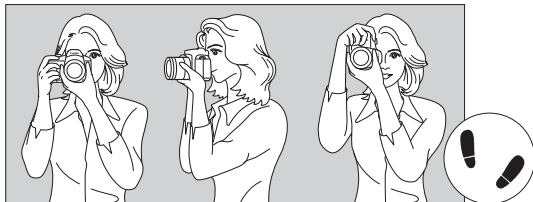

Horizontal shooting

Vertical shooting

- (1) Wrap your right hand around the camera grip firmly.
- (2) Hold the lens bottom with your left hand.
- (3) Rest your right index finger lightly on the shutter button.
- (4) Press your arms and elbows lightly against the front of your body.
- (5) To maintain a stable stance, place one foot slightly ahead of the other.
- (6) Press the camera against your face and look through the viewfinder.



- To shoot while looking at the LCD monitor, see page 180.

Shutter Button

The shutter button has two steps. You can press the shutter button halfway. Then you can further press the shutter button completely.

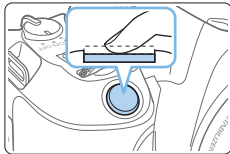

Pressing Halfway

This activates autofocus and the automatic exposure system that sets the shutter speed and aperture.

The exposure setting (shutter speed and aperture) is displayed in the viewfinder. While you press the shutter button halfway, the LCD monitor will turn off (📖272).

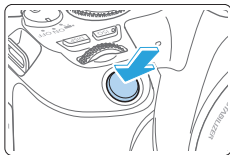

Pressing Completely

This releases the shutter and takes the picture.

Preventing Camera Shake

Hand-held camera movement during the moment of exposure is called camera shake. It can cause blurred pictures. To prevent camera shake, note the following:

- Hold and steady the camera as shown on “Holding the Camera” (📖49).
- Press the shutter button halfway to autofocus, then slowly press the shutter button completely.



- If you press the shutter button completely without pressing it halfway first, or if you press the shutter button halfway and then press it completely immediately, the camera will take a moment before it takes the picture.
- Even during menu display, image playback, or image recording, you can immediately go back to shooting-ready state by pressing the shutter button halfway.

Setting the Screen Display Level

You can set how information is displayed on the screen according to your preference. Change the settings as necessary.

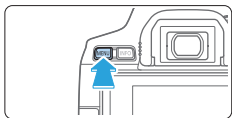

1 Display the main tabs.

- Press the <MENU> button to display the main tabs.

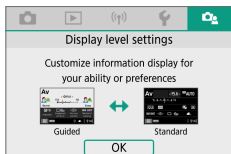

2 Select the [📷] tab.

- Press the <◀> <▶> keys of the cross keys to select the [📷] tab, then press <SET>.

Shooting Screen

You can select **[Standard]** or **[Guided]** (friendly display) for the Quick Control screen in viewfinder shooting. By default, it is set to **[Guided]**.

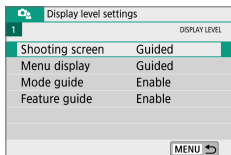

1 Select [Shooting screen].

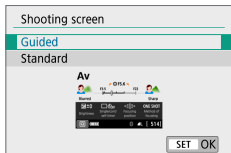

2 Select the display method.

• Sample Screens

<📷>: Guided

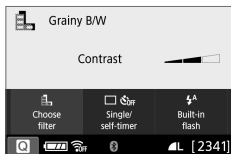

<📷>: Standard

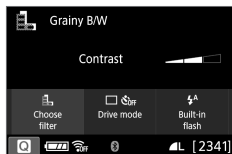

<Av>: Guided

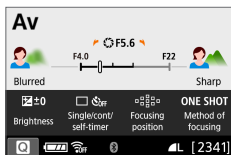

<Av>: Standard



- In Creative Zone modes, when **[Guided]** is set, only the functions particular to the set shooting mode are displayed on the Quick Control screen. Note that items that cannot be set from the Quick Control screen when **[Guided]** is selected can be set via the menu screen (📖60).

Menu Display

You can select the display type from **[Standard]** or **[Guided]**. If you set **[Guided]**, main tab descriptions are provided when you press the <MENU> button. If you set **[Standard]**, you proceed directly to the menu screen when you press the <MENU> button. By default, it is set to **[Guided]**.

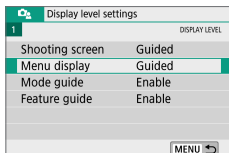

1 Select **[Menu display]**.

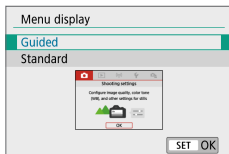

2 Select the display type.

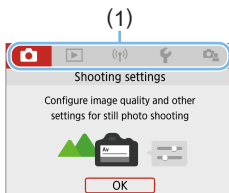

(1) Main tabs



- When **[Guided]** is set, the **[★ (My Menu)]** tab does not appear. To set My Menu (455), change the menu display level to **[Standard]**.

Shooting Mode Guide

A brief description of the shooting mode can be displayed when you switch shooting modes. By default, it is set to **[Enable]**.

Display level settings	
1 DISPLAY LEVEL	
Shooting screen	Guided
Menu display	Guided
Mode guide	Enable
Feature guide	Enable

1 Select **[Mode guide]**.

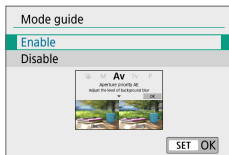

2 Select **[Enable]**.

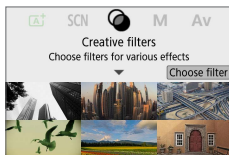

3 Turn the **Mode Dial**.

→ A description of the selected shooting mode will appear.



4 Press the **<▼>** key.

- The rest of the description will appear.
- To clear the mode guide, press **<SET>**.
- In the **<SCN>** and **<M>** shooting modes, the shooting mode selection screen will appear.

Feature Guide

When using Quick Control or setting menu items, you can display a brief description of functions and options (feature guide). By default, it is set to **[Enable]**.

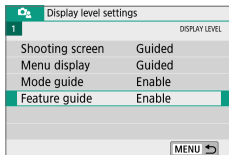

1 Select **[Feature guide]**.

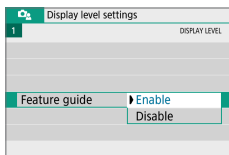

2 Select **[Enable]**.

● Sample Screens

Quick Control screen

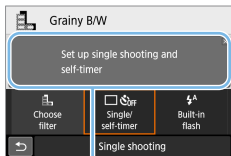

(1)

Menu screen

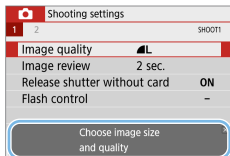

(1)

(1) Feature guide



- The description will disappear when you tap on it or proceed with the operation.



Shooting Tips

Shooting tips appear when **[Shooting screen]** is set to **[Guided]** (📖51) and the camera settings result in any of the following conditions. In Basic Zone modes, shooting tips appear regardless of the **[Shooting screen]** setting.

- You want to blur the background further (by setting the lowest aperture value in the **<Av>** mode).
- The image is likely to be overexposed.
- The image is likely to be underexposed.
- Camera shake is likely to occur (only in Basic Zone modes).

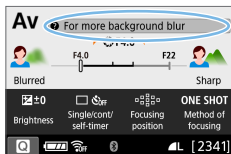

1 Tap on the area within the frame.

- ➔ The shooting tips will appear.
- You can also display the shooting tips by pressing the **<🗑>** button.

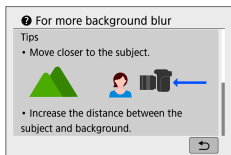

2 Check the shooting tips.

- You can scroll up and down by tapping on the screen.
- You can also scroll by pressing the **<▲>** **<▼>** keys.

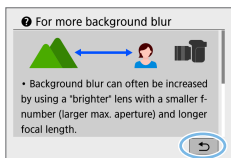

3 Tap on [↶].

- ➔ Shooting tips will disappear, and the screen in step 1 will reappear.
- You can also hide the shooting tips by pressing **<SET>**.

Quick Control for Shooting Functions

You can directly select and set the shooting functions displayed on the LCD monitor with intuitive operations. This is called Quick Control.

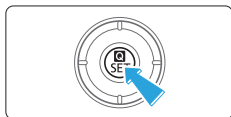

1 Press the <Q> button.

→ The Quick Control screen will appear.



2 Set the desired functions.

- Press the <⬆> cross keys to select a function.
- The settings of the selected function and Feature guide (📖55) will appear.
- Turn the <🌀> dial to change the setting.

Basic Zone modes

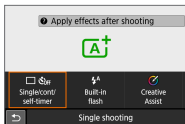
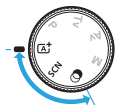

Creative Zone modes

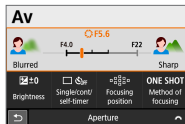
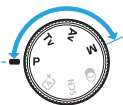

3 Take the picture.

- Press the shutter button completely to take the picture.
- The captured image will be displayed.



- In steps 1 and 2, you can also tap on the LCD monitor to perform the operation (📖63).

Sample Quick Control Screen

● When [Qc] : Shooting screen: Guided] is Set

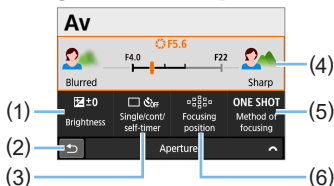

- | | |
|---------------------------|------------------------|
| (1) Exposure compensation | (4) Aperture |
| (2) Return | (5) AF operation |
| (3) Drive mode | (6) AF point selection |

● When [Qc] : Shooting screen: Standard] is Set

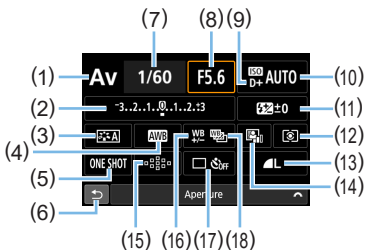

- | | |
|---------------------------------------|----------------------------------|
| (1) Shooting mode* | (10) ISO speed |
| (2) Exposure compensation/AEB setting | (11) Flash exposure compensation |
| (3) Picture Style | (12) Metering mode |
| (4) White balance | (13) Image-recording quality |
| (5) AF operation | (14) Auto Lighting Optimizer |
| (6) Return | (15) AF point selection |
| (7) Shutter speed | (16) White balance correction |
| (8) Aperture | (17) Drive mode |
| (9) Highlight tone priority* | (18) White balance bracketing |

* These functions cannot be set with Quick Control.

Menu Operations and Configurations

You can configure various settings with the menus such as the image-recording quality, date/time, etc.

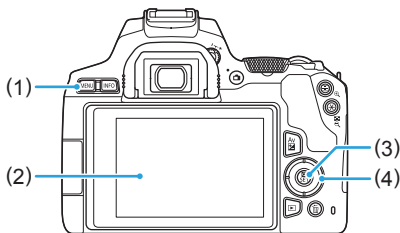

(1) <MENU> button

(2) LCD monitor

(3) <SET> button

(4) <+> cross keys

Menu Screen

The menu tabs and items displayed vary depending on the shooting mode.

Basic Zone modes

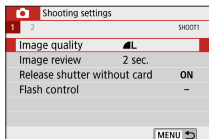
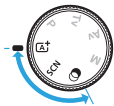

Movie shooting

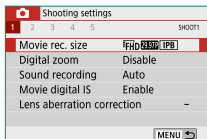

Creative Zone modes

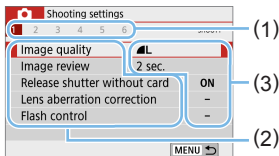

(1) Secondary tabs

(2) Menu items

(3) Menu settings

Menu Setting Procedure

- When [MENU: Menu display: Guided] is Set

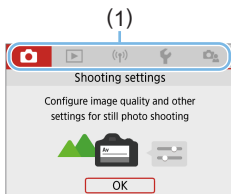

1 Display the main tabs.

- When you press the <MENU> button, the main tabs (1) and a description of the selected tab will appear.

2 Select a main tab.

- Each time you press the <<<>>> keys of the cross keys, the main tab (group of functions) will switch.

3 Display the menu screen.

- Press <SET> to display the menu screen.
- To return to the main tab screen, press the <MENU> button.

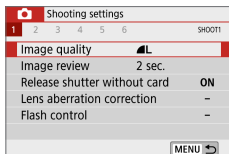

4 Select a secondary tab.

- Press the <<<>>> keys of the cross keys to select a secondary tab.

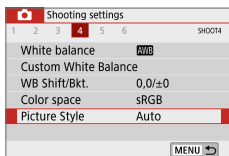

5 Select the desired item.

- Press the <▲><▼> keys of the cross keys to select the item, then press <SET>.

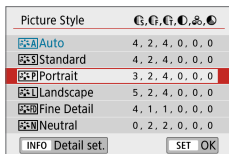

6 Select the setting.

- Press the <▲><▼> or <<<>>> keys of the cross keys to select the desired setting. (Some settings are selected with the <▲><▼> keys, and others are selected with the <<<>>> keys.)
- The current setting is indicated in blue.

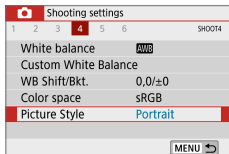

7 Set the setting.

- Press <SET> to set it.
- ➔ If you change the setting from the default, it will be indicated in blue (available only for the menu items under the [📷] tab).

8 Exit the setting.

- Press the <MENU> button twice to exit the menu and return to shooting-ready state.



- In step 2, you can also use the <🌓> dial and <INFO> button, instead of the cross keys.
- You can also go to the menu screen by tapping on [OK] in step 3.
- In steps 2 to 8, you can also tap on the LCD monitor to perform the operation (📖63).
- The description of menu functions hereafter assumes that the menu screen is displayed.
- To cancel the operation, press the <MENU> button.

● When [📷 : Menu display: Standard] is Set

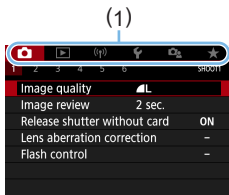

1 Display the menu screen.

- Press the <MENU> button to display the menu screen.

2 Select a tab.

- Press the <◀> <▶> keys to select the main tab (1) and secondary tab.
- The subsequent operations are the same as those for [📷 : Menu display: Guided]. See the steps on “Menu Setting Procedure” (📖60), starting with step 5.
- To exit the setting, press the <MENU> button once.



- In step 2, you can also use the <🌓> dial and <INFO> button, instead of the cross keys. Note that the <INFO> button cannot be used on secondary tabs.

Dimmed Menu Items

Example: When [Multi Shot Noise Reduction] is set

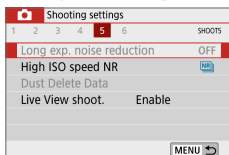

Dimmed menu items cannot be set. The menu item is dimmed if another function setting is overriding it.

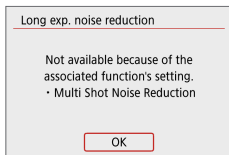

You can see the overriding function by selecting the dimmed menu item and pressing <SET>.

If you cancel the overriding function's setting, the dimmed menu item will become settable.



- You may not be able to see the overriding function for certain dimmed menu items.



- With [Clear all camera settings] under [F: Clear settings], you can reset the menu functions to the default settings (📖271).

Operating the Camera with Touch Screen

You can operate the camera by tapping on the LCD monitor (touch-sensitive panel) with your fingers.

Tap

Sample Screen (Quick Control)

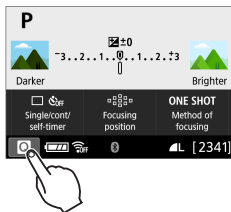

- Use your finger to tap on (touch briefly and then remove your finger from) the LCD monitor.
- By tapping, you can select menus, icons, etc. displayed on the LCD monitor.
- For example, when you tap on [Q], the Quick Control screen appears. By tapping on [↶], you can return to the preceding screen.

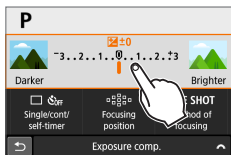

Operations possible by tapping on the screen

- Setting menu functions after pressing the <MENU> button
- Quick Control
- Setting functions after pressing the <ISO> or <[ISO]> button
- Touch AF and Touch Shutter in Live View shooting
- Selecting AF points
- Setting functions in Live View shooting and movie shooting
- Playback operations



- If [Beep] is set to [Touch Off], the beep will not sound for touch operations (p.260).

Drag

Sample Screen (Menu screen)

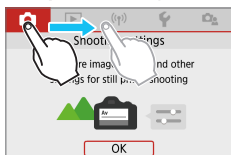

- Slide your finger while touching the LCD monitor.

Sample Screen (Scale display)

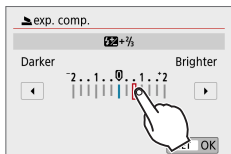

Operations possible by dragging your finger on the screen

- Selecting a menu tab or item after pressing the <MENU> button
- Setting with scale display
- Quick Control
- Selecting AF points
- Setting functions in Live View shooting and movie shooting
- Playback operations

Setting the Touch Control Response

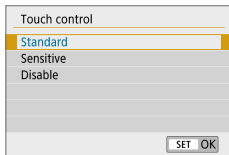
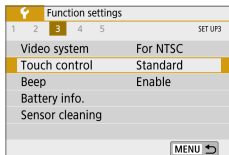

1 Select [Touch control].

- Under the [**f**] tab, select [Touch control], then press <SET>.

2 Set the touch control response setting.

- Select the desired setting, then press <SET>.
- [Standard] is the normal setting.
- [Sensitive] provides a more reactive touch screen response than [Standard]. Try using both settings and select the one you prefer.
- To disable touch operations, select [Disable].



Cautions for Touch Control Operations

- Since the LCD monitor is not pressure sensitive, do not use any sharp objects, such as your fingernail or a ballpoint pen, for touch operations.
- Do not use wet fingers for touch operations.
- If the LCD monitor has any moisture or if your fingers are wet, the touch screen may not respond or malfunction may occur. In such a case, turn off the power and wipe off the moisture with a cloth.
- Attaching any commercially-available protective sheet or sticker on the LCD monitor may degrade the touch operation response.
- If you quickly perform touch operation when [Sensitive] is set, the touch operation response may be poor.

Formatting Memory Cards

If the card is new or was previously formatted by another camera or computer, format the card with this camera.



- When the card is formatted, all images and data on the card will be erased. Even protected images will be erased, so make sure there is nothing you need to keep. If necessary, transfer the images and data to a computer, etc. before formatting the card.

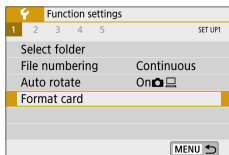

1 Select [Format card].

- Under the [**F**] tab, select [**Format card**], then press <SET>.

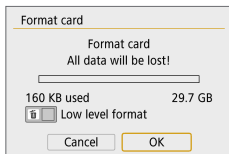

2 Format the card.

- Select [**OK**], then press <SET>.
- ➔ The card will be formatted.
- ➔ When the formatting is complete, the menu will reappear.
- For low-level formatting, press the <🗑️> button to add a checkmark <✓> to [**Low level format**], then select [**OK**].

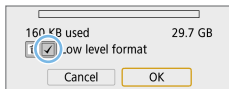

- The card capacity displayed on the card format screen may be smaller than the capacity indicated on the card.
- This device incorporates exFAT technology licensed from Microsoft.



Perform [Format card] in the following cases:

- The card is new.
- The card was formatted by a different camera or a computer.
- The card is full of images or data.
- A card-related error is displayed (📖 477).

Low-level Formatting

- Perform low-level formatting if the card's writing or reading speed seems slow or if you want to totally erase the data on the card.
- Since low-level formatting will format all recordable sectors on the card, the formatting will take slightly longer than normal formatting.
- You can stop the low-level formatting by selecting [**Cancel**]. Even in this case, normal formatting will already be complete and you can use the card as usual.

● Card's file formats

SD/SDHC cards will be formatted in FAT32. SDXC cards will be formatted in exFAT.

When shooting a movie with a card formatted in exFAT, the movie will be recorded in a single file (instead of being split into multiple files) even if it exceeds 4 GB. (The movie file will exceed 4 GB.)



- If you format an SDXC card with this camera and then insert it into another camera, an error may be displayed and the card may become unusable. Certain computer operating systems or card readers may not recognize a card formatted in exFAT.
- When the card is formatted or data is erased, only the file management information is changed. The actual data is not completely erased. Be aware of this when selling or discarding the card. When discarding the card, perform low-level formatting or destroy the card physically to prevent personal data from being leaked.

Switching the LCD Monitor Display

The LCD monitor can display the Quick Control screen, menu screen, captured images, etc.

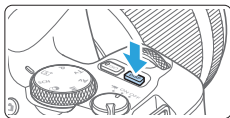
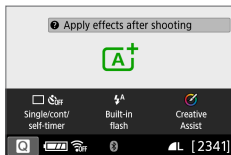

- When you turn on the power, the Quick Control screen will appear. You can then check the current shooting function settings.
- **When you press the shutter button halfway, the display will turn off. And when you let go of the shutter button, the display will turn on.**
- You can also turn off the display by pressing the <DISP> button. Press the button again to turn on the display.

Menu Functions

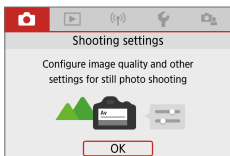

- Appears when you press the <MENU> button. Press the button again to return to the previous screen.

Captured Image



- Appears when you press the <▶> button. Press the button again to return to the previous screen.



- You can set [**⚡**: **Screen off/on btn**] so that the LCD monitor does not turn off or on (272).
- Even when the menu screen or captured image is displayed, pressing the shutter button will enable you to shoot immediately.
- You can also turn off the display by pressing the <INFO> button. Press the button again to turn on the display.

Basic Shooting and Image Playback

This chapter describes how to use the Basic Zone modes on the Mode Dial for best results and how to play back images. With Basic Zone modes, all you do is point and shoot, and the camera sets everything automatically. Also, because advanced shooting function settings cannot be changed, you can enjoy shooting photographs without worrying about botched pictures due to misoperation.

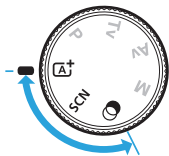
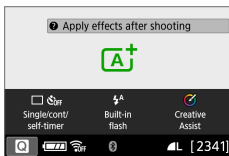

- **Before Shooting in the <SCN> or <Q> Mode**

When the LCD monitor is turned off, press the <Q> button (78, 93) to check which shooting mode is set, then start shooting.

- * <SCN>: Special scene
- * <Q>: Creative filters

Fully Automatic Shooting (Scene Intelligent Auto)

<A⁺> is a fully automatic mode. The camera analyzes the scene and sets the optimum settings automatically. It can also adjust focus automatically on either the still or moving subject by detecting the motion of the subject (📖74).

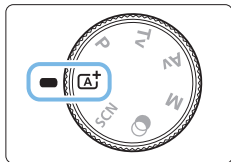

1 Set the Mode Dial to <A⁺>.



2 Aim the AF point over the subject.

- All the AF points (1) will be used to focus, and the camera will normally focus on the closest object.
- Aiming the center of the AF point over the subject will make focusing easier.

(1)

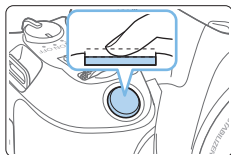

(1)

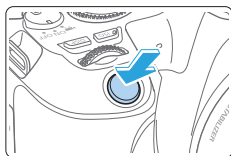

3 Focus on the subject.

- Press the shutter button halfway. The lens elements will shift to focus.
- ➔ When achieving focus, the dot inside the AF point achieving focus flashes briefly in red. At the same time, the beeper will sound and the focus indicator <●> (1) in the viewfinder will light up.
- If necessary, lift the flash with your fingers.

4 Take the picture.

- Press the shutter button completely to take the picture.
- ➔ The captured image will be displayed for approx. 2 sec. on the LCD monitor.
- When you finish shooting, push down the built-in flash with your fingers.



- Before raising the flash, remove any accessories attached to the hot shoe.



- If a description of the shooting mode appears in step 1, press <SET> to hide it (📖 54).
- The <A+> mode makes the colors look more impressive in nature, outdoor, and sunset scenes. If you do not obtain the desired color tones, change the mode to a Creative Zone mode and select a Picture Style other than <P-A>, then shoot again (📖 121).

? FAQ

- **The focus indicator <●> blinks and focus is not achieved.**
 - Aim the AF point over an area with good contrast, then press the shutter button halfway (📖50).
 - If you are too close to the subject, move away and shoot again.
 - Select the AF point nearest to where you want to focus (📖108).
The default setting is Automatic selection AF.
- **Multiple AF points light up simultaneously.**

Focus has been achieved at all those points that flash in red. You can take the picture as long as an AF point covering the target subject is lighting up.
- **The beeper continues to beep softly. (The focus indicator <●> does not light up.)**

It indicates that the camera is focusing continuously on a moving subject. (The focus indicator <●> does not light up.) You can take sharp pictures of a moving subject.
Note that focus lock (📖74) is not possible in this case.
- **Pressing the shutter button halfway does not focus on the subject.**

If the focus mode switch of the lens is set to <MF> (manual focus), set it to <AF> (autofocus).
- **The flash fired even if it was daylight.**

For a backlit subject, the flash may fire to help lighten the subject's dark areas. To prevent the built-in flash from firing, push it down with your fingers.
- **The built-in flash fired and the picture came out extremely bright.**

Move further away from the subject and shoot. When shooting with flash, if the subject is too close to the camera, the picture may come out extremely bright (overexposure).
- **In low light, the built-in flash fired a series of flashes.**

Pressing the shutter button halfway may trigger the built-in flash to fire a series of flashes to assist autofocusing. This is called the AF-assist beam. Its effective range is approx. 4 meters/13.1 feet. Note that the built-in flash will make a sound when firing continuously. This is normal and not a malfunction.

- **When flash was used, the bottom part of the picture came out unnaturally dark.**

The shadow of the lens barrel was captured in the picture because the subject was too close to the camera. Move further away from the subject and shoot. If a hood is attached to the lens, remove it before taking the flash picture.

Full Auto Techniques (Scene Intelligent Auto)

Recomposing the Shot

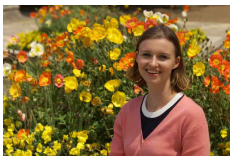

Depending on the scene, positioning the subject toward the left or right to include a balanced background will result in a picture with better perspective.

In the $\langle \text{AF}^+ \rangle$ mode, pressing the shutter button halfway to focus on a still subject will lock the focus on that subject. Recompose the shot while keeping the shutter button pressed halfway, and then press the shutter button completely to take the picture. This is called “focus lock”. Focus lock is also possible in other Basic Zone modes (except $\langle \text{SCN} \rangle$: ).

Shooting a Moving Subject



In the $\langle \text{AF}^+ \rangle$ mode, if the subject moves (distance to camera changes) during or after focusing, AI Servo AF will take effect to focus on the subject continuously. (The beeper will continue beeping softly.) As long as you keep the AF point positioned over the subject while pressing the shutter button halfway, focusing will be continuous. At the decisive moment, press the shutter button completely to take the picture.

Live View Shooting

You can shoot while viewing the image on the LCD monitor. This is called “Live View shooting”. For details, see page 180.

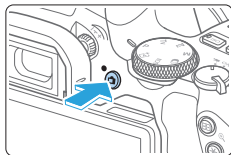

1 Display the Live View image on the LCD monitor.

- Press the  button.
- ➔ The Live View image will appear on the LCD monitor.

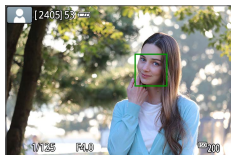

2 Focus on the subject.

- Press the shutter button halfway to focus.
- ➔ When focus is achieved, the AF point will turn green and the beeper will sound.

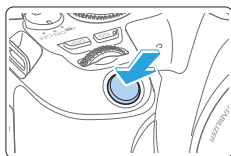

3 Take the picture.

- Press the shutter button completely.
- ➔ The picture is taken and the captured image is displayed on the LCD monitor.
- ➔ When the playback display ends, the camera will return to Live View shooting automatically.
- Press the  button to exit the Live View shooting.

You can also rotate the LCD monitor for different angles ( 40).



Normal angle



Low angle



High angle

Shooting with Effects Applied (Creative Assist)

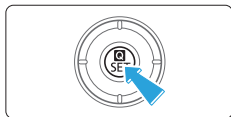

1 Press the <Q> button.

- In viewfinder shooting, use the <<>> <>> keys to select **[Creative Assist]**, then press <SET>.
- In Live View shooting, read the message and select **[OK]**.

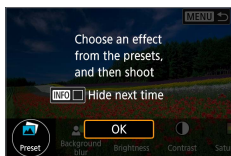

2 Select an effect.

- Use the <<>> <>> keys to select an effect, then press <SET>.

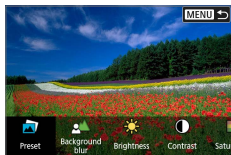

3 Select the effect level and other details.

- Use the <<>> <>> keys to set it, then press <SET>.
- To reset the setting, press the <✱> button, then select **[OK]**.



Creative Assist Effects







• [📷] Preset

Select one of the preset effects.



Note that **[Saturation]**, **[Color tone 1]**, and **[Color tone 2]** are not available with **[B&W]**.

• [📷] Background blur

Adjust background blur. Choose higher values to make backgrounds sharper. To blur the background, choose lower values. **[AUTO]** adjusts background blurring to match the brightness. Depending on lens brightness (f/number), some positions may not be available.

-  **Brightness**
Adjust image brightness.
-  **Contrast**
Adjust contrast.
-  **Saturation**
Adjust the vividness of colors.
-  **Color tone 1**
Adjust amber/blue color tone.
-  **Color tone 2**
Adjust green/magenta color tone.
-  **Monochrome**
Set the toning effect for monochrome shooting. Set to **[Off]** to shoot in color. **[Saturation]**, **[Color tone 1]**, and **[Color tone 2]** are not available with options other than **[Off]**.



- **[Background blur]** is not available when the flash is used.
- These settings are reset when you switch shooting modes or set the power switch to <OFF>. To save the settings, set : **Retain Creative Assist data** to **[Enable]**.
- <!> appears in the lower left of the viewfinder if you change the settings with : **Retain Creative Assist data** set to **[Enable]**.

Saving Effects

To save the current setting to the camera, press the <INFO> button on the Creative Assist setting screen, then select **[OK]**. Up to three presets can be saved as **[USER*]**. After three have been saved, an existing **[USER*]** preset must be overwritten to save a new one.

Special Scene Mode

The camera will automatically choose the appropriate settings when you select a shooting mode for your subject or scene.

* <SCN> stands for Special Scene.

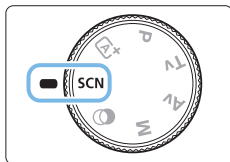

1 Set the Mode Dial to <SCN>.



2 Press the <Q> button.

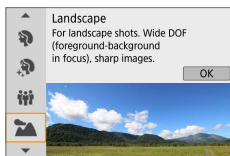

3 Select a shooting mode.

- Press the <▲> <▼> keys to select the desired shooting mode, then press <SET>.
- You can also select by turning the <📷> dial.

Available Shooting Modes in the SCN Mode

Shooting Mode	Page
Portrait	79
Smooth skin	80
Group Photo	81
Landscape	82
Sports	83
Kids	84

Shooting Mode	Page
Close-up	85
Food	86
Candlelight	87
Night Portrait	88
Handheld Night Scene	89
HDR Backlight Control	90

Shooting Portraits

The (Portrait) mode blurs the background to make the human subject stand out. It also makes skin tones and hair look softer.

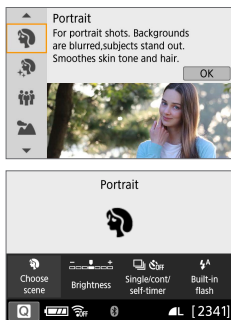

Shooting Tips

- **Select the location where the distance between the subject and the background is the farthest.**
The further the distance between the subject and background, the more blurred the background will look. The subject will also stand out better against an uncluttered dark background.
 - **Use a telephoto lens.**
If you have a zoom lens, use the telephoto end to fill the frame with the subject from the waist up. Move in closer as necessary.
 - **Focus on the face.**
Check that the AF point covering the face lights up. For close-ups of the face, focus on the eyes.
-  ● The default setting is (Continuous shooting). If you keep holding down the shutter button, you can shoot continuously to capture changes in the subject's facial expression and pose.

Shooting Portraits with Smooth Skin Tone

Use the (Smooth skin) mode to make skin look more attractive in portraits. Images are processed to make skin look smoother.

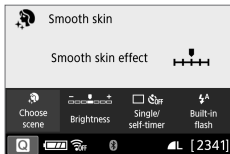
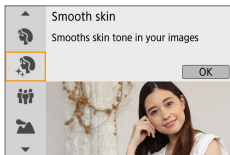

Shooting Tips

- **Adjust the face size.**

Frames are displayed around any main subjects detected for skin smoothing.

For more effective skin smoothing, you can adjust the size so that the frame is displayed on the subject's face.

- **Focus on the face.**

Check that the AF point covering the face lights up. For close-ups of the face, focus on the eyes.



- Areas other than people's skin may be modified, depending on the shooting conditions.
- In viewfinder shooting against bright backgrounds, or in similar conditions, skin may not be smoothed as expected, and faces may look too dark. In this case, adjust **[Brightness]** or switch to Live View shooting.

Shooting Group Photos

Use the (Group Photo) mode to shoot group photos. You can take a picture in which both the people in the front and people in the back are all in focus.

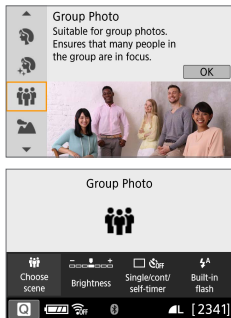

Shooting Tips

- **Use a wide-angle lens.**

When using a zoom lens, use the wide-angle end to make it easy to get all the people in the group in focus at once, from the front row to the back. Also, if you place a little distance between the camera and the subjects (so that the subjects' entire bodies are in the shot), the focus range increases in depth.

- **Take multiple shots of the group.**

It is recommended to shoot multiple photos in case some people close their eyes.



- See the cautions on page 91.



- When shooting indoors or in low-light, hold the camera steady or use a tripod to prevent camera shake.
- You can adjust the image brightness with **[Brightness]**.

Shooting Landscapes

Use the (Landscape) mode for wide scenery or to have everything in focus from near to far. For vivid blues and greens, and very sharp and crisp images.

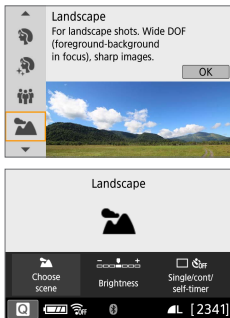

Shooting Tips

- **With a zoom lens, use the wide-angle end.**
When using a zoom lens, set the lens to the wide-angle end to make the objects near and far in focus. It also adds breadth to landscapes.
 - **Shooting night scenes.**
The mode is also good for night scenes because it disables the built-in flash. When shooting night scenes, use a tripod to prevent camera shake.
-  ● The built-in flash will not fire even in backlit or low-light conditions.

Shooting Moving Subjects

Use the <🏃> (Sports) mode to shoot a moving subject, such as a running person or a moving vehicle.

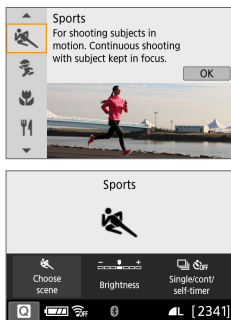

💡 Shooting Tips

- **Use a telephoto lens.**

Use of a telephoto lens is recommended for shooting from a distance.

- **Use the center AF point to focus.**

Aim the center AF point over the subject, then press the shutter button halfway to autofocus. During autofocusing, the beeper will continue beeping softly. If focus cannot be achieved, the focus indicator <●> will blink.

The default setting is <📷> (Continuous shooting). At the decisive moment, press the shutter button completely to take the picture. If you keep holding down the shutter button, you can shoot continuously while maintaining autofocus to capture changes in the subject's movement.



- The built-in flash will not fire even in backlit or low-light conditions.
- Under low light where camera shake tends to occur, the viewfinder's shutter speed display on the bottom left will blink. Hold the camera steady and shoot.
- If you are using an external Speedlite, the Speedlite will fire.

Photographing Children

When you want to continuously focus on and photograph children running around, use (Kids). Skin tones will look healthy.

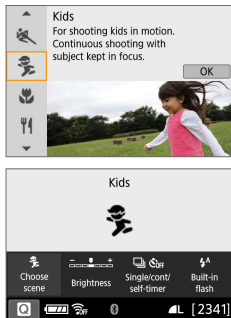

Shooting Tips

- **Use the center AF point to focus.**

Aim the center AF point over the subject, then press the shutter button halfway to autofocus. During autofocusing, the beeper will continue beeping softly. If focus cannot be achieved, the focus indicator will blink.

- **Shoot continuously.**

The default setting is (Continuous shooting). At the decisive moment, press the shutter button completely to take the picture. If you keep holding down the shutter button, you can shoot continuously while maintaining autofocusing to capture changes in the subject's facial expression and movement.



- While the flash is recharging, “buSy” is displayed in the viewfinder, and a picture cannot be taken. Take the picture after this display turns off.
- See the cautions on page 91.

Shooting Close-ups

When you want to shoot flowers or small things up close, use the <🌸> (Close-up) mode. To make small things appear much larger, use a macro lens (sold separately).

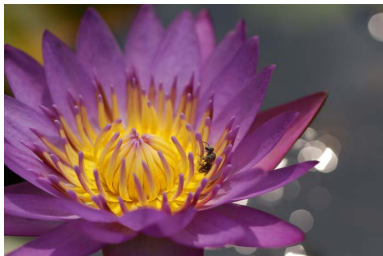
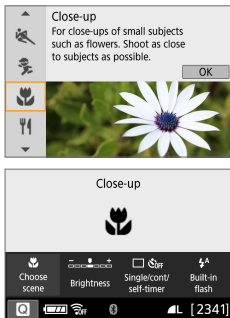

Shooting Tips

- **Use a simple background.**
A simple background makes small objects such as flowers stand out better.
- **Move in as close as possible to the subject.**
Check the lens for its minimum focusing distance. Some lenses have indications such as <0.25m/0.8ft> on them. The lens minimum focusing distance is measured from the <⊕> (focal plane) mark on the top of the camera to the subject. If you are too close to the subject and focus cannot be achieved, the focus indicator <●> will blink.
If the built-in flash is fired and the bottom part of the picture comes out unnaturally dark, move away a little from the subject and try again.
- **With a zoom lens, use the telephoto end.**
When using a zoom lens, using the telephoto end will make the subject look larger.

Shooting Food

When shooting food, use <Fork and Spoon> (Food). The photo will look bright and appetizing. Also, depending on the light source, the reddish tinge will be suppressed in the pictures taken under tungsten lights, etc.

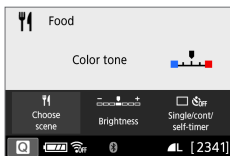
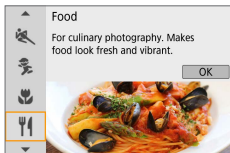

Shooting Tips

- **Change the color tone.**
You can change **[Color tone]**. To increase the food's reddish tinge, set it toward **[Warm]**. Set it toward **[Cool]** if it looks too red.
- **Avoid using flash.**
If you use flash, the light may reflect off the dish or food and results in unnatural shadows. Shooting without flash is recommended, but be careful about camera shake under low light.
- Since this mode lets you shoot the food in appetizing color tones, human subjects may be photographed with an unsuitable skin tone.
- The warm color cast of subjects may fade.
- When multiple light sources are included on the screen, the warm color cast of the picture may not be reduced.
- If you use flash, the **[Color tone]** setting will switch to the standard.

Shooting Candlelight Portraits

When you want to photograph a human subject lit in candlelight, use **<Candlelight>** (Candlelight). The atmosphere of candlelight is reflected in the color tones of the picture.

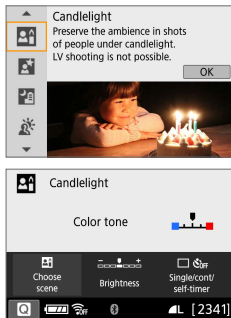

Shooting Tips

- **Use the center AF point to focus.**
Aim the center AF point in the viewfinder over the subject, then shoot.
 - **Prevent camera shake if the numeric display (shutter speed) in the viewfinder blinks.**
Under low light, the viewfinder's shutter speed display will blink. Hold the camera steady or use a tripod. When using a zoom lens, you can reduce the blur caused by camera shake by setting the lens to the wide-angle end.
 - **Change the color tone.**
You can change **[Color tone]**. To increase the candlelight's reddish tinge, set it toward **[Warm]**. Set it toward **[Cool]** if it looks too red.
-  ● Live View shooting is not possible.
- Although flash photography is not possible, raising the flash beforehand is recommended, to enable firing of the AF-assist beam (167).

Shooting Night Portraits (With a Tripod)

When you want to photograph people at night and obtain a natural-looking night scene in the background, use the <📷> (Night Portrait) mode. Using a tripod is recommended.

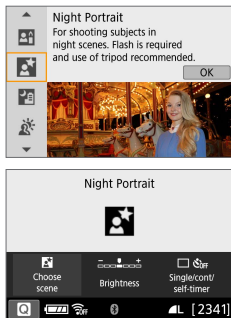

Shooting Tips

- **Use a wide-angle lens and a tripod.**

When using a zoom lens, use the wide-angle end to obtain a wide night view. Also, since camera shake is prone to occur with handheld shooting, use a tripod.

- **Check the subject's brightness.**

Under low light, using flash produces better shots of people. Note that it is recommended to play back the captured image on location to check the image brightness. If the subject looks dark, move nearer and shoot again.

- **Also shoot in other shooting modes.**

Since camera shake is prone to occur with night shots, shooting also with <A+> and <P> is recommended.



- Tell the subject to keep still even after the flash fires.
- See the cautions on page 91.

Shooting Night Scenes (Handheld)

Using a tripod when shooting a night scene gives the best results. However, the  (Handheld Night Scene) mode enables you to shoot night scenes even while handholding the camera. In this shooting mode, four shots are taken consecutively for each picture, and the resulting one image with reduced camera shake is recorded.

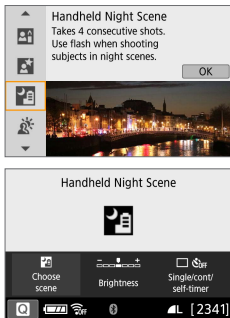

Shooting Tips



- **Hold the camera firmly.**

During shooting, hold the camera firmly and steadily. In this mode, four shots are aligned and merged into a single image. However, if there is significant misalignment in any of the four shots due to camera shake, they may not align properly in the final image.

- **For shots including people, fire the flash.**

For shots that include people, lift the built-in flash with your fingers. To take a nice portrait, the first shot will use flash. Tell the subject not to move until all four consecutive shots are taken.



- Compared to other shooting modes, the shooting range will be smaller.
- See the cautions on  91 -  92.

Shooting Backlit Scenes

When shooting a scene having both the bright and dark areas, use the (HDR Backlight Control) mode. When you take one picture in this mode, three consecutive shots are taken at different exposures. This results in one image, with a wide tonal range, that has minimized the clipped shadows caused by backlighting.

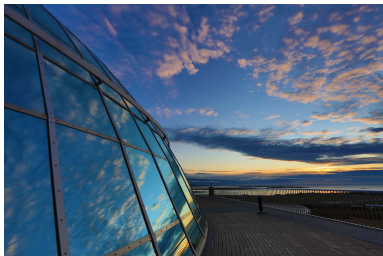
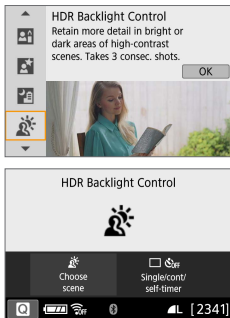

Shooting Tips

- **Hold the camera firmly.**

During shooting, hold the camera firmly and steadily. In this mode, three shots are aligned and merged into a single image. However, if there is significant misalignment in any of the three shots due to camera shake, they may not align properly in the final image.



- Compared to other shooting modes, the shooting range will be smaller.
- Although flash photography is not possible, raising the flash beforehand is recommended, to enable firing of the AF-assist beam (📖167).
- See the cautions on 📖91 - 📖92.



- HDR stands for High Dynamic Range.



Cautions for <[Group Photo Icon]> Group Photo

- Since distortion correction is applied, the camera records an image area narrower than the one seen through the viewfinder. (The image periphery is slightly trimmed and the resolution looks slightly lowered.) Also, during Live View shooting, the angle of view changes slightly.

Cautions for <[Kids Icon]> Kids

- During Live View shooting, if flash is fired in continuous shooting, the continuous shooting speed will decrease. Even if the flash is not fired for subsequent shots, shooting will still be performed with the decreased continuous shooting speed.

Cautions for <[Night Portrait Icon]> Night Portrait and <[Handheld Night Scene Icon]> Handheld Night Scene

- During Live View shooting, achieving focus may be difficult with point sources of light, such as may be found in a night scene. In such a case, set the lens's focus mode switch to <MF> and focus manually.
- The Live View image displayed will not look exactly the same as the actual captured image.

Cautions for <[Night Portrait Icon]> Night Portrait

- During Live View shooting, achieving focus may be difficult when the face of the subject looks dark. In such a case, set the lens's focus mode switch to <MF> and focus manually.

Cautions for <[Handheld Night Scene Icon]> Handheld Night Scene and <[HDR Backlight Control Icon]> HDR Backlight Control

- RAW image quality cannot be set.
- If you shoot a moving subject, the subject's movement may leave afterimages, or the surrounding area of the subject may become dark.
- The image alignment may not function properly with repetitive patterns (lattice, stripes, etc.), flat or single-tone images, or images significantly misaligned due to camera shake.
- It takes some time to record images to the card since they are merged after shooting. During the image processing, "buSy" will be displayed in the viewfinder, and you cannot take another picture until the processing is complete.



Cautions for Handheld Night Scene

- In flash photography, if the subject is too close to the camera, the picture may come out extremely bright (overexposure).
- In flash photography, if you shoot a night scene with limited lights, the shots may not align correctly. This may result in a blurry picture.
- In flash photography, if the human subject is close to the background that is also illuminated by the flash, the shots may not align correctly. This may result in a blurry picture. Unnatural shadows and unsuitable colors may also appear.
- Flash coverage angle with an external Speedlite:
 - When using a Speedlite with automatic flash coverage setting, the zoom position will be fixed to the wide (wide-angle) end regardless of the lens's zoom position.
 - When using a Speedlite requiring manual flash coverage setting, set the flash head to the normal position.

Cautions for HDR Backlight Control

- The image may not be rendered with a smooth gradation and may look irregular or have significant noise.
- HDR Backlight Control may not be effective for excessively backlit scenes or extremely high-contrast scenes.
- When shooting subjects that are sufficiently bright as they are, for example for normally lit scenes, the image may look unnatural due to the HDR effect.

Shooting with Creative Filter Effects

In the <📷> (Creative filters) mode, you can apply one of ten filter effects (Grainy B/W*, Soft focus*, Fish-eye effect*, Water painting effect*, Toy camera effect*, Miniature effect*, HDR art standard, HDR art vivid, HDR art bold, and HDR art embossed) for shooting. When the camera is set for Live View shooting, you can see the effect on the screen before you start shooting. The camera saves only the image with the Creative filter effects applied.

* For the effects marked with an asterisk, you can also take a picture without a Creative filter, then apply the effect afterward and save it as a new image (📖329).

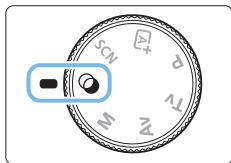

1 Set the Mode Dial to <📷>.



2 Display the Live View image.

- Press the <📷> button to display the Live View image.

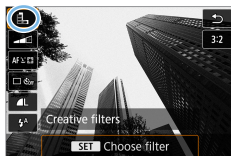

3 Select [Creative filters] with Quick Control.

- Press the <Q> button.
- Press the <▲> <▼> keys to select [📷] on the upper left of the screen, then press <SET>.





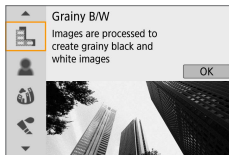







- If you do not want the Live View image to be displayed when setting functions, press the <Q> button after step 1 and select [Choose filter].













4 Select a shooting mode.

- Press the <▲> <▼> keys to select a shooting mode, then press <SET>.
- ➔ The image will be displayed with the effects of the filter applied.

Available Shooting Modes in the Mode

Shooting Mode	Page
 Grainy B/W	 95
 Soft focus	 95
 Fish-eye effect	 95
 Water painting effect	 95
 Toy camera effect	 95

Shooting Mode	Page
 Miniature effect	 96
 HDR art standard	 96
 HDR art vivid	 96
 HDR art bold	 96
 HDR art embossed	 96

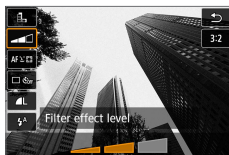

5 Adjust the effect.

- Press the <Q> button and select the icon below [**Creative filters**] (except for , , , , and ).
- Press the <◀> <▶> keys to adjust the effect, then press <SET>.

6 Take the picture.

- Press the shutter button completely to take the picture.
- To return to viewfinder shooting, press the <📷> button to exit Live View shooting. Then press the shutter button completely to take the picture.







- RAW image quality cannot be set.
- When <📷>, <👤>, <🎯>, <🖌️>, <📷>, or <📷> is set, continuous shooting cannot be set.
- Dust Delete Data (📖274) will not be appended to images shot with Fish-eye effect applied.







During Live View Shooting

- With Grainy B/W, the grainy effect displayed on the LCD monitor will look different from the grainy effect recorded in the picture.
- With the Soft focus and Miniature effects, the blurred effect displayed on the LCD monitor may look different from the blurred effect recorded in the picture.
- The histogram is not displayed.
- Magnified view is not possible.
- In Creative Zone modes, you can set some Creative filters with Quick Control (p.93).

Creative Filter Characteristics

-  **Grainy B/W**
Creates a grainy black-and-white photo. You can change the black-and-white effect by adjusting the contrast.
-  **Soft focus**
Gives the image a soft look. You can change the degree of softness by adjusting the blur.
-  **Fish-eye effect**
Gives the effect of a fish-eye lens. The image will have a barrel-type distortion.
Depending on the level of this filter effect, the area trimmed along the periphery of the image changes. Also, since this filter expands the center part of the image, the resolution at the center may decrease depending on the number of recorded pixels. Check the image on the screen when setting this filter. The AF point will be fixed to the one at the center.
-  **Water painting effect**
Makes the photo look like a watercolor painting with soft colors. You can control the color density by adjusting the filter effect. Note that night scenes or dark scenes may not be rendered with a smooth gradation and may look irregular or have significant noise.
-  **Toy camera effect**
Darkens the photo's corners and applies a unique color tone that makes it look as if it was shot by a toy camera. You can change the color cast by adjusting the color tone.

-  **Miniature effect**
Creates a diorama effect.
If you want the image center to look sharp, take the picture without changing any setting.
To move the area that looks sharp (miniature effect frame) in Live View shooting, see “Adjusting Miniature Effect” (📖98). 1-point AF is used as the AF method. Positioning the miniature effect frame over the AF point before shooting is recommended.
During viewfinder shooting, aim the center AF point over the subject and shoot.
-  **HDR art standard**
Clipped highlights and shadows will be reduced. The low contrast and flat gradation create a painting-like effect. The subject outlines will have bright (or dark) edges.
-  **HDR art vivid**
The colors are more saturated than with **[HDR art standard]**, and the low contrast and flat gradation create a graphic art effect.
-  **HDR art bold**
The colors are the most saturated, making the subject pop out, and the picture looks like an oil painting.
-  **HDR art embossed**
The color saturation, brightness, contrast and gradation are decreased to make the picture look flat. The picture looks faded and old. The subject outlines will have bolder bright (or dark) edges.



Cautions for HDR Art Standard, HDR Art Vivid, HDR Art Bold, and HDR Art Embossed

- Compared to other shooting modes, the image area will be smaller.
- The Live View image displayed with the filter applied will not look exactly the same as the actual captured image.
- If you shoot a moving subject, the subject's movement may leave afterimages, or the surrounding area of the subject may become dark.
- The image alignment may not function properly with repetitive patterns (lattice, stripes, etc.), flat or single-tone images, or images significantly misaligned due to camera shake.
- If you are handholding the camera, try to prevent camera shake when shooting.
- The color gradation of the sky or white walls may not be reproduced correctly. Irregular exposure, irregular colors, or noise may appear.
- Shooting under fluorescent or LED lighting may result in unnatural color reproduction of the illuminated areas.
- It takes some time to record images to the card since they are merged after shooting. During the image processing, “buSy” will be displayed in the viewfinder, and you cannot take another picture until the processing is complete.
- Although flash photography is not possible, in low light, raising the flash beforehand is recommended, to enable firing of the AF-assist beam (167).



- For , clipped highlights and shadows will be reduced for a high dynamic range of tones even with high-contrast scenes. **Three images of different exposures are captured continuously for each shot and merged into a single image.**

Adjusting Miniature Effect



1 Move the AF point.

- Move the AF point to where you want to focus on.



2 Move the miniature effect frame.

- Move the miniature effect frame if the AF point is outside of it, so that the AF point is aligned with it.
- Press the $\langle \text{Q} \rangle$ button (or tap on the $\left[\text{Q} \right]$ icon at the bottom right of the screen). The miniature effect frame will turn orange and can be moved.
- Press the $\langle \text{INFO} \rangle$ button (or tap on the $\left[\text{INFO} \right]$ icon at the bottom left of the screen) to switch between the vertical and horizontal orientations of the miniature effect frame.
- Press $\langle \text{SET} \rangle$ to set the position of the miniature effect frame.
- Press $\langle \blacktriangle \rangle$ $\langle \blacktriangledown \rangle$ or $\langle \blacktriangleleft \rangle$ $\langle \blacktriangleright \rangle$ to move the AF point or miniature effect frame. Press the $\langle \text{RESET} \rangle$ button to return the AF point or miniature effect frame to the screen center.

3 Take the picture.

Quick Control

You can directly select and set settings accessed by pressing the **<Q>** button in Basic Zone modes.

1 Set the Mode Dial to a Basic Zone mode.

2 Press the **<Q>** button.

→ The Quick Control screen will appear.

3 Set the desired functions.

- Press the **<◇>** cross keys to select a function.
- The settings of the selected function and Feature guide (📖55) will appear.
- Turn the **<☀>** dial to change the setting.
- You can also select from a list by selecting a function and pressing **<SET>**.

- When [**📷: Shooting screen: Standard**] is set, a screen such as the following will appear.

Example: **<Q>**

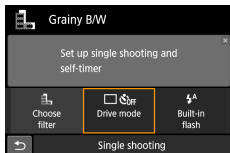
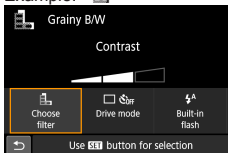

Adjusting the Brightness

This section describes how to adjust brightness for shooting in <SCN> modes other than <SCN: []>. You can adjust both the brightness and darkness across 3-step ranges with 0 being the standard.



1 Set the Mode Dial to <SCN>:



- Set to any mode other than <[]>.

2 Display the Live View image.

- Press the <[]> button to display the Live View image (except <[]>).

3 With Quick Control, select the desired brightness.

- Press the <[Q]> button.
- Press the <[▲]> <[▼]> keys to select [Brightness], then press the <[◀]> <[▶]> keys to select the desired brightness.

➔ The image with the selected brightness adjustment applied will appear.

4 Take the picture.

- Press the shutter button completely to take the picture.
- To return to viewfinder shooting, press the <[]> button to exit Live View shooting. Then press the shutter button completely to take the picture.
- If you change the shooting mode or set the power switch to <OFF>, the setting will revert to [0] (standard).



- If you do not want the Live View image to be displayed when setting functions, start the procedure from step 3.

Image Playback

The easiest way to play back images is described below. For more details on the playback procedure, see page 280.

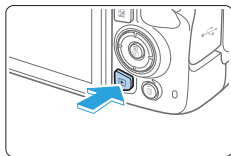

1 Play back the image.

- Press the <▶> button.
- ➔ The last image captured or played back will appear.

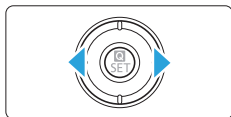

2 Select an image.

- To play back images starting with the last image captured, press the <◀> key. To play back images starting with the first captured image, press the <▶> key.
- Each time you press the <INFO> button, the display will change.



No information



Basic information display

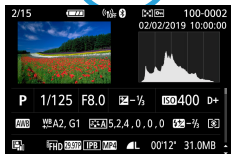

Shooting information display

3 Exit the image playback.

- Press the <▶> button to exit the image playback and return to shooting-ready state.

Shooting Information Display

With the shooting information screen displayed (📖101), you can press the <▲> <▼> keys to change the shooting information displayed at the screen bottom as follows. For details, see 📖324 - 📖325.

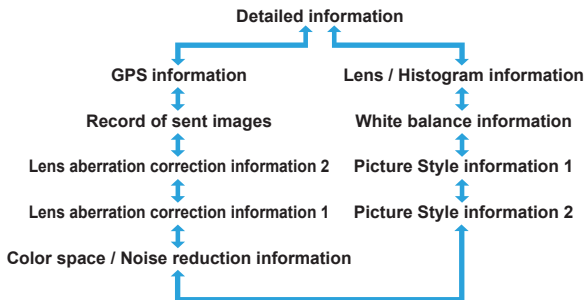

- The information displayed varies depending on the shooting mode and settings.
- If you use GPS Receiver GP-E2 or a smartphone to record GPS information for the image, the “GPS information” screen will also appear.

Setting the AF and Drive Modes

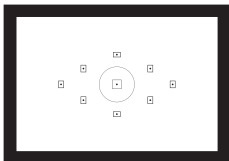

The AF points in the viewfinder are arranged to make AF shooting suitable for a wide variety of subjects and scenes.

You can also select the AF operation and drive mode that best match the shooting conditions and subject.

- The ☆ icon at the upper right of the page title indicates that the function is available only in Creative Zone modes (31).
- In Basic Zone modes, the AF operation is set automatically.



- <AF> stands for autofocus. <MF> stands for manual focus.

Changing the Autofocus Operation ☆

You can select the AF (autofocus) operation characteristics to suit the shooting conditions or subject. In Basic Zone modes, the optimum AF operation is set automatically for the respective shooting mode.

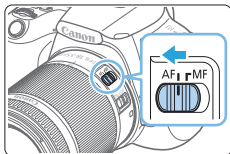

1 Set the lens focus mode switch to <AF>.

2 Turn the Mode Dial to a Creative Zone mode.

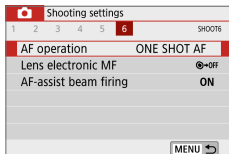

3 Select [AF operation].

- Under the [📷] tab, select [AF operation], then press <SET>.

➔ [AF operation] will appear.

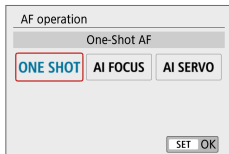

4 Select the AF operation.

- Press the <◀> <▶> keys to select the desired AF operation, then press <SET>.

5 Focus on the subject.

- Aim the AF point over the subject and press the shutter button halfway. The camera will then autofocus in the selected AF operation.

One-Shot AF for Still Subjects



Suited for still subjects. When you press the shutter button halfway, the camera will focus only once.

- The dot inside the AF point (1) achieving focus lights up briefly in red, and the focus indicator <●> (2) in the viewfinder will also light up.
- With evaluative metering, the exposure setting will be set at the same time focus is achieved.
- While you keep holding down the shutter button halfway, the focus will be locked. You can then recompose the shot if desired.



- If focus cannot be achieved, the focus indicator <●> in the viewfinder will blink. If this occurs, the picture cannot be taken even if the shutter button is pressed completely. Recompose the shot or see “Subjects Difficult to Focus on” (📖 110) and try to focus again.
- If [**🔊: Beep**] is set to [**Disable**], the beeper will not sound when focus is achieved.
- After achieving focus with One-Shot AF, you can lock the focus on a subject and recompose the shot. This is called “focus lock”. This is useful when you want to focus on a peripheral subject.
- When a lens equipped with an electronic manual focusing function is used, see page 107.

AI Servo AF for Moving Subjects

This AF operation is suited for moving subjects when the focusing distance keeps changing. While you hold down the shutter button halfway, the camera will keep focusing on the subject continuously.

- The exposure is set at the moment the picture is taken.
- When the AF point selection (📖108) is automatic, the camera first uses the center AF point to focus. During autofocus, if the subject moves away from the center AF point, focus tracking continues as long as the subject is covered by another AF point.



- With AI Servo AF, the beeper will not sound even when focus is achieved. Also, the focus indicator <●> in the viewfinder will not light up.

AI Focus AF for Switching the AF Operation Automatically

AI Focus AF switches the AF operation from [One-Shot AF] to [AI Servo AF] automatically if a still subject starts moving.

- After the subject is in focus in One-Shot AF, if the subject starts moving, the camera will detect the movement, change the AF operation automatically to AI Servo AF, and start tracking the moving subject.



- When focus is achieved with AI Focus AF with the Servo operation active, the beeper will continue beeping softly. However, the focus indicator <●> in the viewfinder will not light up. Note that focus lock is not possible in this case.

AF-Assist Beam with the Built-in Flash

Under low-light conditions, when you press the shutter button halfway, the built-in flash may fire a brief burst of flashes. This illuminates the subject to help autofocusing.



- AF-assist beam will not be emitted from the built-in flash in <SCN: 🏠 🌊 🌧 🌩 > modes.
- The AF-assist beam will not be emitted with AI Servo AF operation.
- The built-in flash makes a sound when firing continuously. This is normal and not a malfunction.



- The effective range of the AF-assist beam emitted by the built-in flash is approx. 4 meters/13.1 feet.
- The AF-assist beam is fired as needed when the built-in flash has been raised. To prevent it from firing, set [: AF-assist beam firing] to [Disable] (167).

Setting Lens Electronic MF

With USM and STM lenses equipped with electronic manual focusing function, you can set whether to use electronic manual focusing in One-Shot AF mode. The default setting is [Disable after One-Shot AF].

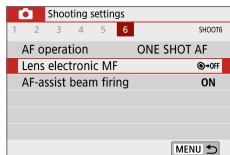

1 Select [Lens electronic MF].

- Under the [] tab, select [Lens electronic MF], then press <SET>.

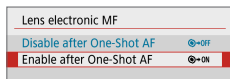

2 Set the desired setting.

- Select the setting, then press <SET>.

- **Disable after One-Shot AF**

Manual focus adjustment after the AF operation is disabled.

- **Enable after One-Shot AF**

You can manually adjust the focus after the AF operation if you keep holding down the shutter button halfway.

Selecting the AF Point

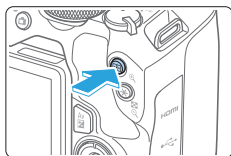

1 Press the $\langle \text{Grid} \rangle$ button.

- ➔ The selected AF point will be displayed on the LCD monitor and in the viewfinder.

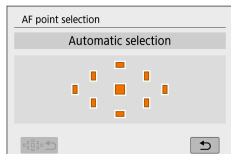

2 Select the AF point.

- Use the $\langle \text{Cross} \rangle$ keys to select the AF point.
- To select the AF point while looking in the viewfinder, turn the $\langle \text{Dial} \rangle$ dial to switch the point lit in red.
- When all the AF points light up, automatic AF point selection will be set. The AF point will be selected automatically to focus on the subject.
- Pressing $\langle \text{SET} \rangle$ toggles the AF point selection between the center AF point and automatic AF point selection.

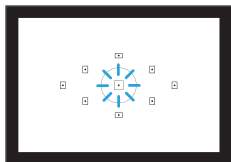

3 Focus on the subject.

- Aim the selected AF point over the subject and press the shutter button halfway to focus.



- You can also tap on the LCD monitor screen to select the AF point. During manual AF point selection, tapping on the $[\text{Grid}/\text{Cross}]$ icon at the bottom left of the screen will switch the mode to automatic AF point selection.
- If you set $[\text{Fn}: \text{Switch Grid}/\text{Cross} \text{ button}]$ to $[\text{Enable}]$, you can switch the functions of the $\langle \text{Grid} \rangle$ button and $\langle \text{Cross} \rangle$ button.



Shooting Tips

- **When shooting a portrait up close, use [One-Shot AF] and focus on the eyes.**
Focus on the subject's eyes before composing your shot.
 - **If it is difficult to focus, select the center AF point.**
The center AF point has the highest focusing performance among the nine AF points.
 - **For easier tracking of moving subjects, use [Automatic selection] in conjunction with [AI Servo AF] of AF operation (📖 106).**
The center AF point will first be used to focus on the subject. During autofocusing, if the subject moves away from the center AF point, focus tracking continues as long as the subject is covered by another AF point.
-  ● If you use an extender (sold separately) in combination and the open aperture f /number becomes higher than $f/5.6$, AF shooting will not be possible (except in Live View shooting). For details, refer to the extender's instruction manual.

Subjects Difficult to Focus on

Autofocus may fail to achieve focus (focus indicator <●> in the viewfinder blinks) with special subjects such as the following:

- Subjects with very low contrast (Example: Blue skies, solid-color flat surfaces, etc.)
- Subjects in very low light
- Strongly backlit or reflective subjects (Example: Car with a highly reflective body, etc.)
- Near and distant subjects positioned close to an AF point (Example: Animals in cages, etc.)
- Light source such as dots of light positioned close to an AF point (Example: Night scenes, etc.)
- Subjects with repetitive patterns (Example: Skyscraper windows, computer keyboards, etc.)
- Subjects with finer patterns than an AF point (Example: Faces or flowers as small as or smaller than an AF point, etc.)

In such cases, focus in either of the following two ways.

- (1) With One-Shot AF, focus on an object at the same distance as the subject and lock the focus, then recompose the shot (📖 74).
- (2) Set the lens's focus mode switch to <MF> and focus manually.



- Depending on the subject, focus may be achieved by slightly recomposing the shot and performing AF operation again.
- For conditions that make focusing difficult with AF during Live View shooting or movie shooting, see page 202.

MF: Manual Focus

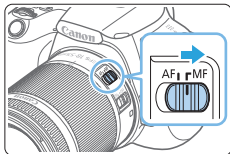

- 1 Set the lens's focus mode switch to <MF>.**

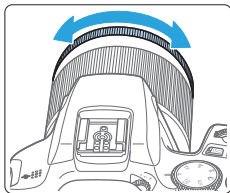

- 2 Focus on the subject.**
 - Focus by turning the lens focusing ring until the subject looks sharp in the viewfinder.



- If you press the shutter button halfway and focus manually, the AF point achieving focus will light up briefly in red, and the focus indicator <●> will light up in the viewfinder.

Selecting the Drive Mode

Single and continuous drive modes are provided.

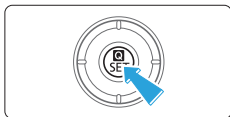



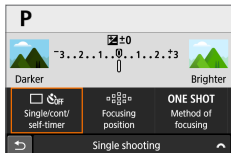

- 1 Press the <Q> button.**
→ The Quick Control screen will appear.

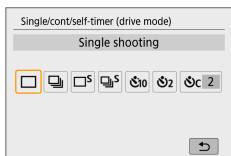

- 2 Select [OFF].**
 - Press the <◇> cross keys to select [OFF], then press <SET>.



- 3 Select the drive mode.**
 - Press the <◀> <▶> keys to select the desired drive mode, then press <SET>.

-  : **Single shooting**
When you press the shutter button completely, only one shot will be taken.
-  : **Continuous shooting**
When you press the shutter button completely, the camera will shoot continuously while you keep holding it down.
-  : **Silent single shooting** *
When you press the shutter button completely, only one shot will be taken quietly.
-  : **Silent continuous shooting** *
When you press the shutter button completely, the camera will shoot continuously quietly while you keep holding it down.
-  : **Self-timer: 10 sec/Remote control**
(when Wireless Remote Control BR-E1 (sold separately) is used)

 **Self-timer: 2 sec**

 **Self-timer: Continuous**

For self-timer shooting, see page 206. For remote control shooting with the BR-E1, see page 463.







- The continuous shooting speed may become slower depending on the shutter speed, aperture, subject conditions, brightness, lens, flash use, temperature, power source, remaining battery level, etc.
- With Live View shooting, the  and  cannot be set.
- The continuous shooting speed may become slower if the remaining battery level is low or if you shoot under low-light conditions.
- In AI Servo AF operation, the continuous shooting speed may become slightly slower depending on the subject conditions and the lens used.
- When internal memory becomes full during continuous shooting, the continuous shooting speed may drop off because shooting will be temporarily disabled.
- When the camera is paired with BR-E1,  will change to  ( 463).

Image Settings

This chapter describes image-related function settings: Image-recording quality, ISO speed, Picture Style, white balance, Auto Lighting Optimizer, noise reduction, lens aberration correction, and other functions.

- The ☆ icon at the upper right of the page title indicates that the function is available only in Creative Zone modes (📖31).

Setting Image Quality

You can select the pixel count and the image quality. JPEG image quality options include **L**, **L**, **M**, **M**, **S1**, **S1**, and **S2**. RAW image quality options include **RAW** and **CRAW**.

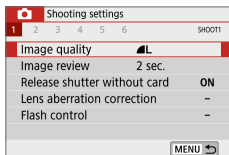

1 Select the image-recording quality.

- Under the [📷] tab, select [Image quality], then press <SET>.

➔ [Image quality] will appear.

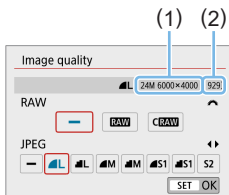

2 Set the image-recording quality.

- To select the RAW quality, turn the <⚙️> dial, and to select the JPEG quality, press the <◀> <▶> keys.
- Select the image-recording quality, referring to the respective quality's pixel count (1) and number of possible shots (2) displayed on the screen, then press <SET>.



- Even if you use a UHS-I class card, the maximum burst indicator will not change.
- Meaning of image quality icons: **RAW** RAW, **CRAW** Compact RAW, JPEG, **L** Fine, **L** Normal, **L** Large, **M** Medium, **S** Small.

- I want to select the image-recording quality matching the paper size for printing.

Paper size

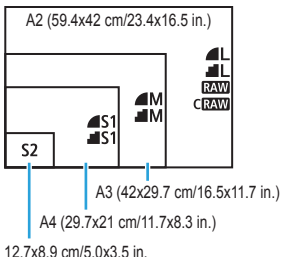

Refer to the diagram on the left when choosing the image-recording quality. If you want to crop the image, selecting a higher quality (more pixels) such as **L**, **M**, **RAW**, or **CRAW** is recommended.

S2 is suitable for playing back the image with a digital photo frame.

- What's the difference between **L** and **M**?

These settings indicate the different levels of image quality caused by different compression rates. The **L** setting produces a higher image quality with the same number of pixels. Although **M** produces a slightly lower image quality, this allows more images to be saved on the card. **S2** will be in **L** (Fine) quality.

- I was able to take more shots than the number of possible shots indicated.

Depending on the shooting conditions, you may be able to take more shots than is indicated. On the contrary, it may also be fewer than indicated. The number of possible shots displayed is only approximate.

- Does the camera display the maximum burst?

The maximum burst is displayed on the viewfinder's right side. Since it is only a single-digit indicator **0 - 9**, any number higher than 8 will be displayed only as "9". Note that this number will also be displayed even when no card is installed in the camera. Be careful not to shoot without a card in the camera.

- When should I use **RAW** or **CRAW**?

RAW and **CRAW** images must be processed on a computer. For details, see "RAW Images and JPEG Images" (📖117).

RAW Images and JPEG Images

- RAW images are raw data from the image sensor that are recorded to the card digitally as **RAW** or **CRAW** (smaller than **RAW**) files, depending on your selection.
You can use Digital Photo Professional (EOS software) to process RAW images. You can make various adjustments to images depending upon how they will be used and can generate JPEG or other types of images reflecting the effects of those adjustments.
- If **[-]** is set for both the RAW image and JPEG image, **▲L** will be set.
- If you select both RAW and JPEG, each time you shoot, the image will be recorded simultaneously to the card in both RAW and JPEG at the image-recording qualities that were set. The two images will be recorded with the same file numbers (1). The file extension (2) is .JPG for JPEG and .CR3 for RAW.



RAW Image Processing Software

- To display RAW images on a computer, using Digital Photo Professional (hereafter DPP, EOS software) is recommended (📖482).
- Previous versions of DPP Ver.4.x cannot process RAW images taken with this camera. If a previous version of DPP Ver.4.x is installed on your computer, obtain and install the latest version of DPP from the Canon Web site to update it. (The previous version will be overwritten.) Note that DPP Ver.3.x or earlier cannot process RAW images taken with this camera.
- Commercially-available software may not be able to display RAW images taken with this camera. For compatibility information, contact the software manufacturer.

Setting the ISO Speed for Still Photos ☆

Set the ISO speed (image sensor's sensitivity to light) to suit the ambient light level. In Basic Zone modes, the ISO speed is set automatically. Regarding the ISO speed during movie shooting, see [☞219](#), [☞219](#), and [☞222](#).



1 Press the <ISO> button.

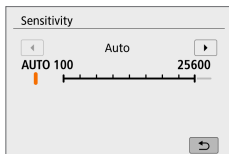

2 Set the ISO speed.

- While looking in the viewfinder or at the LCD monitor, press the <◀> <▶> keys or turn the <⌚> dial to select the desired ISO speed, then press <SET>.
- ISO speed can be set within ISO 100 - ISO 25600.
- With **[AUTO]** selected, the ISO speed will be set automatically ([☞119](#)).
- When setting from **[ISO speed]** in **[☑: ISO speed settings]** (shown at left), you can press the <INFO> button to specify **[AUTO]**.

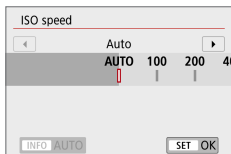

ISO Speed Guide

- Low ISO speeds reduce image noise but may increase the risk of camera/subject shake or reduce the area in focus (shallower depth of field), in some shooting conditions.
- High ISO speeds enable low-light shooting, a larger area in focus (deeper depth of field), and longer flash range but may increase image noise.



- Can also be set from **[ISO speed]** in **[☑: ISO speed settings]**.
- Under **[☑: Custom Functions(C.Fn)]**, if **[ISO expansion]** is set to **[1:On]**, "H" (equivalent to ISO 51200) can also be selected ([☞448](#)).



- If **[📷: Highlight tone priority]** is set to **[Enable]** or **[Enhanced]**, ISO 100 and “H” (equivalent to ISO 51200) cannot be selected (137).
- Shooting in high temperatures may result in images that look grainier. Long exposures can also cause irregular colors in the image.
- When you shoot at high ISO speeds, noise (such as dots of light and banding) may become noticeable.
- If you use a high ISO speed and flash to shoot a close subject, overexposure may result.
- When shooting in conditions that produce an extreme amount of noise, such as a combination of high ISO speed, high temperature, and long exposure, images may not be recorded properly.
- As “H” (equivalent to ISO 51200) is an expanded ISO speed setting, noise (dots of light, banding, etc.) and irregular colors will be more noticeable, and the resolution will be lower compared to the standard setting.

Automatic ISO speed setting: ISO [AUTO]

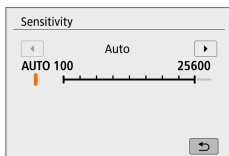

- If the ISO speed is set to **[AUTO]**, the actual ISO speed setting will be displayed in the viewfinder or on the LCD monitor when you press the shutter button halfway.
- When **[AUTO]** is set, the ISO speed is indicated in whole-stop increments. However, the ISO speed is actually set in finer increments. Therefore, in the image's shooting information (323), you may find an ISO speed such as ISO 125 or ISO 640 displayed as the ISO speed.

Setting the Maximum ISO Speed for [AUTO]

For ISO Auto, you can set the maximum ISO speed limit within ISO 400 - ISO 25600.

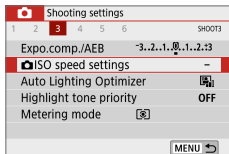

- 1 Select [ISO speed settings].**
 - Under the [CAMERA] tab, select [ISO speed settings], then press <SET>.

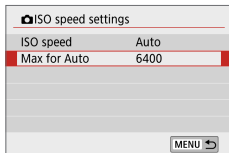

- 2 Select [Max for Auto].**
 - Select [Max for Auto], then press <SET>.

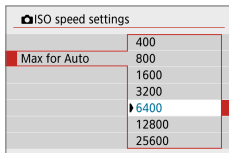

- 3 Select the ISO speed.**
 - Select the ISO speed, then press <SET>.

Selecting a Picture Style



Just by selecting a preset Picture Style, you can obtain image characteristics effectively matching your photographic expression or the subject.

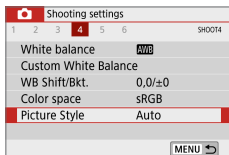

1 Select [Picture Style].

- Under the [] tab, select [Picture Style], then press <SET>.
- ➔ The Picture Style selection screen will appear.

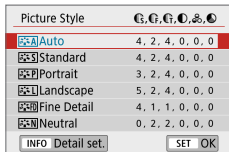

2 Select a Picture Style.

- Select a Picture Style, then press <SET>.
- ➔ The Picture Style will be set.

Picture Style Characteristics

Auto

The color tone will be adjusted automatically to suit the scene. The colors will look vivid for blue skies, greenery and sunsets, particularly in nature, outdoor and sunset scenes.



- If the desired color tone is not obtained with [Auto], use another Picture Style.

Standard

The image looks vivid, sharp, and crisp. This is a general-purpose Picture Style suitable for most scenes.

Portrait

For nice skin tones. The image looks softer. Suited for close-up portraits.

By changing the [Color tone] (125), you can adjust the skin tone.

Landscape

For vivid blues and greens, and very sharp and crisp images. Effective for impressive landscapes.

Fine Detail

Suited for detailed outline and fine texture description of the subject. The colors will be slightly vivid.

Neutral

Geared for users who prefer to process images with their computer. For natural colors and subdued images with modest brightness and color saturation.

Faithful

Geared for users who prefer to process images with their computer. The color of a subject that is captured in ambient light at a color temperature of 5200K will be adjusted to match the subject's colorimetric color. For subdued images with modest brightness and color saturation.

Monochrome

Creates black-and-white images.



- Black-and-white images shot in JPEG cannot be turned into color. Be careful not to leave the **[Monochrome]** setting on when you want to shoot photos in color again.



- You can set the camera to display <!> in the viewfinder for when **[Monochrome]** is set (📖450).

User Defined 1-3

You can register a basic style such as **[Portrait]**, **[Landscape]**, a Picture Style file, etc. and adjust it as desired (📖127). With any of the User Defined Picture Style that has not yet been set, pictures will be taken with the same characteristics settings as with the default settings of **[Auto]**.

Symbols

The Picture Style selection screen has icons for **[Strength]**, **[Fineness]**, or **[Threshold]** for **[Sharpness]** as well as **[Contrast]** and other parameters. The numerals indicate the values for these parameters set for the respective Picture Style.

Picture Style		G, G, G, D, S, *
Auto	4, 2, 4, 0, 0, 0	
Standard	4, 2, 4, 0, 0, 0	
Portrait	3, 2, 4, 0, 0, 0	
Landscape	5, 2, 4, 0, 0, 0	
Fine Detail	4, 1, 1, 0, 0, 0	
Neutral	0, 2, 2, 0, 0, 0	

INFO Detail set. SET OK

Picture Style		G, G, G, D, S, *
Fine Detail	4, 1, 1, 0, 0, 0	
Neutral	0, 2, 2, 0, 0, 0	
Faithful	0, 2, 2, 0, 0, 0	
Monochrome	4, 2, 4, 0, N, N	
User Def. 1	Auto	
User Def. 2	Auto	

INFO Detail set. SET OK

Symbols

	Sharpness	
		Strength
		Fineness
	Threshold	
	Contrast	
	Saturation	
	Color tone	
	Filter effect (Monochrome)	
	Toning effect (Monochrome)	

- During movie shooting, “*” will be displayed for both **[Fineness]** and **[Threshold]** for **[Sharpness]**. **[Fineness]** and **[Threshold]** will not be applied to movies.

Customizing a Picture Style



You can customize the Picture Styles. You can change or adjust the parameter settings of Picture Styles such as **[Strength]**, **[Fineness]**, or **[Threshold]** for **[Sharpness]** as well as **[Contrast]** and other parameters from the default settings. To see the resulting effects, take test shots. To customize **[Monochrome]**, see page 126.

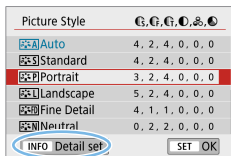

1 Select [Picture Style].

- Under the **[P]** tab, select **[Picture Style]**, then press **<SET>**.
- The Picture Style selection screen will appear.

2 Select a Picture Style.

- Select a Picture Style, then press the **<INFO>** button.

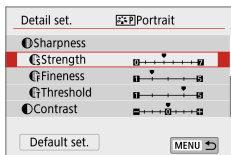

3 Select a parameter.

- Select the parameter (such as **[Strength]** of **[Sharpness]**) to be set, then press **<SET>**.
- See page 125 for settings and effects.

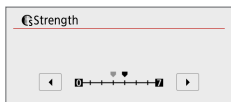





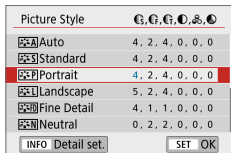

4 Set the parameter.

- Press the **<◀>** **<▶>** keys to adjust the effect of the parameter, then press **<SET>**.
- Press the **<MENU>** button to save the adjusted parameter settings. The Picture Style selection screen will reappear.
- The value of parameter settings different from the default will be displayed in blue.



Settings and Effects

	Sharpness		
		Strength	0: Weak outline emphasis 7: Strong outline emphasis
		Fineness* ¹	1: Fine 5: Grainy
		Threshold* ²	1: Low 5: High
	Contrast	-4: Low contrast +4: High contrast	
	Saturation	-4: Low saturation +4: High saturation	
	Color tone	-4: Reddish skin tone +4: Yellowish skin tone	

- *1: Indicates the fineness of the outlines to be emphasized. The smaller the number, the finer the outlines that can be emphasized.
- *2: Sets how much the outline is emphasized based on the difference in contrast between the subject and the surrounding area. The smaller the number, the more the outline will be emphasized when the contrast difference is low. However, noise tends to be more noticeable when the number is smaller.



- For movie shooting, **[Fineness]** and **[Threshold]** for **[Sharpness]** cannot be set (not displayed).
- By selecting **[Default set.]** in step 3, you can revert the parameter settings of the respective Picture Style to their defaults.
- To shoot with the Picture Style you adjusted, first select the adjusted Picture Style, then shoot.

Monochrome Adjustment

Besides the effects described on “Settings and Effects” (📖 125) such as **[Contrast]**, or **[Strength]**, **[Fineness]** and **[Threshold]** for **[Sharpness]**, you can also set **[Filter effect]** and **[Toning effect]**.

Filter effect

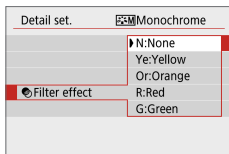

With a filter effect applied to a monochrome image, you can make white clouds or green trees stand out more than the original.

Filter	Sample Effects
N : None	Normal black-and-white image with no filter effects.
Ye : Yellow	The blue sky will look more natural, and the white clouds will look crisper.
Or : Orange	The blue sky will look slightly darker. The sunset will look more brilliant.
R : Red	The blue sky will look quite dark. Fall leaves will look crisper and brighter.
G : Green	Skin tones and lips will appear muted. Green tree leaves will look crisper and brighter.



- Increasing the **[Contrast]** will make the filter effect more pronounced.

Toning effect

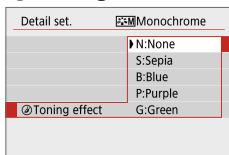

By applying a toning effect, you can create a monochrome image in the selected color. Effective when you want to create more impressive images.

The following can be selected: **[N:None]**, **[S:Sepia]**, **[B:Blue]**, **[P:Purple]** or **[G:Green]**.

Registering a Picture Style



You can select a base Picture Style such as **[Portrait]** or **[Landscape]**, adjust its parameters as desired and register it under **[User Def. 1]**, **[User Def. 2]**, or **[User Def. 3]**. Useful when you want to preset multiple Picture Styles with different settings.

Picture Styles that you have registered on the camera using EOS Utility (EOS software) can also be modified here.

1 Select [Picture Style].

- Under the **[P]** tab, select **[Picture Style]**, then press **<SET>**.
- ➔ The Picture Style selection screen will appear.

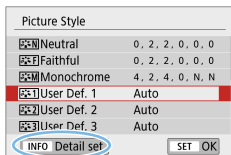

2 Select [User Def.].

- Select **[User Def. *]**, then press the **<INFO>** button.

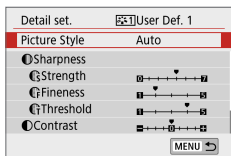

3 Press <SET>.

- With **[Picture Style]** selected, press **<SET>**.

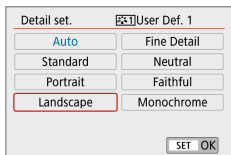

4 Select the base Picture Style.

- Select the base Picture Style, then press **<SET>**.
- To adjust the parameters of a Picture Style registered to the camera with EOS Utility (EOS software), select the Picture Style here.

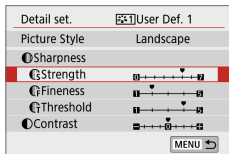

5 Select a parameter.

- Select the parameter (such as **[Strength]** of **[Sharpness]**) to be set, then press **<SET>**.

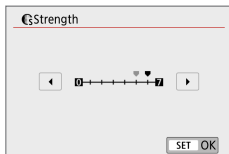

6 Set the parameter.

- Press the **<<<>>>** keys to adjust the effect of the parameter, then press **<SET>**.
For details, see “Customizing a Picture Style” (124).
 - Press the **<MENU>** button to register the adjusted parameter settings. The Picture Style selection screen will then reappear.
- ➔ The base Picture Style will be indicated on the right of **[User Def. *]**.

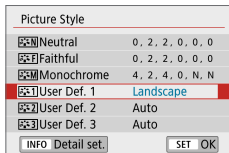

- If a Picture Style is already registered under **[User Def. *]**, changing the base Picture Style in step 4 will clear the parameter settings of the previously registered User Defined Picture Style.
- If you perform **[Clear all camera settings]** under **[Y: Clear settings]** (271), all the **[User Def. *]** styles and settings will revert to their defaults. Any Picture Style registered via EOS Utility (EOS software) will have only its modified parameters reverted to the default setting.



- To shoot with a registered Picture Style, follow step 2 on page 121 to select **[User Def. *]**, then shoot.
- Regarding the procedure to register a Picture Style file to the camera, refer to the EOS Utility Instruction Manual.

Matching the Light Source



White balance (WB) is for making the white areas look white. Normally, the Auto [**AWB**] (Ambience priority) or [**AWB w**] (White priority) setting will obtain the correct white balance. If natural-looking colors cannot be obtained with Auto, you can select the white balance to match the light source or set it manually by shooting a white object.

In Basic Zone modes, [**AWB**] (Ambience priority) is set automatically. (In the <P> mode, [**AWB w**] (White priority) is set.)

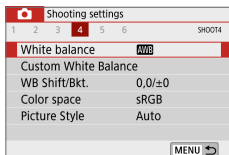

1 Select [White balance].

- Under the [**AWB**] tab, select [**White balance**], then press <SET>.
- ➔ [**White balance**] will appear.

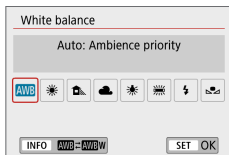

2 Select a white balance setting.

- Select the desired setting, then press <SET>.
- The “Approx. ****K” (K: Kelvin) displayed for the white balance settings <Sun>, <House>, <Cloud>, <Sun with rays> or <Snow> is the respective color temperature to be set.

White Balance

To the human eye, a white object looks white regardless of the type of lighting. With a digital camera, the white for color correction basis is decided depending on the color temperature of the illumination, and then the color is adjusted with software to make the white areas look white. With this function, you can take the pictures with natural color tones.

Auto White Balance

With **[AWB]** (Ambience priority), you can increase the intensity of the image's warm color cast when shooting a tungsten-light scene. If you select **[AWB w]** (White priority), you can reduce the intensity of the image's warm color cast. If you want to match the Auto white balance of previous EOS DIGITAL camera models, select **[AWB]** (Ambience priority).

1 Select **[White balance]**.

- Under the **[📷]** tab, select **[White balance]**, then press <SET>.

➔ **[White balance]** will appear.

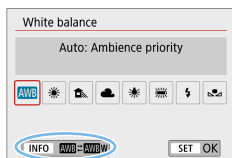

2 Select **[AWB]**.

- With **[AWB]** selected, press the <INFO> button.

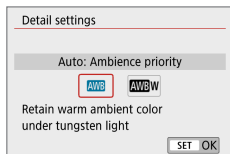

3 Select the desired item.

- Select **[Auto: Ambience priority]** or **[Auto: White priority]**, then press <SET>.

[AWB] : Auto: Ambience priority

[AWB w] : Auto: White priority



Cautions for Setting **[AWB w]** (White priority)

- The warm color cast of subjects may fade.
- When multiple light sources are included on the screen, the warm color cast of the picture may not be reduced.
- When using flash, the color tone will be the same as with **[AWB]** (Ambience priority).

Custom White Balance

With custom white balance, you can set the white balance for the specific light source of the shooting location. Make sure to perform this procedure under the light source at the actual location of the shoot.



1 Shoot a white object.

- Look through the viewfinder and aim the entire dotted line box (shown in the illustration) over a plain, white object.
- Focus manually and shoot with the standard exposure set for the white object.
- You can use any of the white balance settings.

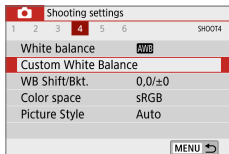

2 Select [Custom White Balance].

- Under the [CAMERA] tab, select [Custom White Balance], then press <SET>.
- ➔ The custom white balance selection screen will appear.



3 Import the white balance data.

- Select the image captured in step 1, then press <SET>.
- ➔ On the dialog screen that appears, select [OK], and the data will be imported.

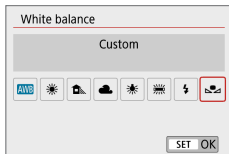

4 Select [] (**Custom**).

- Under the [] tab, select [**White balance**], then press <SET>.
- Select [] (**Custom**), then press <SET>.



- If the exposure obtained in step 1 differs greatly from the standard exposure, a correct white balance may not be obtained.
- In step 3, the following images cannot be selected: Images captured with the Picture Style set to [**Monochrome**] (121), images shot with a Creative filter, images processed with a Creative filter after shooting, cropped images, and images shot with another camera.

Adjusting the Color Tone for the Light Source



You can correct the white balance that is set. This adjustment will have the same effect as using a commercially-available color temperature conversion filter or color compensating filter. Each color can be corrected to one of nine levels.

This function is for advanced users, particularly for those users who understand the use of color temperature conversion and color compensating filters and their effects.

White Balance Correction

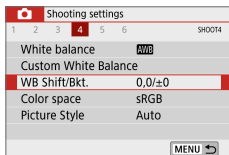

1 Select [WB Shift/Bkt.].

- Under the [CAMERA] tab, select [WB Shift/Bkt.], then press <SET>.
- The WB correction/WB bracketing screen will appear.



2 Set the white balance correction.

- Press the <▲> <▼> or <◀> <▶> keys to move the "■" mark to the appropriate position.
- B is for blue, A for amber, M for magenta, and G for green. The image's color balance will be adjusted toward the color in the direction of the move.
- On the right of the screen, "Shift" indicates the direction and correction amount, respectively.
- Pressing the <⏏> button will cancel all the [WB Shift/Bkt.] settings.
- Press <SET> to exit the setting and return to the menu.

Sample setting: A2, G1

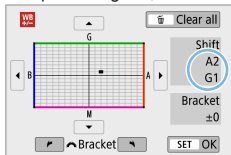



- You can set the camera to display $\langle ! \rangle$ in the viewfinder and on the LCD monitor for when white balance correction is set (📖450).
- One level of the blue/amber correction is equivalent to approx. 5 mireds of a color temperature conversion filter. (Mired: Unit of measure for color temperature used to indicate values such as the density of a color temperature conversion filter.)

White Balance Auto Bracketing

With just one shot, three images with different color tones can be recorded simultaneously. Based on the color temperature of the current white balance setting, the image will be bracketed with a blue/amber bias and magenta/green bias. This function is called white balance bracketing (WB Bkt.). White balance bracketing is possible up to ± 3 levels in single-level increments.



B/A bias ± 3 levels

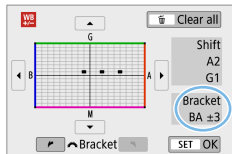

Set the white balance bracketing amount.

- In step 2 for “White Balance Correction” (📖133), when you turn the $\langle \text{dial} \rangle$ dial, the “■” mark on the screen will change to “■ ■ ■” (3 points). Turning the dial clockwise sets the B/A bracketing, and turning it counterclockwise sets the M/G bracketing.
- ➔ On the right, “**Bracket**” indicates the bracketing direction and correction amount.
- Pressing the $\langle \text{cancel} \rangle$ button will cancel all the [WB Shift/Bkt.] settings.
- Press $\langle \text{SET} \rangle$ to exit the setting and return to the menu.

Bracketing Sequence

The images will be bracketed in the following sequence: 1. Standard white balance, 2. Blue (B) bias, and 3. Amber (A) bias, or 1. Standard white balance, 2. Magenta (M) bias, and 3. Green (G) bias.



- During white balance bracketing, the maximum burst will be lower and the number of possible shots will also decrease to approx. one-third the normal number.
- Since three images are recorded for one shot, it takes longer to record the image to the card.



- You can also set white balance correction and AEB together with white balance bracketing. If you set AEB in combination with white balance bracketing, a total of nine images will be recorded for a single shot.
- During Live View shooting, the white balance icon will blink.
- “**Bracket**” stands for bracketing.

Auto Correction of Brightness and Contrast



If the image comes out dark or the contrast is low, the brightness and contrast can be corrected automatically. This function is called Auto Lighting Optimizer. The default setting is **[Standard]**. With JPEG images, the correction is applied when the image is captured.

In Basic Zone modes, **[Standard]** is set automatically.

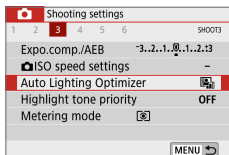

1 Select [Auto Lighting Optimizer].

- Under the [] tab, select **[Auto Lighting Optimizer]**, then press <SET>.

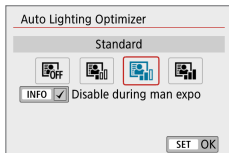

2 Select the setting.

- Select the desired setting, then press <SET>.

3 Take the picture.

- The image will be recorded with the brightness and contrast corrected as necessary.



- If [: **Highlight tone priority**] is set to **[Enable]** or **[Enhanced]**, **[Auto Lighting Optimizer]** will be set automatically to **[Disable]**.
- If a setting other than **[Disable]** is set and you use exposure compensation or flash exposure compensation to darken the exposure, the image may still come out bright. If you want a darker exposure, set this function to **[Disable]**.
- Depending on the shooting conditions, noise may increase.
- With **[High]**, maximum burst may be lower, and image recording to the card may take longer.



- In step 2, if you press the <INFO> button and remove the checkmark [✓] for **[Disable during man expo]** setting, the Auto Lighting Optimizer can also be set in the <M> mode.

Highlight Tone Priority



You can reduce overexposed, clipped highlights.

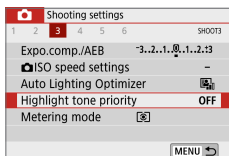

1 Select [Highlight tone priority].

- Under the [📷] tab, select [Highlight tone priority], then press <SET>.

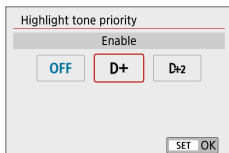

2 Set an option.

- [Enable]: Improves gradation in highlights. The gradation between the grays and highlights becomes smoother.
- [Enhanced]: Reduces overexposed highlights even more than [Enable], under some shooting conditions.

3 Take the picture.

- ➔ The image will be recorded with highlight tone priority applied.



- Noise may increase slightly.
- [Enhanced] is not available when recording movies.
- With [Enhanced], results in some scenes may not look as expected.

Setting Noise Reduction



High ISO Speed Noise Reduction

This function reduces the noise generated in the image. Although noise reduction is applied at all ISO speeds, it is particularly effective at high ISO speeds. When shooting at low ISO speeds, the noise in the darker parts of the image (shadow areas) can further be reduced. Change the setting to match the noise level.

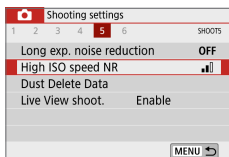

1 Select [High ISO speed NR].

- Under the [📷] tab, select [High ISO speed NR], then press <SET>.

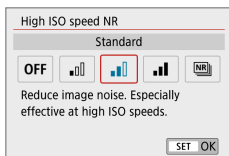

2 Set the level.

- Select the desired noise reduction level, then press <SET>.

- [NR]: **Multi Shot Noise Reduction**

Applies the noise reduction with higher image quality than [High]. For a single photo, four shots are taken continuously and aligned and merged automatically into a single JPEG image.

If the image quality is set to RAW or RAW+JPEG, you cannot set [Multi Shot Noise Reduction].

3 Take the picture.

- The image will be recorded with noise reduction applied.



- You can set the camera to display <!> in the viewfinder for when Multi Shot Noise Reduction is set (📖450).



When [Multi Shot Noise Reduction] is Set

- If there is significant misalignment in the image due to camera shake, the noise reduction effect may become smaller.
- If you are handholding the camera, keep it steady to prevent camera shake. Using a tripod is recommended.
- If you shoot a moving subject, the moving subject may leave afterimages.
- The image alignment may not function properly with repetitive patterns (lattice, stripes, etc.) or flat, single-tone images.
- If the subject's brightness changes as the four consecutive shots are taken, irregular exposure in the image may result.
- After shooting, it may take some time to record an image to the card after performing noise reduction and merging the images. During the image processing, "buSy" will be displayed in the viewfinder, and you cannot take another picture until the processing is complete.
- You cannot use AEB and white balance bracketing.
- If [: Long exp. noise reduction], AEB, or white balance bracketing is set, [Multi Shot Noise Reduction] cannot be set.
- Although flash photography is not possible, in low light, raising the flash beforehand is recommended, to enable firing of the AF-assist beam. However, the AF-assist beam will be emitted according to the setting of [: AF-assist beam firing].
- You cannot set [Multi Shot Noise Reduction] for bulb exposures.
- If you turn off the power, change the shooting mode to a Basic Zone mode, shoot a bulb exposure, or shoot a movie, the setting will automatically be changed to [Standard].
- [: Dust Delete Data] cannot be set.

Long Exposure Noise Reduction

Noise reduction is possible with images exposed for 1 sec. or longer.

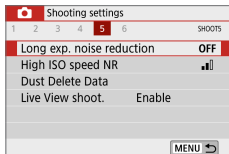

1 Select [Long exp. noise reduction].

- Under the [] tab, select [Long exp. noise reduction], then press <SET>.

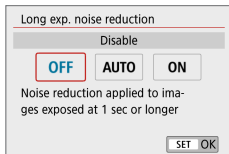

2 Set the desired setting.

- Select the desired setting, then press <SET>.

- **[Auto]**

For exposures of 1 sec. or longer, noise reduction is performed automatically if noise typical of long exposures is detected. This **[Auto]** setting is effective enough in most cases.

- **[Enable]**

Noise reduction is performed for all exposures of 1 sec. or longer. The **[Enable]** setting may reduce noise that cannot be detected with the **[Auto]** setting.

3 Take the picture.

- The image will be recorded with noise reduction applied.



- With **[Auto]** or **[Enable]** set, the noise reduction process after the picture is taken may take the same amount of time as that for the exposure. You cannot take another picture until the noise reduction process is complete.
- Images taken at ISO 1600 or higher may look grainier with the **[Enable]** setting than with the **[Disable]** or **[Auto]** setting.
- With **[Auto]** or **[Enable]** set, if a long exposure is used with the Live View image displayed, "BUSY" will be displayed during the noise reduction process. The Live View display will not appear until the noise reduction is complete. (You cannot take another picture.)

Correction of Lens Aberrations due to Optical Characteristics ☆

Vignetting, image distortion, and other issues may be caused by lens optical characteristics. The camera can compensate for these phenomena by using **[Lens aberration correction]**.

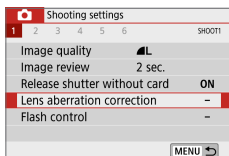

1 Select **[Lens aberration correction]**.

- Under the **[📷]** tab, select **[Lens aberration correction]**, then press **<SET>**.

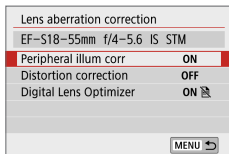

2 Select an item.

- Press the **<▲>** **<▼>** keys to select the item, then press **<SET>**.

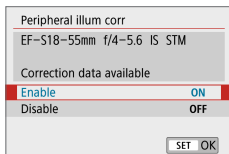

3 Select **[Enable]**.



- Confirm that the name of the attached lens and (except for diffraction correction) **[Correction data available]** are displayed.
- If **[Correction data not available]** or **[📷]** is displayed, see “Digital Lens Optimizer” (📖143).

4 Take the picture.

- The image captured will have lens aberration corrected.



Peripheral Illumination Correction

Vignetting (dark image corners) can be corrected.

-  • Depending on shooting conditions, noise may appear on the image periphery.
 - The higher the ISO speed, the lower the correction amount will be.
-
-  • The correction amount applied will be lower than the maximum correction amount that applied with Digital Photo Professional (EOS software).
 - Peripheral illumination is corrected automatically in Basic Zone modes when correction data is registered on the camera.

Distortion Correction

Distortion (image warping) can be corrected.

-  • To correct distortion, the camera captures a narrower image area than the area seen when shooting, which crops the image a little and slightly lowers the apparent resolution.
 - Setting distortion correction may change the angle of view slightly.
 - When you magnify images, distortion correction is not applied to the images displayed.
 - Images with distortion correction applied will not have the Dust Delete Data (📖274) appended.
 - AF point display during playback in viewfinder shooting may be slightly misaligned, due to distortion.
-
-  • Distortion is corrected automatically when <SCN> mode is set to <iii> and correction data is registered on the camera.

Digital Lens Optimizer

Various aberrations from lens optical characteristics can be corrected, along with diffraction and low-pass filter-induced loss of clarity.

If **[Correction data not available]** or  is displayed by **[Digital Lens Optimizer]**, you can use EOS Utility to add the lens correction data to the camera. For details, refer to the EOS Utility Instruction Manual.



- Depending on shooting conditions, noise may be intensified together with the effects of correction. Image edges may also be emphasized. Adjust Picture Style sharpness or set **[Digital Lens Optimizer]** to **[Disable]** as needed before shooting.
- The higher the ISO speed, the lower the correction amount will be.
- For movie recording, **[Digital Lens Optimizer]** will not appear. (Correction is not possible.)



- Enabling **[Digital Lens Optimizer]** corrects both chromatic aberration and diffraction, although these options are not displayed.
- Digital Lens Optimizer is applied automatically in Basic Zone modes when correction data is registered on the camera.

Chromatic Aberration Correction

Chromatic aberration (color fringing around subjects) can be corrected.



- **[Chromatic aberr corr]** is not displayed when **[Digital Lens Optimizer]** is enabled.

Diffraction Correction

Diffraction (loss of sharpness caused by the aperture) can be corrected.



- Depending on shooting conditions, noise may be intensified together with the effects of correction.
- The higher the ISO speed, the lower the correction amount will be.
- For movie shooting, **[Diffraction correction]** will not appear. (Correction is not possible.)



- With "Diffraction correction", degraded resolution due to the low-pass filter, etc. is corrected in addition to diffraction. Therefore, correction is effective even at an aperture close to the open aperture.
- **[Diffraction correction]** is not displayed when **[Digital Lens Optimizer]** is enabled.



General Cautions for Lens Aberration Correction

- Peripheral illumination correction, chromatic aberration correction, distortion correction, and diffraction correction cannot be applied to JPEG images already taken.
- When using a non-Canon lens, setting the corrections to **[Disable]** is recommended even if **[Correction data available]** is displayed.
- Magnifying the periphery of the image may display parts of the image that will not be recorded.
- The correction amount will be less (except for diffraction correction) if the lens used does not have distance information.



General Notes for Lens Aberration Correction

- The effect of the lens aberration correction varies depending on the lens used and shooting conditions. Also, the effect may be difficult to discern depending on the lens used, shooting conditions, etc.
- If the correction is difficult to discern, magnifying and checking the image after shooting is recommended.
- Corrections can be applied even when an extender or life-size converter is attached.
- If the correction data for the attached lens is not registered to the camera, the result will be the same as when the correction is set to **[Disable]** (except for diffraction correction).
- If necessary, refer to the EOS Utility Instruction Manual as well.

Setting the Color Reproduction Range



The range of reproducible colors is called “color space”. With this camera, you can set the color space for captured images to sRGB or Adobe RGB. For normal shooting, sRGB is recommended.

In Basic Zone modes, **[sRGB]** is set automatically.

1 Select [Color space].

- Under the [📷] tab, select [Color space], then press <SET>.

2 Set the desired color space.

- Select [sRGB] or [Adobe RGB], then press <SET>.

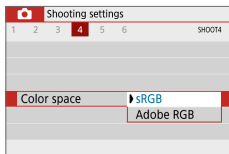

Adobe RGB

This color space is mainly used for commercial printing and other industrial uses. This setting is not recommended if you are not familiar with image processing, Adobe RGB, and Design rule for Camera File System 2.0 (Exif 2.21 or higher). The image will look very subdued in an sRGB computer environment and with printers not compliant to Design rule for Camera File System 2.0 (Exif 2.21 or higher). Post-processing of the image with computer software will therefore be required.



- If the still photo is shot in the Adobe RGB color space, the first character in the file name will be an underscore “_”.
- The ICC profile is not appended. For explanations about the ICC profile, refer to the Digital Photo Professional Instruction Manual.

Advanced Operations for Photographic Effects

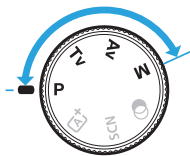



In Creative Zone modes, you can change various settings of the camera as you desire to obtain a wide variety of shooting results, by selecting the shutter speed and/or aperture, adjusting the exposure as you prefer, etc.

- After you press the shutter button halfway and let it go, the exposure settings will remain displayed in the viewfinder for approx. 4 sec. by the metering timer function.
- The ☆ icon at the upper right of the page title indicates that the function is available only in Creative Zone modes.

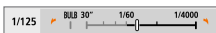
Main Dial Pointer



The pointer icon <  > displayed together with the shutter speed or aperture setting indicates that you can turn the <  > dial to adjust the respective setting.

Program AE (P Mode)

The camera automatically sets the shutter speed and aperture to suit the subject's brightness. This is called Program AE.

* <P> stands for Program.

* AE stands for Auto Exposure.

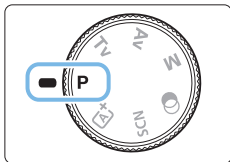

1 Set the Mode Dial to <P>.



2 Focus on the subject.

- Look through the viewfinder and aim the AF point over the subject. Then press the shutter button halfway.
- ➔ When focus is achieved, the dot inside the AF point achieving focus lights up briefly in red, and the focus indicator <●> on the viewfinder's bottom right will light up (in One-Shot AF mode).
- ➔ The shutter speed and aperture will be set automatically and displayed in the viewfinder.



3 Check the display.

- The standard exposure will be obtained as long as the shutter speed and aperture displays do not blink.

4 Take the picture.

- Compose the shot and press the shutter button completely.



- If a description of the shooting mode appears in step 1, press <SET> to hide it (p. 54).



Shooting Tips

- **Change the ISO speed. Use the built-in flash.**

To match the subject and ambient lighting level, you can change the ISO speed (📖 118) or use the built-in flash (📖 169).

- **Change the program using Program shift.**

After pressing the shutter button halfway, turn the <🌞> dial to change the shutter speed and aperture setting combination (program). Program shift is canceled automatically after the picture is taken. Program shift is not possible with flash.



- If the "30"" shutter speed and the lowest f/number blink, it indicates underexposure. Increase the ISO speed or use flash.



- If the "4000" shutter speed and the highest f/number blink, it indicates overexposure. Decrease the ISO speed.



Differences Between <P> and <A+> (Scene Intelligent Auto)

- In the <A+> mode, many functions, such as the AF operation and metering mode, are set automatically to prevent spoiled shots. The functions you can set are limited. On the other hand, with <P> mode, only the shutter speed and aperture are set automatically. You can freely set the AF operation, metering mode, and other functions.

Conveying the Subject's Movement (Tv Mode)

You can either freeze the action or create motion blur with the **<Tv>** (Shutter-priority AE) mode on the Mode Dial.

* **<Tv>** stands for Time value.

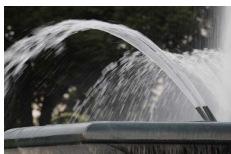

Blurred motion
(Slow shutter speed: 1/30 sec.)



Frozen motion
(Fast shutter speed: 1/2000 sec.)

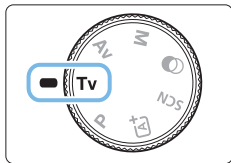

1 Set the Mode Dial to **<Tv>**.

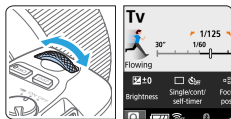

2 Set the desired shutter speed.

- See “Shooting Tips” (150) for advice on setting the shutter speed.
- Turning the  dial clockwise sets a faster shutter speed, and turning it counterclockwise sets a slower one.



3 Take the picture.

- When you focus and press the shutter button completely, the picture will be taken at the set shutter speed.



Shutter Speed Display

- The LCD monitor displays the shutter speed as a fraction. However, the viewfinder displays only the denominator. “0”5” indicates 0.5 sec. and “15”” is 15 sec.



Shooting Tips

- **To freeze the motion of a fast-moving subject**
Use a fast shutter speed such as 1/4000 sec. to 1/500 sec. according to the speed of the moving subject.
- **To blur a running child or animal and convey an impression of motion**
Use a medium shutter speed such as 1/250 sec. to 1/30 sec. Follow the moving subject through the viewfinder and press the shutter button to take the picture. If you use a telephoto lens, hold it steady to prevent camera shake.
- **To blur a flowing river or fountain**
Use a slow shutter speed of 1/30 sec. or slower. Use a tripod to prevent hand-held camera shake.
- **Set the shutter speed so that the aperture display does not blink.**

If you press the shutter button halfway and change the shutter speed with the aperture displayed, the aperture value will also change to maintain the same exposure (amount of light reaching the image sensor). In this operation, if the aperture value exceeds the adjustable range, it will blink to indicate that the standard exposure cannot be obtained.

If the exposure will be too dark, the maximum aperture (lowest f/ number) will blink. If this happens, turn the  dial counterclockwise to set a slower shutter speed or increase the ISO speed.

If the exposure will be too bright, the minimum aperture (highest f/ number) will blink. If this happens, turn the  dial clockwise to set a faster shutter speed or decrease the ISO speed.



Using the Built-in Flash

To obtain a correct flash exposure on the main subject, the flash output will be set automatically (autoflash) to match the automatically-set aperture.

Changing the Depth of Field (Av Mode)

To blur the background or to make everything near and far look sharp, set the Mode Dial to <Av> (Aperture-priority AE) to adjust the depth of field (range of acceptable focus).

* <Av> stands for Aperture value (the size of the lens diaphragm opening).

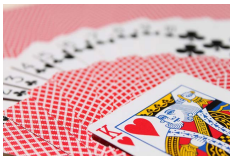

Blurred background
(With a low aperture f/number: f/5.6)



Sharp foreground and background
(With a high aperture f/number: f/32)

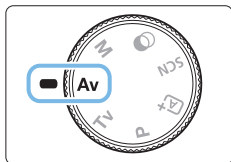

1 Set the Mode Dial to <Av>.

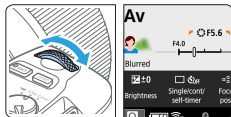

2 Set the desired aperture.

- The higher the f/number, the wider the depth of field where sharper focus is obtained in both the foreground and background.
- Turning the <aperture> dial clockwise sets a higher f/number (smaller aperture opening), and turning it counterclockwise sets a lower f/number (larger aperture opening).



3 Take the picture.

- When you focus and press the shutter button completely, the picture will be taken with the set aperture.



Aperture Value Display

- The higher the f/number, the smaller the aperture opening will be. The f/number displayed will differ depending on the lens. If no lens is attached to the camera, “00” will be displayed for the aperture.



Shooting Tips

- **When using an aperture with a high f/number or shooting in low light scenes, note that camera shake can occur.**
A higher aperture f/number will make the shutter speed slower. Under low light, the shutter speed can be as long as 30 sec. In such cases, increase the ISO speed and hold the camera steady or use a tripod.
- **The depth of field will vary depending not only on the aperture, but also on the lens and on the subject distance.**
Since wide-angle lenses have a wide depth of field (range of acceptable focus in front of and behind the point of focus), you need not set a high aperture f/number to obtain a sharp picture from the foreground to the background. On the other hand, a telephoto lens has a narrow depth of field.
And the closer the subject, the narrower the depth of field. A farther subject will have a wider depth of field.
- **Set the aperture so that the shutter speed display does not blink.**

If you press the shutter button halfway and change the aperture with the shutter speed displayed, the shutter speed will also change to maintain the same exposure (amount of light reaching the image sensor). In this operation, if the shutter speed exceeds the adjustable range, it will blink to indicate that the standard exposure cannot be obtained.

If the picture will be too dark, the “30” (30 sec.) shutter speed display will blink. If this happens, turn the <  > dial counterclockwise to set a lower f/number or increase the ISO speed.

If the picture will be too bright, the “4000” (1/4000 sec.) shutter speed display will blink. If this happens, turn the <  > dial clockwise to set a higher f/number or decrease the ISO speed.

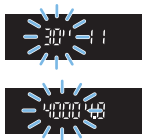

Using the Built-in Flash

To obtain a correct flash exposure, the flash output will be automatically controlled (autoflash) to match the set aperture. The shutter speed will be set automatically to match the brightness of the scene (📖176).

In low light, the main subject is exposed with the autoflash, and the background is exposed with a slow shutter speed set automatically. The picture comes out with the standard exposure for both the subject and background with a touch of the atmosphere (automatic slow-speed flash sync). If you are handholding the camera, keep it steady to prevent camera shake. Using a tripod is recommended to prevent camera shake.

Depth-of-Field Preview

The aperture opening (diaphragm) changes only at the moment when the picture is taken. Otherwise, the aperture remains fully open. Therefore, when you look at the scene through the viewfinder or on the LCD monitor, the depth of field will look narrow.

You can check the depth of field by pressing the <SET> or <DISP> button when they are configured as described below. The range in focus can be clearly seen on Live View images as you adjust the aperture value while holding down the <SET> or <DISP> button.

- In [**☛**: Custom Functions(C.Fn)], set [**Assign SET button**] to [**7:Depth-of-field preview**].
- In [**☛**: Custom Functions(C.Fn)], set [**DISP button function**] to [**1:Depth-of-field preview**].

Manual Exposure (M Mode)

You can set both the shutter speed and aperture manually as desired. While referring to the exposure level indicator in the viewfinder, you can set the exposure as desired. This method is called manual exposure.

* <M> stands for Manual.

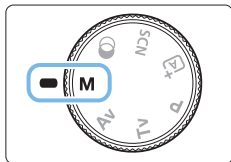

1 Set the Mode Dial to <M>.

2 Set the ISO speed (book 118).

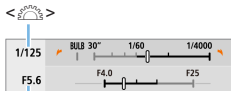

<Av/☒> + <☒/>

3 Set the shutter speed and aperture.

- To set the shutter speed, turn the <☒/> dial.
- To set the aperture, turn the <☒/> dial while holding down the <Av/☒> button.

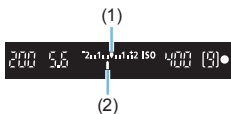

4 Focus on the subject.

- Press the shutter button halfway.
- ➔ The exposure setting will be displayed in the viewfinder.
- Check the exposure level mark <☒/> to see how far the current exposure level is from the standard exposure level.

(1) Standard exposure index

(2) Exposure level mark

5 Set the exposure and take the picture.

- Check the exposure level indicator and set the desired shutter speed and aperture.
- If the exposure level exceeds ± 2 stops from the standard exposure, the end of the exposure level indicator will display <◀> or <▶> in the viewfinder. (On the LCD monitor, if the exposure level exceeds ± 3 stops, <◀> or <▶> will be displayed.)



- The set exposure setting will not be maintained for movie shooting.

Exposure Compensation with ISO Auto

If the ISO speed is set to **[AUTO]** for manual exposure shooting, you can set exposure compensation (📖160) as follows:

- **[📷: Expo.comp./AEB]**
- **[5:Expo comp (hold btn, turn 🌞)]** with **[Assign SET button]** under **[🔧: Custom Functions(C.Fn)]** (📖452)
- Quick Control (📖57)



- If ISO Auto is set, the ISO speed setting will change to obtain the standard exposure with the set shutter speed and aperture. Therefore, you may not obtain the desired exposure effect. In such a case, set the exposure compensation.
- If flash is used when ISO Auto is set, exposure compensation will not be applied even if an exposure compensation amount is set.



- Under **[📷: Auto Lighting Optimizer]**, if the checkmark **[✓]** for **[Disable during man expo]** is removed, Auto Lighting Optimizer can be set even in the **<M>** mode (📖136).
- When ISO Auto is set, you can press the **<✳>** button to lock the ISO speed.
- If you press the **<✳>** button and recompose the shot, you can see the exposure level difference on the exposure level indicator compared to when the **<✳>** button was pressed.
- If exposure compensation (📖160) was applied in **<P>**, **<Tv>**, or **<Av>** mode, the exposure compensation amount already set will still be maintained when the shooting mode is switched to **<M>** with ISO Auto set.

Using the Built-in Flash

To obtain a correct flash exposure on the main subject, the flash output will be set automatically (autoflash) to match the manually-set aperture. Note that the range of settable shutter speed will be limited within 1/200 sec. to 30 sec. or to bulb.

BULB: Long (Bulb) Exposures

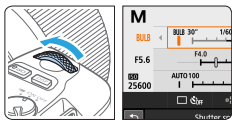

A bulb exposure keeps the shutter open for as long as you hold down the shutter button. It can be used to shoot fireworks and other subjects requiring long exposures.

In step 3 on page 155, turn the  dial to the left to set <BULB>. The elapsed exposure time (1) will be displayed on the LCD monitor.



- Do not point the camera toward an intense light source, such as the sun or an intense artificial light source. Doing so may damage the image sensor or the camera's internal components.
- Since long bulb exposures produce more noise than usual, the image may look slightly grainy.
- If ISO Auto is set, the ISO speed will be ISO 400.
- When shooting bulb exposures, if you use both the self-timer and mirror lockup, keep pressing the shutter button completely (for self-timer delay time + bulb exposure time). If you let go of the shutter button during the self-timer countdown, there will be a shutter-release sound, but no picture will be taken.



- You can reduce the noise due to long exposures by setting [📷: Long exp. noise reduction] to [Auto] or [Enable] (📖139).
- For bulb exposures, using a tripod and a remote switch (sold separately, 📖463) is recommended.
- You can also use Wireless Remote Control BR-E1 (sold separately, 📖463) for bulb exposures. When you press the BR-E1's release button (transmit button), the bulb exposure will start immediately or 2 sec. later. Press the button again to stop the bulb exposure.
- You can turn off the elapsed exposure time display by pressing the <INFO> button.

Changing the Metering Mode



Four methods (metering modes) to measure the subject's brightness are provided. Normally, evaluative metering is recommended. In Basic Zone modes, evaluative metering is set automatically. (In the <SCN: [M]> and <P: [M]> modes, center-weighted average metering is set.)

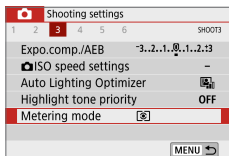

1 Select [Metering mode].

- Under the [M] tab, select [Metering mode], then press <SET>.

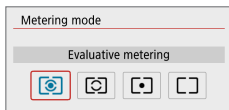

2 Set the metering mode.

- Select the desired metering mode, then press <SET>.

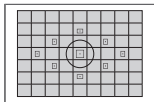

Evaluative metering

General-purpose metering mode suited even for backlit subjects. The camera adjusts the exposure automatically to suit the scene.

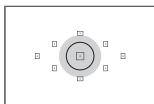

Partial metering

Effective where there are much brighter lights around the subject due to backlight, etc. The gray area in the left figure is approximately where the brightness is metered to obtain the standard exposure.

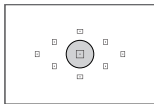

Spot metering



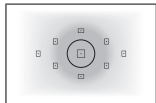

Effective when metering a specific part of the subject or scene. The gray area in the left figure is approximately where the brightness is metered to obtain the standard exposure. This metering mode is for advanced users.



Center-weighted average metering

The metering is averaged for the entire scene with the screen center weighted more heavily. This metering mode is for advanced experts.



- With  (Evaluative metering), the exposure setting will be locked when you press the shutter button halfway and focus is achieved. In the  (Partial metering),  (Spot metering), and  (Center-weighted average metering) modes, the exposure is set at the moment the picture is taken. (Pressing the shutter button halfway does not lock the exposure.)

Setting the Desired Exposure Compensation



Set exposure compensation if the results of shooting without using the flash are not as bright as expected. This feature can be used in Creative Zone modes (except <M>). You can set the exposure compensation up to ± 5 stops* in 1/3-stop increments.

If the <M> mode and ISO Auto are both set, see page 156 to set the exposure compensation.

- * In Live View shooting/movie shooting, or when [📷: Shooting screen] is set to [Guided], exposure compensation can be set up to ± 3 stops.

Increased exposure for a brighter image

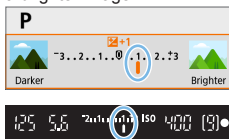

Decreased exposure for a darker image



1 Check the exposure level indicator.

- Press the shutter button halfway and check the exposure level indicator in the viewfinder or on the LCD monitor.

2 Set the compensation amount.

- If the exposure is too dark, turn the <☀> dial clockwise while holding down the <Av/☑> button (for increased exposure).
- If the exposure is too bright, turn the <☀> dial counterclockwise while holding down the <Av/☑> button (for decreased exposure).

3 Take the picture.

- To cancel the exposure compensation, set the compensation amount back to <0>.



- If [📷: Auto Lighting Optimizer] (📖 136) is set to any setting other than [Disable], the image may still look bright even if a decreased exposure compensation for a darker image is set.

- The set exposure compensation level will not be applied to movie shooting.



- When you set the power switch to <OFF>, the exposure compensation setting will be canceled.
- The exposure compensation amount displayed in the viewfinder goes up to only ± 2 stops. If the exposure compensation amount exceeds ± 2 stops, the end of the exposure level indicator will display <◀> or <▶>.
- If you want to set exposure compensation exceeding ± 2 stops, setting it with [**☑**: **Expo.comp./AEB**] (📖 162) is recommended.

Auto Exposure Bracketing



This feature takes exposure compensation a step further by varying the exposure automatically in the range of ± 2 stops in 1/3-stop increments with three shots as shown below. You can then choose the best exposure. This is called AEB (Auto Exposure Bracketing).



Standard exposure

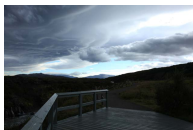

Darker exposure
(Decreased exposure)



Brighter exposure
(Increased exposure)

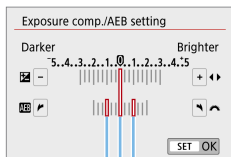
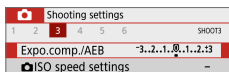

(1)



1 Select [Expo.comp./AEB].

- Under the [] tab, select [Expo.comp./AEB], then press <SET>.

2 Set the AEB range.

- Turn the <  > dial to set the AEB range (1).
- Press the < ◀ > < ▶ > keys to set the exposure compensation amount. If AEB is combined with exposure compensation, AEB will be applied centering on level of exposure compensation.
- Press <SET> to set it.
- ➔ When you press the shutter button halfway, the AEB range will be displayed in the viewfinder.

3 Take the picture.

- Focus and press the shutter button completely, and the shots will be taken in the sequence of standard exposure, decreased exposure, and increased exposure.

Canceling AEB

- Follow steps 1 and 2 to turn off the AEB range display (set to 0).
- The AEB setting will also be canceled automatically if the power switch is set to <OFF>, flash recharging is complete, etc.

Shooting Tips

● Using AEB with continuous shooting

If you set the drive mode to <C> or <C/S> (📖112) and press the shutter button completely, the three bracketed shots will be taken consecutively in the sequence of standard exposure, decreased exposure, and increased exposure, and then the camera will automatically stop shooting.

● Using AEB with single shooting (□/□S)

Press the shutter button three times to take the three bracketed shots. The shots will be taken in the sequence of standard exposure, decreased exposure, and increased exposure.

● Using AEB with the self-timer or a remote controller (sold separately)

With the self-timer (<⌚10> <⌚2>), Wireless Remote Control BR-E1 <⌚> or Remote Switch RS-60E3, you can take three consecutive shots after a 10-sec. or 2-sec. delay. With <⌚c> (📖206) set, the number of consecutive shots will be three times the number set.



- During AEB, <✳> and AEB range in the viewfinder will blink.
- AEB cannot be used with flash, when **[Multi Shot Noise Reduction]** is set, for shooting with a Creative filter, or with bulb exposures.
- If **[📷: Auto Lighting Optimizer]** (📖136) is set to any setting other than **[Disable]**, the effect of AEB may be reduced.

Locking the Exposure



You can lock the exposure when you want to set the focus and exposure separately or when you are to take multiple shots at the same exposure setting. Press the <★> button to lock the exposure, then recompose and take the picture. This is called AE lock. It is effective for shooting backlit subjects, etc.

1 Focus on the subject.

- Press the shutter button halfway.
- ➔ The exposure setting will be displayed.

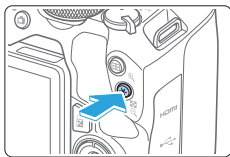

2 Pressing the <★> button.

- ➔ The <★> icon lights up in the viewfinder to indicate that the exposure setting is locked (AE lock).
- Each time you press the <★> button, the current exposure setting is locked.

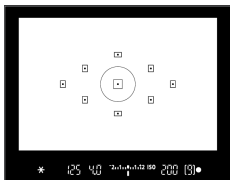

3 Recompose and take the picture.

- When you are to take more pictures while maintaining the AE lock, keep holding down the <★> button and press the shutter button to take another picture.

AE Lock Effects

Metering Mode (158)	AF Point Selection Method (108)	
	Automatic Selection	Manual Selection
	AE lock is applied at the AF point that achieved focus.	AE lock is applied at the selected AF point.
	AE lock is applied at the center AF point.	

* When the lens's focus mode switch is set to <MF>, AE lock is implemented with the exposure weighting centered on the center AF point.



- AE lock is not possible with bulb exposures.

Mirror Lockup to Reduce Camera Vibration Blur



You can use the mirror lockup function to prevent the disturbing mechanical vibrations (mirror shock) when shooting with super telephoto lenses or shooting close-ups (macro photography).

Mirror lockup is enabled by setting [Mirror lockup] to [1:Enable] in [☛: Custom Functions(C.Fn)] (📖449).

1 Focus on the subject, then press the shutter button completely.

→ The mirror will swing up.

2 Press the shutter button completely again.

→ The picture is taken and the mirror goes back down.

● After taking the picture, set **[Mirror lockup]** to **[0:Disable]**.



Shooting Tips

● Using the self-timer <📷10>, <📷2> with mirror lockup

When you press the shutter button completely, the mirror locks up. The picture will be then taken 10 sec. or 2 sec. later.

● Remote control shooting

Since you do not touch the camera when the picture is taken, remote control shooting together with mirror lockup can further reduce the camera vibration blur (📖463).

With Wireless Remote Control BR-E1 (sold separately) set to the 2-sec. delay, press the release button to lock up the mirror, and the picture will be taken 2 sec. after the mirror lockup.

With Remote Switch RS-60E3 (sold separately), press the release button completely to lock up the mirror, and press it completely again to take the picture.



- Do not point the camera toward an intense light source, such as the sun or an intense artificial light source. Doing so may damage the image sensor or the camera's internal components.
- In very bright light, such as at the beach or a ski slope on a sunny day, take the picture promptly after mirror lockup is stabilized.
- When shooting with mirror lockup, if you use both the self-timer and bulb exposures, keep pressing the shutter button completely (for self-timer delay time + bulb exposure time). If you let go of the shutter button during the self-timer countdown, there will be a shutter-release sound, but no picture will be taken.
- During mirror lockup, shooting function settings, menu operations, etc. are disabled.



- Even if you set the drive mode to , , or , the camera will still shoot in single shooting mode.
- When [📷: High ISO speed NR] is set to [Multi Shot Noise Reduction], four consecutive shots will be taken for a single picture regardless of the [Mirror lockup] setting.
- If approx. 30 sec. elapse after the mirror has locked up, it will go back down automatically. Pressing the shutter button completely locks up the mirror again.
- When shooting with mirror lockup, using a tripod and Wireless Remote Control BR-E1 (sold separately, 463) or Remote Switch RS-60E3 (sold separately, 463) is recommended.

AF-Assist Beam Settings

Specify firing of the AF-assist beam from the camera's built-in flash or an EOS Speedlite.

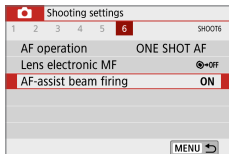

1 Select [AF-assist beam firing].

- Under the [CAMERA] tab, select [AF-assist beam firing], then press <SET>.

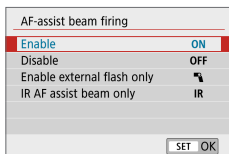

2 Select an item.

- Press the <▲> <▼> keys to select the item, then press <SET>.

- [ON] Enable**

The AF-assist beam will be emitted when necessary.

Raise the flash to emit the AF-assist beam from the built-in flash.

- [OFF] Disable**

The AF-assist beam will not be emitted. Set if you prefer not to emit the AF-assist beam.

- [IR] Enable external flash only**

If an external Speedlite is attached, it will emit the AF-assist beam when necessary.

- [IR] IR AF assist beam only**

Enables infrared AF-assist beam emitting by external Speedlites equipped with this feature, when these flash units are attached.



- Raising the flash in advance and setting [AF-assist beam firing] to [Enable] is recommended in <AF+>, <SCN>, or <Q> mode.
- No AF-assist beam is emitted by external Speedlites with their [AF-assist beam firing] Custom Function set to [Disable].

Flash Photography

This chapter describes how to shoot with built-in flash and external Speedlites (EL/EX-series, sold separately), and how to set flash settings on the camera's menu screen.

-  AEB cannot be used in flash photography.

Using the Built-in Flash

In indoor, low light, or backlit conditions in daylight, just raise the built-in flash and press the shutter button to easily take beautiful pictures. In the <P> mode, the shutter speed (1/60 sec. - 1/200 sec.) will be set automatically to prevent camera shake.

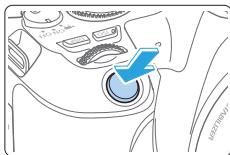
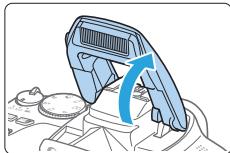

1 Raise the flash with your fingers.

- In Creative Zone modes, shooting with flash is possible whenever the flash is raised.
- While the flash is recharging, “buSy” is displayed in the viewfinder, and [BUSY] is displayed on the LCD monitor.

2 Press the shutter button halfway.

- In the bottom left of the viewfinder, check that the <L> icon is displayed.

3 Take the picture.

- When focus is achieved and you press the shutter button completely, the flash will fire at all times.



- Before raising the flash, remove any accessories attached to the hot shoe.



Shooting Tips

- **In bright light, decrease the ISO speed.**

If the exposure setting in the viewfinder blinks, decrease the ISO speed.

- **Detach the lens hood. Do not get too close to the subject.**

If the lens has a hood attached or you are too close to the subject, the bottom of the picture may look dark due to the obstructed flash light.

For important shots, play back the image and check to make sure the picture does not look unnaturally dark at the bottom part.



Flash Exposure Compensation

Set the flash exposure compensation if the brightness of the subject does not come out as desired (so you want to adjust the flash output) in flash photography. You can set the flash exposure compensation up to ± 2 stops in 1/3-stop increments.

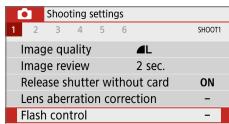

1 Select [Flash control].

- Under the [] tab, select [Flash control], then press <SET>.

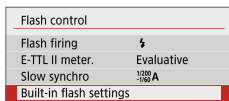

2 Select [Built-in flash settings].

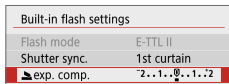

3 Select [exp. comp.].

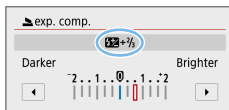



4 Set the compensation amount.

- If the exposure is too dark, press the <▶> key (for increased exposure). If the exposure is too bright, press the <◀> key (for decreased exposure).
- ➔ When you press the shutter button halfway, the icon will appear in the viewfinder.
- After taking the picture, cancel the flash exposure compensation by setting it back to 0.





- If [: **Auto Lighting Optimizer**] ( 136) is set to any setting other than **[Disable]**, the image may still look bright even if a decreased flash exposure compensation is set.
- If flash exposure compensation is set with an external Speedlite (sold separately,  174), you cannot set the flash exposure compensation with the camera (Quick Control or External flash function settings). If it is set with both the camera and external Speedlite, the Speedlite's setting overrides the camera's.



- The compensation amount will be retained even after you set the power switch to <OFF>.



Locking the Flash Exposure (FE lock)

If the subject is at the edge of the screen, and you use flash, the subject may turn out to be too bright or dark depending on the background, etc. Use FE lock in such a case. After setting the flash output for the appropriate subject brightness, you can recompose (put the subject toward the side) and shoot. This feature can also be used with a Canon EL/EX-series Speedlite.

* FE stands for Flash Exposure.

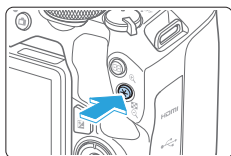
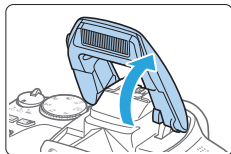

1 Raise the flash with your fingers.

- Press the shutter button halfway and look in the viewfinder to check that the icon is lit.

2 Focus on the subject.

3 Press the button.

- Aim the viewfinder center over the subject where you want to lock the flash exposure, then press the button.
- ➔ The flash will fire a preflash and the required flash output is calculated and retained in memory.
- ➔ In the viewfinder, "FEL" is displayed for a moment and will light up.
- Each time you press the button, a preflash is fired and the required flash output is calculated and retained in memory.

4 Take the picture.

- Compose the shot and press the shutter button completely.
- ➔ The flash is fired, and the picture is taken.



- If the subject is too far away and the captured image comes out dark, the icon will blink. Move closer to the subject and repeat steps 2 to 4.
- FE lock is not possible during Live View shooting.

Using an External Speedlite

EOS-dedicated, EL/EX-series Speedlites

Using an EL/EX-series Speedlite (sold separately) makes flash photography easy.

For operation procedures, refer to the EL/EX-series Speedlite's Instruction Manual.



- Functions are limited when using EX series Speedlites that are not compatible with flash function settings.



- Non-EL/EX series Canon Speedlites will not fire.
- If the camera is used with a flash unit or flash accessory dedicated to another camera brand, the camera not only may not operate properly, but malfunction may result.

Setting the Flash Function

With the built-in flash or an EL/EX-series, external Speedlite compatible with the flash function settings, you can use the camera's menu screen to set flash functions and the external Speedlite's Custom Functions.

If you use an external Speedlite, attach the Speedlite to the camera and turn on the Speedlite before setting the flash functions.

For details on the external Speedlite's flash functions, refer to the Speedlite's instruction manual.

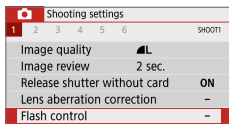

1 Select [Flash control].

- Under the [📷] tab, select [Flash control], then press <SET>.

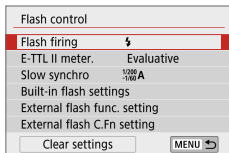

2 Select an item.

- Select the menu option to be set, then press <SET>.

Flash Firing

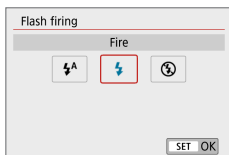

Set to [⚡^A] (in Basic Zone modes or **P** mode) to have the flash fire automatically, based on shooting conditions.

Set to [⚡] to have the flash always fire when you shoot.

Select [Ⓞ] (in Creative Zone modes) to keep the flash off, or if you will use the AF-assist beam.



- Even if [Flash firing] is set to [Ⓞ], if focus is difficult to achieve in low light, the flash may still fire a series of flashes ("AF-Assist Beam Settings" (167)). To prevent the built-in flash from firing, push it down with your fingers.



E-TTL II Flash Metering

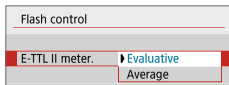

For normal flash exposures, set it to **[Evaluative]**. If **[Average]** is set, the flash exposure will be averaged for the entire metered scene. Depending on the scene, flash exposure compensation may be necessary. This setting is for advanced users.



Slow Synchro

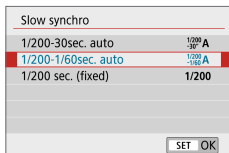

You can set the flash-sync speed for flash photography in **<Av>** or **<P>** mode.

- **[^{1/200}/₋₃₀ A] 1/200-30sec. auto**

The flash sync speed is set automatically within a range of 1/200 sec. to 30 sec. to suit the scene's brightness. Slow-sync shooting is used under some shooting conditions, in low-light locations, and shutter speed is automatically lowered.

- **[^{1/200}/_{-1/60} A] 1/200-1/60sec. auto**

Prevents a slow shutter speed from being set in low-light conditions. It is effective for preventing subject blur and camera shake. However, while the subject will be properly exposed with the flash, the background may come out dark.

- **[1/200] 1/200 sec. (fixed)**

The flash sync speed is fixed at 1/200 sec. This more effectively prevents subject blur and camera shake than with **[1/200-1/60sec. auto]**. However, in low light, the subject's background will come out darker than with **[1/200-1/60sec. auto]**.



- To use slow-sync shooting, set to **[1/200-30sec. auto]**.
- High-speed sync is not available in **<Av>** or **<P>** mode when set to **[1/200 sec. (fixed)]**.

[Built-in flash settings] and [External flash func. setting] ☆

You can set the functions in the table below. The functions displayed under **[External flash func. setting]** vary depending on the Speedlite model.

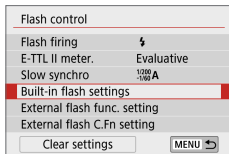

- Select **[Built-in flash settings]** or **[External flash func. setting]**.
- ➔ The flash function setting screen will be displayed. With **[Built-in flash settings]**, only the highlighted functions can be selected and set.

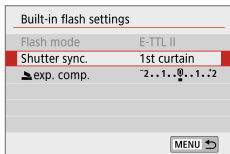

[Built-in flash settings]

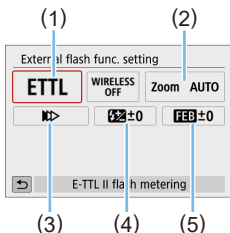

[External flash func. setting]

- (1) Flash mode
- (2) Flash zoom
(Flash coverage)
- (3) Shutter
synchronization
- (4) Flash exposure
compensation
- (5) Flash exposure
bracketing

Main Functions for [Built-in flash settings] and [External flash func. setting]

Function	[Built-in flash settings]	[External flash func. setting]	Page
	Normal Firing		
Flash mode		○	178
Shutter synchronization	○	○	178
Flash exposure bracketing*		○	
Flash exposure compensation	○	○	171
Firing ratio control		○	
Sender flash firing		○	
Flash zoom*		○	

* For **[Flash exposure bracketing]** and **[Flash zoom]**, refer to the instruction manual of a Speedlite compatible with the functions.

- **Flash mode**

When using an external Speedlite, you can select the flash mode to suit your desired photographic effects.

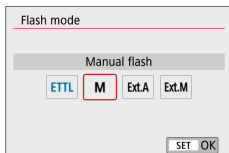
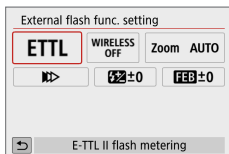

- **[E-TTL II flash metering]** is the standard mode of EL/EX-series Speedlites for automatic flash photography.
- **[Manual flash]** is the mode for advanced users who want to set the **[Flash output]** (1/1 to 1/128) themselves.
- Regarding other flash modes, refer to the instruction manual of a Speedlite compatible with the respective flash mode.

- **Shutter synchronization**

Normally, set this to **[First-curtain synchronization]** so that the flash fires immediately after the exposure starts.

If **[Second-curtain synchronization]** is set, the flash will be fired right before the shutter closes. When this is combined with a slow shutter speed, you can create a trail of light such as from car headlights at night with a more natural feel. When second-curtain synchronization is set together with **[E-TTL II flash metering]**, the flash will be fired twice in a row: once when you press the shutter button completely and once right before the end of the exposure. Also, if the shutter speed is 1/100 sec. or faster, first-curtain synchronization will be applied automatically. If an external Speedlite is attached, you can also select **[High-speed synchronization]** (⚡_H). For details, refer to the Speedlite's instruction manual.

- **Flash exposure compensation**

For details, see “Flash Exposure Compensation” (📖 171).

Setting the External Speedlite Custom Functions



The Custom Functions displayed under **[External flash C.Fn setting]** vary depending on the Speedlite model.

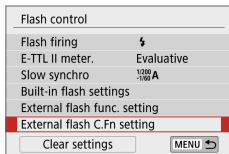

1 Display the Custom Function.

- With the camera ready to shoot with an external Speedlite, select **[External flash C.Fn setting]**, then press **<SET>**.

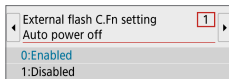

2 Set the Custom Function.

- Press the **<◀>** **<▶>** keys to select the function number, then set the function. The procedure is the same as setting the camera's Custom Functions (446).

Clear All Settings to Default

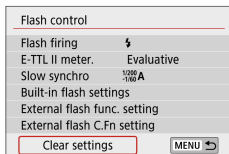

1 Select **[Clear settings]**.

- Under the **[📷: Flash control]** tab, select **[Clear settings]**, then press **<SET>**.

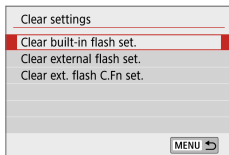

2 Select the settings to be cleared.

- Select **[Clear built-in flash set.]**, **[Clear external flash set.]**, or **[Clear ext. flash C.Fn set.]**, then press **<SET>**.
- When you select **[OK]**, the respective flash settings will be cleared.



- The Speedlite's Personal Function (P.Fn) cannot be set or canceled on the camera's **[Flash control]** screen. Set it directly on the Speedlite.

Shooting with the LCD Monitor (Live View Shooting)

You can shoot while viewing the image on the camera's LCD monitor. This is called "Live View shooting".

- If you handhold the camera and shoot while viewing the LCD monitor, camera shake may cause blurred images. Using a tripod is recommended in such cases.





Remote Live View Shooting

- With EOS Utility (EOS software,  482) installed on your computer, you can connect the camera to the computer and shoot remotely while viewing the computer screen. For details, refer to the EOS Utility Instruction Manual.

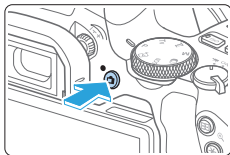
Shooting with the LCD Monitor



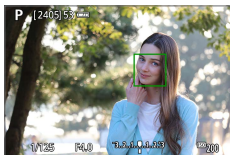

1 Display the Live View image.

- Press the  button.
- ➔ The Live View image will appear on the LCD monitor. In the  mode, the scene icon for the scene detected by the camera is displayed on the upper left of the screen ( 186).
- The Live View image will be displayed in the brightness level closely matching that of the actual image to be captured.



2 Focus on the subject.

- When you press the shutter button halfway, the camera will focus with the current AF method ( 197).
- You can also tap on the screen to select the face or subject ( 208).

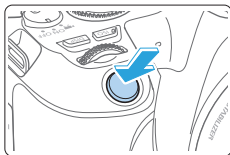

3 Take the picture.

- Press the shutter button completely.
- ➔ The picture is taken and the captured image is displayed on the LCD monitor.
- ➔ When the playback display ends, the camera will return to Live View shooting automatically.
- Press the  button to exit the Live View shooting.



- The image's field of view is approx. 100% (with image-recording quality set to JPEG and aspect ratio set to 3:2).
- You can check the depth of field in Creative Zone modes by pressing the <SET> or <DISP> button when they are configured as described below.
 - In [**Y**: Custom Functions(C.Fn)], set [**Assign SET button**] to [**7:Depth-of-field preview**].
 - In [**Y**: Custom Functions(C.Fn)], set [**DISP button function**] to [**1:Depth-of-field preview**].
- You can also use a Wireless Remote Control BR-E1 (sold separately) or Remote Switch RS-60E3 (sold separately) for Live View shooting (463).

Enabling Live View Shooting

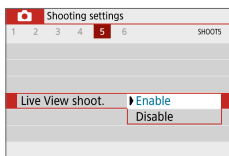

Set [**📷: Live View shoot.**] to [**Enable**].

Continuous Shooting Display

During Live View shooting, if you perform <> Continuous shooting with One-Shot AF, keep holding down the shutter button completely to display (play back) the captured images continuously. When the continuous shooting ends (shutter button is returned to halfway position), the Live View image will be displayed.



- Depending on the shooting conditions such as when shooting with flash or shooting long exposures, the captured images may not be displayed (played back) continuously.
- In the <**SCN**: > mode, Live View shooting is not possible.
- In the <**SCN**: > mode, the angle of view changes slightly in Live View shooting because distortion correction is applied.
- In the <**SCN**: > and < > modes, the image area will be smaller.
- For flash photography, the continuous shooting speed will become slower.
- Do not point the camera toward an intense light source, such as the sun or an intense artificial light source. Doing so may damage the image sensor or the camera's internal components.
- **General Live View Shooting Cautions are on 215 - 216.**



- When flash is used, there will be two shutter sounds, but only one shot will be taken. Also, the time it takes to take the picture after you press the shutter button completely will be longer than with viewfinder shooting.
- If the camera is not operated for a prolonged period, the power will turn off automatically after the time set in [**☛**: **Auto power off**] (📖261). If [**☛**: **Auto power off**] is set to [**Disable**], Live View shooting will end automatically after 30 min. (Camera power remains on.)
- With the HDMI cable, you can display the Live View image on a TV set (📖305). Note that no sound will be output. If the picture does not appear on the TV screen, check if the [**☛**: **Video system**] is correctly set to [**For NTSC**] or [**For PAL**] (depending on the video system of your TV set).

Information Display

- Each time you press the <INFO> button, the information display will change.

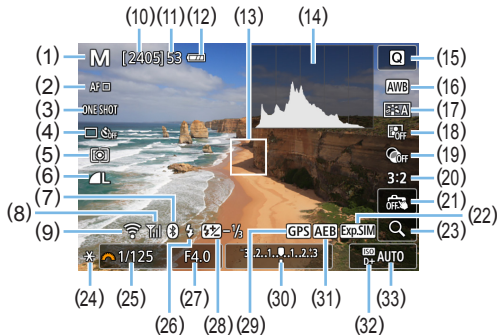

- | | |
|---|---|
| (1) Shooting mode | (18) Auto Lighting Optimizer |
| (2) AF method | (19) Creative filters |
| (3) AF operation | (20) Still image aspect ratio |
| (4) Drive mode | (21) Touch Shutter |
| (5) Metering mode | (22) Exposure simulation |
| (6) Image-recording quality | (23) Magnified view |
| (7) Bluetooth function | (24) AE lock |
| (8) Wi-Fi signal strength | (25) Shutter speed |
| (9) Wi-Fi function | (26) Flash-ready/Flash off |
| (10) Possible shots | (27) Aperture |
| (11) Maximum burst | (28) Flash exposure compensation |
| (12) Battery level | (29) GPS connection indicator |
| (13) AF point (1-point AF) | (30) Exposure level indicator/AEB range |
| (14) Histogram display | (31) AEB/FEB/Multi Shot Noise Reduction |
| (15) Quick Control | (32) Highlight tone priority |
| (16) White balance/White balance correction | (33) ISO speed |
| (17) Picture Style | |



- You can display the histogram by pressing the <INFO> button. However, the histogram is not displayed while pressing the shutter button completely.
- When <Exp.SIM> is displayed in white, it indicates that the Live View image is displayed at the brightness level closely matching that of the actual image to be captured.
- If <Exp.SIM> is blinking, it indicates that the Live View image is displayed at a brightness that differs from the actual shooting result because of low- or bright-light conditions. However, the actual image recorded will reflect the exposure setting. Note that the noise may be more noticeable than the actual image recorded.
- Exposure simulation is not performed in <SCN: [icon] > modes, when Multi Shot Noise Reduction is set, when flash is used, or when bulb exposure is used. The <Exp.SIM> icon and histogram will be displayed in gray. The image is displayed on the LCD monitor with standard brightness. Also, the histogram may not be properly displayed in low- or bright-light conditions.
- The <Exp.SIM> icon will also be displayed in gray in the <[icon]: [HDR] [HDR] [HDR] [HDR]> modes. The histogram will not be displayed.

Warnings:

Do not hold the camera in the same position for long periods of time.

Even if the camera does not feel too hot, prolonged contact with the same body part may cause skin redness or blistering due to low-temperature contact burns. Using a tripod is recommended when using the camera in very hot places or for people with circulation problems or poor skin sensation.

Scene Icons

In the <A+> shooting mode, the camera detects the scene type and sets everything automatically to suit the scene. The detected scene type is indicated on the upper left of the screen.

Subject Background	Portrait		Non-Portrait			Background Color
		Movement	Nature and Outdoor Scene	Movement	Close*1	
Bright						Gray
Backlit						
Blue Sky Included						Light blue
Backlit						
Sunset	*2			*2		Orange
Spotlight						Dark blue
Dark						
With Tripod	*3*4	*2	*3*4	*2		

*1: Displayed when the attached lens has distance information. With an extension tube or close-up lens, the icon displayed may not match the actual scene.

*2: The icon of the scene selected from the detectable scenes will be displayed.

*3: Displayed when all the following conditions apply:
The shooting scene is dark, it is a night scene, and the camera is mounted on a tripod.

*4: Displayed with any of the lenses below:

- EF-S18-55mm f/3.5-5.6 IS II
- EF-S55-250mm f/4-5.6 IS II
- EF300mm f/2.8L IS II USM
- EF400mm f/2.8L IS II USM
- EF500mm f/4L IS II USM
- EF600mm f/4L IS II USM
- Image Stabilizer lenses released in and after 2012.

*3*4: If the conditions in both *3 and *4 are met, the shutter speed will slow down.



- For certain scenes or shooting conditions, the icon displayed may not match the actual scene.

Shooting Function Settings

Function settings particular to Live View shooting are described here.

Quick Control

Press the **<Q>** button when an image is displayed to access the Quick Control screen, where you can adjust settings.



- 1 Press the **<Q>** button.**
 - The settable functions will be displayed.

2 Select a function and set it.

- Press the **<▲>** **<▼>** keys to select a function.
 - The settings of the selected function and Feature guide (📖55) will appear on the screen.
- Press the **<◀>** **<▶>** keys to set the function.
- In the **<SCN>** and **<C>** modes, select the shooting mode box on the upper left of the screen, then press **<SET>** to select the shooting mode.
- To set Auto white balance, select **[AWB]**, then press the **<☰/☰>** button.
- To set the drive mode's **<C>** setting, WB correction/WB bracketing, Picture Style parameters, or Creative filter effects, press the **<INFO>** button.

3 Exit the setting.

- Press **<SET>** to finalize the setting and return to Live View shooting.
- You can also select **[↶]** to return to Live View shooting.



- In Creative Zone modes, you can set the ISO speed by pressing the **<ISO>** button.
- When you set **[☐]** (Partial metering) or **[□]** (Spot metering), a metering circle will be displayed at the center of the screen.
- With Live View shooting, you cannot set **<□S>** and **<☐S>** in drive mode or self-timer.

Shooting with Creative Filter Effects ☆

While viewing the Live View image, you can apply one of seven filter effects (Grainy B/W, Soft focus, Fish-eye effect, Art bold effect, Water painting effect, Toy camera effect, and Miniature effect) for shooting.

The camera saves only the image with the Creative filter applied. You can also take a picture without a Creative filter, then apply an effect afterward and save it as a new image (📖329).

1 Turn the Mode Dial to a Creative Zone mode.

2 Press the <Q> button.

→ The Quick Control screen will appear.

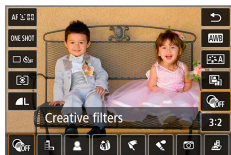

3 Select [OFF].

- Press the <▲> <▼> keys to select [OFF] (Creative filter) on the right side of the screen.



4 Select a filter effect.

- Press the <◀> <▶> keys to select a filter effect (📖190).
- The image will be displayed with the effects of the filter applied.

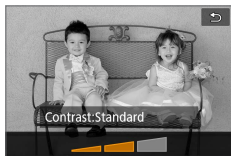

5 Adjust the filter effect.

- Press the <INFO> button (except for 📖).
- Press the <◀> <▶> keys to adjust the effect, then press <SET>.

6 Take the picture.

→ The image is shot with the filter effect applied.









- When you set a Creative filter, single shooting will take effect even if the drive mode is set to .
- Shooting with Creative filters will prevent you from specifying RAW, AEB, white balance bracketing, or Multi Shot Noise Reduction.



- The histogram is not displayed when you shoot with Creative filters.

Creative Filter Characteristics

-  **Grainy B/W**
Creates a grainy black-and-white photo. You can change the black-and-white effect by adjusting the contrast.
-  **Soft focus**
Gives the image a soft look. You can change the degree of softness by adjusting the blur.
-  **Fish-eye effect**
Gives the effect of a fish-eye lens. The image will have a barrel-type distortion.
Depending on the level of this filter effect, the area trimmed along the periphery of the image changes. Also, since this filter expands the center part of the image, the resolution at the center may decrease depending on the number of recorded pixels. Check the image on the screen when setting this filter. The AF point will be fixed to the one at the center.
-  **Art bold effect**
Makes the photo look like an oil painting and the subject look more three-dimensional. You can adjust the contrast and saturation. Note that subjects such as the sky or white walls may not be rendered with a smooth gradation and may look irregular or have significant noise.
-  **Water painting effect**
Makes the photo look like a watercolor painting with soft colors. You can control the color density by adjusting the filter effect. Note that night scenes or dark scenes may not be rendered with a smooth gradation and may look irregular or have significant noise.
-  **Toy camera effect**
Darkens the photo's corners and applies a unique color tone that makes it look as if it was shot by a toy camera. You can change the color cast by adjusting the color tone.

-  **Miniature effect**

Creates a diorama effect.

If you want the image center to look sharp, take the picture without changing any setting.

To move the area where you want to look sharp (miniature effect frame), see “Adjusting Miniature Effect” (📖98). 1-point AF is used as the AF method. Positioning the miniature effect frame over the AF point before shooting is recommended.



- With Grainy B/W, the grainy effect displayed on the LCD monitor will look different from the grainy effect recorded in the picture.
- With the Soft focus and Miniature effect, the blurred effect displayed on the LCD monitor may look different from the blurred effect recorded in the picture. You can check blurring before you shoot by pressing the <SET> or <DISP> button when they are configured as described below.
 - In [**☛**: Custom Functions(C.Fn)], set [**Assign SET button**] to [**7:Depth-of-field preview**].
 - In [**☛**: Custom Functions(C.Fn)], set [**DISP button function**] to [**1:Depth-of-field preview**].

Menu Function Settings

Setting items for Live View shooting are shown on the [CAMERA] and [FUNCTION] tabs in Live View shooting.

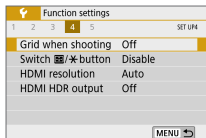
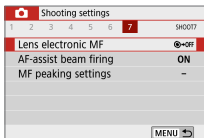
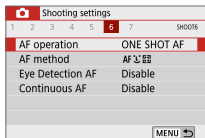
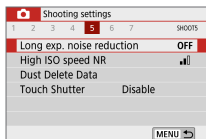
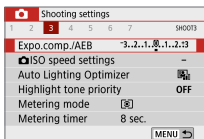
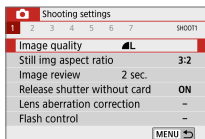

● Still img aspect ratio^{*}

You can change the image's aspect ratio. **[3:2]** is set by default. The area surrounding the Live View image is masked in black when the following aspect ratios are set: **[4:3]** **[16:9]** **[1:1]**.

JPEG images will be saved with the set aspect ratio. RAW images will always be saved with the **[3:2]** aspect ratio. The selected aspect ratio information is added to the RAW image file. When you process the RAW image with Digital Photo Professional (EOS software), this allows you to generate an image with the same aspect ratio that was set for shooting. In the case of the **[4:3]**, **[16:9]**, and **[1:1]** aspect ratios, the lines to indicate the aspect ratio will appear during image playback, but they are not actually drawn on the image.

Image Quality	Aspect Ratio and Pixel Count (Approx.)			
	3:2	4:3	16:9	1:1
L / L	6000×4000 (24 megapixels)	5328×4000* (21.3 megapixels)	6000×3368* (20.2 megapixels)	4000×4000 (16 megapixels)
M / M	3984×2656 (10.6 megapixels)	3552×2664 (9.5 megapixels)	3984×2240* (8.9 megapixels)	2656×2656 (7.1 megapixels)
S1 / S1	2976×1984 (5.9 megapixels)	2656×1992 (5.3 megapixels)	2976×1680* (5 megapixels)	1984×1984 (3.9 megapixels)
S2	2400×1600 (3.8 megapixels)	2112×1600* (3.4 megapixels)	2400×1344* (3.2 megapixels)	1600×1600 (2.6 megapixels)
RAW / RAW	6000×4000 (24 megapixels)	6000×4000 (24 megapixels)	6000×4000 (24 megapixels)	6000×4000 (24 megapixels)



- **[4:3], [16:9], and [1:1]** are available in Live View shooting.
- Pixel counts are rounded to the nearest ten thousand or thousand.
- JPEG images are created at your specified aspect ratio.
- RAW images are captured at 3:2 and tagged to indicate your specified aspect ratio.
- The image-recording quality and aspect ratio with an asterisk do not exactly match the indicated ratio.

- **Metering timer**★

You can change how long the exposure setting is displayed (AE lock time). In Basic Zone modes, metering timer is fixed at 8 sec.

- **Touch Shutter** (📖208)

Just by tapping on the LCD monitor screen, you can focus and take the picture automatically.

- **AF method** (📖197)

You can select [**☑️+Tracking**], [**Spot AF**], [**1-point AF**], or [**Zone AF**]. Note that in **<A+>** mode, the AF method is set to [**☑️+Tracking**] and cannot be changed.

- **Eye detection AF** (📖204)

With the AF method set to [**☑️+Tracking**], you can shoot with the subject's eyes in focus.

- **Continuous AF** (📖205)

Helps avoid missing sudden photo opportunities, because the camera constantly focuses on subjects until you press the shutter button halfway.

- **MF peaking settings**★ (📖213)

Edges of subjects in focus can be displayed in color to make focusing easier.

- **Grid when shooting**

With **[3x3 田]** or **[6x4 田田]**, you can display grid lines to help you level the camera vertically or horizontally. Also, with **[3x3+diag 田田田]**, the grid is displayed together with diagonal lines to help you compose with better balance by aligning the intersections over the subject.



- Selecting **[CAM: Dust Delete Data]** or either **[Clean manually]** or **[Clean now 掃除]** under **[CAM: Sensor cleaning]** will stop the Live View shooting. To start Live View shooting again, press the **<CAM>** button.

Changing the Autofocus Operation ☆

You can select the AF (autofocus) operation characteristics to suit the shooting conditions or subject. In Basic Zone modes, the optimum AF operation is set automatically for the respective shooting mode.



1 Press the <Q> button.

→ The Quick Control screen will appear.

2 Select [ONE SHOT].

- Press the <▲> <▼> keys to select [ONE SHOT] (AF operation) on the left side of the screen.

3 Select the AF operation.

- Press the <◀> <▶> keys to select the desired AF operation, then press <SET>.

ONE SHOT : One-Shot AF

SERVO : Servo AF

4 Focus on the subject.

- Aim the AF point over the subject and press the shutter button halfway. The camera will then autofocus in the selected AF operation.



- Settable only for Live View shooting (not settable for movie shooting).
- If focus cannot be achieved, the AF point will turn orange. If this occurs, the picture cannot be taken even if the shutter button is pressed completely. Recompose the shot and try to focus again. Or, see “Shooting Conditions that Make Focusing Difficult” (1202).

One-Shot AF for Still Subjects

Suited for still subjects. When you press the shutter button halfway, the camera will focus only once.

- When focus is achieved, the AF point will turn green and the beeper will sound.
- The focus remains locked while you hold down the shutter button halfway, allowing you to recompose the image before taking the picture.
- For flash photography, the continuous shooting speed will become slower.



- If [**Beep**] is set to [**Disable**], the beeper will not sound when focus is achieved.

Servo AF for Moving Subjects

This AF operation is suited for moving subjects. While you hold down the shutter button halfway, the camera will keep focusing on the subject continuously.

- Subject tracking is given priority when the drive mode is set to <[**C**]> for continuous shooting.
- For flash photography, the continuous shooting speed will become slower.
- When focus is achieved, the AF point will turn blue.
- The exposure is set at the moment the picture is taken.
- When [**AF method**] is set to [**Tracking**], focusing will be continuous as long as the Area AF frame can track the subject.



- Depending on the lens used, the distance to the subject and the subject's speed, the camera may not be able to achieve correct focus.
- Zooming during continuous shooting may throw off the focus. Zoom first, then recompose and shoot.



- With Servo AF, the beeper will not sound even when focus is achieved.

Focusing with AF

Selecting the AF Method

You can select an AF method to suit the shooting conditions and your subject. As the AF method, you can select [**AF**] (**face**)+Tracking (📖198), [**Spot AF**], [**1-point AF**], or [**Zone AF**] (📖200).

If you want to achieve precise focus, set the lens's focus mode switch to <MF>, magnify the image, and focus manually (📖212).

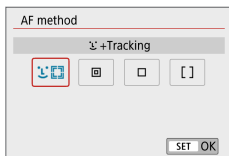

Select the AF method.

- Under the [**Q**] tab, select [**AF method**].
- Select the desired AF method, then press <SET>.
- While the Live View image is displayed, you can also press the <Q> button to select the AF method on the Quick Control screen (📖187).



- The descriptions on 📖198–📖200 assume that [**AF operation**] is set to [**One-shot AF**] (📖196). With [**Servo AF**] (📖196) set, the AF point will turn blue when focus is achieved.
- In the <SCN: 多 > modes, Servo AF is set automatically, and when focus is achieved, the AF point will turn blue and the beeper will sound.
- Only [**AF**] and [**1-point AF**] are available when 4K movie recording is set.
- Regarding the Touch Shutter (AF and shutter release by touch operation), see page 208.

Face+Tracking

The camera detects and focuses on human faces. If a face moves, the AF point <[]> also moves to track the face.



1 Check the AF point.

- When a face is detected, <[]> will appear over the face to be focused on.
- If multiple faces are detected, <[]> will be displayed. Use <◀> <▶> to move <[]> over the face you want to focus on.
- You can also tap on the LCD monitor screen to select the face or subject.

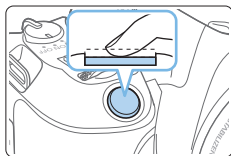

2 Focus on the subject.

- Press the shutter button halfway to focus.
- ➔ If no faces can be detected or if you do not tap anything on the screen, focus will be achieved within the Area AF frame.
- ➔ When focus is achieved, the AF point will turn green and the beeper will sound.
- ➔ If focus is not achieved, the AF point will turn orange.

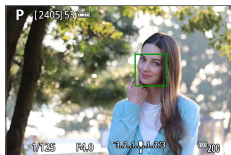

3 Take the picture.

- Check the focus and exposure, then press the shutter button completely to take the picture (📖 181).

- **Focusing on a subject other than a human face**

Once the AF point <[]> achieves focus, the AF point <[]> will also move to track the subject if you change the composition or if the subject moves.



- If the subject's face is significantly out of focus, face detection will not be possible. Adjust the focus manually (📖212) so that the face can be detected, then perform AF.
- An object other than a human face may be detected as a face.
- Face detection will not work if the face is very small or large in the picture, too bright or too dark, or partially hidden.
- The <[]> may cover only a part of the face, not the whole face.



- The size of the AF point changes depending on the subject.

Spot AF/1-Point AF/Zone AF

You can manually set the AF point or Zone AF frame. Here, 1-point AF screens are used as an example.



(1)

1 Check the AF point.

- The AF point (1) will appear.
- With Zone AF, the Zone AF frame is displayed.



2 Move the AF point.

- You can also move the AF point by touching the screen or pressing the <⬆> cross keys.
- To center the AF point or Zone AF frame, press the <⏏> button.
- To magnify display, press the <🔍> button. Each press of the <🔍> button changes the magnification ratio.

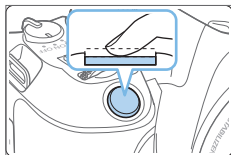

3 Focus on the subject.

- Aim the AF point over the subject and press the shutter button halfway.
- ➔ When focus is achieved, the AF point will turn green and the beeper will sound.
- ➔ If focus is not achieved, the AF point will turn orange.



4 Take the picture.

- Press the shutter button completely to take the picture (📖181).



- Focusing may be difficult when using a peripheral AF point. In this case, select an AF point in the center.

Notes for AF

AF Operation

- Even when focus is achieved, pressing the shutter button halfway will focus again.
- The image brightness may change during and after the AF operation.
- Depending on the subject and shooting conditions, it may take longer to focus, or the continuous shooting speed may decrease.
- If the light source changes while the Live View image is displayed, the screen may flicker and focusing may be difficult. If this happens, exit Live View shooting and perform AF under the actual light source under which you are shooting.



- If you cannot achieve focus with AF, set the lens's focus mode switch to <MF> and focus manually (📖212).
- If you shoot the subject at the periphery and it is slightly out of focus, recompose to move the subject (and AF point) toward the screen center, focus again, then take the picture.
- The AF-assist beam will not be emitted. However, if an EX-series Speedlite equipped with an LED light is used, the LED light will turn on for AF-assist as necessary.
- With certain lenses, it may take more time to achieve focus with autofocus, or accurate focusing may not be achieved.

Shooting Conditions that Make Focusing Difficult

- Subject with low-contrast such as the blue sky, solid-color flat surfaces or when highlight or shadow details are clipped.
- Subjects in low light.
- Stripes and other patterns where there is contrast only in the horizontal direction.
- Subjects with repetitive patterns (Example: Skyscraper windows, computer keyboards, etc.).
- Fine lines and subject outlines.
- Under a light source whose brightness, color, or pattern keeps changing.
- Night scenes or points of light.
- The image flickers under fluorescent or LED lighting.
- Extremely small subjects.
- Subjects at the edge of the screen.
- Strongly backlit or reflective subjects (Example: Car with a highly reflective body, etc.).
- Near and distant subjects covered by an AF point (Example: Animal in a cage, etc.).
- Subjects that keep moving within the AF point and will not stay still due to camera shake or subject blur.
- Performing AF when the subject is very far out of focus.
- Soft focus effect is applied with a soft focus lens.
- A special effect filter is used.
- Noise (dots of light, banding, etc.) appears on the screen during AF.

AF Range

The available autofocus range varies depending on the lens and aspect ratio used and whether you are recording 4K movies or using features such as Movie digital IS.

Magnified View



To check the focus when the AF method is other than [**L**+Tracking], magnify display by approx. 5× or 10× by pressing the <Q> button or tapping [**Q**] in the lower right. Magnified view is not available with [**L**+Tracking].

- To move the AF point, press the <⬆> cross keys or tap on the spot you want to magnify.
- Either press the <Q> button or tap on [**Q**] to magnify the area covered by the magnifying frame. Each time you press the <Q> button or tap on [**Q**], the magnification ratio changes.
- Magnification is centered on the AF point for [**Spot AF**], and [**1-point AF**] and is centered on the Zone AF frame for [**Zone AF**].
- Autofocusing is performed with magnified display if you press the shutter button halfway when set to [**1-point AF**], or [**Spot AF**]. When set to other AF methods, autofocusing is performed after restoring normal display.
- With Servo AF, if you press the shutter button halfway in the magnified view, the camera will return to the normal view for focusing.



- If focusing is difficult in the magnified view, return to the normal view and perform AF.
- If you perform AF in the normal view and then use the magnified view, accurate focus may not be achieved.
- AF speed differs between normal view and magnified view.
- When in magnified view, Movie Servo AF (📖253) will not function.
- With the magnified view, achieving focus becomes more difficult due to camera shake. Using a tripod is recommended.

Focusing on People's Eyes

With the AF method set to [L+Tracking], you can shoot with the subject's eyes in focus.

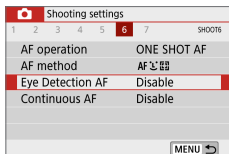

1 Select [Eye Detection AF].

- Under the [CAM] tab, select [Eye Detection AF], then press <SET>.

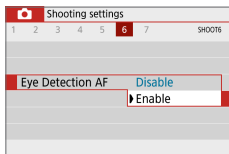

2 Select [Enable].

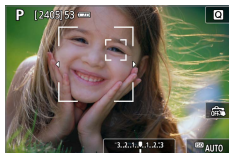

3 Aim the camera at the subject.

- An AF point is displayed around their eye.
- You can tap the screen to select an eye for focus.
The entire face is selected when you tap other facial features, such as their nose or mouth. Eyes to focus on are selected automatically.
- You can select an eye or face with the <◀> <▶> keys when <[L+Tracking]> or <[L]> appears.

4 Take the picture.

- Subject eyes may not be detected correctly, depending on the subject and shooting conditions.

Setting Continuous AF

This function keeps subjects generally in focus. The camera is ready to focus immediately when you press the shutter button halfway.

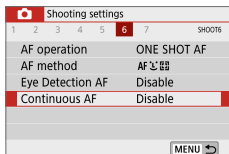

1 Select [Continuous AF].

- Under the [] tab, select [Continuous AF], then press <SET>.

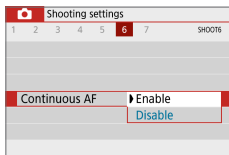

2 Select [Enable].



- Enabling this function reduces the number of shots available, because the lens is driven continuously and battery power is consumed.

Using the Self-timer

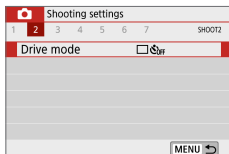

1 Select [Drive mode].

- Under the [📷] tab, select [Drive mode], then press <SET>.

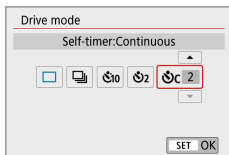

2 Select the self-timer.

- Press the <◀> <▶> keys to select the self-timer, then press <SET>.

📷/📷: 10 sec./remote control self-timer

The picture is taken 10 seconds after you press the shutter button. Remote control shooting with the Wireless Remote Control BR-E1 (sold separately) is also possible (📖463).

📷₂: 2-sec. self-timer

The picture is taken 2 seconds after you press the shutter button.

📷_C: 10-sec. self-timer plus continuous shots

10 seconds after you press the shutter button, the set number of multiple shots are taken. Press the <▲> <▼> keys to set the number of multiple shots (2 to 10) to be taken with the self-timer.

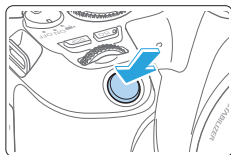

3 Take the picture.

- Focus on the subject, then press the shutter button completely.
- ➔ To check operation, listen for beeps or watch the countdown display (in seconds) on the LCD monitor.
- ➔ 2 sec. before the picture is taken, the beeper will sound faster.



- With <S/C>, the interval between the multiple shots may be prolonged depending on the shooting functions settings such as the image-recording quality or flash.
- If stray light enters the viewfinder when the picture is taken, it may throw off the exposure. Live View shooting is recommended.



- After taking self-timer shots, playing back the image (📖101) to check focus and exposure is recommended.
- When using the self-timer to shoot yourself, use focus lock (📖74) on an object at the same distance as where you will stand.
- To cancel the self-timer after it starts, either tap on the LCD monitor or press <SET>.

Shooting with the Touch Shutter

Just by tapping on the LCD monitor screen, you can focus and take the picture automatically.



1 Enable the Touch Shutter.

- Tap [OFF].
Each time you tap on the icon, it will toggle between [OFF] and [ON].
- [ON] (Touch Shutter: Enable)
The camera will focus on the spot you tap on, then the picture will be taken.
- [OFF] (Touch Shutter: Disable)
You can tap on a spot to perform focusing on the spot (Touch AF). Press the shutter button completely to take the picture.

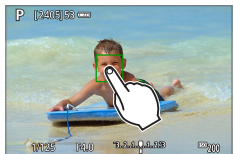

2 Tap on the screen to shoot.

- Tap on the face or subject on the screen.
- ➔ On the point you tap, the camera will focus (Touch AF) with the AF method that was set (197).
- ➔ When focus is achieved, the AF point turns green and the picture is taken automatically.
- If focus is not achieved, the AF point turns orange and the picture cannot be taken. Tap on the face or subject on the screen again.



- Even if you set the drive mode to <[S]>, the camera will still shoot in the single shooting mode.
- Even if [AF operation] is set to [Servo AF], tapping on the screen will focus on the image with [One-Shot AF].
- Tapping on the screen in magnified view will not focus or take the picture.
- If the Fish-eye effect Creative filter is set, the camera will focus using the AF point at the center of the screen regardless of the point you tap on.
- If the Miniature effect Creative filter is set, the Touch Shutter does not work.



- You can also set the Touch Shutter with [: **Touch Shutter**].
- To shoot with bulb exposure, tap on the screen twice. The first tap on the screen will start the bulb exposure. Tapping it again will stop the exposure. Be careful not to shake the camera when tapping on the screen.

Taking a Self Portrait (Selfie)

The Self Portrait mode processes the image to suit human subjects. Before shooting, you can also specify background blurring, brightness, and skin smoothing.

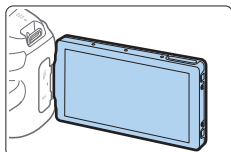

1 Face the LCD monitor toward the front of the camera.

- As shown in the illustration, flip out the LCD monitor and face it toward the front of the camera (📖40).



2 Tap [📷] on the screen.

- Tap [📷] on the screen to activate Self Portrait mode.

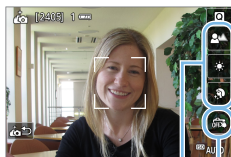

3 Set the Self Portrait settings.

- Tap a function (1) to select it, then set the effect.

4 Take the picture.

When using the Touch Shutter:

- Tap [OFF] (2) and set to [📷] (Touch Shutter: Enable) (📖208).
- Tap on the spot where you want to focus, then take the picture.

When using the shutter button:

- Press the shutter button halfway to focus, then press it completely to take the picture.

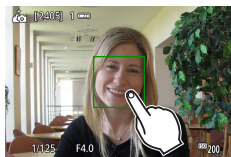



(1) (2)



- After the camera achieves focus, do not change the distance between you and the camera until the picture is taken.
- Be careful not to drop the camera.
- Flash photography is not possible. Try to prevent camera shake when shooting in low-light conditions.



- The Self Portrait mode will be canceled when you set the camera switch to <OFF> or do any of the following:
 - Tapping [] on the screen.
 - Rotating the LCD monitor back to its original position.
 - Pressing the < > button.

MF: Focusing Manually

You can magnify the image and focus precisely with MF (manual focus).

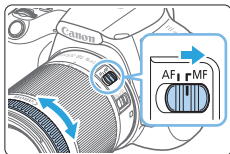

1 Set the lens's focus mode switch to <MF>.

- Turn the lens focusing ring to focus roughly.

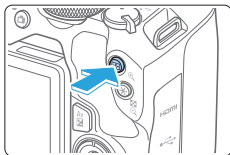

2 Display the magnifying frame.

- Press the <Q> button.
- ➔ The magnifying frame will appear.
- You can also tap [Q] on the screen to magnify the image.



3 Move the magnifying frame.

- Press the <⬆️> cross keys to move the magnifying frame to where you want to focus.
- Pressing the <⏏️> button will return the magnifying frame to the screen center.



(1)(2)(3)

4 Magnify the image.

- Each time you press the <Q> button, the magnification of the image will change in the following sequence:

→ Normal display → 5x → 10x →

- (1) AE lock
- (2) Magnified area position
- (3) Magnification

5 Focus manually.

- While looking at the magnified image, turn the lens focusing ring to focus.
- After achieving focus, press the <Q> button to return to the normal view.

6 Take the picture.

- Check the focus and exposure, then press the shutter button to take the picture (📖 181).



- In magnified view, the exposure is locked. (Shutter speed and aperture will be displayed in red.)
- Even with manual focusing, you can use the Touch Shutter to take a picture.

Setting MF Peaking (Outline Emphasis)

Edges of subjects in focus can be displayed in color to make focusing easier. You can set the outline color and adjust the sensitivity (level) of edge detection (except in <A+> mode).

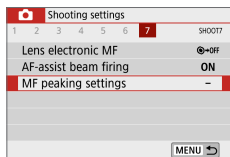

1 Select [MF peaking settings].

- Under the [📷] tab, select [MF peaking settings], then press <SET>.

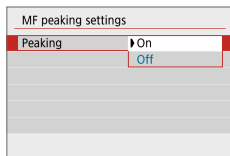

2 Select [Peaking].

- Select [Peaking], then press <SET>.
- Select [On], then press <SET>.



General Live View Shooting Cautions

Image Quality

- When you shoot at high ISO speeds, noise (such as dots of light and banding) may become noticeable.
- Shooting in high temperatures may cause noise and irregular colors in the image.
- If Live View shooting is used continuously for a prolonged period, the camera's internal temperature may rise, and image quality may deteriorate. Always exit Live View shooting when you are not shooting.
- If you shoot a long exposure while the camera's internal temperature is high, image quality may deteriorate. Exit Live View shooting and wait a few minutes before shooting again.

White <[Icon]> and Red <[Icon]> Internal Temperature Warning Icons

- If the camera's internal temperature increases due to prolonged Live View shooting or under a high ambient temperature, a white <[Icon]> or red <[Icon]> icon will appear.
- The white <[Icon]> icon indicates that the image quality of still photos will deteriorate. It is recommended that you temporarily exit Live View shooting and allow the camera to cool down before shooting again.
- The red <[Icon]> icon indicates that the Live View shooting will soon stop automatically. If this happens, you will not be able to shoot again until the camera's internal temperature decreases. Temporarily exit the Live View shooting or turn off the power and let the camera rest for a while.
- Using Live View shooting at a high temperature for a prolonged period will cause the <[Icon]> or <[Icon]> icon to appear earlier. When you are not shooting, always turn off the camera.
- If the camera's internal temperature is high, the quality of images shot with a high ISO speed or long exposure may deteriorate even before the white <[Icon]> icon is displayed.

Shooting Results

- If you take the picture in magnified view, the exposure may not come out as desired. Return to the normal view before taking the picture. In magnified view, the shutter speed and aperture will be displayed in red. Even if you take the picture in magnified view, the image will be captured with the image area of the normal view.
- If you use a TS-E lens (except the TS-E17mm f/4L or TS-E24mm f/3.5L II) for shifting or tilting the lens or if you use an extension tube, the standard exposure may not be obtained, or an irregular exposure may result.



General Live View Shooting Cautions

Live View Image

- Under low- or bright-light conditions, the Live View image may not reflect the brightness of the captured image.
- Even if a low ISO speed is set, noise may be noticeable in the displayed Live View image under low light. However, when you shoot, the image recorded will have less noise. (The image quality of the Live View image is different from that of the recorded image.)
- If the light source (illumination) within the image changes, the screen may flicker. If this happens, exit Live View shooting and resume Live View shooting under the actual light source.
- If you point the camera in a different direction, it may throw off the Live View image's correct brightness momentarily. Wait until the brightness level stabilizes before shooting.
- If there is a very bright light source in the image, the bright area may appear black on the LCD monitor. However, the actual captured image will correctly show the bright area.
- In low light, if you set the [**F**: **Disp. brightness**] to a bright setting, noise or irregular colors may appear in the Live View image. However, the noise or irregular colors will not be recorded in the captured image.
- When you magnify the image, the image sharpness may look more pronounced than in the actual image.
- If the shutter speed is 1 sec. or slower, "**BUSY**" is displayed on the LCD monitor, and the Live View display will not appear until the exposure is complete.

Custom Functions

- During Live View shooting, certain Custom Function settings will not take effect.

Lens and Flash

- If the attached lens has an Image Stabilizer and you set the Image Stabilizer (IS) switch to <ON>, the Image Stabilizer will operate at all times even if you do not press the shutter button halfway. The Image Stabilizer consumes battery power and may decrease the number of possible shots depending on the shooting conditions. When the Image Stabilizer is not necessary, such as when using a tripod, it is recommended that you set the IS switch to <OFF>.
- The focus preset function is possible for Live View shooting only when using a (super) telephoto lens equipped with the focus preset mode released in and after the second half of 2011.
- FE lock will not work if the built-in flash is used. FE lock and modeling flash will not work if an external Speedlite is used.

Shooting Movies



Movie shooting is enabled by setting the power switch to <MOVIE>.

- For cards that can record movies, see page 7.
- If you handhold the camera and shoot movies, camera shake can cause blurred movies. In such a case, using a tripod is recommended.
- To shoot while handholding the camera, see page 75.

Shooting Movies

Connecting the camera to a TV set is recommended to play back the shot movies (📖305).

Autoexposure Shooting

When the shooting mode is set to any mode other than <M>, autoexposure control will take effect to suit the scene's current brightness.

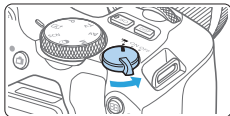

1 Set the power switch to <📷>.

- ➔ The reflex mirror will make a sound, then the image will appear on the LCD monitor.

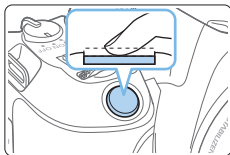

2 Set the Mode Dial to a mode other than <SCN>, <📷>, or <M>.

3 Focus on the subject.

- Before shooting a movie, focus with AF or manual focus (📖197–📖203, 📖212).
- By default, [Movie Servo AF: Enable] is set so that the camera always keeps focusing. To stop Movie Servo AF, see 📖253.

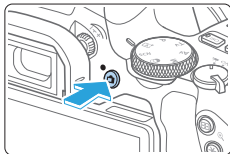

4 Shoot the movie.

- Press the <📷> button to start shooting a movie. To stop movie shooting, press the <📷> button again.
- ➔ While the movie is being shot, the “●REC” mark will be displayed on the upper right of the screen.
- ➔ Sound will be recorded by the built-in microphones (1).



(1)



- **General Movie Shooting Cautions** are on 257– 258.
- If necessary, also read “**General Live View Shooting Cautions**” on 215– 216.



- In the **<Av>** and **<Tv>** shooting modes, the settings will be the same as when shooting in the **<P>** mode.
- Settable menu functions differ between Basic Zone modes and Creative Zone modes.
- Shutter speed, aperture and ISO speed are set automatically.
- In Creative Zone modes, you can press the **<★>** button (164) to lock the exposure (AE lock). The exposure setting will be displayed for the number of seconds set with **[☷: Metering timer]**. After applying AE lock during movie shooting, you can cancel it by pressing the **<☷>** button. (AE lock setting is retained until you press the **<☷>** button.)
- In Creative Zone modes, you can turn the dial while holding down the **<Av☷>** button to set the exposure compensation.
- If you shoot a movie with autoexposure, the shutter speed, aperture and ISO speed will not be recorded in the movie's Exif information.
- With autoexposure movie shooting (except in time-lapse movie shooting), the camera will automatically turn on the Speedlite's LED light under low-light conditions. For details, refer to the Instruction Manual of the EX-series Speedlite equipped with an LED light.

ISO Speed in Basic Zone Modes

- The ISO speed will be set automatically within ISO 100–ISO 12800. Note that when the camera is set for 4K movies, ISO speed is ISO 100–ISO 6400.

ISO Speed in the **<P>**, **<Tv>**, and **<Av>** Modes

- The ISO speed will be set automatically within ISO 100–ISO 12800. The maximum limit varies depending on the **[Max for Auto]** setting in **[☷: ISO Auto]** setting (254). Note that when the camera is set for 4K movies, ISO speed is ISO 100–ISO 6400.
- Under **[☷: Custom Functions(C.Fn)]**, if **[ISO expansion]** is set to **[1:On]**, **[H(25600)]** can also be selected for **[Max for Auto]**. Note that when the camera is set for 4K movies, ISO speed is ISO 100–ISO 6400.
- When **[☷: Highlight tone priority]** is set to **[Enable]**, the ISO speed range is ISO 200–ISO 12800. Note that when the camera is set for 4K movies, ISO speed is ISO 100–ISO 6400.



- When switching from still photo shooting to movie shooting, check the ISO speed settings again before shooting movies.

Scene Icons

During movie shooting in <A+>, an icon representing the scene detected by the camera will be displayed, and the shooting will be performed to suit the scene. For certain scenes or shooting conditions, the icon displayed may not match the actual scene.

Background \ Subject	Portrait	Non-Portrait		Background Color
		Nature and Outdoor Scene	Close*1	
Bright				Gray
	Backlit			
Blue Sky Included				Light blue
	Backlit			
Sunset	*2		*2	Orange
Spotlight				Dark blue
Dark				

*1 : Displayed when the attached lens has distance information. With an extension tube or close-up lens, the icon displayed may not match the actual scene.

*2 : The icon of the scene selected from the detectable scenes will be displayed.

Manual Exposure Shooting

In the <M> mode, you can manually set the shutter speed, aperture, and ISO speed for movie shooting. Using manual exposure to shoot movies is for advanced users.

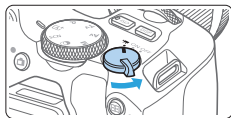

1 Set the power switch to <Movie>.

- ➔ The reflex mirror will make a sound, then the image will appear on the LCD monitor.

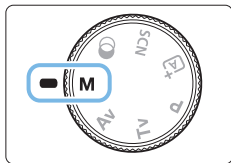

2 Set the Mode Dial to <M>.



3 Set the ISO speed.

- Press the <ISO> button and press the <◀> <▶> keys or turn the <ISO> dial to select the ISO speed.
- For details on the ISO speed, see page 222.

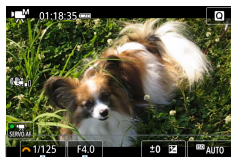

4 Set the shutter speed and aperture.

- To set the shutter speed (1), turn the <ISO> dial.
- To set the aperture (2), turn the <ISO> dial while holding down the <Av/☒> button.

(1) (2)

5 Focus and shoot the movie.

- The procedure is the same as steps 3 and 4 for “Shooting Movies” (📖218).

ISO Speed During Manual Exposure Shooting

- With **[AUTO]**, the ISO speed will be set automatically within ISO 100–ISO 12800. The maximum limit varies depending on the **[Max for Auto]** setting in **[📷:⚙️ ISO Auto]** setting (📖254). Note that when the camera is set for 4K movies, ISO speed is ISO 100–ISO 6400.
- You can set the ISO speed manually within ISO 100–ISO 12800 in whole-stop increments. Under **[🔧: Custom Functions(C.Fn)]**, if you set **[ISO expansion]** to **[1:On]**, the maximum limit of the manual ISO speed setting range will be expanded so you can also select H (equivalent to ISO 25600). Note that when the camera is set for 4K movies, ISO speed is ISO 100–ISO 6400.
- If **[📷: Highlight tone priority]** is set to **[Enable]**, the ISO speed will be ISO 200–ISO 12800. Note that when the camera is set for 4K movies, ISO speed is ISO 100–ISO 6400.



- Since shooting a movie at ISO 25600 equivalent may result in much noise, it is designated as an expanded ISO speed (displayed as “H”).
- When switching from still photo shooting to movie shooting, check the camera settings again before shooting movies.
- Changing the shutter speed or aperture during movie shooting is not recommended since the changes in the exposure will be recorded.
- When shooting a movie of a moving subject, a shutter speed of approx. 1/30 sec. to 1/125 sec. is recommended. The faster the shutter speed, the less smooth the subject’s movement will look.
- If you change the shutter speed while shooting under fluorescent or LED lighting, image flicker may be recorded.



- If you set **[5:Expo comp (hold btn, turn 🌞)]** with **[Assign SET button]** under **[🔧: Custom Functions(C.Fn)]** (📖452), you can use exposure compensation with ISO Auto set.
- When ISO Auto is set, you can press the **<✳>** button to lock the ISO speed.
- If you press the **<✳>** button and recompose the shot, you can see the exposure level difference on the exposure level indicator (📖223) compared to when the **<✳>** button was pressed.
- By pressing the **<INFO>** button, you can display the histogram.

Information Display

- Each time you press the <INFO> button, the information display will change.

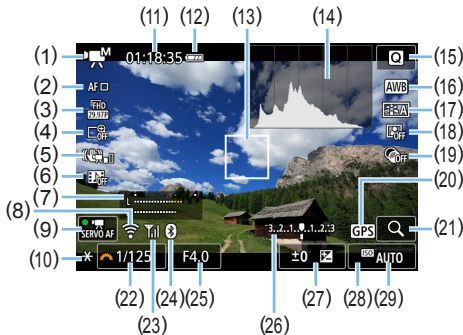

- | | |
|---|--|
| <p>(1) Movie shooting mode/Scene icon</p> <ul style="list-style-type: none"> ☀️^A : Autoexposure (Basic Zone modes) ☀️ : Autoexposure (Creative Zone modes) ☀️^M : Manual exposure HDR : HDR movie 🎨 : Creative filters 🕒 : Time-lapse movie <p>(2) AF method</p> <ul style="list-style-type: none"> • AF : + Tracking • AF : Spot AF • AF : 1-point AF • AF : Zone AF <p>(3) Movie recording size</p> <p>(4) Digital zoom</p> <p>(5) Movie digital IS</p> <p>(6) Video snapshot</p> <p>(7) Recording level (manual)</p> <p>(8) Wi-Fi function</p> <p>(9) Movie Servo AF</p> <p>(10) AE lock</p> | <p>(11) Movie shooting remaining time*/ Elapsed time</p> <p>* Applies to a single movie clip.</p> <p>(12) Battery level</p> <p>(13) AF point</p> <p>(14) Histogram (for manual exposure)</p> <p>(15) Quick Control</p> <p>(16) White balance</p> <p>(17) Picture Style</p> <p>(18) Auto Lighting Optimizer</p> <p>(19) Creative filters</p> <p>(20) GPS connection indicator</p> <p>(21) Magnify/Digital zoom</p> <p>(22) Shutter speed</p> <p>(23) Wi-Fi signal strength</p> <p>(24) Bluetooth function</p> <p>(25) Aperture</p> <p>(26) Exposure level indicator (for manual exposure)</p> <p>(27) Exposure level indicator</p> <p>(28) ISO</p> <p>(29) AUTO</p> |
|---|--|

(27) Exposure compensation

(29) ISO speed

(28) Highlight tone priority



- The grid lines, or histogram cannot be displayed during movie shooting. (The display will disappear when you start shooting a movie.)
- When movie shooting starts, the movie shooting remaining time will change to the elapsed time.

Still Photo Shooting

Still photos cannot be taken during movie shooting.

To take still photos, stop the movie shooting and take still photos using viewfinder shooting or Live View shooting.



Cautions for Movie Shooting

- Do not point the camera toward an intense light source, such as the sun or an intense artificial light source. Doing so may damage the image sensor or the camera's internal components.
- When you press the shutter button halfway to autofocus during movie shooting, the following phenomena may occur.
 - Focus may become far off momentarily.
 - The brightness of the recorded movie may change.
 - The recorded movie may be momentarily still.
 - The movie may record the lens mechanical sound.
- If <AWB> or <AWB w> is set and the ISO speed or aperture changes during movie shooting, the white balance may also change.
- If you shoot a movie under fluorescent or LED lighting, the movie image may flicker.
- Shooting a few test movies is recommended if you intend to perform zooming during movie shooting. Zooming during movie shooting may result in recording of changes in exposure or mechanical sound of the lens, or images may be out of focus.
- During movie shooting, you cannot magnify the image even if you press the <Q> button.
- Be careful not to cover the built-in microphones (📖218) with your fingers, etc.
- If you connect or disconnect the HDMI cable during movie shooting, the movie shooting will end.
- **General Movie Shooting Cautions are on 📖257–📖258.**
- **If necessary, also read “General Live View Shooting Cautions” on 📖215–📖216.**



Warnings:

Do not hold the camera in the same position for long periods of time.

Even if the camera does not feel too hot, prolonged contact with the same body part may cause skin redness or blistering due to low-temperature contact burns. Using a tripod is recommended when using the camera in very hot places or for people with circulation problems or poor skin sensation.



Notes for Movie Shooting

- Each time you shoot a movie, a new movie file is created on the card.
- The movie's field of view coverage for recording 4K, Full HD, and HD movies is approx. 100%.
- Stereo sound is recorded by the camera's built-in microphones.
- If you connect the Directional Stereo Microphone DM-E1 (sold separately) to the camera's external microphone IN terminal (📖28), the external microphone is given the priority.
- Most external microphones equipped with a 3.5 mm diameter mini plug can be used.
- The focus preset function is possible for movie shooting when using a (super) telephoto lens equipped with the focus preset mode, released in and after the second half of 2011.

Shooting Function Settings

Function settings particular to movie shooting are described here.

Quick Control

If you press the <Q> button when the image is displayed on the LCD monitor, you can set AF method, Movie rec. size, Digital zoom, Movie digital IS, Video snapshot, White balance, Picture Style, Auto Lighting Optimizer, and Creative filters.

Note that in Basic Zone modes, available items vary by shooting mode.



1 Press the <Q> button.

→ The settable functions will be displayed.

2 Select a function and set it.

- Press the <▲> <▼> keys to select a function.
- The settings of the selected function and Feature guide (📖55) will appear on the screen.
- Press the <◀> <▶> keys to set the function.
- To set Auto white balance, select [AWB], then press the <☑/Q> button.
- To set the WB correction, Picture Style parameters, or Creative filters, press the <INFO> button.
- Pressing <SET> will return the camera to movie shooting.
- You can also select [↶] to return to movie shooting.

Setting the Movie Recording Size

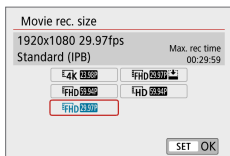

With [**📷: Movie rec. size**], you can set the movie recording size (image size, frame rate, and compression method) and other functions.

Movies will be recorded in the MP4 format.

● Image size

4K 3840x2160

The movie is recorded in 4K quality. The aspect ratio is 16:9.

FHD 1920x1080

Full High-Definition (Full HD) recording quality. The aspect ratio is 16:9.

HD 1280x720

High-Definition (HD) recording quality. The aspect ratio is 16:9.



- Normal playback of 4K and **FHD 59.94P / 50.00P** movies may not be possible on other devices, because playback is processing-intensive.



- The frame rate displayed on the movie recording size screen switches depending on whether [**📷: Video system**] is set to [**For NTSC**] or [**For PAL**].
- If you change the [**📷: Video system**] setting, set the movie recording size again.
- Movies cannot be recorded in VGA quality.

● 4K movie shooting

- Recording 4K movies requires a high-performance card.
- Recording 4K movies greatly increases the processing load, which may cause the camera's internal temperature to increase faster or become higher than for regular movies.
- From a 4K movie, you can select any frame to save as an approx. 8.3-megapixel (3840×2160) JPEG still image to the card (📖 301).



- Contrast detection is used to focus when recording 4K movies. Focusing may take longer and be more difficult than when recording HD or Full HD movies.

- **Frame rate** (fps: frame per second)

29.97P 29.97fps/ **59.94P** 59.94fps

For areas where the TV system is NTSC (North America, Japan, South Korea, Mexico, etc.).

25.00P 25.00fps/ **50.00P** 50.00fps

For areas where the TV system is PAL (Europe, Russia, China, Australia, etc.).

23.98P 23.98fps

Mainly for motion pictures.

- **Compression method**

IPB IPB (Standard)

Compresses multiple frames at a time efficiently for recording.

IPB  IPB (Light)

Since the movie is recorded at a low bit rate for playback on various devices, the file size will be smaller than with IPB (Standard).

Therefore, you can shoot longer than with IPB (Standard).

- **Movie recording format**

MP4 MP4

All movies you shoot with the camera are recorded as movie files in MP4 format (file extension “.MP4”).

Movie Files Exceeding 4 GB

Even if you shoot a movie exceeding 4 GB, you can keep shooting without interruption.

- **Using SD/SDHC cards formatted with the camera**

If you use the camera to format an SD/SDHC card, the camera will format it in FAT32.

With a FAT32-formatted card, if you shoot a movie and the file size exceeds 4 GB, a new movie file will be created automatically.

When you play back the movie, you will have to play each movie file individually. Movie files cannot be played back automatically in consecutive order. After the movie playback ends, select the next movie and play it back.

- **Using SDXC cards formatted with the camera**



If you use the camera to format an SDXC card, the camera will format it in exFAT.

When using an exFAT-formatted card, even if the file size exceeds 4 GB during movie shooting, the movie will be saved as a single file (rather than being split into multiple files).

Movie Shooting Time Limit

The maximum recording time per movie is 29 min. 59 sec. Once 29 min. 59 sec. is reached, recording automatically stops. You can start shooting a movie again by pressing the <  > button. (The movie will be recorded as a new movie file.)



- When downloading movie files exceeding 4 GB to a computer, use either the EOS Utility ( 482) or a card reader ( 485). Movie files exceeding 4 GB will not be downloaded if you perform image download with the function of the computer's operating system.

Using Movie Digital Zoom

When the recording size is **FHD 29.97P 1PB** (NTSC) or **FHD 25.00P 1PB** (PAL), you can shoot with an approx. 3x to 10x digital zoom.

1 Set the Mode Dial to a mode other than <SCN> or <Q>.

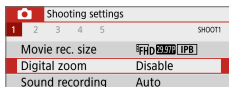

2 Select [Digital zoom].

- Under the [📷] tab, select **[Digital zoom]**, then press <SET>.

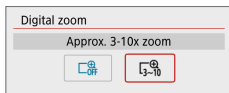

3 Select [Approx. 3-10x zoom].

- Select **[Approx. 3-10x zoom]**, then press <SET>.
- Press the <MENU> button to exit the menu and return to movie shooting.



4 Use digital zoom.

- Press the <▲> <▼> keys.
- ➔ The digital zoom bar will appear.
- Press the <▲> key to zoom in or press the <▼> key to zoom out.
- When you press the shutter button halfway, the camera will focus with **[1-point AF]** (fixed at center).
- To cancel digital zoom, set **[Disable]** in step 2.



- Using a tripod to prevent camera shake is recommended.
- Time-lapse movie, Creative filter, and Movie digital IS cannot be set.
- The maximum ISO speed will be ISO 6400.
- Magnified view is not possible.
- Since Movie digital zoom processes the image digitally, the image will look grainier at higher magnifications. Noise, dots of light, etc. may also become noticeable.
- The scene icon will not be displayed.
- For details, see "Shooting Conditions that Make Focusing Difficult" (📖202).

Movie Digital IS

The camera's Movie digital IS feature reduces camera shake as movies are recorded. With Movie digital IS, images can be stabilized even when using a lens without Image Stabilizer. When using a lens equipped with Image Stabilizer, set the lens's Image Stabilizer switch to <ON>.

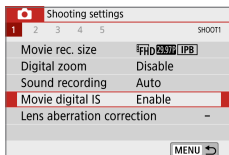

1 Select [Movie digital IS].

- Under the [] tab, select [Movie digital IS], then press <SET>.

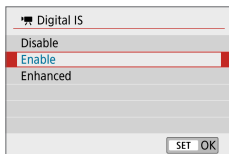

2 Select an item.

- Press the <▲> <▼> keys of the cross keys to select the item, then press <SET>.

- Disable** (OFF)
Image stabilization with Movie digital IS is disabled.
- Enable** (ON)
Camera shake will be corrected. The image will be slightly magnified.
- Enhanced** (ON+)
Compared to when [Enable] is set, stronger camera shake can be corrected. The image will be more magnified.



- Movie digital IS will not function when the lens's optical Image Stabilizer switch is set to <OFF>.
- With a lens whose focal length is longer than 800 mm, Movie digital IS will not function.
- Movie digital IS cannot be set in <SCN> or <Q> mode or when Movie digital zoom, time-lapse movie, or Creative filter is set.
- The wider the angle of view, the more effective the image stabilization will be. The narrower the angle of view, the less effective the image stabilization will be.
- When using a TS-E lens, fish-eye lens, or non-Canon lens, setting Movie digital IS to **[Disable]** is recommended.
- Effects of Movie digital IS are not applied to images during magnified display.
- Since Movie digital IS magnifies the image, the image looks more grainy. Noise, dots of light, etc. may also become noticeable.
- Depending on the subject and shooting conditions, the subject may blur noticeably (the subject momentarily looks out of focus) due to the effects of the Movie digital IS.
- AF point size also changes when you specify Movie digital IS.
- When using a tripod, setting Movie digital IS to **[Disable]** is recommended.
- This feature is not compatible with certain lenses. For details, refer to the Canon website.

Recording HDR Movies

You can reduce the clipped highlights of bright areas, which may make details hard to see, as you shoot movies even in high-contrast scenes. The recording size is **FHD 29.97P IPB** (NTSC) or **FHD 25.00P IPB** (PAL).

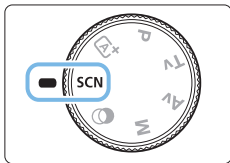

1 Set the Mode Dial to <SCN>.



2 Shoot an HDR movie.



- Since multiple frames are merged to create an HDR movie, certain parts of the movie image may look distorted. During handheld shooting, camera shake may make the distortion look more noticeable. Using a tripod is recommended. Note that even if a tripod is used for shooting, afterimages or noise may become more noticeable when the HDR movie is played back frame-by-frame or in slow-motion compared to normal playback.
- Movie digital zoom, time-lapse movie, and Movie digital IS cannot be set.

Shooting Movies with Creative Filter Effects

In the <Q> (Creative filters) mode, you can shoot movies with one of five filter effects (Dream, Old Movies, Memory, Dramatic B&W, and Miniature effect movie).

The recording size can be set to $\overline{\text{FHD}} \ 29.97\text{P}$ (NTSC) or $\overline{\text{FHD}} \ 25.00\text{P}$ (PAL).

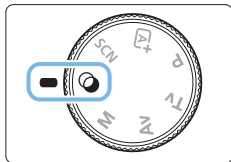

1 Set the Mode Dial to <Q>.

2 Press the <Q> button.

→ The Quick Control screen will appear.

3 Select [Shooting mode].

- Press the <▲> <▼> keys to select [Shooting mode] on the upper left of the screen, then press <SET>.



4 Select a filter effect.

- Press the <▲> <▼> keys to select a filter effect (see page 236), then press <SET>.
- The image will be displayed with the effects of the filter applied.
- For Miniature effect movie, move the AF point to the position to focus on. Move the scene frame if the AF point is outside of it, so that the AF point is aligned with it.

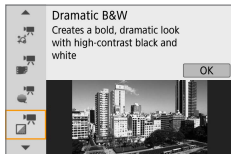



5 Adjust the filter effect level.

- Press the <Q> button and select the icon below [Shooting mode].
- Press the <◀> <▶> keys to adjust the effect, then press <SET>.
- When the Miniature effect movie is set, select the playback speed.

6 Shoot the movie.



- Magnified view is not possible.
- The histogram is not displayed.
- Movie digital zoom, video snapshot, time-lapse movie, and Movie digital IS cannot be set.
- The color gradation of the sky or white walls may not be reproduced correctly. Irregular exposure, irregular colors, or noise may appear.



- In Creative Zone modes, you can set Creative filters with Quick Control (p.227).

Creative Filter Characteristics

● Dream

Creates a soft, dreamy, otherworldly atmosphere. Gives the movie a soft look overall, blurring the periphery of the screen. You can adjust the blurry areas along the screen edges.

● Old Movies

Creates an atmosphere like an old film by adding wavering, scratches, and flickering effects to the image. The top and bottom of the screen are masked in black. You can modify the wavering and scratch effects by adjusting the filter effect.

● Memory

Creates the atmosphere of a distant memory. Gives the movie a soft look overall, reducing brightness of the periphery of the screen. You can modify the overall saturation and the dark areas along the screen edges by adjusting the filter effect.

● Dramatic B&W

Creates an atmosphere of dramatic realism with high-contrast black and white. You can adjust the graininess and black-and-white effect.

-  **Miniature effect movie**

You can shoot movies having a Miniature (diorama) effect. Select the playback speed and shoot.

If you want the image center to look sharp, record the movie without changing any setting.

To move the area where you want to look sharp (miniature effect frame), see “Adjusting Miniature Effect” (📖98). 1-point AF is used as the AF method. Positioning the miniature effect frame over the AF point before shooting is recommended. During shooting, neither the AF point nor the miniature effect frame will be displayed.

In step 5, set the playback speed to **[5x]**, **[10x]**, or **[20x]** and shoot.

Playback Speed and Length (for 1-minute movie)

Speed	Playback Length
5x	Approx. 12 sec.
10x	Approx. 6 sec.
20x	Approx. 3 sec.



< > (Miniature Effect Movies)

- Sound will not be recorded.
- Movie Servo AF will not function.
- Miniature effect movies whose playback time is shorter than 1 sec. cannot be edited (📖299).

Shooting Time-lapse Movies

Still photos shot at a set interval can be stitched together automatically to create a 4K or Full HD time-lapse movie. A time-lapse movie shows how a subject changes in a much shorter period of time than the actual time it took. It is effective for a fixed-point observation of changing scenery, growing plants, etc.

Time-lapse movies will be recorded in MP4 format at the following quality: $\frac{4k}{29.97P}$ $[ALL-I]$ (NTSC)/ $\frac{4k}{25.00P}$ $[ALL-I]$ (PAL) for 4K shooting, and $\frac{FHD}{29.97P}$ $[ALL-I]$ (NTSC)/ $\frac{FHD}{25.00P}$ $[ALL-I]$ (PAL) for Full HD shooting.

1 Set the Mode Dial to a mode other than <SCN> or <Q>.

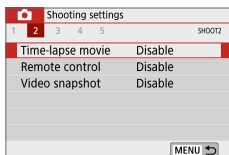

2 Select [Time-lapse movie].

- Under the [] tab, select [Time-lapse movie], then press <SET>.

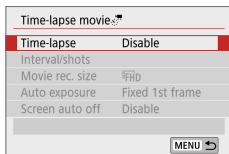

3 Select [Time-lapse].

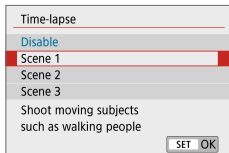

4 Select a scene.

- Select a scene to suit the shooting situation.
- For greater freedom when setting the shooting interval and number of shots manually, select [Custom].

5 Select [Interval/shots].

- Select [Interval/shots], then press <SET>.

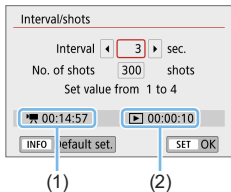

6 Set the shooting interval.

- Select **[Interval]** (sec.). Use the <◀> <▶> keys to set a value, then press <SET>.
- Refer to **[🕒: Time required]** (1) and **[▶: Playback time]** (2) to set the number.

When [Custom] is set

- Select **[Interval]** (min.:sec.).
- Press <SET> so <⏏> is displayed.
- Set the number, then press <SET>. (Returns to <□>.)
- Select **[OK]** to register the setting.

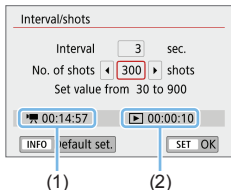

7 Set the number of shots.

- Select **[No. of shots]**. Use the <◀> <▶> keys to set a value, then press <SET>.
- Refer to **[🕒: Time required]** (1) and **[▶: Playback time]** (2) to set the number.

When [Custom] is set

- Select the digit.
- Press <SET> so <⏏> is displayed.
- Set the desired number, then press <SET>. (Returns to <□>.)
- Check that **[▶: Playback time]** is not displayed in red.
- Select **[OK]** to register the setting.



- With **[Scene**]**, available intervals and numbers of shots are restricted, to suit the type of scene.
- If the number of shots is set to 3600, the time-lapse movie will be approx. 2 min. in NTSC and approx. 2 min. 24 sec. in PAL.

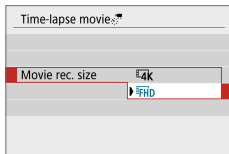

8 Select the desired movie recording size.

- **4K (3840×2160)**

The movie is recorded in 4K quality. The aspect ratio is 16:9. The frame rate is 29.97 fps (29.97P) for NTSC and 25.00 fps (25.00P) for PAL, and movies are recorded in MP4 (MP4) format with ALL-I (ALL-I) compression.

- **FHD (1920×1080)**

The movie will be recorded in Full High-Definition (Full HD) quality. The aspect ratio is 16:9. The frame rate is 29.97 fps (29.97P) for NTSC and 25.00 fps (25.00P) for PAL, and movies are recorded in MP4 (MP4) format with ALL-I (ALL-I) compression.

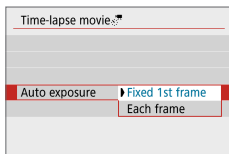

9 Configure [Auto exposure].

- **Fixed 1st frame**

When taking the first shot, metering is performed to set the exposure automatically to match the brightness. The exposure setting for the first shot will be applied to subsequent shots. Other shooting-related settings for the first shot will also be applied for subsequent shots.

- **Each frame**

Metering is also performed for each subsequent shot to set the exposure automatically to match the brightness. Note that if functions such as Picture Style and white balance are set to [Auto], they will be set automatically for each subsequent shot.

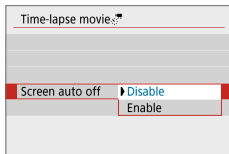

10 Configure [Screen auto off].

- **Disable**

Even during time-lapse movie recording, the image will be displayed. Note that the screen will turn off when approx. 30 min. elapse after the shooting started.

- **Enable**

Note that the screen will turn off when approx. 10 sec. elapse after the shooting started.



- During time-lapse movie recording, you can press the <INFO> button to turn on/off the screen.

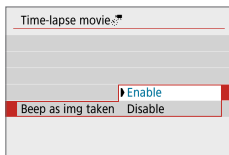

11 Set the beeper.

- Select [Beep as img taken].
- If [Disable] is set, the beeper will not sound for shooting.

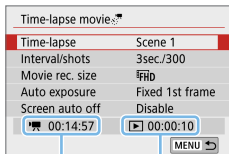

12 Check the settings.

(1) Time required

Indicates the time required to shoot the set number of shots with the set interval. If it exceeds 24 hours, “*** days” will be displayed.

(2) Playback time

Indicates the movie recording time (time required to play back the movie) when creating the time-lapse movie in 4K movie or Full HD movie from the still photos taken with the set intervals.

13 Exit the menu.

- Press the <MENU> button to turn off the menu screen.

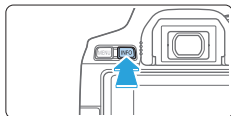

14 Double-check the time required and interval.

- Press the <INFO> button and check again the “Time required (1)” and “Interval (2)” displayed on the screen.



(1)(2)

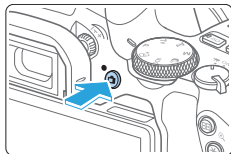

15 Shoot the time-lapse movie.

- Press the <📷> button to start time-lapse movie shooting.
- AF will not work during time-lapse movie shooting.
- While the time-lapse movie is recorded, “●REC” is displayed.
- ➔ When the set number of shots are taken, the time-lapse movie recording ends.
- **To cancel recording time-lapse movies, set [Time-lapse] to [Disable].**



- If the card does not have enough free space to record the set number of shots, **[Playback time]** will be displayed in red. Although the camera can continue shooting, the shooting will stop when the card becomes full.
- If the movie file size exceeds 4 GB with the **[No. of shots]** settings and the card is not formatted in exFAT (📖67), **[Play back time]** will be displayed in red. If you keep shooting in this condition and the movie file size reaches 4 GB, the time-lapse movie recording will stop.



- Do not point the camera toward an intense light source, such as the sun or an intense artificial light source. Doing so may damage the image sensor or the camera's internal components.
- Time-lapse movies cannot be recorded when the camera is connected to a computer with the interface cable, or when an HDMI cable is connected.
- Movie Servo AF will not function.
- Do not zoom the lens during time-lapse movie shooting. Zooming the lens may cause the image to be out of focus, the exposure to change, or the lens aberration correction not to function properly.
- During time-lapse movie shooting, auto power off will not take effect. Also, you cannot adjust the shooting function and menu function settings, play back images, etc.
- Sound is not recorded for time-lapse movies.
- With **[Interval]** set to less than 3 sec. and **[Auto exposure]** set to **[Each frame]**, if the brightness differs greatly from the preceding shot, the camera may not shoot at the set interval.
- Movie digital IS is not available.
- If the time it takes to record to the card exceeds the interval between shots due to the shooting functions set or card performance, some of the shots may not be taken with the set intervals.
- If you connect the camera to a computer with an interface cable and use EOS Utility (EOS software), set **[CAM: Time-lapse movie]** to **[Disable]**. If an option other than **[Disable]** is selected, the camera cannot communicate with the computer.
- During time-lapse movie shooting, the lens's Image Stabilizer will not operate.
- Time-lapse movie shooting ends if the power switch is set to <OFF>, for example, and the setting is changed to **[Disable]**.
- Even if a flash is used, it will not fire.
- The following operations cancel standby for time-lapse movie recording and switch the setting to **[Disable]**.
 - Selecting either **[Clean now]**  under **[P: Sensor cleaning]** or selecting **[Clear all camera settings]** under **[P: Clear settings]**.
 - Turning the Mode Dial.
- If you start time-lapse movie shooting while the white <H> temperature warning (H 215) is displayed, the image quality of the time-lapse movie may decline. It is recommended that you start time-lapse movie shooting after the white <H> disappears (camera's internal temperature decreases).



- Using a tripod is recommended.
- The movie's field of view coverage for both the 4K and Full HD time-lapse movie recording is approx. 100%.
- To cancel the time-lapse movie shooting, press the <📷> button. The time-lapse movie shot so far will be recorded on the card.
- You can play back the shot time-lapse movie with this camera the same way that you play back normal movies.
- If the time required for shooting is more than 24 hours but not more than 48, "2 days" will be indicated. If three or more days are required, the number of days will be indicated in 24-hour increments.
- Even if the time-lapse movie's playback time is less than 1 sec., a movie file will still be created. For **[Playback time]**, "00'00" will be displayed.
- If the shooting time is long, using the household power outlet accessories (sold separately, 📖461) is recommended.
- You can use Wireless Remote Control BR-E1 (sold separately) to start and stop the time-lapse movie shooting.

With Wireless Remote Control BR-E1

- First pair the Wireless Remote Control BR-E1 with the camera (📖410).
- Set **[📷: Remote control]** to **[Enable]**.

Recording Video Snapshots

Record a series of short video snapshots, each a few seconds long, and the camera will combine them to create a video snapshot album that shows these highlights of your trip or event.

Video snapshots are available when the movie recording size is set to **FHD 29.97P 1PB** (NTSC) / **FHD 25.00P 1PB** (PAL).

A video snapshot album can also be played back together with background music (📖337).

Creating a Video Snapshot Album

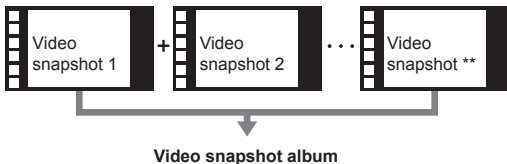

Setting the Video Snapshot Shooting Duration

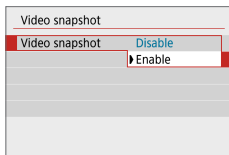
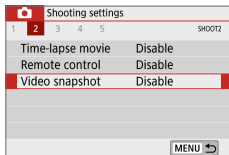

- 1 Set the Mode Dial to a mode other than .
- 2 Select [Video snapshot].
 - Under the [] tab, select [Video snapshot], then press <SET>.
- 3 Select [Enable].
 - Select [Video snapshot], then select [Enable].

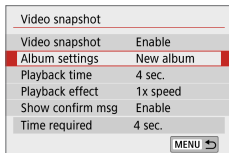

4 Select [Album settings].

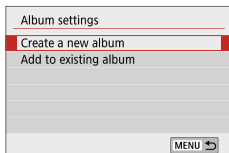

5 Select [Create a new album].

- Read the message and select [OK].

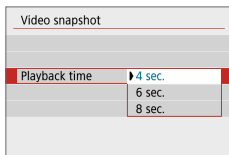

6 Specify the playback time.

- Specify playback time per video snapshot.

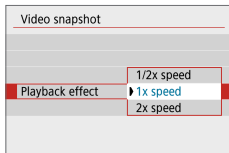

7 Specify the playback effect.

- This setting determines how fast albums are played back.
- Note that with <SCN>, [Playback effect] is not available.

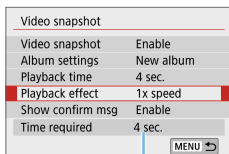

8 Check the required recording time.

- The time required to record each video snapshot is indicated (1), based on the playback time and effect.

(1)

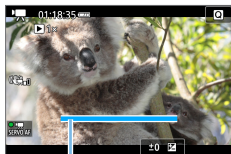

(1)

9 Exit the menu.

- Press the <MENU> button to exit the menu.
- ➔ A blue bar is displayed to indicate the shooting time (1).

Creating a Video Snapshot Album

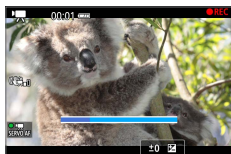

10 Shoot the first video snapshot.

- Press the <CAMERA> button, then shoot.
- ➔ The blue bar indicating the shooting time will gradually decrease. After the set shooting duration elapses, the shooting stops automatically.
- ➔ The confirmation screen will appear (📖248).

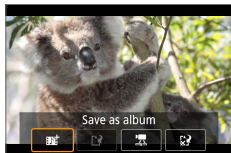

11 Save as a video snapshot album.

- Select [📁 Save as album], then press <SET>.
- The movie clip will be saved as the video snapshot album's first video snapshot.

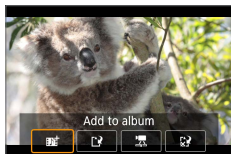

12 Continue to shoot more video snapshots.

- Repeat step 10 to shoot the next video snapshot.
- Select [📁 Add to album], then press <SET>.
- To create another video snapshot album, select [📁 Save as a new album].
- Repeat step 12 as necessary.

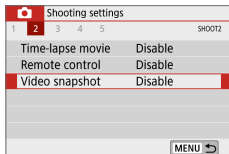

13 Exit the video snapshot shooting.

- Set **[Video snapshot]** to **[Disable]**. To return to normal movie shooting, be sure to set **[Disable]**.
- Press the **<MENU>** button to exit the menu, and return to the normal movie shooting.

Options in Steps 11 and 12

Function	Description
Save as album (Step 11)	The movie clip will be saved as the video snapshot album's first video snapshot.
Add to album (Step 12)	The video snapshot just recorded will be added to the album recorded immediately before.
Save as a new album (Step 12)	A new video snapshot album is created and the movie clip is saved as the first video snapshot. The new album will be a different file from the previously recorded album.
Playback video snapshot (Steps 11 and 12)	The video snapshot just recorded will be played back.
Do not save to album (Step 11)	The video snapshot just recorded will be erased instead of being saved to the album. Select [OK] on the confirmation dialog.
Delete without saving to album (Step 12)	



- If you prefer to record the next video snapshot immediately, set **[Show confirm msg]** under **[📷: Video snapshot]** to **[Disable]**. This setting enables you to record the next video snapshot immediately, without a confirmation message.

Adding to an Existing Album

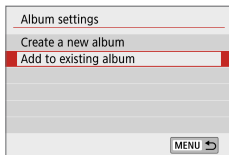

1 Select [Add to existing album].

- Follow step 5 on 246 to select [Add to existing album].

2 Select an existing album.

- Press the <◀> <▶> keys to select an existing album, then press <SET>.
- Select [OK].
- ➔ Certain video snapshot settings will change to match the existing album's settings.

3 Exit the menu.

- Press the <MENU> button to exit the menu.
- ➔ The video snapshot shooting screen will appear.

4 Shoot the video snapshot.

- See “Creating a Video Snapshot Album” (247) to shoot the video snapshot.



- You cannot select an album shot with another camera.



Cautions for Shooting Video Snapshots

- No sound is recorded when you set [Playback effect] to [1/2x speed] or [2x speed].
- Recording time per video snapshot is only approximate. Depending on the frame rate, the shooting duration displayed during playback may not be exact.

Menu Function Settings

Setting items for recording movies are shown on the [CAMERA] and [FUNCTION] tabs when the power switch is set to <CAMERA>.

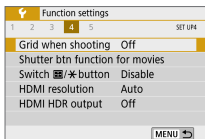
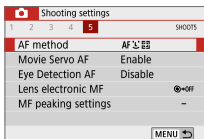
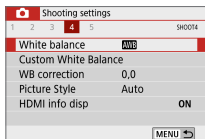
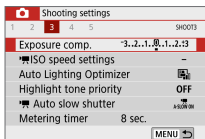
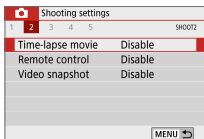
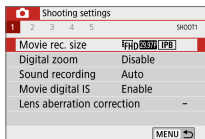

- **Movie recording size (📖228)**

You can set the movie recording size (image size, frame rate, and compression method).

- **Digital zoom (📖231)**

You can use digital zoom for telephoto shooting.

● Sound recording ☆

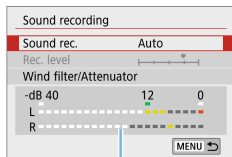

(1)

Normally, the built-in microphones will record the sound in stereo. If the Directional Stereo Microphone DM-E1 (sold separately) is connected to the camera's external microphone IN terminal (📖28), the external microphone will be given the priority.

(1) Level meter

[Sound rec./Rec. level] options

[Auto] : The sound-recording level is adjusted automatically. Auto level control will operate automatically in response to the sound level.

[Manual] : For advanced users. You can adjust the sound-recording level to one of 64 levels. Select **[Rec. level]** and press the <◀> <▶> keys while looking at the level meter to adjust the sound-recording level. Look at the peak hold indicator (approx. 3 sec.), and adjust so that the level meter sometimes lights up on the right of the "12" (-12 dB) mark for the loudest sounds. If it exceeds "0", the sound will be distorted.

[Disable] : Sound will not be recorded.

[Wind filter]

When set to **[Auto]**, it reduces wind noise when there is wind outdoors. This feature works only when you use the built-in microphones for movie shooting. When the wind filter function takes effect, part of the low bass sounds will also be reduced.

[Attenuator]

Automatically suppresses sound distortion caused by loud noises. Even if **[Sound rec.]** is set to **[Auto]** or **[Manual]** for shooting, sound distortion may still result if there is a very loud sound. In such a case, setting it to **[Enable]** is recommended.



- If you use the Wi-Fi (wireless communication) function with an external microphone, the sound noise may be recorded. During sound recording, using the wireless communication function is not recommended.



- In Basic Zone modes, the settings available for **[📷: Sound recording]** will be **[On]/[Off]**. If **[On]** is set, the sound-recording level will be adjusted automatically (same as with **[Auto]**), and the wind filter function will take effect.
- The sound volume balance between L (left) and R (right) cannot be adjusted.
- For both L and R, audio is recorded at a 48 kHz/16-bit sampling rate.

- **Movie digital IS** (📖232)

Enables you to reduce camera shake as movies are recorded.

- **Lens aberration correction** [★] (📖141)

You can set peripheral illumination correction and chromatic aberration correction.

- **Time-lapse movie** (📖238)

You can shoot time-lapse movies.

- **Remote control**

When **[Enable]** is set, you can start or stop movie shooting using Wireless Remote Control BR-E1 (sold separately, 📖463).

If you are using the BR-E1, set the release mode/movie shooting switch to the <📷> position, then press the release button.

- **Video snapshot** (📖245)

You can shoot video snapshots.

- **📷 ISO speed settings** [★] (📖255)

Set the ISO speed and ISO speed range for movies.

- **📷 Auto slow shutter** [★] (📖255)

When recording movies under somewhat low light, you can choose whether to give priority to brightness or smoothness.

- **Metering timer** [★]

You can change how long the exposure setting is displayed (AE lock time).

- **HDMI info disp** [★] (📖256)

You can hide information overlay during HDMI output.





- **AF method**

The AF methods are the same as described on “Focusing with AF” (📖197). You can select **[📷+Tracking]**, **[Spot AF]**, **[1-point AF]**, or **[Zone AF]**.

● **Movie Servo AF**

With this function enabled, the camera focuses on the subject continuously during movie shooting. The default setting is **[Enable]**.

When [Enable] is set:

- The camera focuses on the subject continuously even when you are not pressing the shutter button halfway.
- If you want to keep the focus at a specific point or if you do not want the lens mechanical sound to be recorded, you can temporarily stop Movie Servo AF as follows.
 - Tap [] on the screen's bottom left.
 - Under [: **Custom Functions(C.Fn)**], if [**Shutter/AE lock button**] is set to [**2:AF/AF lock, no AE lock**], you can pause the Movie Servo AF while holding down the < > button. When you let go of the < > button, Movie Servo AF will resume.
- When Movie Servo AF is paused, if you return to movie shooting after operations such as pressing the <MENU> or < > button or changing the AF method, Movie Servo AF will resume.

When [Disable] is set:

- Press the shutter button halfway to focus.



Cautions When [Movie Servo AF] is Set to [Enable]

- Shooting Conditions that Make Focusing Difficult
 - A fast-moving subject approaching or moving away from the camera.
 - A subject moving at a close distance to the camera.
 - For details, see "Shooting Conditions that Make Focusing Difficult" ( 202).
- Since the lens is driven continuously and battery power is consumed, the possible movie shooting time will be shortened.
- With certain lenses, the mechanical sound for focusing may be recorded. In such a case, using Directional Stereo Microphone DM-E1 (sold separately) may reduce such sounds in the movie. Also, using certain USM lenses (for example, the EF-S18-135mm f/3.5-5.6 IS USM) or certain STM lenses (for example, the EF-S18-55mm f/4-5.6 IS STM) will reduce the lens mechanical sound that is recorded.
- Movie Servo AF will pause during zooming or magnified view.
- During movie shooting, if a subject approaches or moves away or if the camera is moved vertically or horizontally (panning), the recorded movie image may momentarily expand or contract (change in image magnification).
- If you want to set the lens's focus mode switch to <MF> during Movie Servo AF, first set the camera's power switch to <ON>.

- **Lens electronic MF** * (📖107)

Can be specified when using lenses that support electronic manual focusing.

- **Grid when shooting**

With **[3x3 井]** or **[6x4 田]**, you can display grid lines to help you level the camera vertically or horizontally before shooting. Also, with **[3x3+diag 米]**, the grid is displayed together with diagonal lines to help you compose with better balance by aligning the intersections over the subject.

Note that the grid is not displayed on the LCD monitor during movie shooting.

- **Shutter button function for movies**

You can set the functions performed by pressing the shutter button halfway or completely during movie shooting.



[Half-press]

- Can be set to **[Meter.+ Servo AF]**, **[Meter.+One-Shot AF]**, or **[Metering only]**. (**[Meter.+One-Shot AF]** is not available for 4K movies.)

[Fully-press]

- Can be set to **[No function]** or **[Start/stop mov rec]**.
With fully pressing the button set to **[Start/stop mov rec]**, you can start/stop movie recording not only by pressing the **<>** or shutter button completely but also by using Remote Switch RS-60E3 (sold separately, 📖463).



- During movie shooting, the **[ : Shutter btn function for movies]** setting overrides any function assigned to the shutter button with **[Shutter/AE lock button]** under **[ : Custom Functions(C.Fn)]**.

ISO Speed During Movie Shooting ☆

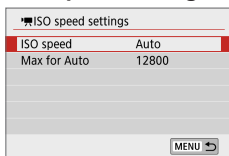

You can set the ISO speed separately for still photo shooting and movie shooting. Set in [**ISO speed settings**] under the [**ISO**] tab.

- **[ISO speed]**

In manual exposure, you can set the ISO speed (📖222).

- **[Max for Auto]**

You can set the maximum limit of the automatic ISO speed for ISO Auto to ISO 6400 or ISO 12800.

Under [**Custom Functions(C.Fn)**], if [**ISO expansion**] is set to [**1:On**], you can select [**H(25600)**].

Auto Slow Shutter ☆

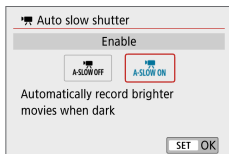

You can choose whether to shoot movies that are brighter and less affected by image noise than when set to [**Disable**] by automatically slowing the shutter speed under low light.

Applies when the frame rate of the movie recording size is **50.94P** or **50.00P**.

- **[Disable]**

Enables you to record movies with smoother, more natural movement, less affected by subject shake than when set to [**Enable**]. Note that under low light, movies may be darker than when set to [**Enable**].

- **[Enable]**

Enables you to shoot brighter movies, less affected by image noise, than when set to [**Disable**] by automatically reducing the shutter speed to 1/30 sec. (NTSC) or 1/25 sec. (PAL) under low light.



- Setting to [**Disable**] is recommended when recording moving subjects under low light, or when afterimages such as trails may occur.

Information Display for HDMI Output ☆

You can configure information display for image output via an HDMI cable.

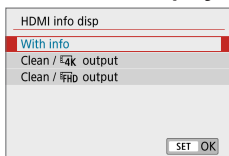

- **[With info]**

The image, shooting information, AF points, and other information is shown on the other device via HDMI. Note that the camera screen goes off.

Recorded movies are saved to the card.

- **[Clean / 4k output]**

HDMI output consists solely of 4K movies. Shooting information and AF points are also displayed on the camera, but no image is recorded to the card. Note that Wi-Fi communication is not available.

- **[Clean / FHD output]**

HDMI output consists solely of Full HD movies. Shooting information and AF points are also displayed on the camera, but no image is recorded to the card. Note that Wi-Fi communication is not available.



General Movie Shooting Cautions

Red Internal Temperature Warning Icon

- If a red icon appears during movie recording, the card may be hot, so stop recording the movie and let the camera cool down before removing the card. (Do not remove the card immediately.)
- If the camera's internal temperature increases due to prolonged movie shooting or under a high ambient temperature, a red icon will appear.
- The red icon indicates that movie shooting will soon be terminated automatically. If this happens, you will not be able to shoot again until the camera's internal temperature decreases. Turn off the power and let the camera rest for a while.
- Shooting a movie at a high temperature for a prolonged period will cause the icon to appear earlier. When you are not shooting, always turn off the camera.

Recording and Image Quality

- If the attached lens has an Image Stabilizer and you set the Image Stabilizer (IS) switch to <ON>, the Image Stabilizer will operate at all times even if you do not press the shutter button halfway. The Image Stabilizer consumes battery power and may shorten the total movie shooting time depending on the shooting conditions. When the Image Stabilizer is not necessary, such as when using a tripod, it is recommended that you set the IS switch to <OFF>.
- The camera's built-in microphones will also record the operation sound and mechanical sound of the camera during shooting. Using the Directional Stereo Microphone DM-E1 (sold separately) may reduce these sounds in the movie.
- Do not connect anything other than an external microphone to the camera's external microphone IN terminal.
- If the brightness changes during autoexposure movie shooting, the movie image may freeze temporarily. In such a case, shoot movies with manual exposure.
- If there is a very bright light source in the image, the bright area may appear black on the LCD monitor. The movie will be recorded almost exactly as it appears on the LCD monitor.
- In low light, noise or irregular colors may appear in the image. The movie will be recorded almost exactly as it appears on the LCD monitor.
- If you play back a movie with other devices, image or sound quality may decline or playback may not be possible (even if the devices support MP4 format).



General Movie Shooting Cautions

Recording and Image Quality

- If you use a card with a slow writing speed, a five-level indicator (1) may appear on the right of the screen during movie shooting. It indicates how much data has not yet been written to the card (remaining capacity of the internal buffer memory). The slower the card, the faster the indicator will climb upward. If the indicator becomes full, movie shooting will stop automatically. If the card has a fast writing speed, the indicator will either not appear or the level (if displayed) will hardly go upward. First, shoot a few test movies to see if the card can write fast enough.



Playback and TV Connection

- If you connect the camera to a TV set (📖305) and shoot a movie, the TV set will not output any sound during the shooting. However, the sound will be properly recorded.

Restrictions on MP4-format Movies

- Note that generally, the following restrictions apply to MP4-format movies.
 - Sound will not be recorded for approx. the last two frames.
 - When you play back movies on Windows, movie images and sound may become slightly out of synchronization.

Handy Features

- Disabling the Beeper (📖260)
- Card Reminder (📖260)
- Setting the Image Review Time (📖261)
- Setting the Auto Power Off Time (📖261)
- Adjusting the LCD Monitor Brightness (📖262)
- Creating and Selecting a Folder (📖263)
- File Numbering Methods (📖265)
- Setting the Copyright Information (📖268)
- Setting the Auto Rotation of Vertical Images (📖270)
- Reverting the Camera to the Default Settings (📖271)
- Turning the LCD Monitor Off/On (📖272)
- Automatic Sensor Cleaning (📖273)
- Appending Dust Delete Data (📖274)
- Manual Sensor Cleaning (📖276)
- HDMI Output Resolution (📖278)
- RAW Playback on an HDR TV (📖279)

Handy Features

Disabling the Beeper

You can prevent the beeper from sounding when focus is achieved, during self-timer shooting, and during touch operations.

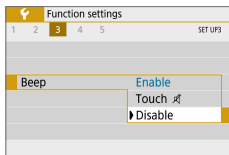

Under the [**F**] tab, select [**Beep**], then press <SET>. Select [**Disable**], then press <SET>.

To silence the beeper only for touch operations, select [**Touch** 🔊].

Card Reminder

This setting prevents shooting if there is no card in the camera.

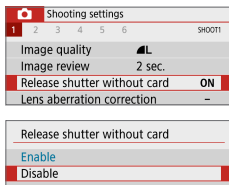

Under the [**C**] tab, select [**Release shutter without card**], then press <SET>. Select [**Disable**], then press <SET>.

If there is no card inserted in the camera and you press the shutter button, “**Card**” will be displayed in the viewfinder, and you cannot release the shutter.

Setting the Image Review Time

You can change how long the image is displayed on the LCD monitor immediately after shooting. If **[Off]** is set, the image will not be displayed immediately after shooting. If **[Hold]** is set, the image review will be displayed up until the **[Auto power off]** time has elapsed.

Note that during image review, if you operate any camera controls such as pressing the shutter button halfway, the image review will end.

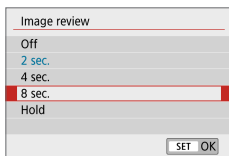

Under the **[📷]** tab, select **[Image review]**, then press <SET>. Select the desired setting, then press <SET>.

Setting the Auto Power Off Time

To save battery power, the camera turns off automatically after a set time of idle operation elapses. When the camera is turned off due to auto power off, you can turn it on again by pressing the shutter button, etc.

If [Disable] is set, either turn off the camera or press the <DISP> button to turn off the LCD monitor to save battery power.

Even if [Disable] is set, the LCD monitor will turn off after the camera is left idle for approx. 30 min. To turn on the LCD monitor again, press the <DISP> button.

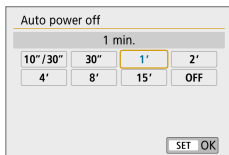

Under the **[🔋]** tab, select **[Auto power off]**, then press <SET>. Select the desired setting, then press <SET>.



- If **[10 sec/30 sec]** is set, the camera will turn off after it is left idle for approx. 10 sec. When setting functions or during Live View shooting, movie recording, image playback, etc., the auto power off time will be approx. 30 sec.

Adjusting the LCD Monitor Brightness

You can adjust the brightness of the LCD monitor to make it easier to view.

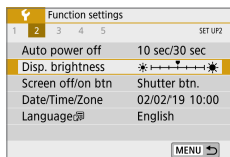

Under the [**F**] tab, select [**Disp. brightness**], then press <SET>. Press the <◀> <▶> keys to adjust the brightness on the adjustment screen, then press <SET>.

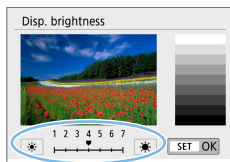

When checking the exposure of an image, set the LCD monitor brightness to 4 and prevent the ambient light from affecting the image.

Creating and Selecting a Folder

You can freely create and select the folder where the captured images are to be saved.

This operation is optional since a folder will be created automatically for saving captured images.

Creating a Folder

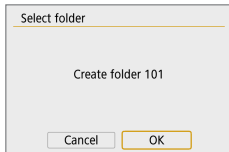
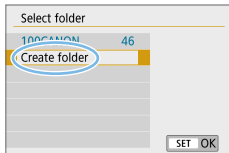
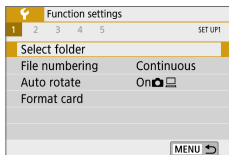

1 Select [Select folder].

- Under the [**1**] tab, select [**Select folder**], then press <SET>.

2 Select [Create folder].

- Select [**Create folder**], then press <SET>.

3 Create a new folder.

- Select [**OK**], then press <SET>.
- ➔ A new folder with the folder number increased by one is created.

Selecting a Folder

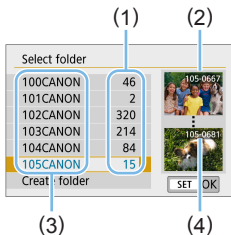

- With the folder selection screen displayed, select a folder and press <SET>.
- ➔ The folder where the captured images will be saved is selected.
- Subsequently captured images will be recorded into the selected folder.

- (1) Number of images in folder
- (2) Lowest file number
- (3) Folder name
- (4) Highest file number



Folders

- As with “100CANON” for example, the folder name starts with three digits (the folder number) followed by five alphanumeric characters. A folder can contain up to 9999 images (file number 0001 - 9999). When a folder becomes full, a new folder with the folder number increased by one is created automatically. Also, if manual reset (📖267) is executed, a new folder will be created automatically. Folders numbered from 100 to 999 can be created.

Creating Folders with a Computer

- With the card open on the screen, create a new folder named “DCIM”. Open the DCIM folder and create as many folders as necessary to save and organize your images. The folder name must follow the format “100ABC_D”. The first three digits are always the folder number from 100 to 999. The last five characters can be any combination of upper- and lower-case letters from A to Z, numerals, and the underscore “_”. The space cannot be used. Also note that two folder names cannot share the same three-digit folder number (for example, “100ABC_D” and “100W_XYZ”), even if the last five characters in each name are different.

File Numbering Methods

The image files will be numbered from 0001 to 9999 in the order the images are taken, then saved in a folder. You can change how the file number is assigned.

The file number will appear on your computer in this format:

IMG_0001.JPG.

File numbering	
Numbering	Continuous
Manual reset	

In **[File numbering]** under the **[F]** tab, select **[Numbering]**, then press **<SET>**.

The available settings are described below. Select the option, then press **<SET>**.

- **[Continuous]:** When you wish to continue the file numbering sequence even after the card is replaced or a new folder is created.

Even after you replace the card or create a new folder, the file numbering continues in sequence up to 9999. This is useful when you want to save images numbered anywhere between 0001 to 9999 on multiple cards or in multiple folders into one folder on a computer. If the replacement card or existing folder already contains images recorded previously, the file numbering of the new images may continue from the file numbering of the existing images on the card or in the folder. If you want to use continuous file numbering, it is recommended that you use a newly-formatted card each time.

File numbering after replacing the card

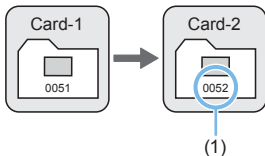

(1) Next sequential file number

File numbering after creating a folder

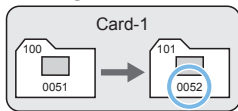

- **[Auto reset]:** When you wish to restart the file numbering from **0001** each time the card is replaced or a new folder is created.

When you replace the card or create a folder, the file numbering restarts from 0001 for the new images saved. This is useful if you want to organize images by cards or folders.

If the replacement card or existing folder already contains images recorded previously, the file numbering of the new images may continue from the file numbering of the existing images on the card or in the folder. If you want to save images with the file numbering starting from 0001, use a newly formatted card each time.

File numbering after replacing the card

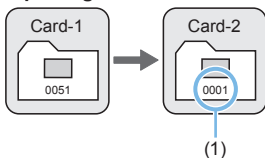

File numbering after creating a folder

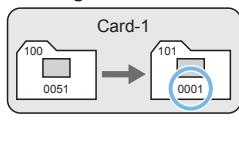

(1) File numbering is reset

- **[Manual reset]:** When you wish to reset the file numbering to 0001 or to start from file number 0001 in a new folder.

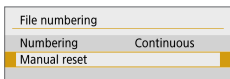

In **[File numbering]** under the **[F]** tab, select **[Manual reset]**, then select **[OK]** on the confirmation dialog.

When you reset the file numbering manually, a new folder is created automatically and the file numbering of images saved to that folder starts from 0001.

This is useful, for example, if you want to use different folders for the images taken yesterday and the ones taken today. After the manual reset, the file numbering returns to continuous or auto reset. (There will be no manual reset confirmation dialog.)



- If the file number in folder 999 reaches 9999, shooting will not be possible even if the card still has storage capacity. The LCD monitor will display a message telling you to replace the card. Replace it with a new card.



- For both JPEG and RAW images, the file name will start with "IMG_". Movie file names will start with "MVI_". The extension will be ".JPG" for JPEG images, ".CR3" for RAW images, and ".MP4" for movies.



Setting the Copyright Information

When you set the copyright information, it will be appended to the image as Exif information.

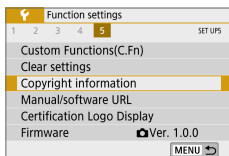

1 Select [Copyright information].

- Under the [**f**] tab, select [**Copyright information**], then press <SET>.



2 Select the item to be set.

- Select [**Enter author's name**] or [**Enter copyright details**], then press <SET>.

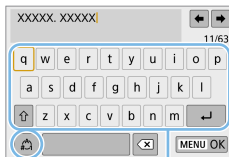

3 Enter text.

- Press the <⬆> cross keys to move the and select the desired character. Then press <SET> to enter it.
- You can enter up to 63 characters.
- To delete single characters, select [**X**] or press the <🗑️> button.
- By selecting [**🏠**], you can change the input mode.
- To move the cursor, select [**⬅**] or [**➡**] in the upper right, or turn the <🕒> dial.
- To cancel the text entry, press the <MENU> button, then select [**Cancel**].

(1) Input mode

(2) Character palette

4 Exit the setting.

- After entering the text, press the <MENU> button, then select **[OK]**.
- ➔ The set information is saved.

Checking the Copyright Information

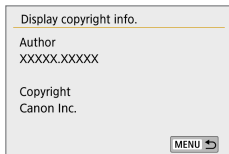

When you select **[Display copyright info.]** in step 2, you can check the **[Author]** and **[Copyright]** information that you entered.

Deleting the Copyright Information

When you select **[Delete copyright information]** in step 2, you can delete the **[Author]** and **[Copyright]** information.



- If the entry for “Author” or “Copyright” is long, it may not be displayed entirely when you select **[Display copyright info.]**.



- You can also set or check the copyright information with EOS Utility (EOS software, 482).



Setting the Auto Rotation of Vertical Images



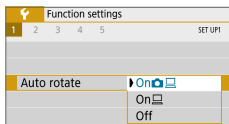





Images shot in vertical orientation are rotated automatically to the proper orientation for viewing, so they will not be displayed in horizontal orientation when played back on the camera's LCD monitor or viewed on a computer screen. You can change the setting of this feature.



Under the **[F]** tab, select **[Auto rotate]**, then press **<SET>**. The available settings are described below. Select the option, then press **<SET>**.

- **[On  ** :The vertical image is automatically rotated during playback on both the camera's LCD monitor and on the computer screen.
- **[On **] :The vertical image is automatically rotated only on the computer screen.
- **[Off]** :The vertical image is not automatically rotated.

? FAQ

- **The vertical image is not rotated during the image review just after shooting.**
Press the **<▶>** button and the image playback will display the rotated image.
- **[On  ] is set, but the image does not rotate during playback.**
Auto rotate will not work with vertical images captured while **[Auto rotate]** was set to **[Off]**. If the vertical image is taken while the camera is pointed up or down, the image may not be rotated automatically for playback. In such a case, see Rotating the Image (287).
- **On the camera's LCD monitor, I want to rotate an image captured when [On ] had been set.**
Set **[On  **, then play back the image. It will be rotated.
- **The vertical image does not rotate on the computer screen.**
The software used is not compatible with image rotation. Use EOS software instead.



Reverting the Camera to the Default Settings

The camera's shooting function settings and menu settings can be reverted to their defaults. This option is available in Creative Zone modes.

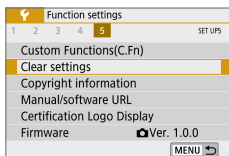

1 Select [Clear settings].

- Under the [**f**] tab, select [**Clear settings**], then press <SET>.

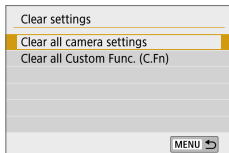

2 Select [Clear all camera settings].

- Select [**Clear all camera settings**], then press <SET>.



3 Select [OK].

- Select [**OK**], then press <SET>.

? FAQ

• Clearing all camera settings

After the procedure above, select [**Clear all Custom Func. (C.Fn)**] in [**f**: **Clear settings**] to clear all the Custom Function settings (📖446).

Turning the LCD Monitor Off/On

You can set the camera so that the LCD monitor does not turn off and on as you press the shutter button halfway (or press the <✳> button).

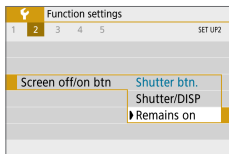

Under the [**☛**] tab, select [**Screen off/on btn**], then press <SET>. The available settings are described below. Select the option, then press <SET>.

- **[Shutter btn.]** :When you press the shutter button halfway, the display will turn off. When you let go of the shutter button, the display will turn on.
- **[Shutter/DISP]** :When you press the shutter button halfway, the display will turn off. The display will remain off even after you let go of the shutter button. To turn on the display, press the <DISP> button.
- **[Remains on]** :Display remains on even when you press the shutter button halfway. To turn off the display, press the <DISP> button.

Automatic Sensor Cleaning

Whenever you set the power switch to <ON> or <OFF>, the Self Cleaning Sensor Unit is activated to automatically shake off the dust on the front of the sensor. Normally, you need not pay attention to this operation. However, you can manually perform sensor cleaning or can disable this unit as follows.

Activating the Sensor Cleaning Manually

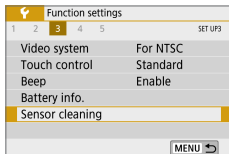

1 Select [Sensor cleaning].

- Under the [**⚙**] tab, select [**Sensor cleaning**], then press <SET>.

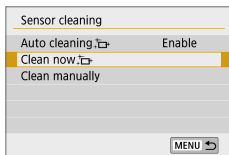

2 Select [Clean now **⏏**].

- Select [**Clean now **⏏****], then press <SET>.
- Select [**OK**], then press <SET>.
- ➔ The screen will indicate that the sensor is being cleaned. (A small sound may be heard.) Although there will be a mechanical sound of the shutter during the cleaning, no picture is taken.



- When Multi Shot Noise Reduction is set, [**Clean now **⏏****] cannot be selected.



- For best results, perform the sensor cleaning with the camera placed upright and stable on a table or other flat surface.
- Even if you repeat the sensor cleaning, the result will not improve much. Immediately after the sensor cleaning is finished, the [**Clean now **⏏****] option remains disabled temporarily.
- Dots of light may appear on the shooting screen if the sensor is affected by cosmic rays or similar factors. By selecting [**Clean now **⏏****], their appearance may be suppressed (📖475).

Disabling Automatic Sensor Cleaning

- In step 2, select [**Auto cleaning **⏏****] and set it to [**Disable**].
 - ➔ The sensor will no longer be cleaned when you set the power switch to <ON> or <OFF>.

Appending Dust Delete Data



Normally, the Self Cleaning Sensor Unit will eliminate most of the dust that may be visible on captured images. However, for the case where visible dust still remains, you can append the Dust Delete Data to the image for erasing the dust spots later. The Dust Delete Data is used by Digital Photo Professional (EOS software, 482) to erase the dust spots automatically.

Preparation

- Prepare a solid white object such as a sheet of paper.
- Set the lens focal length to 50 mm or longer.
- Set the lens's focus mode switch to **<MF>** and set the focus to infinity (∞). If the lens has no distance scale, rotate the camera to face toward you and turn the focusing ring clockwise all the way.

Obtaining the Dust Delete Data

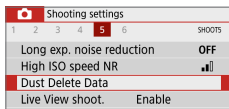

1 Select [Dust Delete Data].

- Under the [] tab, select [Dust Delete Data], then press **<SET>**.

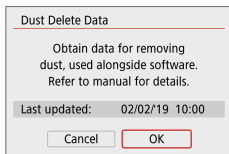

2 Select [OK].

- When you select [**OK**] and press **<SET>**, the automatic sensor cleaning will be performed, then a message will appear. Although there will be a mechanical sound of the shutter during the cleaning, no picture is taken.

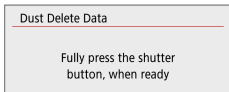
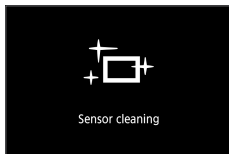

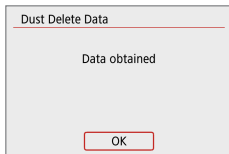
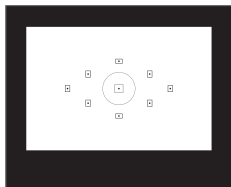

3 Shoot a solid-white object.

- At a distance of 20 cm–30 cm (0.7 ft.–1.0 ft.), fill the viewfinder with a patternless, solid-white object and take a picture.
- ➔ The picture will be taken in aperture-priority AE mode at an aperture of $f/22$.
- Since the image will not be saved, the data can still be obtained even if there is no card in the camera.
- ➔ When the picture is taken, the camera will start collecting the Dust Delete Data. When the Dust Delete Data is obtained, a message will appear. Select **[OK]** and the menu will reappear.
- If the data is not obtained successfully, an error message will appear. After reviewing the information in Preparation (📖 274), select **[OK]**, then shoot again.

Dust Delete Data

After the Dust Delete Data is obtained, it is appended to all the JPEG and RAW images captured thereafter. Before an important shoot, it is recommended that you update the Dust Delete Data by obtaining it again. For details about using Digital Photo Professional (EOS software) to erase dust spots automatically, refer to the Digital Photo Professional Instruction Manual.

The Dust Delete Data appended to the image is so small that it hardly affects the image file size.



- Be sure to use a solid-white object such as a new sheet of white paper. If the object has any pattern or design, it may be recognized as dust data and affect the accuracy of the dust deletion with EOS software.

Manual Sensor Cleaning



Dust that could not be removed by the automatic sensor cleaning can be removed manually with a commercially-available blower, etc. Before cleaning the sensor, detach the lens from the camera.

The image sensor is extremely delicate. If the sensor needs to be cleaned directly, having it done by a Canon Service Center is recommended.

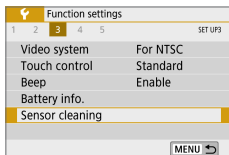

1 Select [Sensor cleaning].

- Under the [**F**] tab, select [**Sensor cleaning**], then press <SET>.

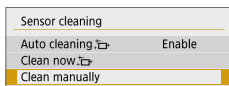

2 Select [Clean manually].

- Select [**Clean manually**], then press <SET>.

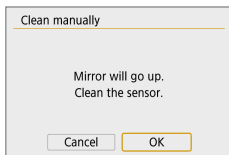

3 Select [OK].

- Select [**OK**], then press <SET>.
- ➔ In a moment, the reflex mirror will lock up and the shutter will open.

4 Clean the sensor.

5 End the cleaning.

- Set the power switch to <OFF>.



- If you use a battery, make sure it is fully charged.



- Using the household power outlet accessories (sold separately,  461) is recommended.



- When Multi Shot Noise Reduction is set, **[Clean manually]** cannot be selected.
- **While cleaning the sensor, never do any of the following. If the power is cut off, the shutter will close and the shutter curtains and image sensor may get damaged.**
 - **Setting the power switch to <OFF>.**
 - **Removing or inserting the battery.**
- The surface of the image sensor is extremely delicate. Clean the sensor with care.
- Use a plain blower without any brush attached. A brush can scratch the sensor.
- Do not insert the blower tip inside the camera beyond the lens mount. If the power is turned off, the shutter will close and the shutter curtains or reflex mirror may get damaged.
- Never use pressurized air or gas to clean the sensor. Pressurized air may damage the sensor, and sprayed gas may freeze on the sensor and scratch it.
- If the battery level becomes low while cleaning the sensor, the beeper will sound as a warning. Stop cleaning the sensor.
- If a smudge that cannot be removed with a blower remains, having the sensor cleaned by a Canon Service Center is recommended.

HDMI Output Resolution

Set the image output resolution used when the camera is connected to a television or external recording device with an HDMI cable.

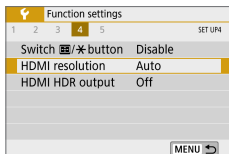

1 Select [HDMI resolution].

- Under the [**F**] tab, select [**HDMI resolution**], then press <SET>.

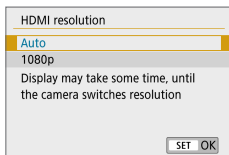

2 Select an item.

- Press the <▲> <▼> keys to select the item, then press <SET>.

• Auto

The images will automatically be displayed at the optimum resolution matching the connected TV set.

• 1080p

Output at 1080p resolution. Select if you prefer to avoid display or delay issues when the camera switches resolution.

RAW Playback on an HDR TV

You can view RAW images in HDR by connecting the camera to an HDR TV.

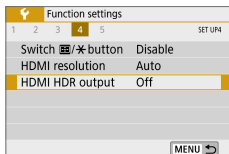

1 Select [HDMI HDR output].

- Under the [**F**] tab, select [**HDMI HDR output**], then press <SET>.

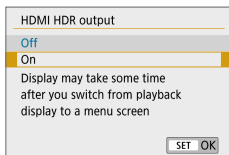

2 Select [On].

- Press the <▲> <▼> keys to select [**On**].



- Make sure the HDR TV is set up for HDR input. For details on how to switch inputs on the TV, refer to the TV manual.
- Depending on the TV used, images may not look as expected.
- Some image effects and information may not be displayed on an HDR TV.

Image Playback

This chapter describes advanced usage of the playback methods described in “Basic Shooting and Image Playback” (📖 69), how to play back and erase the captured images (still photos/movies), how to view them on a TV screen, and other playback-related functions.

Images shot and saved with another device

The camera may not be able to properly display images captured with a different camera, edited with a computer, or that have had their file names changed.

Searching for Images Quickly

Display Multiple Images on One Screen (Index Display)

Search for images quickly with the index display showing 4, 9, 36, or 100 images on one screen.

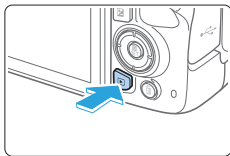

1 Play back the image.

- When you press the <▶> button, the last image captured will be displayed.



2 Switch to the index display.

- Press the <⊞> button.
- ➔ The 4-image index display will appear. The selected image is highlighted with an orange frame.
- Pressing the <⊞> button will switch the display as follows: 9 images → 36 images → 100 images.
- Pressing the <⊞> button will switch the display as follows: 100 images → 36 images → 9 images → 4 images → 1 image.



3 Select an image.

- Press the <⬆> cross keys to move the orange frame to select the image.
- Turning the <⊞> dial will display image(s) on the next or previous screen.
- Press <SET> in the index display to display the selected image in the single-image display.

Jumping through Images (Jump Display)

In the single-image display, you can turn the  dial to jump through the images forward or backward according to the jump method set.

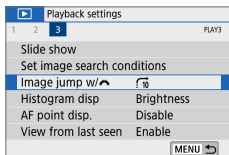

1 Select [Image jump w/].

- Under the [▶] tab, select [Image jump w/ , then press <SET>.

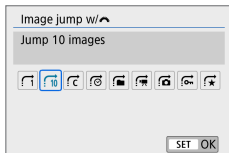

2 Select the jump method.

- Press the <⬆> cross keys to select the jump method, then press <SET>.

: Display images one by one

: Jump 10 images

: Jump images by the specified number

: Display by date

: Display by folder

: Display movies only



: Display stills only

: Display protected images only

: Display by image rating (📖288)

Turn the  dial to select.



- With [Jump images by the specified number], you can turn the  dial to select the number of images you want to jump (1 to 100).
- To search images by shooting date, select [Date].
- To search images by folder, select [Folder].
- If the card contains both movies and still photos, select [Movies] or [Stills] to display one or the other.
- If no images match the selected [Rating], you cannot browse through the images with the  dial.



(1)

(2)

3 Browse by jumping.

- Press the <▶> button to play back images.
 - In the single-image display, turn the <⚙> dial.
- ➔ You can browse by the set method.
- (1) Jump method
 - (2) Playback position

Magnifying Images

You can magnify a captured image by approx. 1.5x to 10x on the LCD monitor.

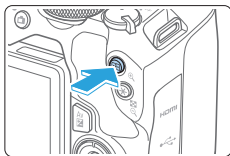

(1)

1 Magnify the image.

- Press the $\langle \text{Q} \rangle$ button during image playback.
- ➔ The image will be magnified. The magnified area position (1) will be displayed on the lower right of the screen.
- If you hold down the $\langle \text{Q} \rangle$ button, the image will be magnified until it reaches the maximum magnification.
- Press the $\langle \text{Q} \rangle$ button to reduce the magnification. If you hold down the button, the magnification will be reduced to the single-image display.



2 Scroll around the image.

- Press the $\langle \text{D} \rangle$ cross keys to scroll the magnified image in the direction pressed.
- To exit magnified view, press the $\langle \text{P} \rangle$ button and the single-image display will reappear.



- Turn the $\langle \text{D} \rangle$ dial to view another image while maintaining the magnified view.
- A movie cannot be magnified.

Playing Back with the Touch Screen

The LCD monitor is a touch-sensitive panel that you can touch with your fingers for various playback operations. **First, press the <▶> button to play back images.**

Browsing Images



Swipe with one finger.

- With single-image display, touch the LCD monitor with **one finger**. You can browse to the next or previous image by swiping your finger to the left or right. Swipe to the left to see the next (newer) image, or swipe to the right to see the previous (older) image.
- With index display, also touch the LCD monitor with **one finger**. You can browse to the next or previous screen by swiping your finger up or down. Swipe up to see the next (newer) images or swipe down to see the previous (older) images. When you select an image, the orange frame will appear. Tap on the image again to display it as a single image.

Jumping through Images (Jump Display)

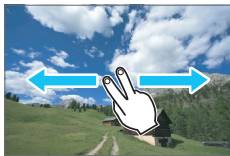

Swipe with two fingers.

Touch the LCD monitor with **two fingers**. When you swipe two fingers to the left or right, you can jump through images with the method set in **[Image jump w/ 🌓]** under the **[▶]** tab.

Reducing Image (Index Display)



Pinch two fingers.

Touch the screen with two fingers spread apart, and pinch your fingers together on the screen.

- Each time you pinch your fingers, the single-image display will change to the index display.
- When you select an image, the orange frame will appear. Tap on the image again to display it as a single image.

Magnifying Image



Spread two fingers apart.

Touch the screen with two fingers together, then spread your fingers apart on the screen.

- As you spread your fingers, the image will be magnified.
- The image can be magnified up to approx. 10x.

Double-tap.

- When you double-tap on the image with your finger, the recorded image's pixels will be displayed at approx. 100% centered around the point that you tapped on.
- To return to the single-image display, double-tap on the image again.



- In the index display, you cannot magnify the image by double-tapping.



- You can scroll around the image by dragging your fingers.
- To reduce the image, pinch your fingers together on the screen.
- By tapping on [↶], you can return to the single-image display.

Rotating the Image

You can use this feature to rotate the displayed image to the desired orientation.

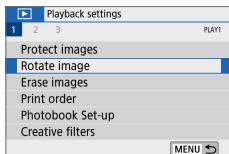

1 Select [Rotate image].

- Under the [] tab, select [Rotate image], then press <SET>.

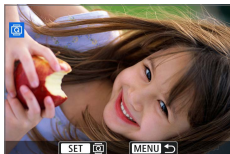

2 Select an image.

- Press the <<> <>> keys to select the image to be rotated.
- You can also select an image in the index display (281).

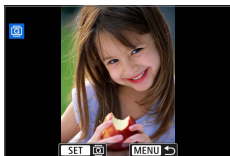

3 Rotate the image.

- Each time you press <SET>, the image will rotate clockwise as follows: 90° → 270° → 0°.
- To rotate another image, repeat steps 2 and 3.
- To exit and return to the menu, press the <MENU> button.



- If you set [: Auto rotate] to [On] (270) before taking vertical shots, you need not rotate the image as described above.
- If the rotated image is not displayed in the rotated orientation during image playback, set [: Auto rotate] to [On].
- A movie cannot be rotated.

Setting Ratings

You can rate images (still photos and movies) with one of the five rating marks: [★]/[☆]/[☆☆]/[☆☆☆]/[☆☆☆☆]. This function is called rating.

* Rating images can help you organize them.

Rating a Single Image

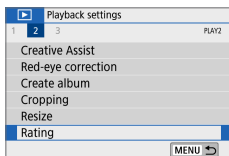

1 Select [Rating].

- Under the [▶] tab, select [Rating], then press <SET>.

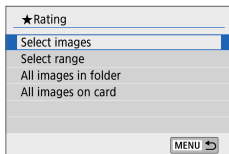

2 Select [Select images].

- ➔ An image is displayed.



3 Select the image to be rated.

- Press the <◀> <▶> keys to select an image to be rated, then press <SET>.
- By pressing the <⏏> button, you can select images from a three-image display. To return to the single-image display, press the <⏏> button.



4 Rate the image.

- Press the <▲> <▼> keys to select a rating.
- ➔ When you append a rating mark for the image, the number beside the set rating will increase by one.
- To rate another image, repeat steps 3 and 4.

Specifying the Range

You can specify the range of images to rate all the images in the range at once.

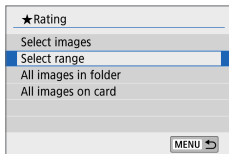

1 Select [Select range].

- Select **[Select range]** in [**▢**: Rating], then press <SET>.



2 Specify the range of images.

- Select the first image (start point), then press <SET>.
- Select the last image (end point), then press <SET>.
- ➔ The [**✓**] icon will appear on the selected images.
- To cancel the selection, repeat this step.
- Pressing the <MENU> button before you select an end point will clear the [**✓**] icons.

3 Confirm the range.

- Press the <MENU> button.



4 Rate the image.

- Turn the <★> dial to select a rating mark, then select **[OK]**.

Specifying All Images in a Folder or on a Card

You can rate all the images in a folder or on a card at once.

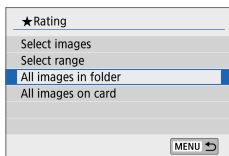

- When you select **[All images in folder]** or **[All images on card]** in []: Rating], all the images in the folder or on the card will be specified.



- Turn the < > dial to select a rating mark, then select **[OK]**.
- To cancel the rating, select the **[OFF]** rating mark.



- A total of up to 999 images of a given rating can be displayed. If there are 1000 or more images with a given rating, **[###]** will be displayed.

Taking Advantage of Ratings

- With []: **Image jump w/** , you can display only the images having a specific rating.
- Depending on the computer's operating system, you can see each file's rating as part of the file information display or in the provided, standard image viewer (JPEG images only).

Filtering Images for Playback

You can search for images by specifying the conditions and display the filtered images. You can also play back in a slide show, protect, or erase all the found images at once.

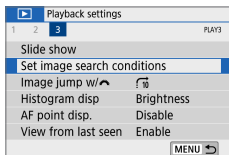

1 Select [Set image search conditions].

- Under the [] tab, select [Set image search conditions], then press <SET>.



2 Set the search conditions.

- Press the <▲> <▼> keys to select the condition.
- Press the <◀> <▶> keys to set the setting.
- To cancel the condition, press the <INFO> button.
- You can even set all the conditions.
- To cancel all the conditions, press the <🗑> button.

Item	Setting
★ Rating	Images with the selected rating mark will be displayed.
📅 Date	Images taken on the selected shooting date will be displayed.
📁 Folder	Images in the selected folder will be displayed.
🔒 Protect	“Protected” or “Unprotected” images on the card will be displayed.
📁 Type of file	Image files of the selected type will be displayed. The settable file types are [📷 Stills], [📷 (RAW)], [📷 (RAW, RAW+JPEG)], [📷 (RAW+JPEG)], [📷 (RAW+JPEG, JPEG)], [📷 (JPEG)], and [🎬 Movies].

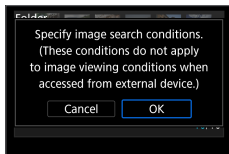

3 Implement the search conditions.

- Press <SET>.
- ➔ Read the message that appears and select [OK].

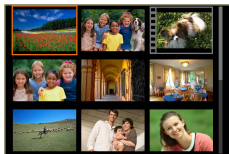

4 Display the found images.

- Press the <▶> button to play back images.
- ➔ Images that match the set conditions will appear in a yellow frame.



- If there are no images matching the search conditions, pressing <SET> on the screen in step 2 will not enable [OK]. (Cannot proceed to step 3.)



- Even if [**⏻**: Auto power off] is set to [4 min.] or less, the auto power off time will be approx. 6 min. when the search conditions screen is displayed.
- With the found images displayed, you can also perform operations (protect, erase, print order, photobook set-up, rating, and slide show) for all the found images at once.
- The display of found images will be automatically canceled with the following operations:
 - Shooting is performed.
 - Auto power off takes effect.
 - Setting the power switch to <OFF>.
 - Formatting the SD card.
 - Adding an image (such as when a captured image is saved as a new image after applying a filter effect, resizing, or cropping).
 - When there are no longer any images matching the search conditions.

Quick Control for Playback

During playback, you can press the <Q> button to set the following: [🔒: Protect images], [🔄: Rotate image], [★: Rating], [🎨: Creative filters], [📏: Resize (JPEG images only)], [✂️: Cropping], [🔍: Image jump w/⚙️], [🔎: Image search], [📱: Send images to smartphone*], and [👉: Creative Assist (RAW images only)].

For movies, only the following can be set: [🔒: Protect images], [★: Rating], [🔍: Image jump w/⚙️], [🔎: Image search], [📱: Send images to smartphone*], or [▶️: Play movie].

* Not selectable if [Disable] is set for [Wi-Fi] under [📶: Wi-Fi settings].



1 Press the <Q> button.

- During image playback, press the <Q> button.
- ➔ The Quick Control options will appear.

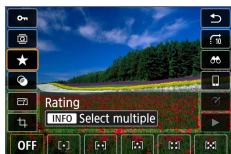

2 Select an item and set it.

- Press the <▲> <▼> keys to select a function.
- ➔ The name and setting of the selected function are displayed at the bottom of the screen.
- Press the <◀> <▶> keys to set the function.
- For Protect images (📖307) and Rating (📖288), press <INFO> to select multiple images.
- For Creative filters (📖329), Resize (📖338), Cropping (📖340), Image search (📖291), Send images to smartphone (📖363), and Creative Assist (📖332), press <SET> and set the function.
- Image jump w/⚙️ (📖282): To specify the number of images for Jump display or Rating (📖288), press <INFO>.

- To cancel, press the <MENU> button.

3 Exit the setting.

- Press <SET> to exit Quick Control.



- To rotate an image (📖287), set [**📷: Auto rotate**] to [**On** 📷]. If [**📷: Auto rotate**] is set to [**On** 📷] or [**Off**], the [**📷 Rotate image**] setting will be recorded to the image, but the camera will not rotate the image for display.



- For images taken with another camera, the options you can select may be restricted.

Enjoying Movies

The three main ways to play back and enjoy movies are as follows:

Playback on a TV Set 305)

By connecting the camera to a TV set with an HDMI cable, you can play back the captured movies and still photos on the TV set.

-  ● Since hard disk recorders do not have an HDMI IN terminal, the camera cannot be connected to a hard disk recorder with an HDMI cable.
- Even if the camera is connected to a hard disk recorder with a USB cable, movies and still photos cannot be played back or saved.
- Movies cannot be played back on devices that do not support MP4-format movie files.

Playback on the Camera's LCD Monitor 296– 303)

You can play back movies on the camera's LCD monitor. You can also edit out the movie's first and last scenes and can play back the still photos or movies on the card in an automatic slide show.

-  ● A movie edited with a computer cannot be rewritten to the card and played back with the camera.

Playback and Editing with a Computer

The movie files recorded on the card can be transferred to a computer and played back or edited with pre-installed or general-purpose software compatible with the movie's recording format.

-  ● To play back or edit a movie with commercially-available software, use software compatible with MP4-format movies. For details on commercially-available software, contact the software manufacturer.

Playing Back Movies

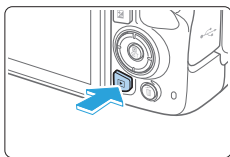

1 Play back the image.

- Press the <▶> button to display an image.



2 Select a movie.

- Press the <◀> <▶> keys to select the movie to be played back.
- In the single-image display, the <SET [camera icon]> icon displayed on the upper left indicates a movie.
- In the index display, perforations at the left edge of a thumbnail indicate a movie. **As movies cannot be played back from the index display, press <SET> to switch to the single-image display.**

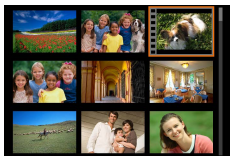

3 In the single-image display, press <SET>.

4 Play back the movie.

- Select [▶] (Play movie), then press <SET>.
- ➔ The movie will start playing back.
- You can pause playback and display the movie playback panel by pressing <SET>.
- Volume during playback can be adjusted by pressing the <▲> <▼> keys.
- For more details on the playback operations, see page 297.

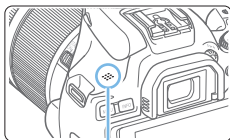
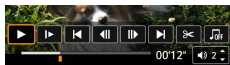













(1)

(1) Speaker















- The camera may not be able to play back movies shot with another camera.

Movie Playback Panel

Item	Playback Operations
 Play	Pressing <SET> toggles between playback and stop.
 Slow motion	Adjusts the slow motion speed by pressing the <◀> <▶> keys. The slow motion speed is indicated on the upper right of the screen.
 Skip backward	Skips backward approx. 4 sec. each time you press <SET>.
 Previous frame	Displays the previous frame each time you press <SET>. Holding <SET> down will rewind the movie.
 Next frame	Plays the movie frame-by-frame each time you press <SET>. Holding <SET> down will fast forward the movie.
 Skip forward	Skips forward approx. 4 sec. each time you press <SET>.
 Edit	Displays the editing screen (📖299).
 Frame Grab	Available when you play 4K or 4K time-lapse movies. Enables you to extract the current frame and save it as a JPEG still image (📖301).
 Background music	Plays back a movie with the selected background music (📖337).
	Playback position
mm' ss"	Playback time (minutes:seconds)
 Volume	Use the <▲> <▼> keys to adjust the speaker volume (📖296).
	Press the <MENU> button to return to the single-image display.

Movie Playback Panel (Video Snapshot Albums)

Item	Playback Operations
 Play	Pressing <SET> toggles between playback and stop.
 Slow motion	Adjust the slow motion speed by pressing the <◀> <▶> keys. The slow motion speed is indicated on the upper right of the screen.
 Previous clip	Displays the first frame of the previous video snapshot.
 Previous frame	Displays the previous frame each time you press <SET>. Holding <SET> down will rewind the movie.
 Next frame	Plays the movie frame-by-frame each time you press <SET>. Holding <SET> down will fast forward the movie.
 Next clip	Displays the first frame of the next video snapshot.
 Erase clip	Erases the current video snapshot.
 Edit	Displays the editing screen (📖299).
 Background music	Plays back a movie with the selected background music (📖337).
	Playback position
mm' ss"	Playback time (minutes:seconds)
 Volume	Use the <▲> <▼> keys to adjust the speaker volume (📖296).
 MENU ↩	Press the <MENU> button to return to the single-image display.



- Use television controls to adjust the volume when the camera is connected to a television for movie playback (📖305). (Volume cannot be adjusted by pressing the <▲> <▼> keys.)
- Movie playback may stop if the card's read speed is too slow or movie files have corrupted frames.

Playback with the Touch Screen

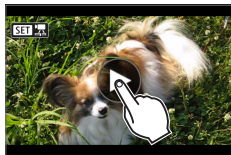

Tap [▶] at the center of the screen.

- The movie will start playing back.
- To display the Quick Control screen, tap <SET [⏏]> in the upper left.
- To pause the movie while it is playing back, tap on the screen. The movie playback panel will also appear.

Editing a Movie's First and Last Scenes

You can edit out the first and last scenes of a movie in approx. 1-sec. increments.

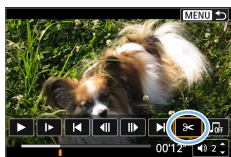

1 Pause movie playback.

- The movie playback panel will appear.

2 On the movie playback screen, select [X].

- The movie editing panel will be displayed at the bottom of the screen.



3 Specify the part to be edited out.

- Select either [Cut beginning] or [Cut end], then press <SET>.
- Press the <◀> <▶> keys to see the previous or next frames. Keep holding down the key to fast forward or fast rewind the frames.
- After deciding which part to edit out, press <SET>. The portion highlighted in white on the top is what will remain.



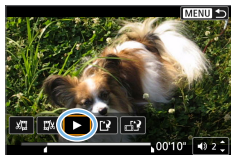

4 Check the edited movie.

- Select [▶] to play the edited movie.
- To change the edited part, go back to step 2.
- To cancel the editing, press the <MENU> button, then select [OK] on the confirmation dialog.

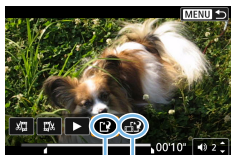

(1)(2)

5 Save the edited movie.

- Select [⏏] (1), then press <SET>.
- ➔ The save screen will appear.
- To save it as a new movie, select [New file]. To save it and overwrite the original movie file, select [Overwrite], then press <SET>.
- Select [⏏] (2) to save a compressed version of the file. 4K movies are converted to Full HD movies before compression.
- On the confirmation dialog, select [OK], then press <SET> to save the edited movie and return to the movie playback screen.



- Because editing is performed in approx. 1-sec. increments (at the position indicated by [✂] at the bottom of the screen), the actual position where movies are trimmed may differ from your specified position.
- If the card does not have enough free space, [New file] will not be available.
- When the battery level is low, movie editing is not possible. Use a fully-charged battery.
- Movies shot with another camera cannot be edited with this camera.

Grabbing a Frame from 4K Movies or 4K Time-Lapse Movies

From 4K movies or 4K time-lapse movies, you can select individual frames to save as approx. 8.3-megapixel (3840×2160) JPEG still images. This function is called “Frame Grab (4K frame capture)”.



1 Play back the image.

- Press the <▶> button.

2 Select a 4K movie or 4K time-lapse movie.

- Select with the <◀> <▶> keys.
- On the shooting information screen (📖 326), 4K movies and 4K time-lapse movies are indicated by an [4K] icon.
- In index display, press <SET> to switch to single-image display.

3 In the single-image display, press <SET>.

4 Pause movie playback.

- The movie playback panel will appear.

5 Select a frame to grab.

- Use the movie playback panel to select the frame to grab as a still photo.
- For movie playback panel instructions, see 📖 297.

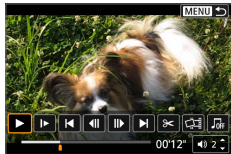

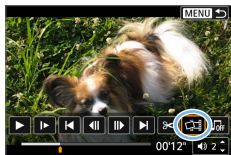

6 Select [Still].

- Select with the <◀> <▶> keys.

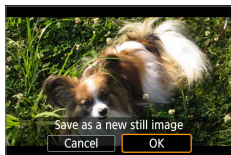

7 Save the image.

- Select [OK] to save the current frame as a JPEG still image.

8 Select the image to display.

- Check the destination folder and image file number.
- Select [View original movie] or [View extracted still image].



- Frame grabbing is not possible with Full HD movies, Full HD time-lapse movies, or with 4K movies or 4K time-lapse movies from a different camera.

Slide Show (Auto Playback)

You can automatically play back all the images on the card one after another.

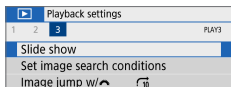

1 Select [Slide show].

- Under the [▶] tab, select [Slide show], then press <SET>.

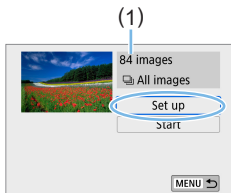

2 Configure [Set up] as desired.

- Press the <▲> <▼> keys to select [Set up], then press <SET>.
- Set the [Display time], [Repeat] (repeated playback), [Transition effect] (effect when changing images), and [Background music] for the still photos.
- See page 337 for the background music selection procedure.
- After completing the settings, press the <MENU> button.

(1) Number of images to be played back

[Display time]

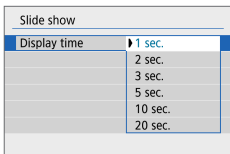

[Repeat]

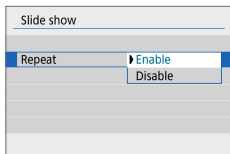

[Transition effect]

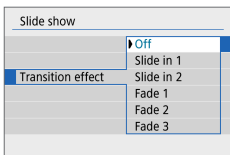

[Background music]

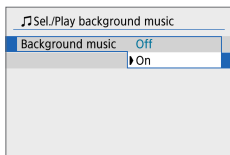

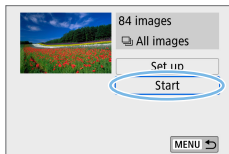

3 Start the slide show.

- Press the <▲> <▼> keys to select **[Start]**, then press <SET>.
- ➔ After **[Loading image...]** is displayed, the slide show will start.

4 Exit the slide show.

- To exit the slide show and return to the setting screen, press the <MENU> button.



- To pause the slide show, press <SET>. During pause, **[||]** will be displayed on the upper left of the image. Press <SET> again to resume the slide show. You can also pause the slide show by tapping on the screen.
- During auto playback, you can press the <INFO> button to switch the still photo display format (📖101).
- Volume during movie playback can be adjusted with the <▲> <▼> keys.
- During auto playback or pause, you can press the <◀> <▶> keys to view another image.
- During auto playback, auto power off will not take effect.
- The display time may differ depending on the image.
- To view the slide show on a TV set, see page 305.
- While viewing images in filtered playback with **[▶]: Set image search conditions**, you can play them back in a slide show.

Playback on a TV

By connecting the camera to a TV set with an HDMI cable, you can play back the captured still photos and movies on the TV set. For the HDMI cable, HDMI Cable HTC-100 (sold separately) is recommended.

If the image does not appear on the TV screen, check if the [**Video system**] is correctly set to [**For NTSC**] or [**For PAL**] (depending on the video system of your television).

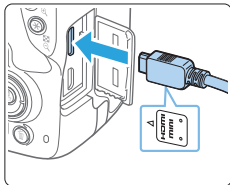

1 Connect the HDMI cable to the camera.

- With the plug's <▲HDMI MINI> logo facing the front of the camera, insert it into the <HDMI OUT> terminal.

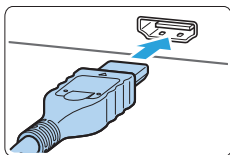

2 Connect the HDMI cable to the TV set.

- Connect the HDMI cable to the TV set's HDMI IN port.

3 Turn on the TV set and switch the TV set's video input to select the connected port.

4 Set the camera's power switch to <ON>.

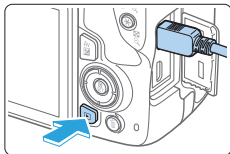

5 Press the <▶> button.

- ➔ The image will appear on the TV screen. (Nothing will be displayed on the camera's LCD monitor.)
- The images will automatically be displayed at the optimum resolution matching the connected TV set.
- By pressing the <INFO> button, you can change the display format.
- To play back movies, see page 296.



- Adjust movie sound volume with the TV set. The sound volume cannot be adjusted with the camera.
- Before connecting or disconnecting the cable between the camera and TV set, turn off the camera and TV set.
- Depending on the TV set, part of the image displayed may be cut off.
- Do not connect any other device's output to the camera's <HDMI OUT> terminal. Doing so may cause a malfunction.
- Certain TV sets may not display the images due to incompatibility.

Protecting Images

You can protect important images from being accidentally erased by the camera's erase function.

Protecting a Single Image

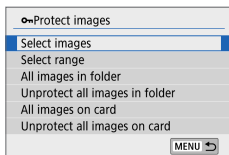
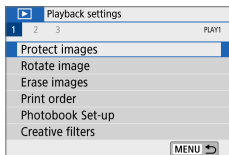

1 Select [Protect images].

- Under the [▶] tab, select [Protect images], then press <SET>.

2 Select [Select images].

- ➔ An image is displayed.

3 Select the image to be protected.

- Press the <◀> <▶> keys to select the image to be protected.

4 Protect the image.

- Press <SET> to protect the image. The <🔒> icon (1) will appear.
- To cancel the image protection, press <SET> again. The <🔒> icon will disappear.
- To protect another image, repeat steps 3 and 4.

Specifying the Range of Images to be Protected

You can specify the range of images to protect all the images in the range at once.

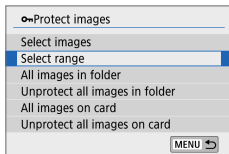

1 Select [Select range].

- Select [Select range] in []: **Protect images**], then press <SET>.

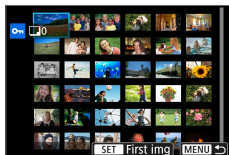

2 Specify the range of images.

- Select the first image (start point), then press <SET>.
- Select the last image (end point), then press <SET>.
- ➔ The images will be protected and the <> icon will appear.
- To cancel the selection, repeat this step.
- To return to the previous screen, press the <MENU> button.

Protecting All Images in a Folder or on a Card

You can protect all the images in a folder or on a card at once.

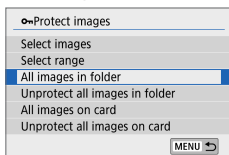

When you select **[All images in folder]** or **[All images on card]** in [**▶**]: **Protect images**, all the images in the folder or on the card will be protected.

To cancel the selection, select **[Unprotect all images in folder]** or **[Unprotect all images on card]**.



- If you format the card (📖 66), the protected images will also be erased.



- Movies can also be protected.
- Once an image is protected, it cannot be erased by the camera's erase function. To erase a protected image, you must first cancel the protection.
- If you erase all the images (📖 312), only the protected images will remain. This is convenient when you want to erase all unnecessary images at once.

Erasing Images

You can either select and erase unnecessary images one by one or erase them in one batch. Protected images (🔒 307) will not be erased.



- Once an image is erased, it cannot be recovered. Make sure you no longer need the image before erasing it. To prevent important images from being erased accidentally, protect them. Erasing an image shot in RAW+JPEG will erase both the RAW and JPEG images.

Erasing a Single Image

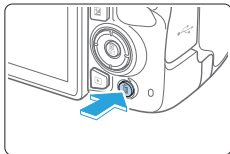

1 Play back the image to be erased.

2 Press the **<🗑>** button.

→ The Erase menu will appear.



3 Erase the image.

- Select **[Erase]**, then press **<SET>**. The image displayed will be erased.

Checkmarking **<✓>** Images to be Erased in a Batch

By adding checkmarks to the images to be erased, you can erase all those images at once.

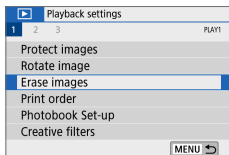

1 Select **[Erase images]**.

- Under the **[▶]** tab, select **[Erase images]**, then press **<SET>**.

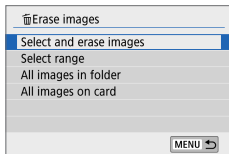

2 Select [Select and erase images].

→ An image is displayed.



3 Select the images to be erased.

- Press the <◀> <▶> keys to select the image to be erased, then press <SET>.
- A checkmark <✓> will be displayed on the upper left of the screen.
- By pressing the <☒·🔍> button, you can select images from a three-image display. To return to the single-image display, press the <🔍> button.
- To select another image to be erased, repeat step 3.

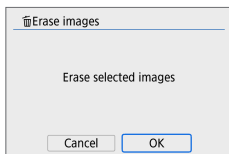

4 Erase the images.

- Press the <MENU> button.
- Select [OK], then press <SET>.
- The selected images will be erased.

Specifying the Range of Images to be Erased

You can specify the range of images to erase all the images in the range at once.

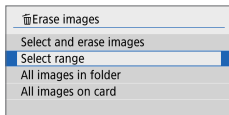

1 Select [Select range].

- Select [**Select range**] in [**▶**]: **Erase images**], then press <SET>.



2 Specify the range of images.

- Select the first image (start point), then press <SET>.
- Select the last image (end point), then press <SET>.
- ➔ The [**✓**] icon will appear on the selected images.
- To cancel the selection, repeat this step.
- To return to the previous screen, press the <MENU> button.

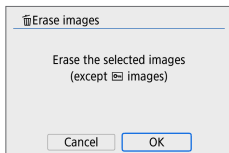

3 Erase the images.

- Press the <MENU> button.
- Select [**OK**] on the confirmation dialog, then press <SET>.
- ➔ The selected images will be erased.

Erasing All Images in a Folder or on a Card

You can erase all the images in a folder or on a card at once. When [**▶**]: **Erase images**] is set to [**All images in folder**] or [**All images on card**], all the images in the folder or on the card will be erased.



- To erase all images including protected images, format the card (66).

Preparing to Print

The direct printing procedure can be performed entirely with the camera while looking at the setting screens on camera's LCD monitor.

Connecting the Camera to a Printer

1 Set up the printer.

- For details, refer to the printer's instruction manual.

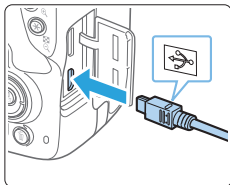

2 Connect the camera to the printer.

- Connect them with an interface cable (sold separately).
- Connect the cable to the camera's digital terminal with the cable plug's icon facing the front of the camera.
- To connect to the printer, refer to the printer's instruction manual.

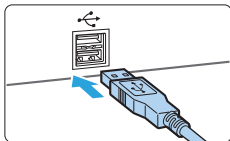

3 Turn on the printer.

4 Set the camera's power switch to <ON>.

- Some printers may make a beeping sound.
- The image will appear with an icon on the upper left of the screen to indicate that the camera is connected to a printer.



- Before using the printer, make sure it has a PictBridge connection port.
- Movies cannot be printed.
- The camera cannot be used with printers compatible only with CP Direct or Bubble Jet Direct.
- If there is a long beeping sound in step 4, it indicates a problem with the printer. Resolve the problem displayed in the error message (📖390).



- You can also print RAW images taken with this camera.
- When you use a battery to power the camera, make sure it is fully charged.
- Before disconnecting the cable, first turn off the camera and printer. Hold the plug (not the cord) to pull out the cable.
- For direct printing, using DC Coupler DR-E18 (sold separately) and AC Adapter AC-E6N (sold separately) to power the camera is recommended.

Printing

The screen display and setting options vary depending on the printer. Also, certain settings may not be available. For details, refer to the printer's instruction manual.



(1)

1 Select the image to be printed.

- Check that the icon is displayed on the upper left of the LCD monitor.
- Press the <◀> <▶> keys to select the image to be printed.

(1) Printer-connected icon

2 Press <SET>.

- ➔ The print setting screen will appear.
- For setting details, see “Print Settings” (📖 386).

Digital Print Order Format (DPOF)

DPOF (Digital Print Order Format) enables you to print images recorded on the card according to your printing instructions such as the image selection, quantity to print, etc. You can print multiple images in one batch or create a print order for a photofinisher.

You can set the print settings such as print type, date imprinting, file number imprinting, etc. The print settings will be applied to all the images specified for printing. (They cannot be set individually for each image.)

Setting the Printing Options

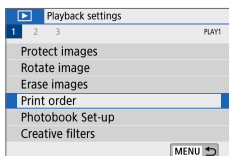

1 Select [Print order].

- Under the [▶] tab, select [Print order], then press <SET>.

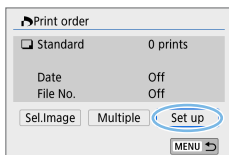

2 Select [Set up].

3 Set the options as desired.

- Set the [Print type], [Date], and [File No.].
- Select the desired item, then press <SET>. Select the desired setting, then press <SET>.

[Print type]

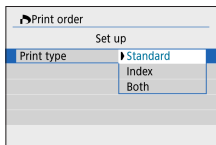

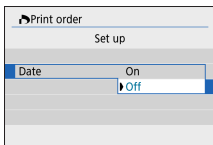

[Date]

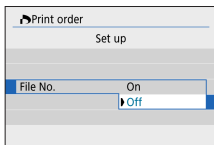

[File No.]



Print type		Standard	Prints one image on one sheet.
		Index	Multiple thumbnail images are printed on one sheet.
		Both	Prints both the standard and index prints.
Date	On	[On] imprints the recorded date of the captured image.	
	Off		
File number	On	[On] imprints the file number.	
	Off		

4 Exit the setting.

- Press the <MENU> button.
- ➔ The print order screen will reappear.
- Next, select **[Sel.Image]** or **[Multiple]** to order the images to be printed.



- RAW images or movies cannot be specified for printing.
- Even if **[Date]** and **[File No.]** are set to **[On]**, the date or file number may not be imprinted depending on the print type setting and printer model.
- With **[Index]** prints, the **[Date]** and **[File No.]** cannot both be set to **[On]** at the same time.
- When printing with DPOF, use the card for which print order specifications are set. You cannot print in the specified print order if you extract just the images from the card for printing.
- Certain DPOF-compliant printers and photofinishers may not be able to print the images as you specified. Refer to the printer's instruction manual before printing, or check with your photofinisher about compatibility when ordering prints.
- While installing images into this camera, do not specify a new print order for images that had a print order set by a different camera. All the print orders may be overwritten inadvertently. Also, the print order may not be possible, depending on the image type.

Specifying Images for Printing

Selecting Images

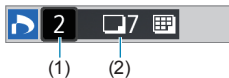
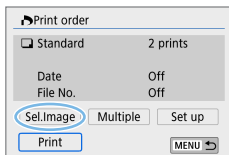

Select and specify the images one by one. By pressing the $\langle \text{Sel. Image} \rangle$ button, you can select images from a three-image display. To return to the single-image display, press the $\langle \text{Sel. Image} \rangle$ button. Press the $\langle \text{MENU} \rangle$ button to save the print order to the card.

- **[Standard] [Both]**

Press the $\langle \blacktriangle \rangle$ $\langle \blacktriangledown \rangle$ keys to set the number of copies to be printed for the displayed image.

- (1) Quantity
- (2) Total images selected

- **[Index]**

Press $\langle \text{SET} \rangle$ to add a checkmark to the box $\langle \checkmark \rangle$. The image will be included in the index print.

- (3) Checkmark
- (4) Index icon

Selecting Multiple Images

- **Select Range**

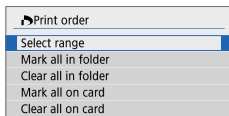

1 Select [Select range].

- Select **[Select range]** in **[Multiple]**, then press <SET>.

2 Specify the range of images.

- Select the first image (start point), then press <SET>.
- Select the last image (end point), then press <SET>.
- ➔ The **[✓]** icon will appear on the selected images.
One copy of all the specified images will be set for printing.
- To cancel the selection, repeat this step.
- To return to the previous screen, press the <MENU> button.

- **All Images in a Folder**

Select **[Mark all in folder]** and select the folder. A print order for one copy of all the images in the folder will be specified. If you select **[Clear all in folder]** and select the folder, the print order for all the images in the folder will be canceled.

- **All Images on a Card**

If you select **[Mark all on card]**, one copy of all the images on the card will be specified for printing. If you select **[Clear all on card]**, the print order will be cleared for all the images on the card.



- Note that RAW images or movies will not be specified for printing even if you specify all images at once with **[Multiple]**.
- When using a PictBridge-compatible printer, do not specify more than 400 images for one print order. If you specify more than this, the images may not all be printed.

Specifying Images for a Photobook

You can specify up to 998 images to be printed in a photobook. When you use EOS Utility (EOS software) to transfer images to a computer, the specified images for the photobook will be copied to a dedicated folder. This function is useful for ordering photobooks online.

Specifying One Image at a Time

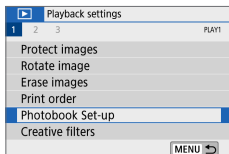

1 Select [Photobook Set-up].

- Under the [▶] tab, select [Photobook Set-up], then press <SET>.

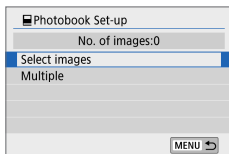

2 Select [Select images].

- An image is displayed.



3 Select the image to be specified.

- Press the <<◀> <▶> keys to select the image to be specified, then press <SET>.
- Repeat this step to select another image. The number of images that have been specified will be displayed on the upper left of the screen.
- To display the three-image display, press the <☒-Q> button. To return to the single-image display, press the <Q> button.
- To cancel the image specification, press <SET> again.

Specifying the Range

You can specify the range of images to select all the images in the range at once for the photobook.

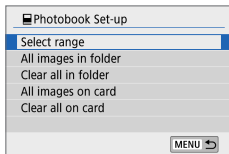

1 Select [Select range].

- In [Multiple] under [▶]: Photobook Set-up], select [Select range], then press <SET>.



2 Specify the range of images.

- Select the first image (start point), then press <SET>.
- Select the last image (end point), then press <SET>.
- ➔ The [✓] icon will appear on the selected images.
- To cancel the selection, repeat this step.
- To return to the previous screen, press the <MENU> button.

Specifying All Images in a Folder or on a Card

You can also specify all the images in a folder or on a card at once for the photobook.

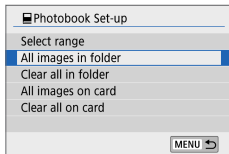

When **[Multiple]** under **[▶]: Photobook Set-up** is set to **[All images in folder]** or **[All images on card]**, all the images in the folder or on the card will be specified for the photobook.

To clear your selections, select **[Clear all in folder]** or **[Clear all on card]**.



- RAW images or movies cannot be specified.
- Do not specify images already specified for a photobook in another camera for another photobook with this camera. All the photobook settings may be overwritten inadvertently.

Shooting Information Display

The information displayed varies depending on the shooting mode and settings.

Still Photo Example

● Basic information display

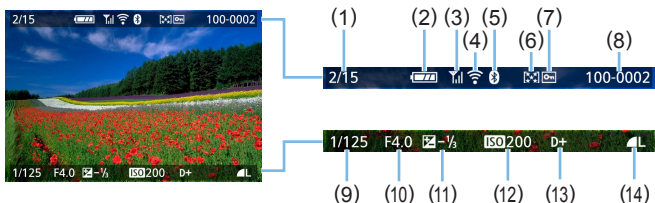

- | | |
|--|----------------------------------|
| (1) Playback No./Total images recorded | (8) Folder number - File number |
| (2) Battery level | (9) Shutter speed |
| (3) Wi-Fi signal strength | (10) Aperture |
| (4) Wi-Fi function | (11) Exposure compensation level |
| (5) Bluetooth function | (12) ISO speed |
| (6) Rating | (13) Highlight tone priority |
| (7) Image protection | (14) Image-recording quality |

● AF Point Display

When [**▶**]: **AF point disp.**] is set to [**Enable**], the AF point that achieved focus will be displayed in red. If automatic AF point selection is set, multiple AF points may be displayed at the same time.



- If the image was taken by another camera, certain shooting information may not be displayed.
- It may not be possible to play back images taken with this camera on other cameras.

● Shooting information display
- Detailed information

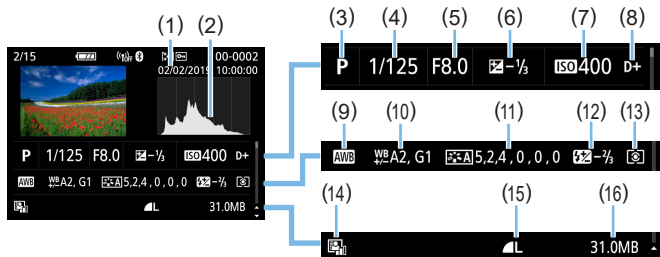

- | | |
|---------------------------------|--|
| (1) Shooting date/time | (10) White balance correction |
| (2) Histogram (Brightness/RGB) | (11) Picture Style setting details |
| (3) Shooting mode | (12) Flash exposure compensation amount/Multi Shot Noise Reduction |
| (4) Shutter speed | (13) Metering mode |
| (5) Aperture | (14) Auto Lighting Optimizer |
| (6) Exposure compensation level | (15) Image-recording quality |
| (7) ISO speed | (16) File size |
| (8) Highlight tone priority | |
| (9) White balance | |

* When you shoot in the RAW+JPEG image-recording quality, the RAW file size will be displayed.

* During flash photography without flash exposure compensation, <⚡> will be displayed.

* <NR> will be displayed for images shot with Multi Shot Noise Reduction.

* <✓> will be displayed for images shot with a Creative filter, or images edited (by resizing them or applying a Creative filter or Creative Assist) and then saved.

* <✓> and <✂> will be displayed for images cropped and then saved.

- Lens/Histogram information

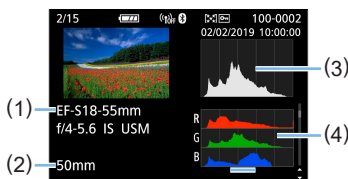

- (1) Lens name
- (2) Focal length
- (3) Histogram display (Brightness)
- (4) Histogram display (RGB)

- White balance information

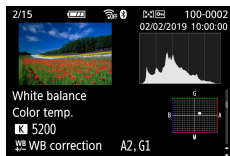

- Picture Style information 1

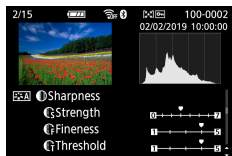

- Picture Style information 2

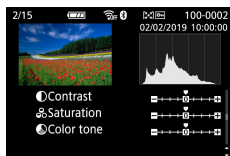

- Color space/Noise reduction information

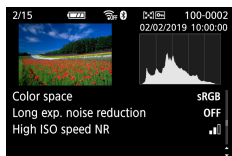

- Lens aberration correction information

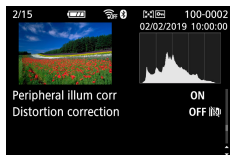

- Record of sent images

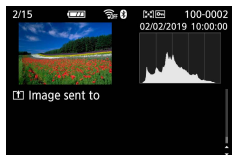

- If you used GPS Receiver GP-E2 or smartphone to record GPS information for the image, the "GPS information" screen will also appear.

Movie Example

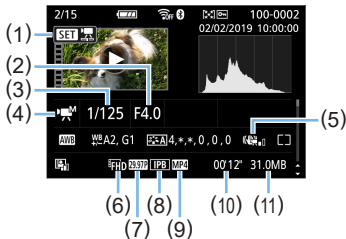

- | | |
|--|-----------------------------------|
| (1) Playback | (6) Movie recording size |
| (2) Aperture | (7) Frame rate |
| (3) Shutter speed | (8) Compression method |
| (4) Movie shooting mode / Time-lapse movie | (9) Movie recording format |
| (5) Movie digital IS | (10) Shooting time, Playback time |
| | (11) Movie file size |

* If manual exposure is used, the shutter speed, aperture, and ISO speed (when set manually) will be displayed.

* The  icon will be displayed for video snapshots.



- During movie playback, “*,” “*” will be displayed for **[Fineness]** and **[Threshold]** of **[Picture Style]**'s **[Sharpness]**.

- **Highlight Alert**

When the shooting information is displayed, overexposed and clipped highlights will blink. To obtain a better result for the blinking areas where you want the gradation to be faithfully reproduced, set the exposure compensation to a negative amount and shoot again.

- **Histogram**

The brightness histogram shows the exposure level distribution and overall brightness. The RGB histogram is for checking the color saturation and gradation. The display can be switched with [**▶**]: **Histogram disp.**

[Brightness] Display

This histogram is a graph showing the distribution of the image's brightness level. The horizontal axis indicates the brightness level (darker on the left and brighter on the right), while the vertical axis indicates how many pixels exist for each brightness level. The more pixels there are toward the left, the darker the image. The more pixels there are toward the right, the brighter the image. If there are too many pixels on the left, the shadow detail will be lost. If there are too many pixels on the right, the highlight detail will be lost. The gradation in-between will be reproduced. By checking the image and its brightness histogram, you can see the exposure level inclination and the overall gradation.

Sample Histograms



Dark image



Normal brightness



Bright image

[RGB] Display

This histogram is a graph showing the distribution of each primary color's brightness level in the image (RGB or red, green, and blue). The horizontal axis indicates the color's brightness level (darker on the left and brighter on the right), while the vertical axis indicates how many pixels exist for each color brightness level. The more pixels there are toward the left, the darker and less prominent the color. The more pixels there are toward the right, the brighter and denser the color. If there are too many pixels on the left, the respective color information will be lacking. If there are too many pixels on the right, the color will be too saturated with no gradation. By checking the image's RGB histogram, you can see the color's saturation and gradation condition, as well as white balance inclination.

Post-Processing Images

After taking a picture, you can apply a filter effect, resize the JPEG image (reduce the pixel count), or crop the JPEG image.



- The camera may not be able to process images taken with another camera.
- Post-processing of images as described in this chapter cannot be performed when the camera is connected to a computer with an interface cable.

Applying Creative Filter Effects

You can apply the following Creative filters to an image and save it as a new image: Grainy B/W, Soft focus, Fish-eye effect, Art bold effect, Water painting effect, Toy camera effect, and Miniature effect.

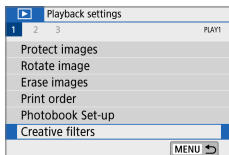

1 Select [Creative filters].

- Under the [▶] tab, select [Creative filters], then press <SET>.
- ➔ An image will be displayed.



2 Select an image.

- Select the image you want to apply a filter to.
- By pressing the [◀▶] button, you can switch to the index display and select an image.



3 Select a filter effect.

- When you press <SET>, the types of Creative filters will be displayed (book 330).
- Select a filter, then press <SET>.
- ➔ The image will be displayed with the effects of the filter applied.



4 Adjust the filter effect.

- Adjust the filter effect, then press <SET>.
- For the Miniature effect, press the <▲> <▼> keys to move the white frame to where you want the image to look sharp, then press <SET>.

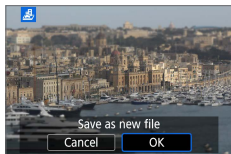

5 Save the image.

- Select **[OK]** to save the image.
- Check the destination folder and image file number, then select **[OK]**.
- To apply a filter to another image, repeat steps 2 to 5.



- When shooting RAW+JPEG image, the Creative filter will be applied to the RAW image and the image will be saved as a JPEG image.
- If an aspect ratio was set for a RAW image and the filter effect is applied to it, the image will be saved in the aspect ratio that is set.
- Dust Delete Data (📖274) will not be appended to images with Fish-eye effect applied.

Creative Filter Characteristics

● 📷 Grainy B/W

Creates a grainy black-and-white photo. You can change the black-and-white effect by adjusting the contrast.

● 👤 Soft focus

Gives the image a soft look. You can change the degree of softness by adjusting the blur.





● 🐟 Fish-eye effect

Gives the effect of a fish-eye lens. The image will have a barrel-type distortion.

Depending on the level of this filter effect, the area trimmed along the periphery of the image changes. Also, since this filter effect will magnify the image center, the apparent resolution at the center may degrade depending on the number of recorded pixels. Set the filter effect in step 4 while checking the resulting image.

● 🎨 Art bold effect

Makes the photo look like an oil painting and the subject look more three-dimensional. You can adjust the contrast and saturation. Note that subjects such as the sky or white walls may not be rendered with a smooth gradation and may look irregular or have significant noise.

-  **Water painting effect**
Makes the photo look like a watercolor painting with soft colors. You can control the color density by adjusting the filter effect. Note that night scenes or dark scenes may not be rendered with a smooth gradation and may look irregular or have significant noise.
-  **Toy camera effect**
Darkens the photo's corners and applies a unique color tone that makes it look as if it was shot by a toy camera. You can change the color cast by adjusting the color tone.
-  **Miniature effect**
Creates a diorama effect. You can change where the image looks sharp. In step 4, if you press the <INFO> button (or tap on  on the screen), you can switch between the white frame's vertical and horizontal orientations.

Applying Your Favorite Effects (Creative Assist)

You can process RAW images by applying your preferred effects and saving as JPEGs.

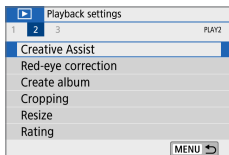

1 Select [Creative Assist].

- Under the [▶] tab, select [Creative Assist], then press <SET>.



2 Select an image.

- Use the <◀> <▶> keys to select images to process, then press <SET>.



3 Select an effect level.

- Use the <◀> <▶> keys to select the effect.



- By selecting [Preset] and pressing <SET>, you can choose [VIVID], [SOFT], or other preset effects. [AUTO1], [AUTO2], and [AUTO3] are effects recommended by the camera based on image conditions.



- You can select effects such as **[Brightness]** or **[Contrast]** by pressing <SET> and then using the <◀> <▶> keys.
- Press <SET> when adjustment is finished.
- To reset the effect, press the <✳> button.
- To confirm the effect, press the <☑> button.

4 Select [OK] to save the image.

Red-eye Correction

Automatically corrects images affected by red-eye. You can save the corrected image as a separate file.

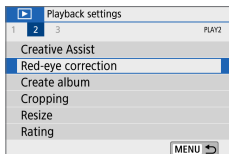

1 Choose [Red-eye correction].

- Under the [▶] tab, select [Red-eye correction], then press <SET>.

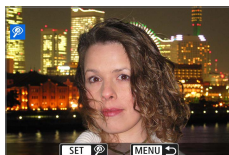

2 Select an image.

- Press the <◀> <▶> keys to select the image.

3 Correct the image.

- Either touch [🔍] or press <SET>.
- ➔ Frames are displayed around corrected image areas.

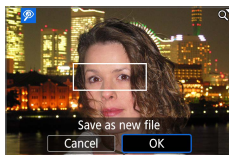

4 Select [OK].

- The image is now saved as a new file.

! • Some images may not be corrected accurately.

Editing Video Snapshot Albums

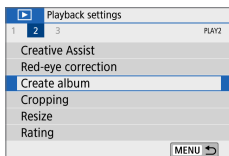

1 Select [Create album].

- Under the [▶] tab, select [Create album], then press <SET>.

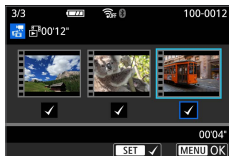

2 Select an album to edit.

- Press <SET> to add a checkmark [✓].
- After selection, press the <MENU> button.

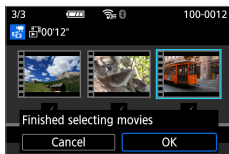

3 Select [OK].



4 Select an editing option.

- Press the <◀> <▶> keys to select an editing option, then press <SET>.

Option	Description
↔ Rearrange video snapshots	Press the <◀> <▶> keys to select the video snapshot you want to move, then press <SET>. Press the <◀> <▶> keys to move the snapshot, then press <SET>.
🗑 Remove video snapshot	Press the <◀> <▶> keys to select the video snapshot you want to delete, then press <SET>. The [🗑] icon will be displayed on the selected video snapshot. Pressing <SET> again will cancel the selection and [🗑] will disappear.
▶ Play video snapshot	Press the <◀> <▶> keys to select the video snapshot you want to play back, then press <SET>. Use the <▲> <▼> keys to adjust the volume.

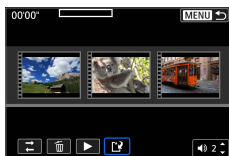

5 Finish editing.

- Press the <MENU> button when you are finished editing.
- Select [🔒] (Finish editing), then press <SET>.

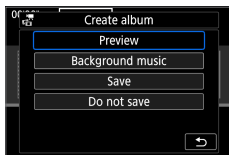

6 Save the image.

- To play an album with background music, use [**Background music**] to select the music (📖 337).
- To check your editing, select [**Preview**].
- Selecting [**Save**] saves the edited album as a new album.



- Video snapshot albums can only be edited once.

Selecting the Background Music

Albums and slideshows can be played with background music once you copy the music to the card, using EOS Utility (EOS software).

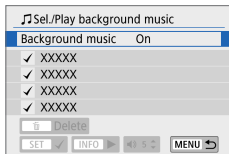

- 1 Select [Background music].**
 - Set **[Background music]** to **[On]**.

- 2 Select the background music.**
 - Use the <▲> <▼> keys to select the music, then press <SET>. For **[Slide show]**, you can select multiple tracks.

- 3 Play the background music.**
 - To listen to a sample of the background music, press the <INFO> button.
 - Use the <▲> <▼> keys to adjust the volume. To stop listening to the background music, press the <INFO> button again.
 - To delete the music, use the <▲> <▼> keys to select it, then press the <🗑️> button.



- For the procedure to copy background music to a card, refer to the EOS Utility Instruction Manual.

Resizing JPEG Images

You can resize a JPEG image to make the pixel count lower and save it as a new image. Resizing an image is possible only with JPEG L, M, and S1 images. **JPEG S2 and RAW images cannot be resized.**

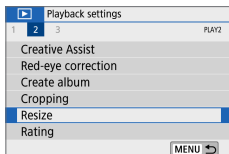

1 Select [Resize].

- Under the [▶] tab, select [Resize], then press <SET>.
- ➔ An image will be displayed.



2 Select an image.

- Select the image you want to resize.
- By pressing the <⏏> button, you can switch to the index display and select an image.



(1)

3 Select the desired image size.

- Press <SET> to display the image sizes.
- Select the desired image size (1), then press <SET>.

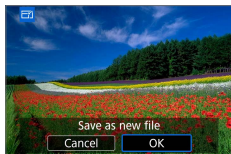

4 Save the image.

- Select [OK] to save the resized image.
- Check the destination folder and image file number, then select [OK].
- To resize another image, repeat steps 2 to 4.

Resize Options by Original Image Quality

Original Image Quality	Available Resize Settings		
	M	S1	S2
L	<input type="radio"/>	<input type="radio"/>	<input type="radio"/>
M		<input type="radio"/>	<input type="radio"/>
S1			<input type="radio"/>



- Images may be slightly cropped, depending on the combination of resizing and aspect ratio.

Cropping JPEG Images

You can crop a captured JPEG image and save it as another image. Cropping an image is possible only with JPEG images. **Images shot in RAW cannot be cropped.**

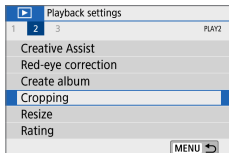

1 Select [Cropping].

- Under the [▶] tab, select [Cropping], then press <SET>.
- ➔ An image will be displayed.



2 Select an image.

- Select the image you want to crop.
- By pressing the <[Crop Icon]> button, you can switch to the index display and select an image.





3 Set the cropping frame size, aspect ratio, position, and tilt correction.

- Press <SET> to display the cropping frame.
- ➔ The image area within the cropping frame will be cropped.

Changing the Cropping Frame Size

- Press the <[Crop Icon]> or <[Crop Icon]> button.
- ➔ The cropping frame size will change. The smaller the cropping frame, the more magnified the cropped image will look.



Changing the Cropping Frame Aspect Ratio

- Turn the <  > dial to select .
- ➔ Each press of <SET> changes the cropping frame aspect ratio.
- ➔ This also enables you to crop the image shot in horizontal orientation to look as if it was shot in vertical orientation.



Moving the Cropping Frame

- Press the <▲> <▼> or <◀> <▶> keys.
- ➔ The cropping frame will move up, down, left, or right.
- You can also touch the cropping frame and drag it to the desired position.

Correcting the Tilt



- Turn the <  > dial to select .
- ➔ Check the tilt with the displayed grid, then turn the <  > dial to correct the tilt.

You can correct the tilt up to $\pm 10^\circ$ in 0.1° increments.

- ➔ If you tap on  or  on the upper left of the screen, the tilt will be corrected in 0.5° increments.
- Press <SET>.



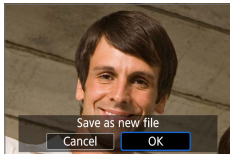

4 Display the cropped image in the full view.

- Turn the <  > dial to select .
- ➔ You can see the cropped image.
- To return to the original display, press the <SET> button again.



5 Save the image.

- Turn the <  > dial to select .
- Press <SET>, then select **[OK]** to save the cropped image.
- Check the destination folder and image file number, then select **[OK]**.
- To crop another image, repeat steps 2 to 5.



- The position and size of the cropping frame may change depending on the angle set for tilt correction.
- Once a cropped image is saved, it cannot be cropped again. In addition, you cannot resize it or apply a Creative filter.
- AF point display information (📖323) and Dust Delete Data (📖274) will not be appended to the cropped images.

Specifying Initial Image Display When Playback Begins

You can specify which image is displayed first when you start image playback.

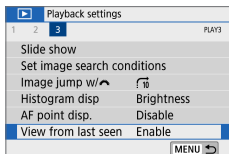

1 Select [View from last seen].

- Under the [**▶**] tab, select [**View from last seen**], then press <SET>.

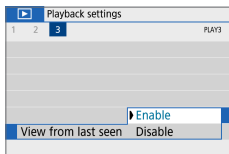

2 Select an item.

- Press the <▲> <▼> keys to select an option.

- **[Enable]:** Playback resumes from the last image displayed (except when you have just finished shooting).
- **[Disable]:** Playback resumes from your most recent shot whenever the camera is restarted.

Wireless Features

This chapter describes how to connect the camera to a smartphone wirelessly via Bluetooth® or Wi-Fi® and send images to devices or Web services, as well as how to control the camera from a computer or wireless remote control.

What You Can Do via Wireless Communication Functions

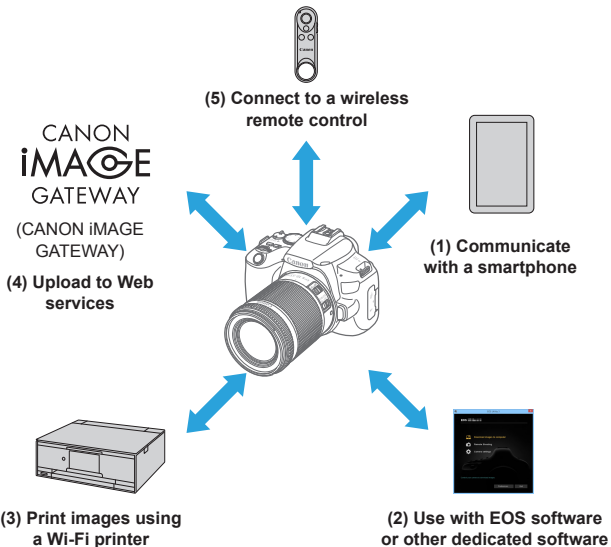

Important

Note that Canon cannot be held liable for any loss or damage from erroneous wireless communication settings when using the camera. In addition, Canon cannot be held liable for any other loss or damage caused by use of the camera.

When using wireless communication functions, establish appropriate security at your own risk and discretion. Canon cannot be held liable for any loss or damage caused by unauthorized access or other security breaches.

Tab Menus: Wireless Tab

((P)) Wireless settings	
1	NETWORK
Wi-Fi/Bluetooth connection	347
Wi-Fi settings Enable	416
Bluetooth settings Enable	417
Nickname XXXXX	418
GPS device settings	419
Clear wireless settings	425

MENU ↩



- Wireless communication is not available while the camera is connected via an interface cable to a computer or other device.
- Other devices, such as computers, cannot be used with the camera by connecting them with an interface cable while the camera is connected to devices via Wi-Fi.
- The camera cannot be connected via Wi-Fi if there is no card in the camera (except for [L]). Also, for [B] and Web services, the camera cannot be connected via Wi-Fi if there are no images saved on the card.
- The Wi-Fi connection will be terminated if you set the camera's power to <OFF>, or open the card slot/battery compartment cover.
- With a Wi-Fi connection established, the camera's auto power off does not function.

Selection of Wi-Fi/Bluetooth Connection

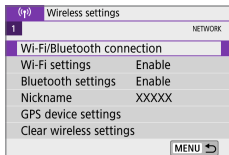

1 Select [Wi-Fi/Bluetooth connection].

- Under the [(P)] tab, select [Wi-Fi/Bluetooth connection], then press <SET>.



2 Select an item for the camera to connect to.

(1) Communicate with a smartphone (📖349)

Control the camera remotely and browse images on the camera over a Wi-Fi connection by using the dedicated Camera Connect app on smartphones or tablets (collectively referred to as “smartphones” in this manual).

(2) Use with EOS software or other dedicated software (📖374)

Connect the camera to a computer via Wi-Fi and operate the camera remotely using EOS Utility (EOS software). With the dedicated application Image Transfer Utility 2, images on the camera can also be sent to a computer automatically.

(3) Print images using a Wi-Fi printer (📖381)

Connect the camera to a printer supporting PictBridge (Wireless LAN) via Wi-Fi to print images.

(4)  Send images to a Web service  391

Share images with friends or family on social media or the CANON iMAGE GATEWAY online photo service for Canon customers after you complete member registration (free of charge).

(5)  Connect to a wireless remote control

This camera can also be connected to Wireless Remote Control BR-E1 (sold separately) via Bluetooth for remote control shooting  410).

Connecting to a Smartphone

You can do the following after pairing the camera with a smartphone compatible with Bluetooth low energy technology (hereafter, “Bluetooth”).

- Establish a Wi-Fi connection using only the smartphone (📖351).
- Establish a Wi-Fi connection with the camera even when it is off (📖356).
- Geotag images with GPS information acquired by the smartphone (📖420).
- Control the camera remotely from a smartphone (📖355).

You can also do the following after connecting the camera to a smartphone via Wi-Fi.

- Browse and save images on the camera from a smartphone (📖355).
- Control the camera remotely from a smartphone (📖355).
- Send images to a smartphone from the camera (📖363).

Turning on Bluetooth and Wi-Fi on a Smartphone

Turn on Bluetooth and Wi-Fi from the smartphone settings screen. Note that pairing with the camera is not possible from the smartphone’s Bluetooth settings screen.



- To establish a Wi-Fi connection via an access point, see “Wi-Fi Connection via Access Points” (📖405).

Installing Camera Connect on a Smartphone

The dedicated app Camera Connect (free of charge) must be installed on the smartphone on which Android or iOS is installed.

- Use the latest version of the smartphone OS.
- Camera Connect can be installed from Google Play or App Store. Google Play or App Store can also be accessed using the QR codes that appear when the camera is paired or connected via Wi-Fi to a smartphone.



- For the operating system versions supported by Camera Connect, refer to the download site of Camera Connect.
- Sample screens and other details in this guide may not match the actual user interface elements after camera firmware updates or updates to Camera Connect, Android, or iOS.

Connecting to a Bluetooth-compatible Smartphone via Wi-Fi

Steps on the Camera (1)

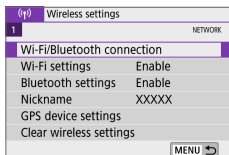

1 Select [Wi-Fi/Bluetooth connection].

- Under the [(Wi-Fi)] tab, select [**Wi-Fi/Bluetooth connection**], then press <SET>.



2 Select [☑ Connect to smartphone].

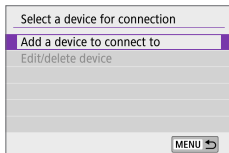

3 Select [Add a device to connect to].

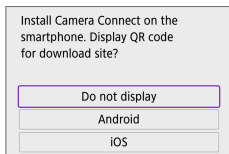

4 Select an item.

- If Camera Connect is already installed, select [**Do not display**].
- If Camera Connect is not installed, select [**Android**] or [**iOS**], scan the displayed QR code with the smartphone to access Google Play or App Store and install Camera Connect.



5 Select [Pair via Bluetooth].

- Press <SET> to start pairing.

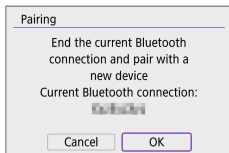

- To pair with a different smartphone after pairing with one initially, select [OK] on the screen at left, then press <SET>.

Steps on the Smartphone (1)



6 Start Camera Connect.

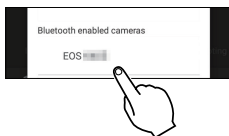

7 Touch the camera for pairing.

- ➔ If you are using an Android smartphone, go to step 9.

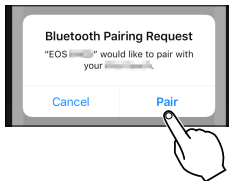

8 Tap on [Pair] (iOS only).

Steps on the Camera (2)

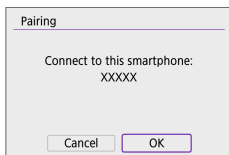

9 Select [OK], then press <SET>.

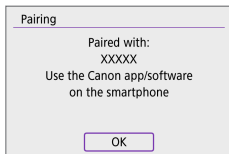

10 Press <SET>.

- Pairing is now complete, and the camera is connected to the smartphone via Bluetooth.

A Bluetooth icon appears on the main Camera Connect screen.

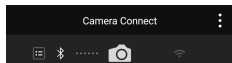

- The camera cannot be connected to two or more devices at the same time via Bluetooth. To switch to a different smartphone for the Bluetooth connection, see [423](#).
- Bluetooth connection consumes battery power even after the camera's auto power off is activated. Therefore, the battery level may be low when you use the camera.

Troubleshooting Pairing

- Keeping pairing records for previously paired cameras on your smartphone will prevent it from pairing with this camera. Before you try pairing again, remove pairing records for previously paired cameras from your smartphone's Bluetooth settings screen.



- With a Bluetooth connection established, you can operate the camera to send images to the smartphone ([363](#)).

Steps on the Smartphone (2)

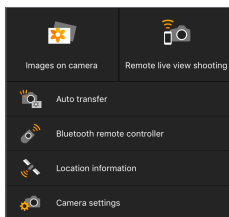

11 Select and tap on a Camera Connect function.

- In iOS, tap **[Join]** when a message is displayed to confirm camera connection.
- For the Camera Connect functions, see 355.
- When a Wi-Fi connection is established, the screen for the selected function will appear.
- **Wi-Fi on** is displayed on the camera's LCD monitor.
- The Bluetooth and Wi-Fi icons are lit on the main Camera Connect screen.

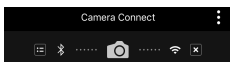
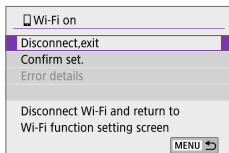

The Wi-Fi connection to a Bluetooth-compatible smartphone is now complete.

- For how to terminate the Wi-Fi connection, see “Terminating Wi-Fi Connections” (370).
- Terminating the Wi-Fi connection will switch the camera to the Bluetooth connection.
- To reconnect via Wi-Fi, start Camera Connect and tap the function you will use.

Wi-Fi on Screen

Disconnect,exit

- Terminates the Wi-Fi connection.

Confirm set.

- You can check the settings.

Error details

- When a Wi-Fi connection error occurs, you can check the details of the error.

Camera Connect Functions

Images on camera

- Images can be browsed, deleted, or rated.
- Images can be saved on a smartphone.

Remote live view shooting

- Enables remote shooting as you view a live image on the smartphone.

Auto transfer

- Enables camera and app setting adjustment to send shots to a smartphone automatically as they are captured (📖362).

Bluetooth remote controller

- Enables remote control of the camera from a smartphone paired via Bluetooth. (Not available when connected via Wi-Fi.)
- Before using a Bluetooth remote control, consider setting a longer auto power off time.

Location information

- Not supported on this camera.

Camera settings

- Camera settings can be changed.

Establishing a Wi-Fi Connection When the Camera Is Off

Even with the camera power switch set to <OFF>, as long as the camera is paired with a smartphone via Bluetooth, you can use the smartphone to connect via Wi-Fi.

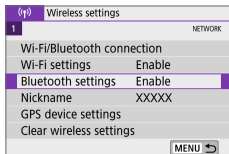

1 Select [Bluetooth settings].

- Under the [(P)] tab, select [Bluetooth settings], then press <SET>.

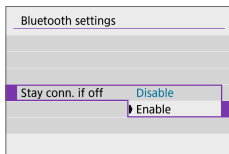

2 Set [Stay conn. if off] to [Enable].

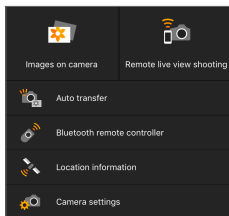

- With the camera power switch set to <OFF>, tap [Images on camera] in the Camera Connect menu to start the Wi-Fi connection.
- In iOS, tap [Join] when a message is displayed to confirm camera connection. Images on the camera are listed when the Wi-Fi connection is established.

- You can use Camera Connect to save images to the smartphone or delete images on the camera.
- To terminate the Wi-Fi connection, tap on [X] on the main Camera Connect screen (370).



- This function can no longer be used if the wireless settings are reset or the smartphone connection information is erased.

Canceling the Pairing

Cancel pairing with a smartphone as follows.

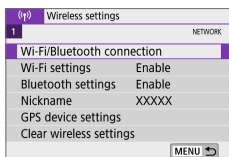

1 Select [Wi-Fi/Bluetooth connection].

- Under the [(P)] tab, select [Wi-Fi/Bluetooth connection], then press <SET>.



2 Select [Connect to smartphone].

- If the history (413) is displayed, switch the screen with the <◀> <▶> keys.

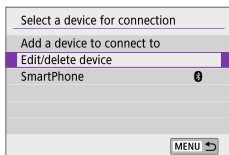

3 Select [Edit/delete device].

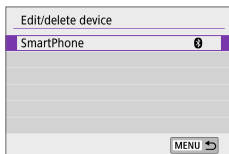

4 Select the smartphone to cancel pairing with.

- Smartphones currently paired with the camera are labeled [8].

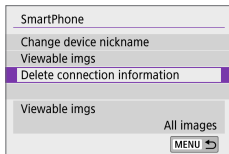

5 Select [Delete connection information].

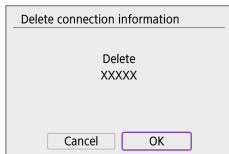

6 Select [OK], then press <SET>.

7 Clear the camera information on the smartphone.

- In the smartphone's Bluetooth setting menu, clear the camera information registered on the smartphone.

Wi-Fi Connection Without Using Bluetooth

Steps on the Camera (1)

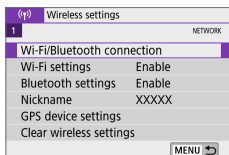

1 Select [Wi-Fi/Bluetooth connection].

- Under the [(1)] tab, select [Wi-Fi/Bluetooth connection], then press <SET>.

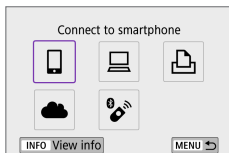

2 Select [Connect to smartphone].

- If the history (413) is displayed, switch the screen with the <<> <>> keys.

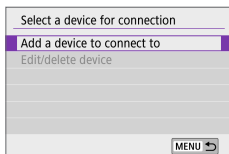

3 Select [Add a device to connect to].

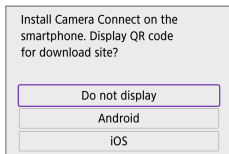

4 Select an item.

- If Camera Connect is already installed, select [Do not display].

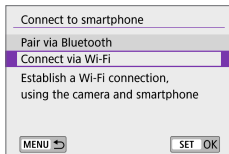

5 Select [Connect via Wi-Fi].

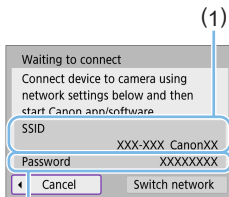

6 Check the SSID (network name) and password.

- Check the SSID (1) and password (2) displayed on the camera's LCD monitor.
- In [(?): Wi-Fi settings], if you set [Password] to [None], the password will not be displayed or required (416).



- By selecting [Switch network] in step 6, you can establish a Wi-Fi connection via an access point (405).

Steps on the Smartphone

Smartphone's screen (sample)



7 Operate the smartphone to establish a Wi-Fi connection.

- Activate the smartphone's Wi-Fi function, then tap the SSID (network name) checked in step 6.
- For the password, enter the password checked in step 6.

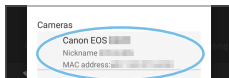

8 Start Camera Connect and tap the camera to connect to via Wi-Fi.

Steps on the Camera (2)

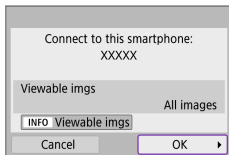

9 Select [OK].

- To specify viewable images, press the <INFO> button. See step 5 on [371](#) to set them.

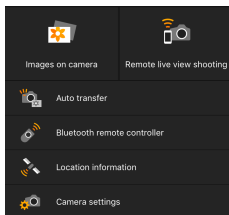

- The main window of Camera Connect will be displayed on the smartphone.

The Wi-Fi connection to a smartphone is now complete.

- Operate the camera using Camera Connect ([355](#)).

- For how to terminate the Wi-Fi connection, see “Terminating Wi-Fi Connections” ([370](#)).
- To reconnect via Wi-Fi, see “Reconnecting via Wi-Fi” ([413](#)).



- When connected via Wi-Fi, you can send images to a smartphone from the Quick Control screen during playback ([363](#)).

Automatic Image Transfer as You Shoot

Your shots can be automatically sent to a smartphone. Before following these steps, make sure the camera and smartphone are connected via Wi-Fi.

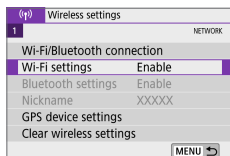

1 Select [Wi-Fi settings].

- Under the [(Wi-Fi)] tab, select [Wi-Fi settings], then press <SET>.

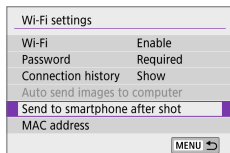

2 Select [Send to smartphone after shot].

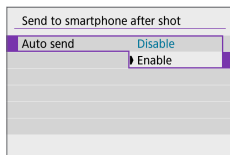

3 In [Auto send], select [Enable].

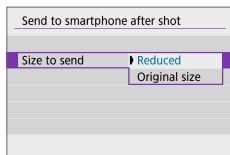

4 Set [Size to send].

5 Take the picture.

Sending Images to a Smartphone from the Camera

You can use the camera to send images to a smartphone paired via Bluetooth (Android devices only) or connected via Wi-Fi.

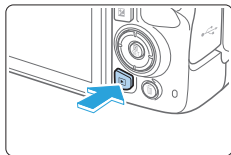

1 Play back the image.

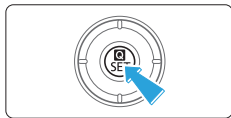

2 Press the **<Q>** button.



3 Select **[]**.

- If you perform this step while connected via Bluetooth, a message is displayed, and the connection switches to a Wi-Fi connection.

4 Select sending options and send the images.

(1) Sending Images Individually



1 Select an image to send.

- Use the <◀> <▶> keys to select an image to send, then press <SET>.
- By pressing the <☒-Q> button, you can switch to the index display and select an image.

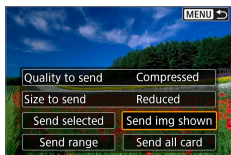

2 Select [Send img shown].

- In [Size to send], you can select the image sending size.
- When sending movies, you can select the image quality of movies to send in [Quality to send].

(2) Sending Multiple Selected Images



1 Press <SET>.

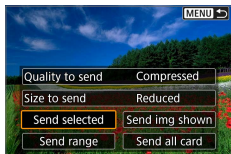

2 Select [Send selected].

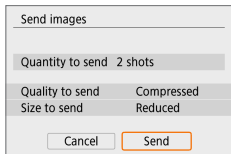
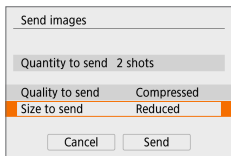
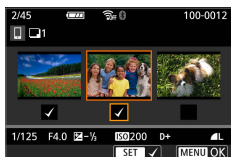

3 Select images to send.

- Use the <◀> <▶> keys to select images to send, then press <SET>.

- You can press the <☒·🔍> button to select the images from 3-image display. To return to the single-image display, press <🔍>.
- After selecting the images to send, press the <MENU> button.

4 Exit image selection.

- Select [OK].

5 Select [Size to send].

- On the displayed screen, select an image size.

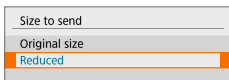

- When sending movies, select the image quality in [Quality to send].

6 Select [Send].

(3) Sending a Specified Range of Images



1 Press <SET>.

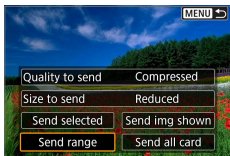

2 Select [Send range].



3 Specify the range of images.

- Select the first image (start point).
- Select the last image (end point).
- To cancel the selection, repeat this step.
- You can press the <[Grid/Zoom In]> button to change the number of images shown in the index display.

4 Confirm the range.

- Press the <MENU> button, then press [OK].

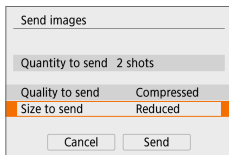

5 Select [Size to send].

- On the displayed screen, select an image size.

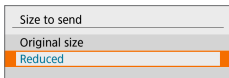

- When sending movies, select the image quality in [Quality to send].

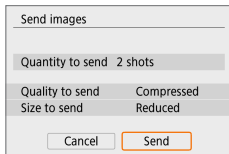

6 Select [Send].

(4) Sending All Images on the Card



1 Press <SET>.

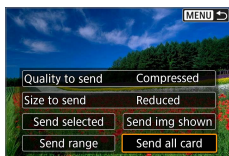

2 Select [Send all card].

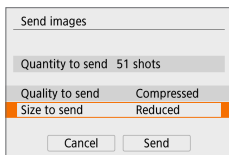

3 Select [Size to send].

- On the displayed screen, select an image size.

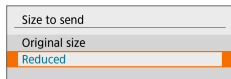

- When sending movies, select the image quality in [Quality to send].

4 Select [Send].

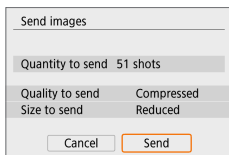

(5) Sending Images that Match the Search Conditions

Send all the images that match the search conditions set in **[Set image search conditions]** at once.

For **[Set image search conditions]**, refer to “Filtering Images for Playback” (291).



1 Press <SET>.

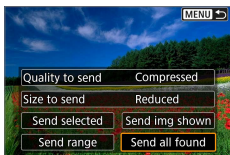

2 Select **[Send all found]**.

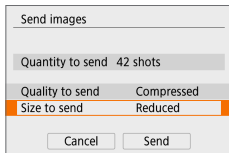

3 Select **[Size to send]**.

- On the displayed screen, select an image size.

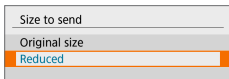

- When sending movies, select the image quality in **[Quality to send]**.

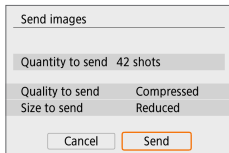

4 Select **[Send]**.

Ending Image Transfer

Sending Images from the Camera When Paired via Bluetooth (Android)



- Press the <MENU> button on the image transfer screen.



- Select [OK] on the screen on the left to end image transfer and the Wi-Fi connection.

Sending Images from the Camera over a Wi-Fi Connection



- Press the <MENU> button on the image transfer screen.
- To terminate the Wi-Fi connection, see "Terminating Wi-Fi Connections" (📖370).



- During the image transfer operation, a picture cannot be taken even if the camera's shutter button is pressed.



- With a Wi-Fi connection established, disabling the smartphone's power saving function is recommended.
- Selecting the reduced size for still photos applies to all still photos sent at that time. Note that **S2** size still photos are not reduced.
- Selecting compression for movies applies to all movies sent at that time.
- When you use a battery to power the camera, make sure it is fully charged.

Terminating Wi-Fi Connections

Perform either of the following operations.

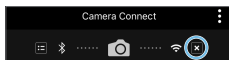

On the **Camera Connect** screen, tap on **[X]**.

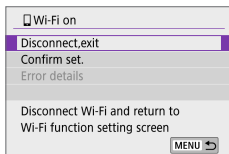

On the **[Wi-Fi on]** screen, select **[Disconnect,exit]**.

- If **[Wi-Fi on]** is not displayed, select **[Wi-Fi/Bluetooth connection]** under the **[(P)]** tab.
- Select **[Disconnect,exit]**, then select **[OK]** on the confirmation dialog.

Settings to Make Images Viewable from Smartphones

Images can be specified after the Wi-Fi connection is terminated.

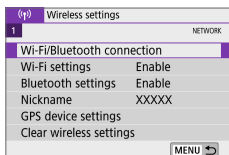

1 Select **[Wi-Fi/Bluetooth connection]**.

- Under the **[(P)]** tab, select **[Wi-Fi/Bluetooth connection]**, then press **<SET>**.



2 Select **[Connect to smartphone]**.

- If the history (**413**) is displayed, switch the screen with the **<<>** **>>>** keys.

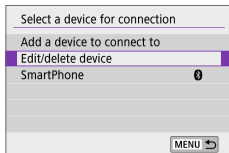

3 Select **[Edit/delete device]**.

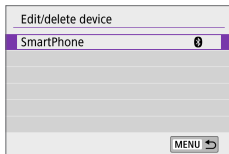

4 Select a smartphone.

- Select the name of the smartphone on which you want to make the images viewable.

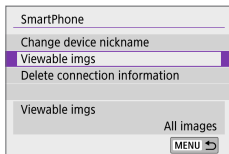

5 Select [Viewable imgs].

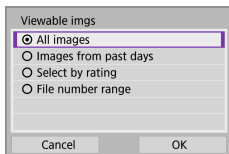

6 Select an item.

- Select **[OK]** to access the setting screen.

[All images]

All images stored on the card become viewable.

[Images from past days]

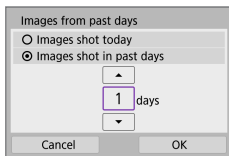

Specify viewable images on the shooting-date basis. Images shot up to nine days ago can be specified.

- When **[Images shot in past days]** is selected, images shot up to the specified number of days before the current date become viewable. Use the <▲> <▼> keys to specify the number of days, then press <SET> to confirm the selection.
- Once you select **[OK]**, the viewable images are set.



- If **[Viewable imgs]** is set to any setting other than **[All images]**, remote shooting is not possible.

[Select by rating]

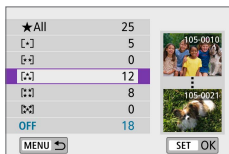

Specify viewable images depending on whether a rating is appended (or not appended) or by the type of rating.

- Once you select the type of rating, the viewable images are set.

[File number range] (Select range)

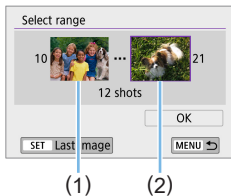

Select the first and last images from images arranged by the file number to specify the viewable images.

1. Press <SET> to display the image selection screen.

Press the <◀> <▶> keys to select the image.

By pressing the <☒> button, you can switch to the index display and select an image.

2. Select an image as the starting point (1).
3. Use <▶> to select an image as the ending point (2).
4. Select **[OK]**.



- If the Wi-Fi connection is terminated while recording a movie with remote shooting, the following will occur.
 - If the power switch is set to <'M'>, movie shooting will continue.
 - If the power switch is set to <ON>, movie shooting will stop.
- When the power switch is set to <ON> and the camera is set to the movie shooting mode using Camera Connect, you cannot operate the camera to shoot.
- With a Wi-Fi connection to a smartphone established, certain functions are unavailable.
- In remote shooting, the AF speed may become slower.
- Depending on the communication status, image display or shutter release timing may be delayed.
- When saving images to a smartphone, you cannot take a picture even if you press the camera's shutter button. Also, the camera's LCD monitor may turn off.



- With a Wi-Fi connection established, disabling the smartphone's power saving function is recommended.

Connecting to a Computer via Wi-Fi

This section describes how to connect the camera to a computer via Wi-Fi and perform camera operations using EOS software or other dedicated software. Install the latest version of software on the computer before setting up a Wi-Fi connection.

For computer operating instructions, refer to the computer user manual.

Operating the Camera Using EOS Utility

Using EOS Utility (EOS software), you can import images from the camera, control the camera, and perform other operations.

Steps on the Camera (1)

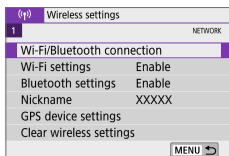

1 Select [Wi-Fi/Bluetooth connection].

- Under the [(P)] tab, select [Wi-Fi/Bluetooth connection], then press <SET>.

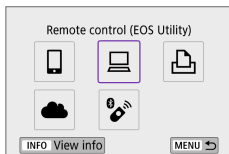

2 Select [Remote control (EOS Utility)].

- If the history (413) is displayed, switch the screen with the <◀> <▶> keys.

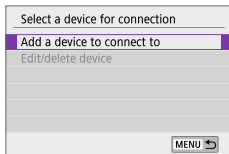

3 Select [Add a device to connect to].

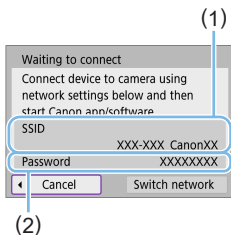

4 Check the SSID (network name) and password.

- Check the SSID (1) and password (2) displayed on the camera's LCD monitor.
- In [(?) : Wi-Fi settings], if you set [Password] to [None], the password will not be displayed or required. For details, see 416.

Steps on the Computer (1)

Computer's screen (sample)

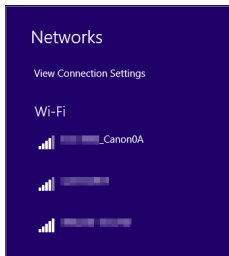

5 Select the SSID, then enter the password.

- On the computer's network setting screen, select the SSID checked in step 4.
- For the password, enter the password checked in step 4.

Steps on the Camera (2)

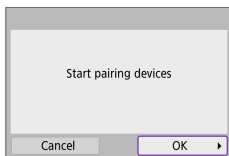

6 Select [OK].

- The following message is displayed. "*****" represents the last six digits of the MAC address of the camera to be connected.

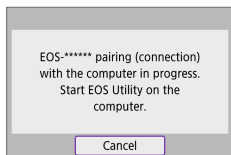

Steps on the Computer (2)



7 Start EOS Utility.

8 In EOS Utility, click [Pairing over Wi-Fi/LAN].

- If a firewall-related message is displayed, select [Yes].

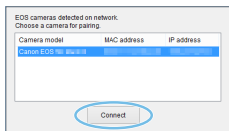

9 Click [Connect].

- Select the camera to connect to, then click [Connect].

Steps on the Camera (3)

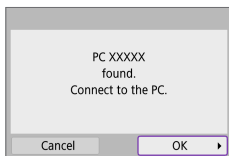

10 Establish a Wi-Fi connection.

- Select [OK].

[Wi-Fi on] Screen

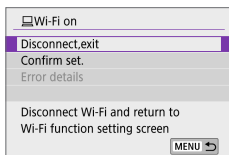

Disconnect,exit

- Terminates the Wi-Fi connection.

Confirm set.

- You can check the settings.

Error details

- When a Wi-Fi connection error occurs, you can check the details of the error.

The Wi-Fi connection to a computer is now complete.

- Operate the camera using EOS Utility on the computer.
- To reconnect via Wi-Fi, see “Reconnecting via Wi-Fi” (413).



- If the Wi-Fi connection is terminated while recording a movie with remote shooting, the following will occur.
 - If the power switch is set to <P>, movie shooting will continue.
 - If the power switch is set to <ON>, movie shooting will stop.
- Operations using the camera are not possible after you use EOS Utility to switch from still photo shooting mode to movie recording mode.
- With a Wi-Fi connection to EOS Utility established, certain functions are unavailable.
- In remote shooting, the AF speed may become slower.
- Depending on the communication status, image display or shutter release timing may be delayed.
- In Remote Live View shooting, the rate of image transmission is slower compared to a connection via an interface cable. Therefore, moving subjects cannot be displayed smoothly.

Sending Images on the Camera Automatically

With the dedicated software Image Transfer Utility 2, you can send images on the camera to a computer automatically.

Steps on the Computer (1)

1 Connect the computer and access point and start Image Transfer Utility 2.

- The screen to set up pairing is shown when you follow the instructions displayed the first time Image Transfer Utility 2 starts up.

Steps on the Camera (1)

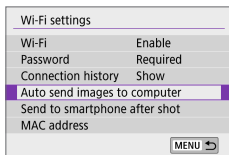

2 Select [Auto send images to computer].

- Under the [(P)] tab, select [Wi-Fi settings], then press <SET>.
- Select [Auto send images to computer].

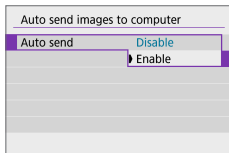

3 In [Auto send], select [Enable].

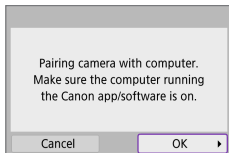

4 Select [OK].

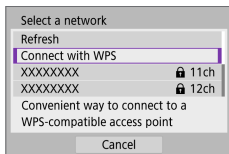

5 Connect to an access point via Wi-Fi.

- Establish a Wi-Fi connection between the camera and the access point connected to the computer. For connection instructions, see “Wi-Fi Connection via Access Points” (📖405).

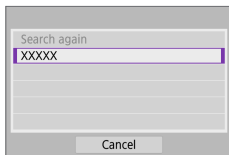

6 Select the computer to pair the camera with.

Steps on the Computer (2)

7 Pair the camera and computer.

- Select the camera, then click [Pairing].

Steps on the Camera (2)

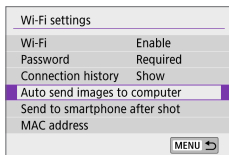

8 Select [Auto send images to computer].

- Under the [(i)] tab, select [Wi-Fi settings], then press <SET >.
- Select [Auto send images to computer].

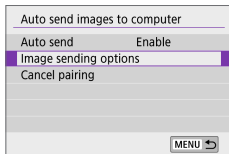

9 Select [Image sending options].

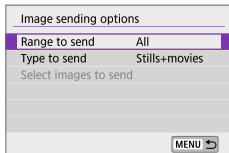

10 Select what to send.

- If you select [Selected imgs] in [Range to send], specify the images to send on the [Select images to send] screen.
- After the settings are complete, turn the camera off.

Images on the camera are automatically sent to the active computer when you turn the camera on within range of the access point.



- If images are not sent automatically, try restarting the camera.

Connecting to a Printer via Wi-Fi

This section describes how to print images by directly connecting the camera to a printer supporting PictBridge (Wireless LAN) via Wi-Fi. For printer operating instructions, refer to the printer user manual.

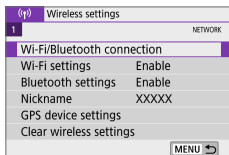

1 Select [Wi-Fi/Bluetooth connection].

- Under the [(P)] tab, select [Wi-Fi/Bluetooth connection], then press <SET>.

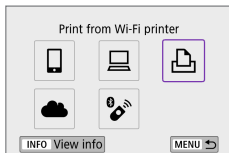

2 Select [Print from Wi-Fi printer].

- If the history (413) is displayed, switch the screen with the <◀> <▶> keys.

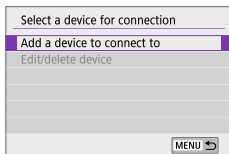

3 Select [Add a device to connect to].

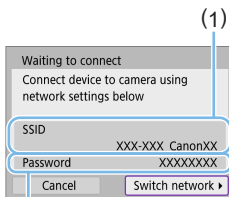

4 Check the SSID (network name) and password.

- Check the SSID (1) and password (2) displayed on the camera's LCD monitor.
- In [(P): Wi-Fi settings], if you set [Password] to [None], the password will not be displayed or required (416).

5 Set up the printer.

- On the Wi-Fi settings menu of the printer to be used, select the SSID you have checked.
- For the password, enter the password checked in step 4.

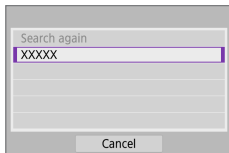

6 Select the printer.

- In the list of detected printers, select the printer to connect to via Wi-Fi.
- If your preferred printer is not listed, selecting [**Search again**] may enable the camera to find and display it.



- To establish a Wi-Fi connection via an access point, see “Wi-Fi Connection via Access Points” (📖405).

Image Printing

Printing Images Individually



1 Select the image to be printed.

- Use the <◀> <▶> keys to select an image to print, then press <SET>.
- By pressing the <☒-Q> button, you can switch to the index display and select an image.

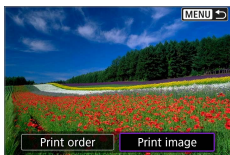

2 Select [Print image].

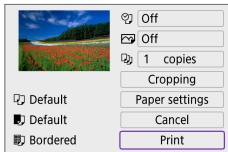

3 Print the image.

- For the print setting procedures, see [386](#).
- Select [**Print**], then [**OK**] to start printing.

Printing According to Specified Image Options



1 Press <SET>.



2 Select [Print order].

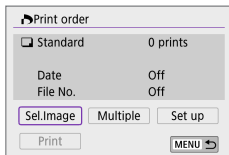

3 Set the print options.

- For the print setting procedures, refer to “Digital Print Order Format (DPOF)” (📖316).
- If the print order is complete before establishing a Wi-Fi connection, go to step 4.

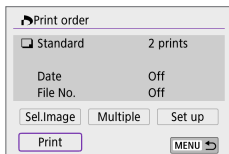

4 Select [Print].

- [Print] can be selected only when an image is selected and the printer is ready to print.

5 Set the [Paper settings] (📖386).

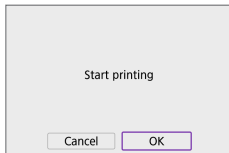

6 Print the image.

- When [OK] is selected, printing starts.



- Shooting is not possible while connected to a printer via Wi-Fi.
- Movies cannot be printed.
- Before printing, be sure to set the paper size.
- Certain printers may not be able to imprint the file number.
- If **[Bordered]** is set, certain printers may imprint the date on the border.
- Depending on the printer, the date may appear faint if it is imprinted on a bright background or on the border.
- RAW images cannot be printed by selecting **[Print order]**. When printing, select **[Print image]** and print.



- When you use a battery to power the camera, make sure it is fully charged.
- Depending on the image's file size and image quality, it may take some time to start printing after you select **[Print]**.
- To stop printing, press <SET> while **[Stop]** is displayed, then select **[OK]**.
- When printing with **[Print order]**, if you stopped printing and want to resume printing of the remaining images, select **[Resume]**. Note that printing will not resume if any of the following occurs.
 - You change the print order or delete any of the print ordered images before resuming printing.
 - When index is set, you change the paper setting before resuming printing.
- If a problem occurs during printing, see 390.

Print Settings

The screen display and setting options vary depending on the printer. Also, certain settings may not be available. For details, refer to the printer's instruction manual.

Print setting screen

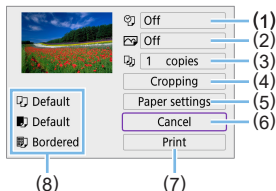

- (1) Sets date or file number printing (📖 388).
- (2) Sets the printing effects (📖 388).
- (3) Sets the number of copies to print (📖 388).
- (4) Sets the print area (📖 389).
- (5) Sets the paper size, type, and layout (📖 387).
- (6) Returns to the image selection screen.
- (7) Starts the printing.
- (8) The paper size, type, and layout you have set are displayed.

* Depending on the printer, certain settings may not be selectable.

Paper Settings

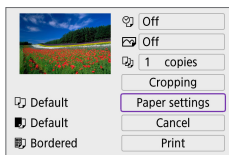

- Select **[Paper settings]**.

[🖨️] Setting the Paper Size

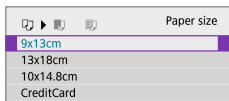

- Select the size of the paper in the printer.

[🖨️] Setting the Paper Type

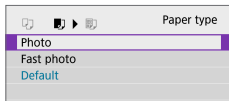

- Select the type of the paper in the printer.

[🖨️] Setting the Page Layout

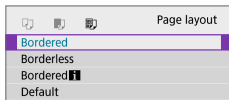



- Select the page layout.

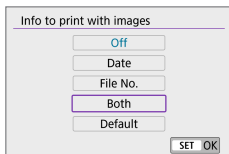

- If the image's aspect ratio is different from the printing paper's aspect ratio, the image may be cropped significantly when you print it as a borderless print. Images may also be printed at lower resolution.

Setting the Date/File Number Imprinting



- Select [].
- Select what to print.

Setting the Printing Effects (Image Optimization)

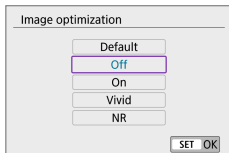

- Select [].
- Select printing effects.



- If you imprint shooting information on an image shot at an expanded ISO speed (H), the correct ISO speed may not be imprinted.
- The **[Default]** setting for printing effects and other options are the printer's own default settings as set by the printer's manufacturer. Refer to the printer's instruction manual to find out what the **[Default]** settings are.

Setting the Number of Copies



- Select [].
- Select the number of copies to print.

Cropping the Image

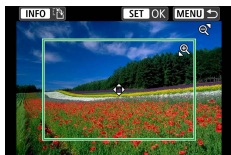

Set cropping immediately before printing. Changing other print settings after you crop images may require you to crop the images again.

- 1 On the print setting screen, select [Cropping].**
- 2 Set the cropping frame size, position, and aspect ratio.**
 - The image area within the cropping frame will be printed. The shape of the frame (aspect ratio) can be changed with **[Paper settings]**.

Changing the Cropping Frame Size

Use the <Q> <Q> buttons to resize the cropping frame.

Moving the Cropping Frame

Press the <⬆> <⬇> <⬇> <⬆> cross keys to move the frame vertically or horizontally.

Switching the Orientation of the Cropping Frame

Pressing the <INFO> button will toggle the cropping frame between the vertical and horizontal orientations.

- 3 Press <SET> to exit the cropping.**
 - You can check the cropped image area on the upper left of the print setting screen.



- Depending on the printer, the cropped image area may not be printed as you specified.
- The smaller the cropping frame, the lower the resolution at which images are printed.



Handling Printer Errors

- If printing does not resume after you resolve a printer error (no ink, no paper, etc.) and select **[Continue]**, operate the buttons on the printer. For details on resuming printing, refer to the printer's instruction manual.

Error Messages

- If a problem occurs during printing, an error message will appear on the camera's LCD monitor. After fixing the problem, resume printing. For details on how to fix a printing problem, refer to the printer's instruction manual.

Paper Error

- Confirm that paper is loaded correctly.

Ink Error

- Check the printer's ink level and the waste ink tank.

Hardware Error

- Check for any printer problems other than paper and ink problems.

File Error

- The selected image cannot be printed. Images taken with a different camera or images edited with a computer may not be printable.

Sending Images to a Web Service

This section describes how to use Web services to send images.

Registering Web Services

Use a smartphone or computer to add your Web services to the camera.

- A smartphone or computer with a browser and Internet connection is required to complete camera settings for CANON iIMAGE GATEWAY and other Web services.
- Visit the CANON iIMAGE GATEWAY website for details on versions of browsers (such as Microsoft Internet Explorer) and settings required for CANON iIMAGE GATEWAY access.
- For information on countries and regions where CANON iIMAGE GATEWAY is available, visit the Canon website (<http://www.canon.com/cig/>).
- For CANON iIMAGE GATEWAY instructions and setting details, refer to the help information for CANON iIMAGE GATEWAY.
- If you also intend to use Web services other than CANON iIMAGE GATEWAY, you must have an account with the services you intend to use. For further details, check the websites for each Web service you will register.
- Fees to connect to your provider and communication fees to access your provider's access point are charged separately.

Registering CANON iMAGE GATEWAY

Link the camera and CANON iMAGE GATEWAY by adding CANON iMAGE GATEWAY as a destination Web service on the camera.

You will need to enter an email address used on your computer or smartphone.

Steps on the Camera (1)

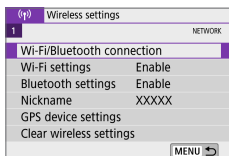

1 Select [Wi-Fi/Bluetooth connection].

- Under the [(Wi-Fi)] tab, select [Wi-Fi/Bluetooth connection], then press <SET>.

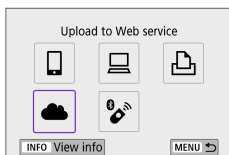

2 Select [Upload to Web service].

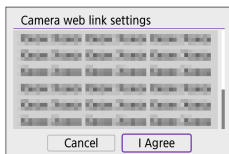

3 Select [I Agree].

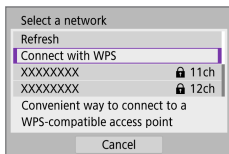

4 Establish a Wi-fi connection.

- Connect to an access point via Wi-Fi. Go to step 7 on 406.

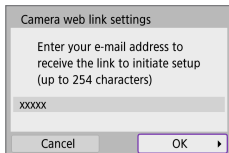

5 Enter your email address.

- Enter your email address, then select [OK].

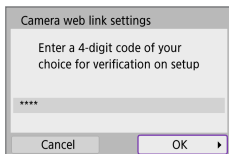

6 Enter a four-digit number.

- Enter a four-digit number of your choice, then select [OK].

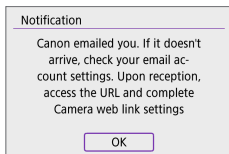

7 Select [OK].

- The [🌩️] icon changes to [🔒].

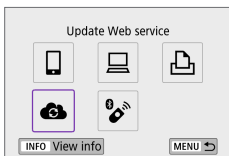

Steps on the Computer or Smartphone

8 Set up camera web link.

- Access the page in the notification message.
- Follow the instructions to complete the settings on the camera web link settings page.

Steps on the Camera (2)

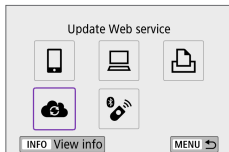

9 Add CANON iMAGE GATEWAY as a destination.

- Select [📶].
CANON iMAGE GATEWAY is now added.



Registering Other Web Services

Steps on the Computer or Smartphone

1 Configure the Web service you want to use.

- Visit the CANON IMAGE GATEWAY website and access the camera web link settings page.
- Follow the on-screen instructions to complete settings for Web services you want to use.

Steps on the Camera

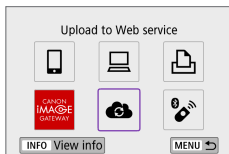

2 Add the Web service you configured as a destination.

- Under the [(P)] tab, select [Wi-Fi/Bluetooth connection], then press <SET>.
- Select [☁].

Sending Images

You can share images with your family and friends by sending images from the camera to a Web service registered on the camera or by sending Web links of the online albums.

Connecting to Web Services via Wi-Fi

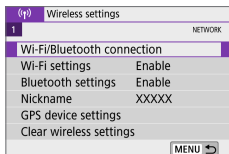

1 Select [Wi-Fi/Bluetooth connection].

- Under the [(📶)] tab, select [**Wi-Fi/Bluetooth connection**], then press <SET>.



2 Select a Web service.

- If the history (📖413) is displayed, switch the screen with the <◀> <▶> keys.
- A screen to select a destination may be displayed, depending on the type and settings of the Web service (📖408).

Sending Images Individually



1 Select an image to send.

- Use the <◀> <▶> keys to select an image to send, then press <SET>.
- By pressing the <☒-Q> button, you can switch to the index display and select an image.

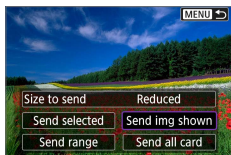

2 Select [Send img shown].

- In **[Size to send]**, you can select the image sending size.
- On the screen after images are sent, select **[OK]** to end the Wi-Fi connection.
- When the **[Terms of use]** screen is displayed, thoroughly read the message, then select **[I Agree]**.
- To scroll the screen, use the <▲> <▼> keys.

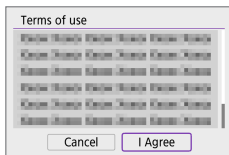

Sending Multiple Selected Images



1 Press <SET>.

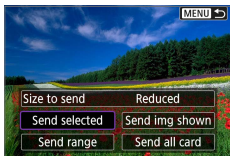

2 Select [Send selected].



3 Select images to send.

- Use the <◀> <▶> keys to select an image to send, then press <SET>.
- By pressing the <☒·🔍> button, you can select images from a three-image display. To return to the single-image display, press the <🔍> button.
- After selecting the images to send, press the <MENU> button.

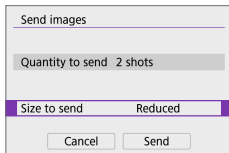

4 Select [Size to send].

- When YouTube is selected as the destination, **[Size to send]** is not displayed.
- On the displayed screen, select an image size.

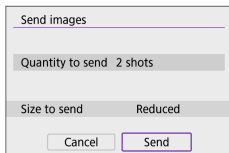
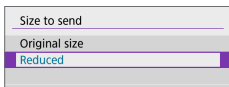

5 Select [Send].

- On the screen after images are sent, select **[OK]** to end the Wi-Fi connection.

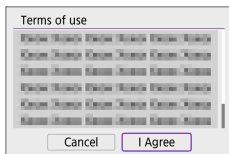

- When the **[Terms of use]** screen is displayed, thoroughly read the message, then select **[I Agree]**.
- To scroll the screen, use the <▲> <▼> keys.

Sending a Specified Range of Images

Specify the range of images to send all the images in the range at once.



1 Press <SET>.

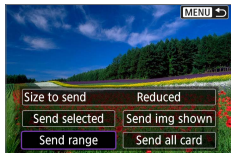

2 Select [Send range].

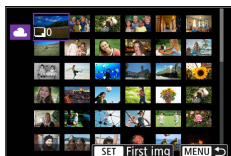

3 Specify the range of images.

- Select the first image (start point).
- Select the last image (end point).
- ➔ Images will be selected and [✓] will appear.
- To cancel the selection, repeat this step.
- You can press the <[checkmark]•[magnifying glass]> button to change the number of images shown in the index display.

4 Confirm the range.

- Press the <MENU> button.

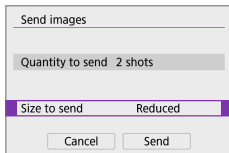

5 Select [Size to send].

- On the displayed screen, select an image size.

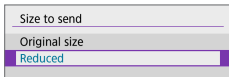

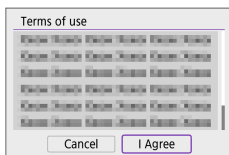
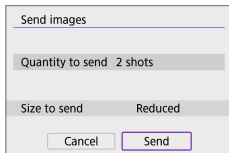

6 Select [Send].

- On the screen after images are sent, select **[OK]** to end the Wi-Fi connection.
- When the **[Terms of use]** screen is displayed, thoroughly read the message, then select **[I Agree]**.
- To scroll the screen, use the **<▲>** **<▼>** keys.

Sending All Images on the Card

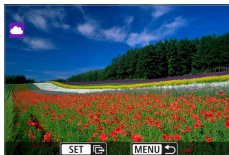

1 Press <SET>.

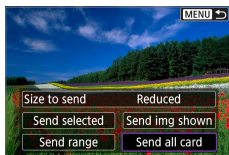

2 Select [Send all card].

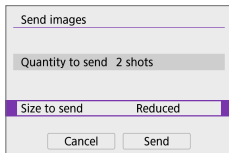

3 Select [Size to send].

- On the displayed screen, select an image size.

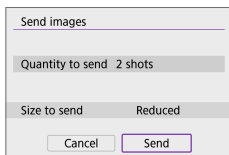
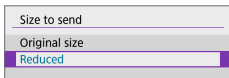

4 Select [Send].

- On the screen after images are sent, select **[OK]** to end the Wi-Fi connection.

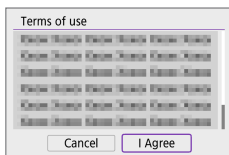

- When the **[Terms of use]** screen is displayed, thoroughly read the message, then select **[I Agree]**.
- To scroll the screen, use the <▲> <▼> keys.

Sending Images that Match the Search Conditions

Send all the images that match the search conditions set in **[Set image search conditions]** at once.

For **[Set image search conditions]**, refer to “Filtering Images for Playback” (p.291).



1 Press <SET>.

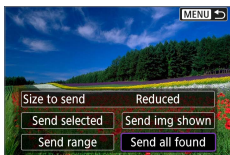

2 Select [Send all found].

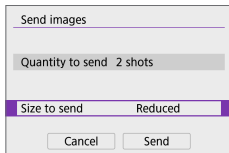

3 Select [Size to send].

- On the displayed screen, select an image size.

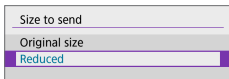

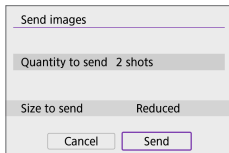

4 Select [Send].

- On the screen after images are sent, select **[OK]** to end the Wi-Fi connection.
- When the **[Terms of use]** screen is displayed, thoroughly read the message, then select **[I Agree]**.
- To scroll the screen, use the **<▲>** **<▼>** keys.

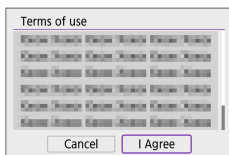

- With a Wi-Fi connection to a Web service established, a picture cannot be taken even if the camera's shutter button is pressed.
- When sending an image to a Web service other than CANON iMAGE GATEWAY, a send error message may not be displayed even if the image has not been sent to the Web service successfully. Since such send errors can be checked on the CANON iMAGE GATEWAY site, check the error content, then try sending the image again.



- Depending on the Web service, the type or number of images that can be sent and the length of movies will be limited.
- Certain images may not be able to be sent with **[Send range]**, **[Send all card]**, or **[Send all found]**.
- When you reduce the image size, all images to be sent at the same time are resized. Note that movies or **S2** size still photos are not reduced.
- **[Reduced]** is enabled only for still photos shot with cameras of the same model as this camera. Still photos shot with other models are sent without resizing.
- When accessing CANON iMAGE GATEWAY, you can check the send history for the Web services that the images were sent to.
- When you use a battery to power the camera, make sure it is fully charged.

Wi-Fi Connection via Access Points

This section describes how to join a Wi-Fi network via an access point compatible with WPS (PCB mode).

First, check the position of the WPS button and how long to press it. It may take approx. one minute to establish a Wi-Fi connection.

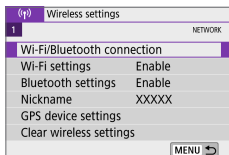

1 Select [Wi-Fi/Bluetooth connection].

- Under the [(F)] tab, select **[Wi-Fi/Bluetooth connection]**, then press <SET>.

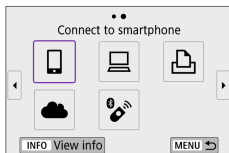

2 Select an item.

- If the history (413) is displayed, switch the screen with the <◀> <▶> keys.

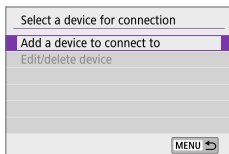

3 Select [Add a device to connect to].

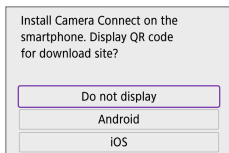

- When [☐] (Connect to smartphone) is selected, the screen on the left is displayed. If Camera Connect is already installed, select **[Do not display]**.
- On the **[Connect to smartphone]** screen displayed next, select **[Connect via Wi-Fi]**, then press <SET>.

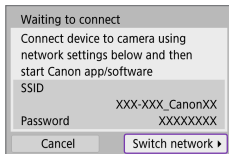

4 Select [Switch network].

- Displayed when [📶], [📶], or [📶] is selected.

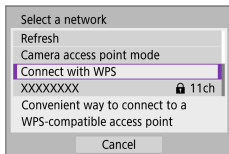

5 Select [Connect with WPS].



- For [Camera access point mode] displayed in step 5, see 📖408.

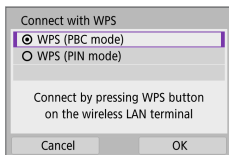

6 Select [WPS (PBC mode)].

- Select [OK].

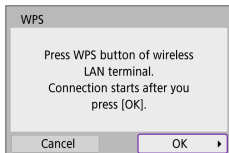

7 Connect to the access point via Wi-Fi.

- Press the access point's WPS button.
- Select [OK].

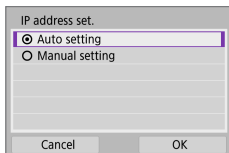

8 Select [Auto setting].

- Select [OK] to access the setting screen for the Wi-Fi function.
- If an error occurs with [Auto setting], see 📖428.

9 Specify the settings for the Wi-Fi function.

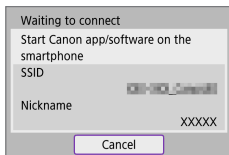

[📱 Connect to smartphone]

- On the smartphone's Wi-Fi setting screen, tap the SSID (network name) shown on the camera, then enter the password of the access point for the connection.

Go to step 8 on 360.

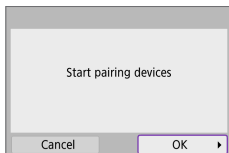

[🖨️ Remote control (EOS Utility)]

Go to step 7 or 8 on 376.

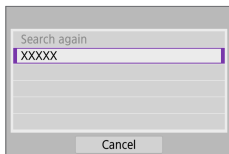

[📄 Print from Wi-Fi printer]

Go to step 6 on 382.

Registering CANON IMAGE GATEWAY

Go to step 5 on 393.

Send To Screen

A screen to select a destination may be displayed depending on the Web service.

To register destinations or to specify the settings, you must use a computer. For more information, refer to the EOS Utility Instruction Manual.

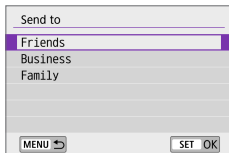

- The **[Send to]** screen may be displayed.
- Select the destination from the list of registered destinations.
- The procedures for setting up a connection and sending images are the same as those for other Web services.

Camera Access Point Mode

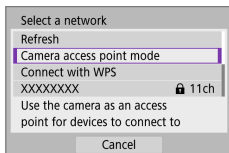

Camera access point mode is a connection mode for connecting the camera directly to each device via Wi-Fi.

Displayed when [📷], [📺], or [📱] is selected in [(?): Wi-Fi/Bluetooth connection].

Manual IP Address Setup

The items displayed vary depending on the Wi-Fi function.

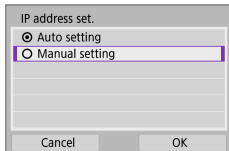

- 1 **Select [Manual setting].**
 - Select **[OK]**.

IP address set.	
IP address	192.168.1.2
Subnet mask	255.255.255.0
Gateway	Disable
Cancel	OK

2 Select an item.

- Select an item to access the screen for numerical input.
- To use a gateway, select **[Enable]**, then select **[Address]**.

Gateway	
<input checked="" type="radio"/> Enable	
<input type="radio"/> Disable	
Address	
0.0.0.0	
Cancel	OK

IP address	
192 . 168 . 1 . 3	↻
0 1 2 3 4 5 6 7 8 9	↕
⏏ ×	INFO Cancel MENU OK

3 Enter the desired values.

- Turn the  dial to move the input position in the upper area and use the <◀> <▶> keys to select the number. Press <SET> to enter the selected number.
- To set the entered values and return to the screen for step 2, press the <MENU> button.

IP address set.	
IP address	192.168.1.3
Subnet mask	255.255.255.0
Gateway	Disable
Cancel	OK

4 Select [OK].

- When you have completed setting the necessary items, select **[OK]**.
- If you are not sure what to enter, see “Checking Network Settings” (📖442), or ask the network administrator or another person knowledgeable about the network.

Connecting to a Wireless Remote Control

This camera can also be connected to Wireless Remote Control BR-E1 (sold separately) via Bluetooth for remote control shooting (📖463).

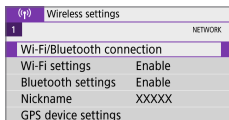

1 Select [Wi-Fi/Bluetooth connection].

- Under the [(📶)] tab, select [Wi-Fi/Bluetooth connection], then press <SET>.

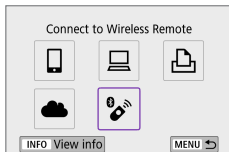

2 Select [📶 Connect to Wireless Remote].

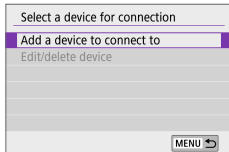

3 Select [Add a device to connect to].

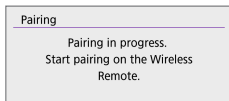

4 Pair the devices.

- When the [Pairing] screen appears, press and hold the <W> and <T> buttons on the BR-E1 simultaneously for at least 3 sec.
- After a message confirms that the camera is paired with the BR-E1, press <SET>.

Still Photo Shooting

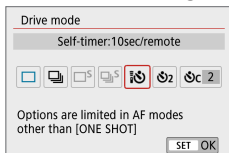

Movie Shooting

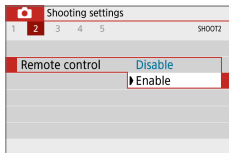

5 Enable remote control shooting.

- Set **[Drive mode]** under the **[📷]** tab to **[i]** (📖112).
- In **[Remote control]** under the **[📷]** tab, select **[Enable]**.
- For instructions after the pairing is complete, refer to the BR-E1's Instruction Manual.



- Bluetooth connections consume battery power even after the camera's auto power off is activated.



- When you do not use Bluetooth function, setting it to **[Disable]** in step 1 is recommended.
- Auto power off will take effect in approx. 2 min. when the camera is set for remote shooting.

Canceling the Pairing

To pair with another BR-E1, clear the connection information of the remote controller currently connected.

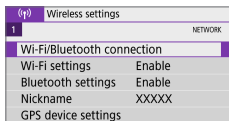

1 Select [Wi-Fi/Bluetooth connection].

- Under the [(P)] tab, select [Wi-Fi/Bluetooth connection], then press <SET>.

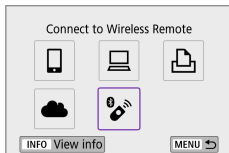

2 Select [Connect to Wireless Remote].

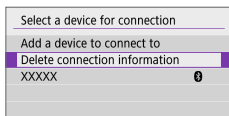

3 Select [Delete connection information].

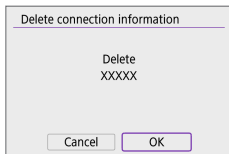

4 Select [OK].

Reconnecting via Wi-Fi

Follow these steps to reconnect to devices or Web services with registered connection settings.

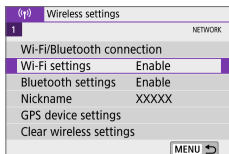

1 Select [Wi-Fi/Bluetooth connection].

- Under the [(P)] tab, select [**Wi-Fi/Bluetooth connection**], then press <SET>.

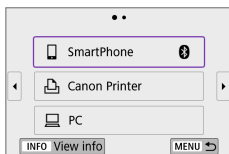

2 Select an item.

- Select the item to connect to via Wi-Fi from the displayed history. If the item is not displayed, use the <◀> <▶> keys to switch screens.
- If [**Connection history**] is set to [**Hide**], the history will not be displayed (📖416).

3 Operate the connected device.

[📱] Smartphone

- Start Camera Connect.
- If the smartphone's connection destination has been changed, restore the setting to connect via Wi-Fi to the camera or the same access point as the camera.

When directly connecting the camera to a smartphone via Wi-Fi, “_Canon0A” is displayed at the end of the SSID.

[💻] Computer

- On the computer, start the EOS software.
- If the computer's connection destination has been changed, restore the setting to connect via Wi-Fi to the camera or the same access point as the camera.

When directly connecting the camera to a computer via Wi-Fi, “_Canon0A” is displayed at the end of the SSID.

Printer

- If the printer's connection destination has been changed, restore the setting to connect via Wi-Fi to the camera or the same access point as the camera.

When directly connecting the camera to a printer via Wi-Fi, “**_Canon0A**” is displayed at the end of the SSID.

Registering Multiple Connection Settings

You can register up to 10 connection settings for the wireless communication functions.

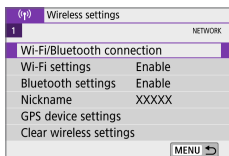

1 Select [Wi-Fi/Bluetooth connection].

- Under the [(P)] tab, select **[Wi-Fi/Bluetooth connection]**, then press <SET>.

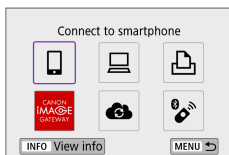

2 Select an item.

- If the history (📖413) is displayed, switch the screen with the <◀> <▶> keys.
- For details on [**📱Connect to smartphone**], see “Connecting to a Smartphone” (📖349).
- For details on [**💻Remote control (EOS Utility)**], see “Connecting to a Computer via Wi-Fi” (📖374).
- For details on [**🖨️Print from Wi-Fi printer**], see “Connecting to a Printer via Wi-Fi” (📖381).
- When sending images to a Web service, see “Sending Images to a Web Service” (📖391).



- To delete connection settings, see 📖423.

Wi-Fi Settings

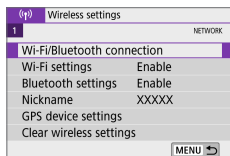

1 Select [Wi-Fi settings].

- Under the [(P)] tab, select **[Wi-Fi settings]**, then press <SET>.

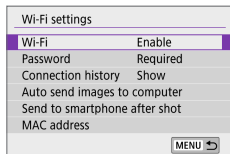

2 Select an item.

- **Wi-Fi**

When the use of electronic devices and wireless devices is prohibited, such as on board airplanes or in hospitals, set it to **[Disable]**.

- **Password**

Set to **[None]** to allow a Wi-Fi connection to be established without a password (except when connecting to an access point via Wi-Fi).

- **Connection history**

You can set whether to **[Show]** or **[Hide]** the history of the Wi-Fi connected devices.

- **Auto send images to computer**

With the dedicated software Image Transfer Utility 2, you can send images on the camera to a computer automatically (📖378).

- **Send to smartphone after shot**

Your shots can be sent to a smartphone automatically (📖362).

- **MAC address**

You can check the MAC address of the camera.

Bluetooth Settings

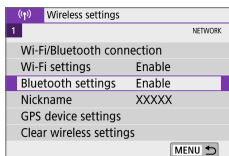

- 1 Choose **[Bluetooth settings]**.
 - Under the [(P)] tab, select **[Bluetooth settings]**, then press <SET>.

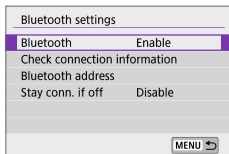

- 2 Select an item.

- **Bluetooth**

If you will not use the Bluetooth function, select **[Disable]**.

- **Check connection information**

You can check the name and communication status of the paired device.

- **Bluetooth address**

You can check the camera's Bluetooth address.

- **Stay conn. if off**

Displayed after the camera is paired with a smartphone via Bluetooth. Selecting **[Enable]** lets you view images on the camera and control it in other ways by connecting via Wi-Fi even if the camera is off (356).

Changing the Nickname

You can change the camera nickname (displayed on smartphones and other cameras) as needed.

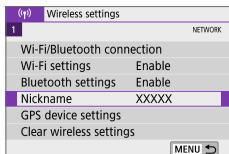

1 Choose [Nickname].

- Under the [(P)] tab, select [Nickname], then press <SET>.

2 Enter text using the virtual keyboard (427).

- When you finish entering characters, press the <MENU> button, then select [OK].

Geotagging Images with GPS Information from Other Devices

You can geotag images with GPS Receiver GP-E2 (sold separately) or a Bluetooth enabled smartphone.

GP-E2

1 Attach the GP-E2 to the camera.

- Attach GP-E2 to the camera's hot shoe and turn it on. For details, refer to the GP-E2 Instruction Manual.

2 Select [GPS device settings].

- Under the [(P)] tab, select [GPS device settings], then press <SET>.

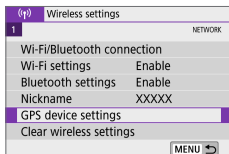

3 In [Select GPS device], select [GPS receiver].

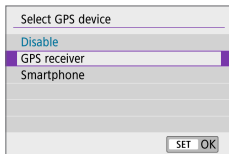

4 Take the picture.

- For the details of [Set up], refer to the GP-E2 Instruction Manual.



Cautions for Using GP-E2

- At first, check the countries and regions where the use of GPS is allowed, and follow their legal restrictions.
- Update the GP-E2 firmware to Version 2.0.0 or later. Firmware updating requires an interface cable. For how to update the GP-E2 firmware, refer to the Canon Web site.
- The cable cannot be used to connect the camera to the GP-E2.
- The camera does not record the shooting direction.

Smartphone

Complete these settings after installing the dedicated Camera Connect app (📖350) on the smartphone.

1 Turn on the smartphone's location information function.

2 Connect to Bluetooth.

- Connect the camera to a smartphone via Bluetooth (📖351).

3 Select [GPS device settings].

- Under the [(📶)] tab, select [GPS device settings], then press <SET>.

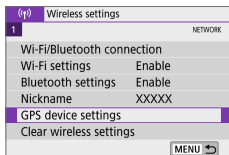

4 Select [Smartphone] in [Select GPS device].

- After these settings are complete, start Camera Connect.

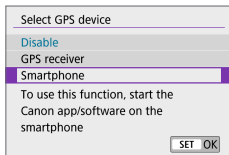

5 Take the picture.

- The location information acquired by the smartphone will be appended to the image.

GPS Connection Display

You can check the status of smartphone location information acquisition in the GPS connection icon on the screens for still photo or movie shooting (📖184 and 📖223, respectively).

- Gray: Location services are off.
- Blinking: Location information cannot be acquired.
- On: Location information acquired.

Regarding the GPS connection indicator status for when the GP-E2 is used, refer to the GP-E2 Instruction Manual.

Geotagging the Image when Taking Pictures

Images you shoot while the GPS icon is on are geotagged.

Location Information Appended to the Image

On the shooting information screen (📖101), you can check the location information appended to the captured image.

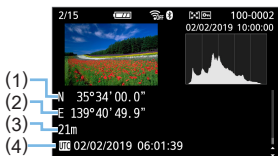

- (1) Latitude
- (2) Longitude
- (3) Elevation
- (4) UTC (Coordinated Universal Time)



- The smartphone can acquire location information only when the camera is connected to a smartphone via Bluetooth.
- Direction information is not acquired.
- The acquired location information may not be accurate depending on the travel conditions and the smartphone's status.
- It may take some time to acquire location information from the smartphone after you turn the camera on.
- Location information is no longer acquired after any of the following operations.
 - Pairing with a wireless remote control via Bluetooth.
 - Turning off the camera.
 - Terminating Camera Connect.
 - Turning off the smartphone's location information function.
- Location information is no longer acquired in any of the following situations.
 - The camera power turns off.
 - Bluetooth connection is terminated.
 - The smartphone's remaining battery level is low.



- Coordinated Universal Time, abbreviated as UTC, is essentially the same as Greenwich Mean Time.
- When shooting a movie, the GPS information at the starting time of the movie shooting is appended.

Changing or Deleting Connection Settings

To change or delete the connection settings, terminate the Wi-Fi connection first.

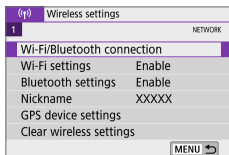

1 Select [Wi-Fi/Bluetooth connection].

- Under the [(P)] tab, select [Wi-Fi/Bluetooth connection], then press <SET>.



2 Select an item.

- If the history (📖413) is displayed, switch the screen with the <◀> <▶> keys.

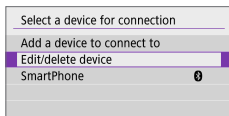

3 Select [Edit/delete device].

- You can change the Bluetooth connection by selecting a smartphone labeled with [📶] in gray. After the [Connect to smartphone] screen is displayed, select [Pair via Bluetooth], then press <SET> on the next screen.

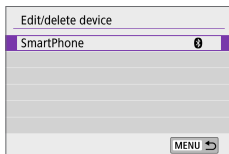

4 Select the device for which to change or delete the connection settings.

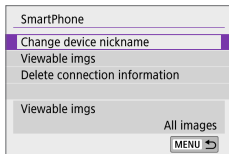

5 Select an item.

- Change or delete the connection settings on the displayed screen.

- **Change device nickname**

You can change the nickname using the virtual keyboard (📖427).

- **Viewable imgs (📖370)**

Displayed when [**Connect to smartphone**] is selected. Settings will appear at the bottom of the screen.

- **Delete connection information**

When deleting connection information for a paired smartphone, also delete the camera information registered on the smartphone (📖357).



- For Web services, visit the CANON iMAGE GATEWAY website to delete the connection settings.

Clearing Wireless Communication Settings to Default

All wireless communication settings can be deleted. By deleting the wireless communication settings, you can prevent their information from being exposed when you lend or give your camera to other people.

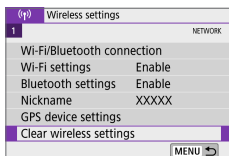

1 Select [Clear wireless settings].

- Under the [(P)] tab, select [Clear wireless settings], then press <SET>.

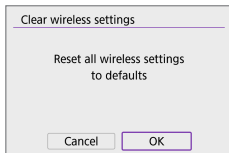

2 Select [OK].



- Performing [**P**: Clear all camera settings] does not delete the wireless communication setting information.
- If you have paired the camera with a smartphone, on the smartphone's Bluetooth settings screen, delete the connection information of the camera for which you restored default wireless communication settings.

View Info Screen

You can check error details and the camera's MAC address.

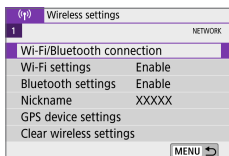

1 Select [Wi-Fi/Bluetooth connection].

- Under the [(Wi-Fi)] tab, select [Wi-Fi/Bluetooth connection], then press <SET>.

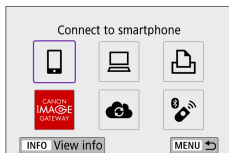

2 Press the <INFO> button.

- The [View info] screen will appear.

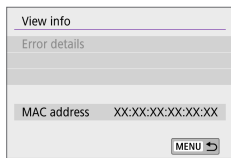

- When an error has occurred, press <SET> to display the error content.

Virtual Keyboard Operation

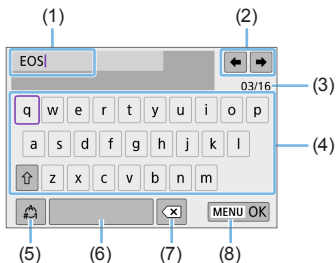

(1) Input area, for entering text

(2) Cursor keys, for moving in the input area

(3) Current no. of characters/no. available

(4) Keyboard

(5) Switch input modes

(6) Space

(7) Delete a character in the input area

(8) Finish the text entry

- Press the <↔> cross keys to move within 2 and 4–7.
- Press <SET> to confirm input or when switching input modes.

Responding to Error Messages

When an error occurs, display the details of the error by following one of the procedures below. Then, eliminate the cause of the error by referring to the examples shown in this chapter.

- On the **[View info]** screen, press <SET> (📖426).
- Select **[Error details]** on the **[Wi-Fi on]** screen.

Click the error code number's page in the following chart to jump to the corresponding page.

11 (📖429)	12 (📖429)	21 (📖430)	22 (📖431)
23 (📖432)	61 (📖433)	63 (📖434)	64 (📖434)
65 (📖435)	66 (📖435)	67 (📖435)	68 (📖436)
69 (📖436)	91 (📖436)	121 (📖436)	125 (📖437)
126 (📖437)	127 (📖437)	141 (📖437)	142 (📖437)
151 (📖438)	152 (📖438)		



- When an error occurs, **[Err**]** is displayed on the upper right of the **[Wi-Fi/Bluetooth connection]** screen. It disappears when the camera's power is set to <OFF>.

11: Connection target not found

- In the case of [📷], is Camera Connect running?
➔ Establish a connection using Camera Connect (📖360).
- In the case of [📱], is the EOS software running?
➔ Start the EOS software and reestablish the connection (📖376).
- In the case of [🖨️], is the power of the printer on?
➔ Turn on the printer.
- Are the camera and the access point set to use the same password for authentication?
➔ This error occurs if the passwords do not match when the authentication method for encryption is set to **[Open system]**.
The setting is case-sensitive, so check upper- and lower-case characters. Make sure that the correct password for authentication is set on the camera (📖427).

12: Connection target not found

- Is the power of the target device and access point on?
➔ Turn on the target device and access point, then wait a while. If a connection still cannot be established, perform the procedures to establish the connection again.

21: No address assigned by DHCP server

What to check on the camera

- On the camera, IP address is set to **[Auto setting]**. Is this the correct setting?
 - ➔ If no DHCP server is used, specify the settings after setting the IP address to **[Manual setting]** on the camera (📖408).

What to check on the DHCP server

- Is the power of the DHCP server on?
 - ➔ Turn on the DHCP server.
- Are there enough addresses for assignment by the DHCP server?
 - ➔ Increase the number of addresses assigned by the DHCP server.
 - ➔ Remove devices assigned addresses by the DHCP server from the network to reduce the number of addresses in use.
- Is the DHCP server working correctly?
 - ➔ Check the DHCP server settings to make sure it is working correctly as a DHCP server.
 - ➔ If applicable, ask your network administrator to ensure the DHCP server is available.

22: No response from DNS server

What to check on the camera

- On the camera, does the DNS server's IP address setting match the server's actual address?
 - ➔ Set the IP address to **[Manual setting]**. Then, on the camera, set the IP address that matches the address of the DNS server used (📖408, 📖442).

What to check on the DNS server

- Is the power of the DNS server on?
 - ➔ Turn on the DNS server.
- Are the DNS server settings for IP addresses and the corresponding names correct?
 - ➔ On the DNS server, make sure IP addresses and the corresponding names are entered correctly.
- Is the DNS server working correctly?
 - ➔ Check the DNS server settings to make sure it is working correctly as a DNS server.
 - ➔ If applicable, ask your network administrator to ensure the DNS server is available.

What to check on the network as a whole

- Does the network that you are trying to connect to via Wi-Fi include a router or similar device that serves as a gateway?
 - ➔ If applicable, ask your network administrator for the network gateway address and enter it on the camera (📖408, 📖442).
 - ➔ Make sure that the gateway address setting is correctly entered on all network devices including the camera.

23: Device with same IP address exists on selected network

What to check on the camera

- Do the camera and another device connected via Wi-Fi to the same network have the same IP address?
 - ➔ Change the camera's IP address to avoid using the same address as another device on the network. Otherwise, change the IP address of the device that has a duplicate address.
 - ➔ If the camera's IP address is set to **[Manual setting]** in network environments using a DHCP server, change the setting to **[Auto setting]** (📖406).



Responding to Error Messages 21–23

- Also check the following points when responding to errors numbered 21–23.
- **Are the camera and the access point set to use the same password for authentication?**
 - This error occurs if the passwords do not match when the authentication method for encryption is set to **[Open system]**. The setting is case-sensitive, so check upper- and lower-case characters. Make sure that the correct password for authentication is set on the camera (📖427).

61: Selected SSID wireless LAN network not found

- Are any obstacles blocking the line of sight between the camera and the antenna of the access point?
 - ➔ Move the antenna of the access point to a position clearly visible from the point of view of the camera (📖439).

What to check on the camera

- Does the SSID set on the camera match that of the access point?
 - ➔ Check the SSID at the access point, then set the same SSID on the camera.

What to check at the access point

- Is the access point turned on?
 - ➔ Turn on the power of the access point.
- If filtering by MAC address is active, is the MAC address of the camera in use registered at the access point?
 - ➔ Register the MAC address of the camera used to the access point. The MAC address can be checked on the **[View info]** screen (📖426).

63: Wireless LAN authentication failed

- Are the camera and the access point set to use the same authentication method?
 - ➔ The camera supports the following authentication methods: **[Open system]**, **[Shared key]**, and **[WPA/WPA2-PSK]**.
- Are the camera and the access point set to use the same password for authentication?
 - ➔ The setting is case-sensitive, so check upper- and lower-case characters. Make sure that the correct password for authentication is set on the camera.
- If filtering by MAC address is active, is the MAC address of the camera in use registered at the access point?
 - ➔ Register the MAC address of the camera used to the access point. The MAC address can be checked on the **[View info]** screen (📖426).

64: Cannot connect to wireless LAN terminal

- Are the camera and the access point set to use the same encryption method?
 - ➔ The camera supports the following encryption methods: WEP, TKIP, and AES.
- If filtering by MAC address is active, is the MAC address of the camera in use registered at the access point?
 - ➔ Register the MAC address of the camera used to the access point. The MAC address can be checked on the **[View info]** screen (📖426).

65: Wireless LAN connection lost

- Are any obstacles blocking the line of sight between the camera and the antenna of the access point?
 - ➔ Move the antenna of the access point to a position clearly visible from the point of view of the camera (📖439).
- The Wi-Fi connection was lost for some reason, and the connection cannot be restored.
 - ➔ The following are possible reasons: excessive access to the access point from another device, a microwave oven or similar appliance in use nearby (interfering with IEEE 802.11b/g/n (2.4 GHz band)), or influence of rain or high humidity (📖439).

66: Incorrect wireless LAN password

- Are the camera and the access point set to use the same password for authentication?
 - ➔ The setting is case-sensitive, so check upper- and lower-case characters. Make sure that the correct password for authentication is set on the camera.

67: Incorrect wireless LAN encryption method

- Are the camera and the access point set to use the same encryption method?
 - ➔ The camera supports the following encryption methods: WEP, TKIP, and AES.
- If filtering by MAC address is active, is the MAC address of the camera in use registered at the access point?
 - ➔ Register the MAC address of the camera used to the access point. The MAC address can be checked on the **[View info]** screen (📖426).

68: Cannot connect to wireless LAN terminal. Retry from the beginning.

- Did you hold down the access point's WPS (Wi-Fi Protected Setup) button for the specified period of time?
 - ➔ Hold down the WPS button for the period of time specified in the access point's instruction manual.
- Are you trying to establish a connection near the access point?
 - ➔ Try establishing the connection when both devices are within reach of each other.

69: Multiple wireless LAN terminals have been found. Cannot connect. Retry from the beginning.

- Connection is in progress by other access points in Pushbutton Connection mode (PBC mode) of WPS (Wi-Fi Protected Setup).
 - ➔ Wait a while before trying to establish the connection.

91: Other error

- A problem other than error code number 11 to 69 occurred.
 - ➔ Turn the camera's power switch off and on.

121: Not enough free space on server

- The target Web server does not have enough free space.
 - ➔ Delete unnecessary images on the Web server, check the free space on the Web server, then try sending the data again.

125: Check the network settings

- Is the network connected?
 - ➔ Check the connection status of the network.

126: Could not connect to server

- CANON iIMAGE GATEWAY is under maintenance or load is concentrated temporarily.
 - ➔ Try connecting to the Web service again later.

127: An error has occurred

- A problem other than error code number 121 to 126 occurred while the camera is connected to the Web service.
 - ➔ Try again to establish the Wi-Fi connection to the Web service.

141: Printer is busy. Reconnect to try again.

- Is the printer performing a printing process?
 - ➔ Try again to establish the Wi-Fi connection to the printer after the printing process is finished.
- Is another camera connected to the printer via Wi-Fi?
 - ➔ Try again to establish the Wi-Fi connection to the printer after the Wi-Fi connection to the other camera has been terminated.

142: Could not acquire printer information. Reconnect to try again.

- Is the power of the printer on?
 - ➔ Try again to establish the Wi-Fi connection after turning on the printer.

151: Transmission canceled

- Automatic image transfer to the computer was somehow interrupted.
 - ➔ To resume automatic image transfer, set the camera's power switch to <OFF>, and then set it to <ON>.

152: Card's write protect switch is set to lock

- Is the card's write protect switch set to the locked position?
 - ➔ Slide the card's write protect switch to the writing position.

Wireless Communication Function Notes

If the transmission rate drops, the connection is lost, or other problems occur when using the wireless communication functions, try the following corrective actions.

Distance Between the Camera and the Smartphone

If the camera is too far from the smartphone, a Wi-Fi connection may not be established even when Bluetooth connection is possible. In this case, bring the camera and the smartphone closer together, then establish a Wi-Fi connection.

Installation Location of Access Point Antenna

- When using indoors, install the device in the room where you are using the camera.
- Install the device where people or objects do not come between the device and the camera.

Nearby Electronic Devices



If the Wi-Fi transmission rate drops because of the influence of the following electronic devices, stop using them or move further away from the devices to transmit communication.

- The camera communicates over Wi-Fi via IEEE 802.11b/g/n using radio waves in the 2.4 GHz band. For this reason, the Wi-Fi transmission rate will drop if there are Bluetooth devices, microwave ovens, cordless telephones, microphones, smartphones, other cameras, or similar devices operating on the same frequency band nearby.

Cautions for Using Multiple Cameras

- When connecting multiple cameras to one access point via Wi-Fi, make sure the cameras' IP addresses are different.
- When multiple cameras are connected to one access point via Wi-Fi, the transmission rate drops.
- When there are multiple IEEE 802.11b/g/n (2.4 GHz band) access points, leave a gap of five channels between each Wi-Fi channel to reduce radio wave interference. For example, use channels 1, 6, and 11, channels 2 and 7, or channels 3 and 8.

Using the Wireless Remote Control BR-E1

- BR-E1 cannot be used while the camera and smartphone are paired via Bluetooth. Change the camera connection to the wireless remote in [ **Connect to Wireless Remote**] under [ **Wi-Fi/Bluetooth connection**].

Security

If security settings have not been properly set, the following problems may occur.

- **Transmission monitoring**

Third parties with malicious intent may monitor the Wi-Fi transmissions and attempt to acquire the data you are sending.

- **Unauthorized network access**

Third parties with malicious intent may gain unauthorized access to the network you are using to steal, modify, or destroy information. Additionally, you could fall victim to other types of unauthorized access such as impersonation (where someone assumes an identity to gain access to unauthorized information) or springboard attacks (where someone gains unauthorized access to your network as a springboard to cover their tracks when infiltrating other systems).

It is recommended to make use of the systems and functions to thoroughly secure your network, preventing these types of problems from occurring.

Checking Network Settings

- **Windows**

Open the Windows **[Command Prompt]**, then type `ipconfig/all` and press the **<Enter>** key.

In addition to the IP address assigned to the computer, the subnet mask, gateway, and DNS server information are also displayed.

- **Mac OS**

In Mac OS X, open the **[Terminal]** application, enter `ifconfig -a`, and press the **<Return>** key. The IP address assigned to the computer is indicated in the **[en0]** item next to **[inet]**, in the format `“***.***.***.***”`.

* For information about the **[Terminal]** application, refer to the Mac OS X help.

To avoid using the same IP address for the computer and other devices on the network, change the rightmost number when setting up the IP address assigned to the camera in the processes described on  408.

Example: 192.168.1.**10**

Wireless Communication Status

Wireless communication status can be checked on the LCD monitor.

Quick Control screen



(2) (3)
(1)

Information display screen during playback





(2)
(1) (3)

- (1) Wireless signal strength
- (2) Wi-Fi function
- (3) Bluetooth function

Communication status		LCD monitor	
		Wi-Fi function	Wireless signal strength
Not connected	Wi-Fi: Disable		Off
	Wi-Fi: Enable		
Connecting		(Blinking)	
Connected			
Sending data		(←→)	
Connection error		(Blinking)	

Bluetooth Function Indicator

Bluetooth function	Connection status	LCD monitor
Other than [Disable]	Bluetooth connected	
	Bluetooth not connected	
[Disable]	Bluetooth not connected	Not displayed



- “Bluetooth connected” status is indicated when connected to smartphones via Wi-Fi and during automatic image transfer to computers.
- “Bluetooth not connected” status is indicated when connected to computers, printers, or Web services via Wi-Fi.

Customizing the Camera

You can make fine adjustments to various camera functions to suit your picture-taking preferences with Custom Functions. Custom Functions can be set and work only in Creative Zone modes.

Creative Zone modes

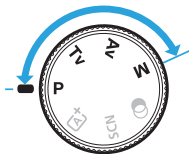

Setting Custom Functions

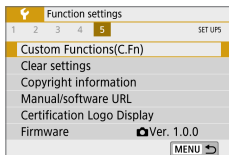

1 Select [Custom Functions(C.Fn)].

- Under the [**F**] tab, select [**Custom Functions(C.Fn)**], then press <SET>.

(1)

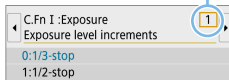

2 Select the Custom Function number (1).

- Press the <<> <>> keys to select the Custom Function number, then press <SET>.

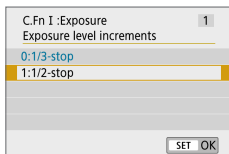

3 Change the setting as desired.

- Press the <▲> <▼> keys to select the desired setting (number), then press <SET>.
- Repeat steps 2 to 3 if you want to set other Custom Functions.
- At the bottom of the screen, the current Custom Function settings are indicated below the respective function numbers.

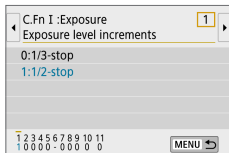

4 Exit the setting.

- Press the <MENU> button.
- ➔ The screen in step 1 will reappear.

Clearing All Custom Functions

Under [**F** : **Clear settings**], select [**Clear all Custom Func. (C.Fn)**] to clear all the Custom Function settings (📖271).

Custom Functions

C.Fn I: Exposure

1	Exposure level increments	448
2	ISO expansion	448
3	Safety shift	448
4	Exposure compensation auto cancel	449

LV Shooting	Movie Shooting
○	○
○	○
○	○

C.Fn II: Drive

5	Mirror lockup	449
---	---------------	-----

--	--

C.Fn III: Operation/Others

6	Warnings in viewfinder	450
7	Shutter/AE lock button	451
8	Assign SET button	452
9	DISP button function	453
10	Screen display when power ON	453
11	Retract lens on power off	454

○	○
○ (Except 3)	○ (4 and 5 only*)
○ (Except 4)	○ (Except 1)
○	○

* Setting 4 does not function during movie shooting.



- Shaded Custom Functions do not function during Live View (LV) shooting or movie shooting. (Settings are disabled.)

Custom Function Setting Items



Custom Functions are organized into three groups based on the function type: C.Fn I: Exposure, C.Fn II: Drive, C.Fn III: Operation/Others.

C.Fn I: Exposure

C.Fn-1 Exposure level increments

0: 1/3-stop

1: 1/2-stop

Sets 1/2-stop increments for the shutter speed, aperture, exposure compensation, AEB, flash exposure compensation, etc. Useful when 1/3-stop increments are too fine.



- When set to 1, exposure level display is as follows in the viewfinder.



C.Fn-2 ISO expansion

0: Off

1: On

When you set the ISO speed, you can set “H” (equivalent to ISO 51200) for still photos and “H” (equivalent to ISO 25600) for movies. Note that if [: **Highlight tone priority**] is set to [**Enable**] or [**Enhanced**], “H” cannot be selected.



- For 4K movies, the ISO speed range is ISO 100–6400, even when [**ISO expansion**] is set to [**1: On**].

C.Fn-3 Safety shift

0: Disable

1: Enable

For automatic adjustment of the shutter speed and aperture value to bring the exposure level closer to standard exposure if standard exposure would not be available otherwise under your specified shutter speed or aperture value in <**Tv**> or <**Av**> mode.

C.Fn-4 Exposure compensation auto cancel

0: Enable

When you set the power switch to <OFF>, the exposure compensation setting will be canceled.

1: Disable

The exposure compensation setting will remain in effect even if you set the power switch to <OFF>.

C.Fn II: Drive

C.Fn-5 Mirror lockup

0: Disable

1: Enable

You can prevent the camera vibration blur due to the mechanical vibrations (mirror shock) inside the camera during shooting with super telephoto lenses or shooting close-ups (macro photography). See page 165 for the mirror lockup procedure.

C.Fn III: Operation/Others

C.Fn-6 Warnings <!> in viewfinder

When any of the following functions are set, the <!> icon can be displayed on the viewfinder's bottom left (📖32). The <!> icon will also appear on the Quick Control screen (📖57).

Select the function for which you want the warning icon to appear, press <SET> to add a checkmark [✓], then select [OK].

When monochrome set:

If the Picture Style is set to [Monochrome] (📖121), the warning icon will appear.

When WB is corrected:

If white balance correction is set (📖133), the warning icon will appear.

When is set:

If [: High ISO speed NR] is set to [Multi Shot Noise Reduction] (📖138), the warning icon will appear.

When spot meter. is set:

If [: Metering mode] is set to [Spot metering] (📖158), the warning icon will appear.



- When [: Shooting screen] is set to [Guided], this Custom Function does not function. (Settings do not take effect.)

0: AF/AE lock

1: AE lock/AF

This is convenient when you want to focus and meter separately. Press the <✳> button to autofocus, and press the shutter button halfway to apply AE lock.

2: AF/AF lock, no AE lock

During AI Servo AF (or Servo AF for Live View shooting), you can press the <✳> button to pause the AF operation momentarily. This prevents the AF from being thrown off by any obstacle passing between the camera and subject. The exposure is set at the moment the picture is taken.

3: AE/AF, no AE lock

This is useful for subjects that keep moving and stopping repeatedly. During AI Servo AF (or Servo AF for Live View shooting), you can press the <✳> button to start or stop the AI Servo AF operation. The exposure is set at the moment the picture is taken. Thus, you can set your camera to always maintain the optimum focusing and exposure and wait for the decisive moment.



During movie shooting

- With setting 1 or 3, press the <✳> button for One-Shot AF.

You can assign a frequently-used function to <SET>. When the camera is ready to shoot, pressing the <SET> button will display the respective function setting screen.

0: Quick Control screen

The Quick Control screen ( 57) will appear.

1: Image quality

The image quality setting screen will appear.

2: Flash exposure comp.

The flash exposure compensation setting screen will appear.

3: Screen On/Off

You can turn on or off the LCD monitor.

4: Menu display

The menu screen will appear.

5: Expo comp (hold btn, turn)

You can set the exposure compensation by turning the <> dial while holding down <SET>. Useful when you want to set exposure compensation in <M> manual exposure with ISO Auto set.

6: Flash function settings

The built-in flash or external flash function setting screen will appear.

7: Depth-of-field preview

The lens will stop down to the set aperture, and you can see the range of acceptable focus (depth of field) in the viewfinder or in the Live View image.

C.Fn-9 DISP button function

You can assign a frequently used function to the <DISP> button. When the camera is ready to shoot, pressing the <DISP> button will display the respective function setting screen.

0: Screen On/Off

You can turn on or off the LCD monitor.

1: Depth-of-field preview

The lens will stop down to the set aperture, and you can see the range of acceptable focus (depth of field) in the viewfinder or in the Live View image.

2: Wi-Fi/Bluetooth connection

The setting screen for Wi-Fi/Bluetooth connections will appear. The **[Wi-Fi on]** screen is displayed when connected via Wi-Fi.

3: Max. screen brightness (temp)

Temporarily increases screen brightness.

4: Pause Movie Servo AF

You can pause Movie Servo AF.

C.Fn-10 Screen display when power ON

0: Display on

When you turn on the power, the Quick Control screen will appear (57).

1: Previous display status

When you turn on the power, the camera will start with the LCD monitor display in the state it was in when the power was last turned off. Therefore, if you turn off the camera when the LCD monitor is off, nothing will be displayed when you turn on the camera again. This helps to save battery power. The menu operations and image playback will be available as usual.

C.Fn-11 Retract lens on power off

This is the setting for the lens retraction mechanism when a gear-driven STM lens (such as EF40mm f/2.8 STM) is attached to the camera. You can set it to retract the extended lens automatically when the camera's power switch is set to <OFF>.

0: Enable

1: Disable



- With auto power off, the lens will not retract regardless of the setting.
- Before detaching the lens, make sure that it is retracted.



- With setting 0, this function takes effect regardless of the lens's focus mode switch setting (AF or MF).

Registering My Menu



Under My Menu tab, you can register menu items and Custom Functions whose settings you change frequently. You can also name the registered menu tabs, and press the <MENU> button to display the My Menu tab first.



- When [**☰** : Menu display] is set to [Guided], the [**★**] tab will not be displayed. Change the [Menu display] to [Standard] (p.53).

Creating and Adding My Menu Tab

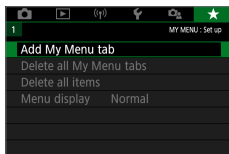

1 Select [Add My Menu tab].

- Under the [**★**] tab, select **Add My Menu tab**, then press <SET >.

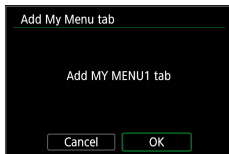

2 Select [OK].

- The [**MY MENU1**] tab is created.
- You can create up to five My Menu tabs by repeating steps 1 and 2.

Registering Menu Items under the My Menu Tab(s)

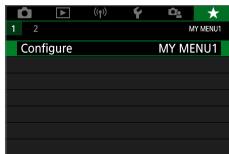

1 Select [Configure: MY MENU*].

- Press the <◀> <▶> keys to select [**Configure: MY MENU***] (tab for registering menu items), then press <SET >.

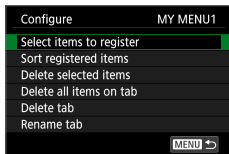

2 Select [Select items to register].

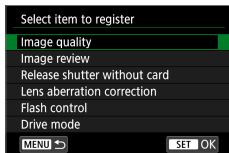

3 Register the desired items.

- Select the desired item, then press <SET>.
- Select [OK] on the confirmation dialog.
- You can register up to six items.
- To return to the screen in step 2, press the <MENU> button.

My Menu Tab Settings

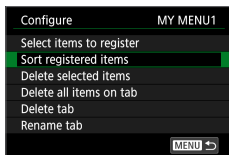

You can sort and delete items under the menu tab, and rename or delete the menu tab.

• Sort registered items

You can change the order of the registered items in My Menu. Select [**Sort registered items**] and select the item whose order you want to change. Then press <SET>. With [**◆**] displayed, press the <▲> <▼> keys to change the order, then press <SET>.

• Delete selected items / Delete all items on tab

You can delete any of the registered items. [**Delete selected items**] deletes one item at a time, and [**Delete all items on tab**] deletes all the registered items under the tab.

• Delete tab

You can delete the My Menu tab currently displayed. Select [**Delete tab**] to delete the [**MY MENU***] tab.





● Rename tab

You can rename the My Menu tab from **[MY MENU*]**.



1 Select **[Rename tab]**.

2 Enter text.

- Press the <☒> button to delete any unnecessary characters.
- Press the <⬆> cross keys to move the and select the desired character. Then press <SET> to enter it.
- By selecting [, you can change the input mode.
- You can enter up to 16 characters.
- To move the cursor, select [] or [] in the upper right or turn the <> dial.
- To cancel the text entry, press the <MENU> button, then select **[Cancel]**.

3 Exit the setting.

- After entering the text, press the <MENU> button, then select **[OK]**.
- ➔ The set information is saved.

Deleting All My Menu Tabs / Deleting All Items

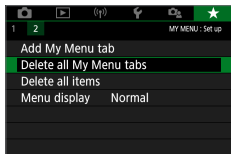

You can delete all the created My Menu tabs or My Menu items registered under them.

- **Delete all My Menu tabs**

You can delete all My Menu tabs you created. When you select [**Delete all My Menu tabs**], all the tabs from [**MY MENU1**] to [**MY MENU5**] will be deleted and the [**★**] tab will revert to its default.

- **Delete all items**

You can delete all the items registered under the [**MY MENU1**] to [**MY MENU5**] tabs. The tab(s) will remain. When [**Delete all items**] is selected, all the items registered under all the created tabs will be deleted.



- If you perform [**Delete tab**] or [**Delete all My Menu tabs**], tab names renamed with [**Rename tab**] will also be deleted.

Menu Display Settings

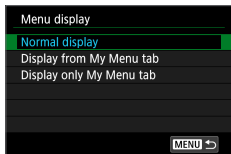

- You can select [**Menu display**] to set the menu screen that is to appear first when you press the <MENU> button.

- **Normal display**

Displays the last displayed menu screen.

- **Display from My Menu tab**

Displays with the [**★**] tab selected.

- **Display only My Menu tab**

Only the [**★**] tab is displayed. (The [**📷**], [**▶**], [**(P)**], [**👉**] and [**📷**] tabs will not be displayed.)

Reference

This chapter provides reference information for camera features, system accessories, etc.



Certification Logo

- Select [**F**: **Certification Logo Display**] and press <SET> to display some of the logos of the camera's certifications. Other certification logos can be found in this Instruction Manual, on the camera body, and on the camera's package.

Checking the Battery Information

You can check the conditions of the battery you are using on the LCD monitor.

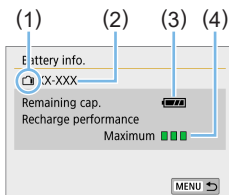
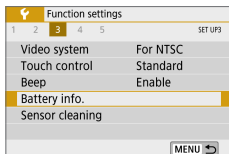

Select [Battery info.].

- Under the [**F**] tab, select [**Battery info.**], then press <SET>.

- Battery position
- Battery model or household power source being used.
- The battery level (📖42) is displayed.
- Battery's recharge performance level is displayed in three levels.
 - ■ ■ : Battery's recharge performance is fine.
 - ■ □ : Battery's recharge performance is slightly degraded.
 - □ □ : Purchasing a new battery is recommended.



- Using a genuine Canon Battery Pack LP-E17 is recommended. If you use batteries that are not genuine Canon products, the camera's full performance may not be attained or malfunction may result.



- If a battery communication error message is displayed, follow the instructions in the message.

Using a Household Power Outlet

You can power the camera with a household power outlet by using the DC Coupler DR-E18 and AC Adapter AC-E6N (each sold separately).

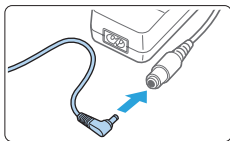

1 Connect the DC coupler's plug.

- Connect the DC coupler's plug to the AC Adapter's socket.

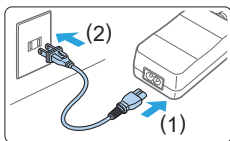

2 Connect the power cord.

- Connect the power cord as shown in the illustration.
- After using the camera, unplug the power plug from the power outlet.

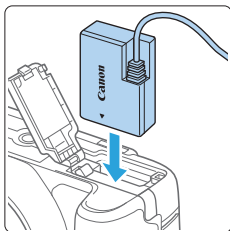

3 Insert the DC coupler.

- Open the cover and insert the DC coupler securely until it locks.

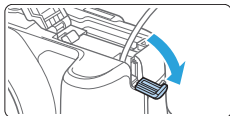

4 Push in the DC cord.

- Open the DC cord hole cover and install the cord as shown in the illustration.
- Close the cover.

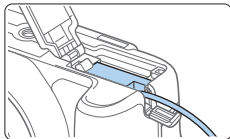



- Do not connect or disconnect the power cord when the camera's power switch is set to <ON>.

Remote Control Shooting

Wireless Remote Control BR-E1 (Sold Separately)

You can shoot remotely up to approx. 5 m/16.4 ft from the camera. After pairing the camera and BR-E1, set the drive mode to **[i] [S]** (📖112). For operating instructions, refer to the BR-E1 Instruction Manual.

Remote Switch RS-60E3 (Sold Separately)

The camera is compatible with the Remote Switch RS-60E3 that comes with an approx. 60 cm/2.0 ft cord. When connected to the camera's remote control terminal, it can be pressed halfway and completely, just like the shutter button.

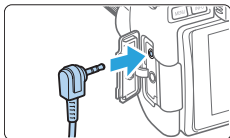

- Remote control shooting is also possible during movie shooting (📖252).

Removing the Eyecup

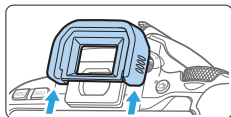

- Push the bottom of the eyecup to detach it.

Troubleshooting Guide

If a problem occurs with the camera, first consult this Troubleshooting Guide. If this Troubleshooting Guide does not resolve the problem, contact your dealer or nearest Canon Service Center.

Power-Related Problems

The battery does not recharge.

- Do not use any battery other than genuine Canon Battery Pack LP-E17.

The battery charger's lamp blinks.

- If (1) the battery charger or battery has a problem or (2) communication with the battery failed (with a non-Canon battery pack), the protection circuit will stop charging, and the charge lamp will blink in orange. In the case of (1), unplug the charger's power plug from the power outlet. Detach and reattach the battery to the charger. Wait two or three minutes, then reconnect the power plug to the power outlet. If the problem persists, contact your dealer or nearest Canon Service Center.

The camera is not activated even when the power switch is set to <ON>.

- Make sure the battery is installed properly in the camera (📖37).
- Make sure the card slot/battery compartment cover is closed (📖37).
- Recharge the battery (📖35).
- Press the <DISP> button (📖68).

The access lamp still blinks even when the power switch is <OFF>.

- If the power is turned off while an image is being recorded to the card, the access lamp will remain on or continue to blink for a few seconds. When the image recording is complete, the power will turn off automatically.

[Battery communication error. Does this battery/do these batteries display the Canon logo?] is displayed.

- Do not use any battery other than genuine Canon Battery Pack LP-E17.
- Remove and install the battery again (📖37).
- If the electrical contacts are dirty, use a soft cloth to clean them.

The battery becomes exhausted quickly.

- Use a fully-charged battery (📖35).
- The battery performance may have degraded. See [**🔧: Battery info.**] to check the battery's recharge performance level (📖460). If the battery performance is poor, replace the battery with a new one.
- The number of possible shots will decrease with any of the following operations:
 - Pressing the shutter button halfway for a prolonged period.
 - Activating the AF frequently without taking a picture.
 - Using the lens's Image Stabilizer.
 - Using the LCD monitor frequently.
 - Continuing Live View shooting or movie shooting for a prolonged period.
 - Using the Bluetooth function.
 - Using the Wi-Fi function.

The camera turns off by itself.

- Auto power off is in effect. If you do not want auto power off to take effect, set [**🔧: Auto power off**] to [**Disable**] (📖261).
- Even if [**🔧: Auto power off**] is set to [**Disable**], the LCD monitor will still turn off after the camera is left idle for approx. 30 min. (The camera's power does not turn off.) Press the <DISP> button to turn on the LCD monitor.

Shooting-Related Problems

The lens cannot be attached.

- The camera cannot be used with RF or EF-M lenses (📖47).

No images can be shot or recorded.

- Make sure the card is properly inserted (📖37).
- Slide the card's write-protect switch to the Write/Erase setting (📖37).
- If the card is full, replace the card or delete unnecessary images to make space (📖37, 📖310).
- You cannot take a picture when focus indicator <●> in the viewfinder blinks during focusing with One-Shot AF. Press the shutter button halfway again to refocus automatically, or focus manually (📖50, 📖111).

The card cannot be used.

- If a card error message is displayed, see 📖38 or 📖477.

An error message is displayed when the card is inserted in another camera.

- Since SDXC cards are formatted in exFAT, if you format a card with this camera and then insert it into another camera, an error may be displayed and it may not be possible to use the card.

The image is out of focus or blurred.

- Set the lens's focus mode switch to <AF> (📖47).
- Press the shutter button gently to prevent camera shake (📖49–📖50).
- With a lens equipped with the Image Stabilizer, set the IS switch to <ON>.
- In low light, the shutter speed may become slow. Use a faster shutter speed (📖149), set a higher ISO speed (📖118), use flash (📖169), or use a tripod.

I cannot lock the focus and recompose the shot.

- Set the AF operation to One-Shot AF. Focus lock is not possible in the AI Servo AF mode or when servo takes effect in AI Focus AF mode (📖195).

Horizontal stripes appear, or the exposure or color tone look strange.

- Horizontal stripes (noise) or irregular exposures can be caused by fluorescent lighting, LED lighting, or other light sources during viewfinder or Live View shooting. Also, the exposure or color tone may not come out right. A slow shutter speed may reduce the problem.

The standard exposure cannot be obtained or the exposure is irregular.

- During viewfinder shooting or Live View shooting, if you use a TS-E lens (except the TS-E17mm f/4L or TS-E24mm f/3.5L II) and shift or tilt the lens or use an extension tube, the standard exposure may not be obtained or the exposure may be irregular.

The continuous shooting speed is slow.

- The maximum continuous shooting speed may become slower depending on the shutter speed, aperture, subject conditions, brightness, lens, flash use, temperature, battery type, remaining battery level, shooting function settings, etc. For details, see page 112.





The maximum burst during continuous shooting is lower.

- Shooting a subject with fine detail, such as a field of grass, increases the file size per image, which may lower the actual maximum burst.

ISO 100 cannot be set.

- ISO 100 is not available when [📷: Highlight tone priority] is set to [Enable] or [Enhanced]. If [Disable] is set, ISO 100 can be set (📖137). This also applies to movie shooting (📖222).



Expanded ISO speeds cannot be selected.

- When [: **Highlight tone priority**] is set to [**Enable**] or [**Enhanced**], the ISO speed range is ISO 200–25600 (up to ISO 12800 for movies or 6400 for 4K movies), even if [**ISO expansion**] is set to [**1:On**]. If [**Disable**] is set for [: **Highlight tone priority**], [**H**] can be set ( 137). This also applies to movie shooting ( 222).

The Auto Lighting Optimizer cannot be set.

- Auto Lighting Optimizer is not available when [: **Highlight tone priority**] is set to [**Enable**] or [**Enhanced**]. If [**Disable**] is set, the Auto Lighting Optimizer can be set ( 137).

Even if I set a decreased exposure compensation, the image comes out bright.

- Set [: **Auto Lighting Optimizer**] to [**Disable**]. When [**Standard**] [**Low**] [**High**] is set, even if you set a decreased exposure compensation or flash exposure compensation, the image may come out bright ( 136).

The built-in flash does not fire.

- If you use the built-in flash too often in too short a period of time, the flash may stop firing for a while to protect the light-emitting unit.

Flash exposure compensation cannot be set for the external Speedlite.

- If flash exposure compensation is set with the external Speedlite, compensation amount cannot be set with the camera. When the external Speedlite's flash exposure compensation is canceled (set to 0), flash exposure compensation can be set with the camera.



The camera makes a noise when it is shaken.

- A small noise may be heard when the camera's internal mechanism moves slightly.

The shutter makes two release sounds during Live View shooting.

- If you use flash, the shutter will make two release sounds each time you shoot (📖182).

During Live View shooting, a white or red icon is displayed.

- It indicates that the camera's internal temperature is high. If the white < > icon is displayed, the still photo's image quality may deteriorate. If the red < > icon is displayed, it indicates that the Live View shooting will soon stop automatically (📖215).

During movie shooting, the red icon is displayed.

- It indicates that the camera's internal temperature is high. If the red < > icon is displayed, it indicates that the movie shooting will soon stop automatically (📖257).

Movie shooting stops by itself.

- If the card's writing speed is slow, movie shooting may stop automatically. For cards that can record movies, see page 7. To find out the card's writing speed, refer to the card manufacturer's Web site, etc.
- If you shoot a movie for 29 min. 59 sec., the movie shooting will stop automatically.

The ISO speed cannot be set for movie shooting.

- In shooting modes other than <M>, the ISO speed is set automatically. In the <M> mode, you can manually set the ISO speed (📖222).

The exposure changes during movie shooting.

- If you change the shutter speed or aperture during movie shooting, the changes in the exposure may be recorded.
- Zooming the lens during movie shooting may cause changes in the exposure regardless of whether the lens's maximum aperture changes or not. The changes in the exposure may be recorded as a result.

The subject looks distorted during movie shooting.

- If you move the camera to the left or right or shoot a moving subject, the image may look distorted.

The image flickers or horizontal stripes appear during movie shooting.

- Flickering, horizontal stripes (noise), or irregular exposures can be caused by fluorescent lighting, LED lighting, or other light sources during movie shooting. Also, changes in the exposure (brightness) or color tone may be recorded. Note that in the <M> mode, a slow shutter speed may reduce the problem.

Problems with Wireless Features

Cannot pair with a smartphone.

- Use a smartphone compliant with Bluetooth Specification Version 4.1 or later.
- Turn on Bluetooth from the smartphone settings screen.
- Pairing with the camera is not possible from the smartphone's Bluetooth settings screen. Install the dedicated app Camera Connect (free of charge) on the smartphone (📖350).
- A previously paired smartphone cannot be paired with the camera again if the camera's registration is retained on the smartphone. In this case, remove the camera's registration retained in the Bluetooth settings on the smartphone and try pairing again (📖357).

Wi-Fi function cannot be set.

- If the camera is connected to a computer or another device with an interface cable, Wi-Fi functions cannot be set. Disconnect the interface cable before setting any functions (📖346).

A device connected with an interface cable cannot be used.

- Other devices, such as computers, cannot be used with the camera by connecting them with an interface cable while the camera is connected to devices via Wi-Fi. Terminate the Wi-Fi connection before connecting the interface cable.

Operations such as shooting and playback are not possible.

- With a Wi-Fi connection established, operations such as shooting and playback may not be possible. Terminate the Wi-Fi connection, then perform the operation.

Cannot reconnect to a smartphone.

- Even with a combination of the same camera and smartphone, if you have changed the settings or selected a different setting, reconnection may not be established even after selecting the same SSID. In this case, delete the camera connection settings from the Wi-Fi settings on the smartphone and set up a connection again.
- A connection may not be established if Camera Connect is running when you reconfigure connection settings. In this case, quit Camera Connect for a moment and then restart it.

Operation Problems

A camera button or dial does not work as expected.

- Under [**☑: Custom Functions(C.Fn)**], check the [**Assign SET button**] setting (📖452).
- For movie shooting, check the [**☑: Shutter btn function for movies**] setting (📖254).

During touch screen operations, the beeper suddenly sounds softer.

- Check if your finger is blocking the speaker (📖28).

Touch operation is not possible.

- Check if [**☑: Touch control**] is set to [**Standard**] or [**Sensitive**] (📖65).

Display Problems

The menu screen shows fewer tabs and options.

- Certain tabs or menu options are not displayed in Basic Zone modes. Set the shooting mode to a Creative Zone mode (📖59).
- Under the [★] tab, [Menu display] is set to [Display only My Menu tab] (📖458).

The file name's first character is an underscore (“_”).

- Set the color space to sRGB. If Adobe RGB is set, the first character will be an underscore (📖145).

The file name starts with “MVI_”.

- It is a movie file (📖267).

The file numbering does not start from 0001.

- If the card already contains recorded images, the image file number may not start from 0001 (📖266).

The shooting date and time displayed are incorrect.

- Make sure the correct date and time are set (📖43).
- Check the time zone and daylight saving time (📖43).

The date and time are not in the image.

- The shooting date and time do not appear in the image. The date and time are recorded in the image data as shooting information. When printing, you can imprint the date and time in the picture, using the date and time recorded in the shooting information (📖316).

[###] is displayed.

- If the number of images recorded on the card exceeds the number the camera can display, [###] will be displayed (📖290).

The LCD monitor does not display a clear image.

- If the LCD monitor is dirty, use a soft cloth to clean it.
- In low or high temperatures, the LCD monitor display may seem slow or may look black. It will return to normal at room temperature.

Playback Problems

Part of the image blinks in black.

- It is the highlight alert (📖327). Overexposed areas with clipped highlights will blink.

The image cannot be erased.

- If the image is protected, it cannot be erased (📖307).

The movie cannot be played back.

- Movies edited with a computer cannot be played back with the camera.

Operation sound and mechanical sound can be heard during movie playback.

- If you operate the camera's dials or lens during movie shooting, the operation sound will also be recorded. Using the Directional Stereo Microphone DM-E1 (sold separately) is recommended (📖251).

The movie appears to freeze momentarily.

- If there is a drastic change in the exposure level during autoexposure movie shooting, the recording will stop momentarily until the brightness stabilizes. In such a case, shoot in the <M> mode (📖221).

No picture appears on the TV set.

- Make sure the [**📺**: **Video system**] is correctly set to [**For NTSC**] or [**For PAL**] (depending on the video system of your TV set).
- Make sure the HDMI cable's plug is inserted all the way in (📖305).

There are multiple movie files for a single movie shoot.

- If the movie file size reaches 4 GB, another movie file will be created automatically (📖229). However, if you use an SDXC card formatted with the camera, you can record a movie in a single file even if it exceeds 4 GB.

My card reader does not recognize the card.

- Depending on the card reader used and the computer's operating system, SDXC cards may not be correctly recognized. In this case, connect your camera to the computer with the interface cable, then import the images to the computer using EOS Utility (EOS software).

The image cannot be resized.

- With this camera, you cannot resize JPEG **S2** or RAW images (📖338).







The image cannot be cropped.

- With this camera, you cannot crop RAW images (📖340).



A red box is displayed on the image.

- [: **AF point disp.**] is set to [**Enable**] (📖323).

A red box is not displayed on the image.



- Even if [: **AF point disp.**] is set to [**Enable**] (📖323), the red box is not displayed for the following images:
 - Images shot with Multi Shot Noise Reduction (📖138)
 - Images shot with <SCN:   > or <    >
 - Cropped images (📖340)
 - Images with Fish-eye effect applied after shooting (📖329)

Dots of light appear on the image.



- White, red, or blue dots of light may appear in captured images if the sensor is affected by cosmic rays or similar factors. Their appearance may be reduced by performing [**Clean now** ] under [: **Sensor cleaning**] (📖273).

Sensor Cleaning Problems

The shutter makes a sound during sensor cleaning.



- When you select **[Clean now **], the shutter will make a mechanical sound, but no picture is taken (273).

Automatic sensor cleaning does not work.

- If you repeatedly turn the power switch <ON> and <OFF> within a short time period, the < > icon may not be displayed (41).

Computer Connection Problems

Communication between the connected camera and computer does not work.

- When using EOS Utility (EOS software), set [: Time-lapse movie] to **[Disable]** (238).

I cannot transfer images to a computer.

- Install EOS software on the computer (482).
- When a Wi-Fi connection is established, the camera cannot be connected to a computer with an interface cable.

Error Codes

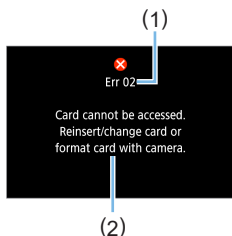

If there is a problem with the camera, an error message will appear. Follow the on-screen instructions.

- (1) Error number
- (2) Cause and countermeasures

Number	Error Message and Solution
01	Communications between the camera and lens is faulty. Clean the lens contacts.
	Clean the electrical contacts on the camera and lens, use a Canon lens, or remove and install the battery again.
02	Card cannot be accessed. Reinsert/change card or format card with the camera.
	Remove and insert the card again, replace the card, or format the card.
04	Cannot save images because card is full. Replace card.
	Replace the card, erase unnecessary images, or format the card.
06	Sensor cleaning could not be performed. Turn the camera off and on again.
	Operate the power switch.
07, 10 20, 30 40, 50 60, 70 80	An error prevented shooting. Turn the camera off and on again or re-install the battery.
	Use the power switch, reinsert the battery pack, or use a Canon lens.

* If the error message still appears after following the above instructions, write down the error code number and contact your nearest Canon Service Center.

Trademarks

- Adobe is a trademark of Adobe Systems Incorporated.
- Microsoft and Windows are trademarks or registered trademarks of Microsoft Corporation in the United States and/or other countries.
- Macintosh and Mac OS are trademarks of Apple Inc., registered in the U.S. and other countries.
- SDXC logo is a trademark of SD-3C, LLC.
- HDMI, HDMI logo, and High-Definition Multimedia Interface are trademarks or registered trademarks of HDMI Licensing LLC.
- WPS used on camera settings screens and in this manual stands for Wi-Fi Protected Setup.
- The Bluetooth® word mark and logos are registered trademarks owned by Bluetooth SIG, Inc. and any use of such marks by Canon Inc. is under license. Other trademarks and trade names are those of their respective owners.
- All other trademarks are the property of their respective owners.

About MPEG-4 Licensing

"This product is licensed under AT&T patents for the MPEG-4 standard and may be used for encoding MPEG-4 compliant video and/or decoding MPEG-4 compliant video that was encoded only (1) for a personal and non-commercial purpose or (2) by a video provider licensed under the AT&T patents to provide MPEG-4 compliant video. No license is granted or implied for any other use for MPEG-4 standard."

* Notice displayed in English as required.

Third party software

This product includes third party software.

- AES-128 Library

Copyright (c) 1998-2008, Brian Gladman, Worcester, UK. All rights reserved.

LICENSE TERMS

The redistribution and use of this software (with or without changes) is allowed without the payment of fees or royalties provided that:

1. source code distributions include the above copyright notice, this list of conditions and the following disclaimer;
2. binary distributions include the above copyright notice, this list of conditions and the following disclaimer in their documentation;
3. the name of the copyright holder is not used to endorse products built using this software without specific written permission.

DISCLAIMER

This software is provided 'as is' with no explicit or implied warranties in respect of its properties, including, but not limited to, correctness and/or fitness for purpose.

Use of Genuine Canon Accessories Is Recommended

This product is designed to achieve optimum performance when used with genuine Canon accessories. Therefore, using this product with genuine accessories is highly recommended.

Canon shall not be liable for any damage to this product and/or accidents such as malfunction, fire, etc. caused by the failure of non-genuine Canon accessories (e.g., a leakage and/or explosion of a battery). Please note that repairs arising out of the malfunction of non-genuine accessories will not be covered by the warranty for repairs, although you may request such repairs on a chargeable basis.



- Battery Pack LP-E17 is dedicated to Canon products only. Using it with an incompatible battery charger or product may result in malfunction or accidents for which Canon cannot be held liable.

Software Start Guide / Downloading Images to a Computer

Software Overview

Downloading and Installing the Software

When using EOS software or other dedicated software, use the latest version available. To download it, you will need to enter the serial number on the bottom of the camera.

- Do not connect the camera to a computer before you install the software. The software will not be installed correctly.
- You cannot install the EOS software to a computer without an Internet connection.
- Previous versions cannot display images from this camera correctly. Also, processing RAW images from this camera is not possible.
- Always update any previous version of the software that is installed (by overwriting it with the latest version).

1 Download the software.

- Connect to the Internet from a computer and access the following Canon Web site.

www.canon.com/icpd

- Select your country or region of residence and download the software.
- Decompress it on the computer.

For Windows: Click the displayed installer file to start the installer.

For Macintosh: A dmg file will be created and displayed. Follow the steps below to start the installer.

- (1) Double-click the dmg file.
 - ➔ A drive icon and installer file will appear on the desktop.
If the installer file does not appear, double-click the drive icon to display it.
- (2) Double-click the installer file.
 - ➔ The installer starts.

2 Follow the on-screen instructions to install.

Downloading and Viewing the Software Instruction Manuals (PDF Files)

Internet connection is required to download the Software Instruction Manuals (PDF files). Download is not possible in environments with no Internet connection.

1 Download the Software Instruction Manuals (PDF files).

- Connect to the Internet and access the following Canon Web site.

www.canon.com/icpd

2 View the Software Instruction Manuals (PDF files).

- Double-click a downloaded Instruction Manual (PDF file) to open it.
- To view the Instruction Manuals (PDF files), Adobe Acrobat Reader DC or other Adobe PDF viewer (most recent version recommended) is required.
- Adobe Acrobat Reader DC can be downloaded for free from the Internet.
- To learn how to use PDF viewing software, refer to the software's Help section.

Downloading Images to a Computer

You can use EOS software to download images from the camera to a computer. There are two ways to do this.

Saving Images to a Connected Computer

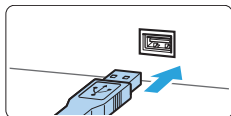
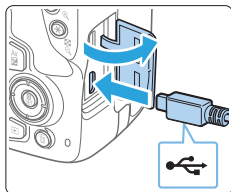

- 1 Install the software (📖482).**
- 2 Use an interface cable (sold separately) to connect the camera to the computer.**
 - Connect the cable to the camera's digital terminal with the cable plug's icon facing the front of the camera.
 - Connect the cord's plug to the computer's USB terminal.
- 3 Use EOS Utility to transfer the images.**
 - Refer to the EOS Utility Instruction Manual.

-  ● When a Wi-Fi connection is established, the camera cannot be connected to a computer with an interface cable.

Downloading Images with a Card Reader

You can use a card reader to download images to a computer.

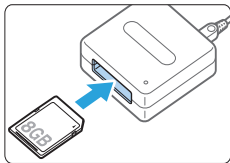

- 1** Install the software (📖 482).
- 2** Insert the card into the card reader.

- 3** Use Digital Photo Professional to download the images.

- Refer to the Digital Photo Professional Instruction Manual.



- When downloading images from the camera to a computer with a card reader without using EOS software, copy the DCIM folder on the card to the computer.

Index

Numbers

1-point AF : 108, 197, 200

[4K] 3840×2160 (Movie) : 228

4K frame capture : 301

9-point AF auto selection : 108

10- or 2-sec. self-timer : 206

1280×720 (Movie) : 228

1920×1080 (Movie) : 228

A

AC adapter : 461

Access lamp : 38

Accessories : 3

Adobe RGB : 145

AEB : 162, 448

AE lock : 164

AF

AF-assist beam : 106, 167

AF method : 197, 252

AF operation : 104, 195

Beep (Beeper) : 260

Continuous AF : 205

Difficult subjects for AF : 110, 202

Eye detection AF : 204

Manual focusing : 111

Out of focus : 49, 110, 202

Recomposing : 74

AF point : 108

AI FOCUS (AI Focus AF) : 106

AI SERVO (AI Servo AF) : 74, 106

Album (video snapshot) : 335

Angle of view : 48

Aperture-priority AE : 152

Art bold effect : 190, 330

<A+> (Scene Intelligent Auto) : 70

Attenuator : 251

Autofocus → AF

Auto Lighting Optimizer : 136

Automatic selection of AF point : 108

Auto playback : 303

Auto power off : 41, 261

Auto reset : 266

Auto rotate : 270

Av (Aperture-priority AE) : 152

B

Background music : 337

Basic Zone modes : 30

Battery : 35, 37, 42

Beep (Beeper) : 260

Black-and-white images : 77

Bluetooth function : 349, 410

Address : 417

Connecting : 351

Bracketing : 134

Built-in flash : 169

BULB (bulb exposure) : 157

Bulb exposure : 157

C

Cables : 305, 484

Camera

Camera vibration blur : 165

Clearing the camera settings to default : 271

Holding the camera : 49

Camera shake : 49

Candlelight : 87

Cards : 7, 26, 37, 66

Formatting : 66

Low-level formatting : 67

Troubleshooting : 38, 67

Write protection : 37

Center-weighted average metering : 159
Charger : 33, 35
Charging : 35
Chromatic aberration correction : 143
Cleaning (image sensor) : 273, 276
Clearing the camera settings to default : 271
Clipped highlights : 327
Close-up : 85
Color space : 145
Color temperature : 129
Color tone : 86, 87, 125
Continuous : 265
Continuous shooting : 112
Contrast : 125
Copyright information : 268
Creative Assist : 76, 332
Creative filters : 93, 188, 235, 329
Creative filters for movies : 235
 Dramatic B&W : 236
 Dream : 236
 Memory : 236
 Miniature effect movie : 237
 Old Movies : 236
Creative Zone modes : 31
Cropping : 340
Custom Functions : 446
Custom white balance : 131

D

Date/time : 43
Daylight saving time : 43
DC coupler : 461
Default settings : 271
Depth-of-field preview : 154
Diffraction correction : 144
Digital Lens Optimizer : 143
Digital terminal : 28
Dioptric adjustment : 49
DISP button : 28, 68, 261, 272

Display level : 51
Distortion correction : 142
DPOF : 316
Dragging : 64
Drive mode : 58, 112
Dust delete data : 274

E

Erasing (images) : 310
Error messages : 477
Evaluative metering : 158
exFAT : 67, 229
Exposure compensation : 160
Exposure level increments : 448
Exposure level indicator : 32
Extension : 267
External flash units → Flash
Eyecup : 28, 464
Eye detection AF : 204

F

Face+Tracking : 197, 198
Feature guide : 55
FEB : 177
FE lock : 173
File name : 265
File size : 324
Filter effect : 123, 126
Fine (Image quality) : 115
First-curtain synchronization : 178
Fish-eye effect : 95, 190, 330
Flash
 Built-in flash : 169
 Custom Functions : 179
 External flash units : 174
 FE lock : 173
 Flash control (function settings) : 175
 Flash exposure compensation : 171
 Flash mode : 177, 178
 Flash off : 175

Manual flash : 178
Shutter synchronization (1st/2nd curtain) : 178
Slow synchro : 176
Flash exposure compensation : 171
Flash mode : 177, 178
Flash sync contacts : 28
Focus indicator : 70
Focusing → AF
Focus lock : 74
Focus mode switch : 47, 111, 212
Folder creation/selection : 263
Food : 86
Formatting : 66
Formatting (card initialization) : 66
Frame Grab : 301
Frame rate : 229
Full High-Definition (Full HD) : 228
Full High-Definition (Full HD) (movie) : 228
Fully-press : 50

G

GPS : 419
Grainy B/W : 95, 190, 330
Grid lines : 194, 254
Group Photo : 81

H

Half-press : 50
Handheld Night Scene : 89
HDMI : 278, 295
HDMI HDR : 279
HD (movie) : 228
HDR art bold : 96
HDR art embossed : 96
HDR art standard : 96
HDR art vivid : 96
HDR Backlight Control : 90
HDR movie : 234

High ISO speed noise reduction : 138
Highlight alert : 327
Highlight tone priority : 137
Histogram (Brightness/RGB) : 327
Hot shoe : 28, 174
Household power : 461

I

ICC profile : 145
Image dust prevention : 273
Image quality : 115
Image review time : 261
Images
 AF point display : 323
 Auto playback : 303
 Auto rotation : 270
 Erasing : 310
 File numbering : 265
 Highlight alert : 327
 Histogram : 327
 Index display : 281
 Jump display (image browsing) : 282
 Magnifying images : 284
 Manual rotation : 287
 Playback : 101, 280
 Protecting : 307
 Rating : 288
 Review time : 261
 Search conditions : 291
 Shooting information : 323
 Slide show : 303
 TV display : 295, 305
Index display : 281
INFO button : 101, 184, 223
IPB (Light) : 229
IPB (Standard) : 229
ISO speed : 118, 219, 222
 Automatic setting (ISO Auto) : 119
 ISO expansion : 448

Maximum limit setting for ISO
Auto : 120
J
JPEG : 115
Jump display : 282
K
Kids : 84
L
Landscape : 82, 122
Language : 46
Large (image quality) : 115, 338
LCD monitor : 26, 40
Angle adjustment : 40, 75
Brightness adjustment : 262
Image playback : 101, 280
Menu display : 59
Lens : 27, 47
Chromatic aberration correction : 143
Diffraction correction : 144
Digital Lens Optimizer : 143
Distortion correction : 142
Lock release : 48
Peripheral illumination correction : 142
Live View shooting : 75, 180
1-point AF : 200
AF operation : 195
Aspect ratio : 192
Creative filters : 188
Eye detection AF : 204
Face+Tracking : 198
Grid lines : 194
Information display : 184
Manual focusing : 212
Metering timer : 193
Quick Control : 187
Self portrait : 210
Spot AF : 200

Zone AF : 200
Location information : 419
Long (bulb) exposures : 157
Long exposure noise reduction : 139
M
Macro photography : 85
Magnifying images : 212, 284
Main dial : 28
Main Dial : 146
Malfunction : 465
Manual exposure : 155, 221
Manual focus : 111, 212
Manual focusing : 111, 212
Manual reset : 267
Manual selection (AF point) : 108
Maximum burst : 116
Medium (image quality) : 115, 338
Memory cards → Cards
Menu : 59
Display level : 51
My Menu : 455
Setting procedure : 60
Menu display : 53
Metering mode : 158
Metering timer : 193, 252
MF (Manual focusing) : 111
MF peaking : 213
Microphone : 218
Miniature effect : 96, 191, 331
Miniature effect movie : 237
Mirror lockup : 165, 449
M (Manual exposure) : 155
Mode dial : 30
Monochrome : 122, 126
Movie digital IS : 232
Movies : 217
AE lock : 164
AF method : 227, 252
Attenuator : 251

Autoexposure : 218
Compression method : 229
Creative filters : 235
Editing : 299
Editing out first and last scenes : 299
Enjoying movies : 295
External microphone : 251
Frame Grab : 301
Frame rate : 229
Grid lines : 254
HDMI output : 278
HDR movie recording : 234
Information display : 223
Manual exposure : 221
Metering timer : 252
Microphone : 218, 251
Movie digital IS : 232
Movie digital zoom : 231
Movie recording size : 228
Movie Servo AF : 253
Playback : 295, 296
Quick Control : 227
Sound recording : 251
Time-lapse movie : 238
Video snapshot : 245
Video snapshot album : 245
Viewing on a TV set : 295, 305
Wind filter : 251
MP4 : 228
Multi shot noise reduction : 138
My Menu : 455

N

Night Portrait : 88
Night scenes : 88, 89
Noise reduction
 High ISO speed : 138
 Long exposure : 139
Normal (Image quality) : 115
NTSC : 229, 305

Number of pixels : 115

O

One-Shot AF : 105, 196

P

PAL : 229
Partial metering : 158
Part names : 28
Peripheral illumination correction : 142
Photobook set-up : 320
Picture Style : 121, 124, 127
Playback : 101, 280
Portrait : 79, 121
Power
 Auto power down : 261
 Battery information : 460
 Battery level : 42, 460
 Charging : 35
 Household power : 461
 Recharge performance : 460

P (Program AE) : 147
Print order (DPOF) : 316
Program AE : 147
Program shift : 148
Protecting images : 307

Q

Quick Control : 57, 99, 187, 227, 293

R

Rating : 288
RAW : 58, 115, 117
RAW+JPEG : 115, 117
Reduced display : 281
Release shutter without card : 260
Remote control shooting : 463
Remote switch : 463
Resizing : 338
Rotating (images) : 270, 287

S

Saturation : 125

Scene icons : 186, 220

Scene Intelligent Auto : 70

SD, SDHC, SDXC cards → Cards

Second-curtain synchronization : 178

Self portrait : 210

Self-timer : 206

Sensitivity → ISO speed

Sensor cleaning : 273, 276

Sepia (Monochrome) : 126

Servo AF

- AI SERVO (AI Servo AF) : 74, 106
- Movie Servo AF : 253
- SERVO (Servo AF) : 196

Sharpness : 125

Shooting information : 323

Shooting mode : 30

- <A+> (Scene Intelligent Auto) : 70
- Av (Aperture-priority AE) : 152
- Creative filters : 93
 - Fish-eye effect : 95
 - Grainy B/W : 95
 - HDR art bold : 96
 - HDR art embossed : 96
 - HDR art standard : 96
 - HDR art vivid : 96
 - Miniature effect : 96
 - Soft focus : 95
 - Toy camera effect : 95
 - Water painting effect : 95
- M (Manual exposure) : 155
- P (Program AE) : 147
- Special scene mode (SCN) : 78
 - Candlelight : 87
 - Close-up : 85
 - Food : 86
 - Group Photo : 81
 - Handheld night scene : 89
 - HDR Backlight Control : 90

Kids : 84

Landscape : 82

Night Portrait : 88

Portrait : 79

Smooth skin : 80

Sports : 83

Tv (Shutter-priority AE) : 149

Shooting mode guide : 54

Shooting screen : 51

Shooting tips : 56

Shutter button : 50

Shutter-priority AE : 149

Shutter synchronization : 178

Single-image display : 101

Single shooting : 112

Slide show : 303

Small (image quality) : 115, 338

Soft focus : 95, 190, 330

Software : 482

Sound-recording level : 251

Speaker : 296

Special scene mode (SCN) : 78

Sports : 83

Spot AF : 197, 200

Spot metering : 158

sRGB : 145

Still img aspect ratio : 192

Strap : 34

T

Temperature warning : 215, 257

Time-lapse movie : 238

Time zone : 43

Tone priority : 137

Toning effect (Monochrome) : 126

Touch beeping : 260

Touch operation : 63

Touch screen : 63, 285

Touch Shutter : 208

Toy camera effect : 95, 190, 331

Tripod socket : 28

Tv (Shutter-priority AE) : 149

U

USB (digital) terminal : 484

UTC (Coordinated Universal Time) : 422

V

Vari-angle LCD monitor : 40, 75

Video snapshot : 245

Video snapshot album : 245

Video system : 228, 305

Viewfinder : 32

 Dioptric adjustment : 49

Viewing on a TV set : 295, 305

Volume (movie playback) : 297, 298

W

Warning icon : 450

Water painting effect : 95, 190, 331

White balance : 129

 Ambience priority (AWB) : 130

 Bracketing : 134, 162

 Correction : 133

 Custom : 131

 White priority (AWB) : 130

White balance (WB) : 129

Wi-Fi features : 344

 Android : 350

 Camera access point mode : 408

 Camera Connect : 350, 355

 CANON iMAGE GATEWAY : 391

 Clearing settings : 425

 Connection history : 413

 Edit device information : 370, 423

 EOS Utility : 374

 Erase connection information : 424

 Image Transfer Utility 2 : 378

 iOS : 350

 IP address : 408

MAC address : 426

Network name : 360, 375, 381

Network settings : 442

Nickname : 424

Notes : 439

PictBridge : 381

Printer : 381

Printing : 383

Print order : 386

Reconnecting : 413

Remote operation : 355

Resize image : 362, 366, 399

Sending all images on
the card : 367, 401

Sending images that match search
conditions : 368, 403

Send selected : 364, 398

SSID : 360, 375, 381

Switch network : 406

Viewable images : 370

View info screen : 426

Viewing images : 355

Virtual keyboard : 427

Wi-Fi settings : 416

WPS (Wi-Fi Protected Setup) : 405

Wind filter : 251

Wireless communication : 344

Z

Zone AF : 197, 200

Canon