

FUJIFILM

DIGITAL CAMERA

X-T3

New Features Guide

Version 5.00





Features added or changed as a result of firmware updates may no longer match the descriptions in the documentation supplied with this product. Visit our website for information on the updates available for different products:













<https://fujifilm-x.com/support/download/firmware/>







Contents

X-T3 firmware version 5.00 adds or updates the features listed below. For information on earlier versions, visit the following website.

<http://fujifilm-dsc.com/en/manual/>

No.	Description	X-T3 	See 	Ver.
1	The chosen value is now displayed when a color temperature is selected for white balance.	10, 12	1, 2	2.00
2	The camera now displays a “charging” icon when powered via USB or by the AC-9VS AC adapter supplied with the VG-XT3 vertical battery grip.	10, 12	1, 2	2.00
3	Touch zoom is now available with compatible lenses. A TOUCH ZOOM option has consequently been added to  BUTTON/DIAL SETTING > TOUCH SCREEN SETTING in the setup menu.	24, 211	3, 23	4.40
4	In focus mode C (AF-C), users can now refocus during movie recording by pressing the shutter button halfway or by pressing the button to which AF-ON is assigned.	54	4	4.00
5	Focus-point selection is now available while AE lock is in effect.	82	5	4.00
6	Changes have been made to the  AF/MF SETTING > FACE/EYE DETECTION SETTING item in the shooting menu.	121	6	3.00
7	Improved the performance of  AF/MF SETTING > FACE/EYE DETECTION SETTING in the shooting menu.	121	6, 20	4.00
8	The default for  AF/MF SETTING > RELEASE/ FOCUS PRIORITY > AF-S PRIORITY SELECTION in the shooting menu has changed from RELEASE to FOCUS .	125	8	4.00
9	An AF RANGE LIMITER option has been added to the  AF/MF SETTING item in the shooting menu.	125	8	4.00
10	Changes have been made to the  SHOOTING SETTING > FLICKER REDUCTION item in the shooting menu.	136	9	3.00
11	The  MOVIE SETTING > F-Log RECORDING item in the shooting menu has been renamed F-Log/HLG RECORDING .	149	10	2.00

No.	Description	X-T3 	See 	Ver.
12	The procedure for rating pictures has changed. As a result, the content of the playback information displays has changed and a RATING item has been added to the playback menu.	160, 161, 175	11, 12, 13	4.00
13	Movies over 4 GB in size are now recorded to a single file.	176, 261, 295	14	2.10
14	An  AREA SETTING option has been added under  USER SETTING in the setup menu, resulting in a change to the basic setup procedure and adjustments to TIME DIFFERENCE . In addition, DATE/TIME now offers a 24-hour clock.	187	15	5.00
15	The items listed in the setup menu under  USER SETTING > RESET have changed.	189	16	5.00
16	The  CONNECTION SETTING > Bluetooth SETTINGS item in the setup menu has been renamed Bluetooth/SMARTPHONE SETTING and now offers an IMAGE TRANSFER WHILE POWER OFF option. In addition, AUTO IMAGE TRANSFER and SMARTPHONE SYNC. SETTING have respectively been renamed AUTO IMAGE TRANSFER ORDER and SMARTPHONE LOCATION SYNC .	216	24	5.00
17	Upload timing has changed. Pictures can now be uploaded not only during playback or when the camera is off but also while shooting is in progress.	216	24	5.00
18	 CONNECTION SETTING > GENERAL SETTINGS has been reorganized as follows: <ul style="list-style-type: none"> • LOCATION INFO has been moved to  SCREEN SET-UP, •  BUTTON SETTING has been moved to  BUTTON/DIAL SETTING and renamed  Fn1 BUTTON SETTING, • GEOTAGGING has been moved to  SAVE DATA SET-UP, and • NAME and RESIZE IMAGE FOR SMARTPHONE  have been moved to Bluetooth/SMARTPHONE SETTING. 	201, 210, 215, 216	16, 17, 24	5.00

No.	Description	X-T3 	See 	Ver.
19	The procedure for connecting wirelessly to smartphones has changed.	254	31	5.00
20	The roles that can be assigned to the function buttons have changed.	204, 228	18	3.00
21	Digital zoom lenses equipped with lens function buttons are now supported. A POWER ZOOM LENS FUNCTION (Fn) SETTING option has consequently been added to  BUTTON/DIAL SETTING in the setup menu. In addition, the roles that can be assigned to the function buttons have changed.	204, 205, 228, 229, 249	18, 20, 28, 30	4.40
22	A LENS ZOOM/FOCUS SETTING item has been added to  BUTTON/DIAL SETTING in the setup menu to control the behavior of digital zoom lenses equipped with lens function buttons.	209	21	4.40
23	FOCUS RING has consequently been renamed FOCUS RING ROTATE and has, together with FOCUS RING OPERATION , been moved to LENS ZOOM/FOCUS SETTING .	209	21	4.40
24	Changes have been made to the  BUTTON/DIAL SETTING > TOUCH SCREEN SETTING item in the setup menu.	211	23	3.00
25	A Bluetooth DEVICE LIST item has been added to  CONNECTION SETTING > Bluetooth SETTINGS in the setup menu.	216	24	4.50
26	The  CONNECTION SETTING > PC CONNECTION MODE item in the setup menu has been renamed CONNECTION MODE .	218	26	3.10
27	The TG-BT1 tripod grip has been added to the optional accessory list.	266	35	4.50

Changes and Additions

Changes and additions are as follows.

X-T3 Owner's Manual:  10

Ver. 2.00

The Electronic Viewfinder

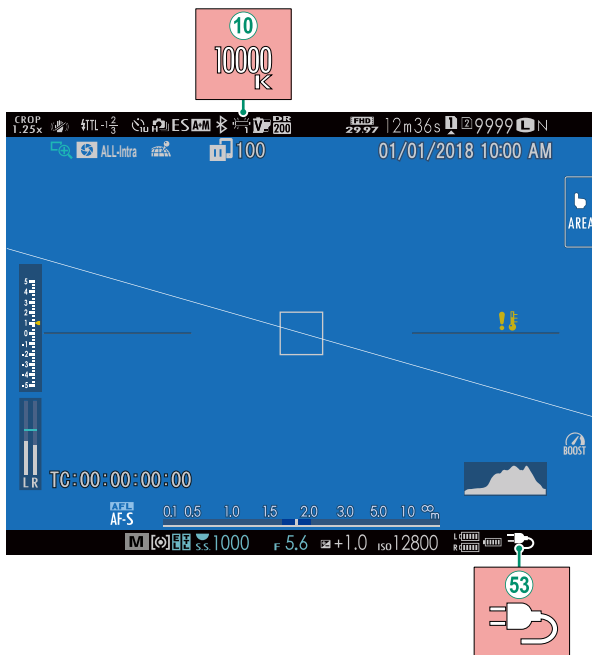

- ⑩ When a color temperature is selected for white balance (*X-T3 Owner's Manual*  108), the chosen value now appears in the display.
- ⑤③ The camera now displays a “charging” icon when powered via USB or by the AC-9VS AC adapter supplied with the VG-XT3 vertical battery grip.

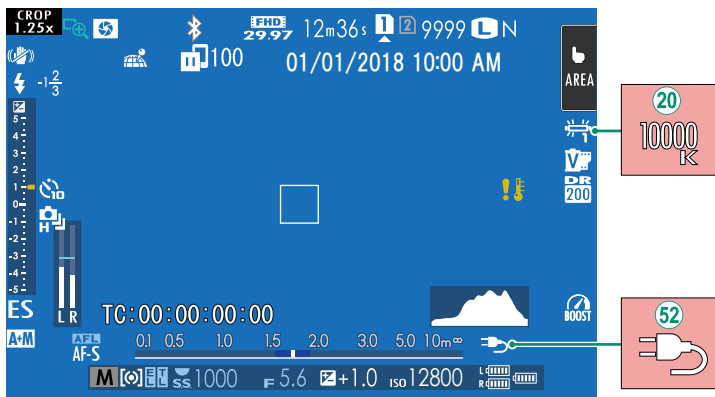

- ②0 When a color temperature is selected for white balance (*X-T3 Owner's Manual* 108), the chosen value now appears in the display.
- ⑤2 The camera now displays a “charging” icon when powered via USB or by the AC-9VS AC adapter supplied with the VG-XT3 vertical battery grip.



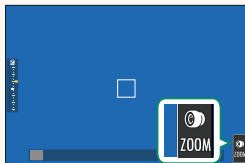

Touch Zoom

If the lens supports touch zoom, you can zoom in and out by touching the display. Tap the touch zoom button in the display to enable touch zoom.

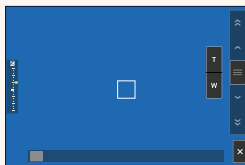







Touch zoom is controlled using the buttons in the display.



Button	Description
 Touch zoom	Enable touch zoom.
 Zoom in	Zoom in or out. Touch and hold to zoom in or out at a constant speed.
 Zoom out	
 Rocker switch	Swipe to choose a zoom position. Touch and hold to zoom in or out at a speed corresponding where you put your finger.
 Disable	Disable touch zoom.

Adjusting Movie Settings

-  • The indicator lamp lights while recording is in progress (the  **MOVIE SETTING** > **TALLY LIGHT** option can be used to choose the lamp—indicator or AF-assist—that lights during movie recording and whether the lamp blinks or remains steady). During recording, you can change exposure compensation by up to ± 2 EV and adjust zoom using the zoom ring on the lens (if available).
- If the lens is equipped with an aperture mode switch, select the aperture mode before beginning recording. If an option other than **A** is selected, shutter speed and aperture can be adjusted while recording is in progress.
- While recording is in progress, you can:
 - Adjust sensitivity
 - Use the **VIEW MODE** button and the eye sensor to switch between the EVF and LCD monitor displays
 - Refocus using any of the following methods:
 - Press the shutter button halfway
 - Press a function button to which **AF-ON** is assigned
 - Use touch screen controls
 - Display a histogram or artificial horizon by pressing the button to which **HISTOGRAM** or **ELECTRONIC LEVEL** has been assigned
- Recording may be unavailable at some settings, while in other cases settings may not apply during recording.
- The slot to which movies are recorded can be selected using the  **SAVE DATA SET-UP** > **SELECT SLOT**( **SEQUENTIAL**) option in the  (setup) menu.
- To choose the focus area for movie recording, select  **MOVIE SETTING** >  **FOCUS AREA** and use the focus stick (focus lever) and rear command dial.
- In focus mode **C** (AF-C), the camera can be refocused during movie recording by pressing the shutter button halfway or by pressing the button to which **AF-ON** is assigned.

Focus/Exposure Lock

Compose photographs with off-center subjects.

- 1 Position the subject in the focus frame and press the shutter button halfway to lock focus and exposure. Focus and exposure will remain locked while the shutter button is pressed halfway (AF/AE lock).

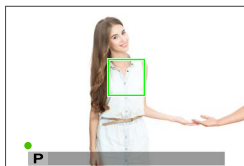

- 2 Keep the shutter button pressed halfway.

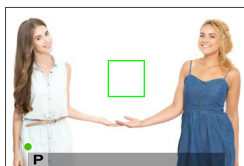

- 3 Press the button all the way down.



- Focus lock using the shutter button is only available when **ON** is selected for **BUTTON/DIAL SETTING > SHUTTER AF, SHUTTER AE**.
- The focus lever (focus stick) can be used to reposition the focus point during exposure lock.

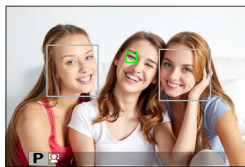

Intelligent Face Detection sets focus and exposure for human faces anywhere in the frame, preventing the camera from focusing on the background in group portraits. Choose for shots that emphasize portrait subjects. You can also choose whether the camera detects and focuses on either the left or right eye when Intelligent Face Detection is on.



Option	Description
FACE DETECTION ON	Adjust settings for Intelligent Face Detection. You can also adjust eye detection settings. <ul style="list-style-type: none">• EYE OFF: Intelligent Face Detection only.• EYE AUTO: The camera automatically chooses which eye to focus on when a face is detected.• RIGHT EYE PRIORITY: The camera focuses on the right eye of subjects detected using Intelligent Face Detection.• LEFT EYE PRIORITY: The camera focuses on the left eye of subjects detected using Intelligent Face Detection.
OFF	Intelligent Face Detection and eye priority off.

- If the subject moves as the shutter button is pressed, the face may not be in the area indicated by the green border when the picture is taken.
- In some modes, the camera may set exposure for the frame as a whole rather than the portrait subject.



- The face selected by the camera is indicated by a green border. Any other faces detected by the camera are indicated by gray borders. To have the camera focus on a different subject, tap inside the gray border. The  icon will change from white to green.
- You can also switch subjects by pressing the function button to which **FACE SELECT**  is assigned and then using the focus stick (focus lever) or (during viewfinder photography) touch controls ( 20).
- To switch from face detection to manual focus-area selection, press the center of the focus stick (focus lever). Press again to re-enable face detection.
- If the selected subject leaves the frame, the camera will wait a set time for its return and consequently the green frame may sometimes appear in locations where no face is seen.
- You cannot switch subjects during burst photography.
- Depending on shooting conditions, face selection may be suspended at the close of burst shooting.
- Faces can be detected with the camera in vertical or horizontal orientation.
- If the camera is unable to detect the subject's eyes because they are hidden by hair, glasses, or other objects, the camera will instead focus on faces.
- Face/eye detection options can also be accessed via shortcuts.

RELEASE/FOCUS PRIORITY

Choose how the camera focuses in focus mode **AF-S** or **AF-C**.

Option	Description
RELEASE	Shutter response is prioritized over focus. Pictures can be taken when the camera is not in focus.
FOCUS	Focus is prioritized over shutter response. Pictures can be only taken when the camera is in focus.

 From firmware version 4.00, the default for **AF-S PRIORITY SELECTION** has changed to **FOCUS**.

AF RANGE LIMITER

Limit the range of available focus distances for increased focus speed.

Option	Description
OFF	Focus limiter disabled.
CUSTOM	Limit focus to a range of distances defined by a minimum and maximum. <ul style="list-style-type: none"> • OK: Limit focus to the selected range. • SET: Choose two objects and limit focus to the distance between them.
PRESET1 PRESET2	Limit focus to a preset range.

 • Choosing a focus range that includes distances shorter than the minimum focus distance of the lens disables the focus limiter.

• The values listed and displayed for the focus limiter may differ from the actual focus distance.

 The following additional operations can be performed when **CUSTOM** is selected:

- You can tap objects in the touch screen display to choose the focus range.
- Instead of tapping an object in the display, you set the maximum focus distance to infinity by rotating the focus ring.

FLICKER REDUCTION















Reduce flicker in pictures and the display when shooting under fluorescent lighting and other similar light sources.













Option	Description
ALL FRAMES	Flicker reduction is applied to all frames continuous shooting frame rate reduces.
FIRST FRAME	Flicker measurement is taken prior to the first frame only and the same reduction amount is applied to all subsequent frames that flicker may occur.
OFF	Flicker reduction disabled.

-  • Flicker reduction increases the time needed to record pictures.
- **OFF** is selected for **FLICKER REDUCTION** when the electronic shutter is used.
- Flicker reduction is not available during movie recording.

F-Log/HLG RECORDING

Choose the destination for F-Log and HLG (Hybrid Log-Gamma) movies shot while the camera is connected to an HDMI device.

Option	Description
   	The footage is processed using film simulation and both saved to the memory card and output to the HDMI device.
 F-Log  F-Log	The footage is recorded to the memory card and output to the HDMI device in F-Log format.
   F-Log	The footage is output to the HDMI device in F-Log format but saved to the memory card with film simulation applied.
 F-Log  	The footage is recorded to the memory card in F-Log format but output to the HDMI device with film simulation applied.
 HLG  HLG	The footage is recorded to the memory card and output to the HDMI device in HLG format.

-  • F-Log offers a gentle gamma curve with a wide gamut suitable for further processing post-production. Sensitivity is restricted to values between ISO 640 and ISO 12800.
- The **HLG** (Hybrid Log-Gamma) recording format conforms to the international ITU-R BT2100 standard. When viewed on HLG-compatible displays, high-quality HLG footage faithfully captures high-contrast scenes and vivid colors. Sensitivity is restricted to values between ISO 1000 and ISO 12800. HLG recording is available when **H.265 (HEVC)** is selected for  **MOVIE SETTING** > **H.265 (HEVC)/H.264** in the shooting menu.
- Film simulation () footage is recorded using the option selected for  **MOVIE SETTING** >  **FILM SIMULATION** in the shooting menu.
- Footage shot with    **F-Log** or  **F-Log**   cannot be recorded to the memory card and output to the HDMI at different frame sizes (4K, Full HD). In addition, the following  **MOVIE SETTING** options are unavailable:
 - **MOVIE MODE** frame rate options of **59.94P** and **50P**
 - **FULL HD HIGH SPEED REC**
 - **4K INTERFRAME NR**
 - **HDMI OUTPUT INFO DISPLAY**

The Playback Display

This section lists the indicators that may be displayed during playback.

For illustrative purposes, displays are shown with all indicators lit.

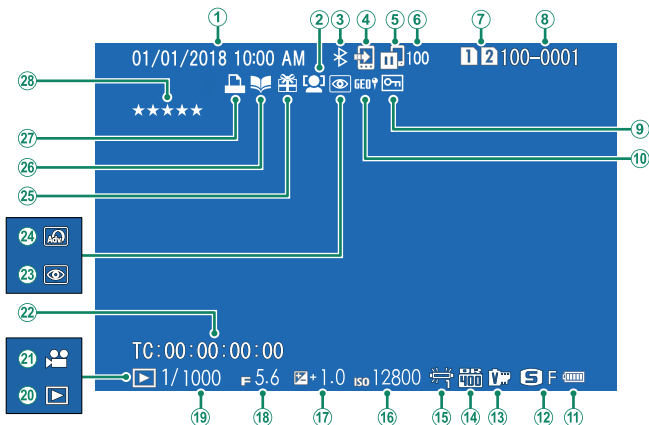

- | | |
|--|------------------------------|
| ① Date and time | ⑮ White balance |
| ② Face detection indicator | ⑯ Sensitivity |
| ③ Bluetooth ON/OFF | ⑰ Exposure compensation |
| ④ Image transfer order | ⑱ Aperture |
| ⑤ Image transfer status | ⑲ Shutter speed |
| ⑥ Number of frames selected for upload | ⑳ Playback mode indicator |
| ⑦ Card slot | ㉑ Movie icon |
| ⑧ Frame number | ㉒ Time code |
| ⑨ Protected image | ㉓ Red-eye removal indicator |
| ⑩ Location data | ㉔ Advanced filter |
| ⑪ Battery level | ㉕ Gift image |
| ⑫ Image size/quality | ㉖ Photobook assist indicator |
| ⑬ Film simulation | ㉗ DPOF print indicator |
| ⑭ Dynamic range | ㉘ Rating..... 13 |

The **DISP/BACK** button controls the display of indicators during playback.

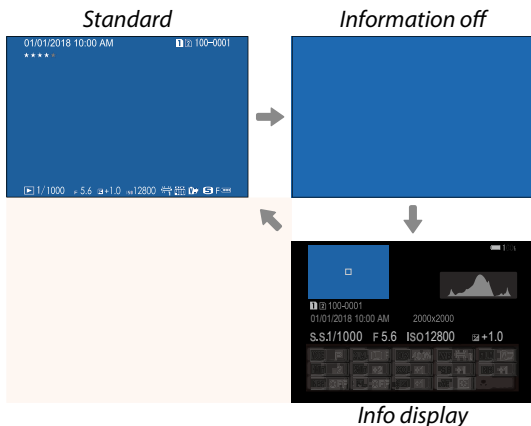
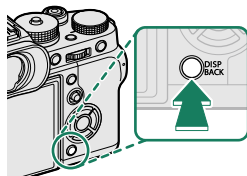

Favorites: Rating Pictures

Pictures can be rated via the **RATING** item in the playback menu.

RATING

Rate pictures using stars.

- 1 Select **RATING** in the playback menu.
- 2 Rotate the front command dial to choose a picture and the rear command dial to choose a rating of from 0 to 5 stars ("★").



- The selector can be used in place of the front command dial to choose a picture.
- The rating dialog can also be displayed by pressing the **AE-L** button in single-frame, nine-frame, or hundred-frame playback.
- Use touch controls to zoom in or out.

X-T3 Owner's Manual: 176

COPY

Ver. 2.10

-  • Copying ends when the destination is full.
- If you attempt to copy a file over 4 GB in size to a memory card with a capacity of 32 GB or less, copying will end and the file will not be copied.

X-T3 Owner's Manual: 261

Mac OS X/macOS

Ver. 2.10

Pictures can be copied to your computer using Image Capture (supplied with your computer) or other software.

-  Use a card reader to copy files over 4 GB in size.

X-T3 Owner's Manual: 295

Memory Card Capacity

Ver. 2.10

-  If the memory card has a capacity of over 32 GB, movies will be recorded in single files, regardless of size. If the card has a capacity of 32 GB or less, movies over 4 GB in size will be recorded uninterrupted across multiple files.

 **AREA SETTING**

Adjust settings for your current time zone.

AREA SETTING

Choose your time zone from a map.



DAYLIGHT SAVINGS

Turn daylight saving time on or off.

Option	Description
ON	Daylight saving time on.
OFF	Daylight saving time off.



TIME DIFFERENCE



Switch the camera clock instantly from your home time zone to the local time at your destination when traveling. To specify the difference between your local and home time zone:



 Use  **AREA SETTING** to choose your home time zone before selecting a local time zone using  **LOCAL**.

- 1 Highlight  **LOCAL** and press **MENU/OK**.
- 2 Use the selector to choose the local time zone. Press **MENU/OK** when settings are complete.

 Select **ON** to enable daylight saving time.

To set the camera clock to local time, highlight  **LOCAL** and press **MENU/OK**. To set the clock to the time in your home time zone, select  **HOME**.

Options	
 LOCAL	 HOME

 If  **LOCAL** is selected,  will be displayed in yellow for about three seconds when the camera is turned on.

RESET

Reset shooting or setup menu options to default values.

- 1 Highlight the desired option and press **MENU/OK**.

Option	Description
SHOOTING MENU RESET	Reset all shooting menu settings other than custom white balance and custom settings banks created using EDIT/SAVE CUSTOM SETTING to default values.
SET-UP RESET	Reset all setup menu settings other than DATE/TIME ,  AREA SETTING , TIME DIFFERENCE , and COPYRIGHT INFO to default values.
INITIALIZE	Reset all settings other than custom white balance to default values.

- 2 A confirmation dialog will be displayed; highlight **OK** and press **MENU/OK**.



LOCATION INFO

Select **ON** to display location info downloaded from a smart-phone.

Options	
ON	OFF

 **Fn1 BUTTON SETTING**

Choose the role performed by the **Fn1** button during playback.

Option	Description
 SMARTPHONE TRANSFER ORDER	Pressing the button marks the current picture for transfer. If the camera is not currently paired with a smartphone, Bluetooth/SMARTPHONE SETTING options will be displayed.
 SELECT & SMARTPHONE TRANSFER ORDER	Pressing the button displays a dialog where pictures can be selected for upload to a smartphone with which the camera is paired. If the camera is not currently paired with a smartphone, Bluetooth/SMARTPHONE SETTING options will be displayed instead.
 WIRELESS COMMUNICATION	The button can be used for wireless connections.

GEOTAGGING

If **ON** is selected, location data downloaded from a smartphone will be embedded in pictures as they are taken.

Options	
ON	OFF

FUNCTION (Fn) SETTING

Choose the roles played by the function buttons.

- 1 Select  **BUTTON/DIAL SETTING** > **FUNCTION (Fn) SETTING** in the  **(SET UP)** tab.
- 2 Highlight the desired control and press **MENU/OK**.
- 3 Highlight any of the following options and press **MENU/OK** to assign it to the selected control.
 - IMAGE SIZE
 - IMAGE QUALITY
 - RAW
 - FILM SIMULATION
 - GRAIN EFFECT
 - COLOR CHROME EFFECT
 - DYNAMIC RANGE
 - D RANGE PRIORITY
 - WHITE BALANCE
 - SELECT CUSTOM SETTING
 - FOCUS AREA
 - FOCUS CHECK
 - AF MODE
 - AF-C CUSTOM SETTINGS
 - FACE SELECT  
 - FACE DETECTION ON/OFF
 - AF RANGE LIMITER
 - DRIVE SETTING
 - SPORTS FINDER MODE
 - PRE-SHOT **ES** 
 - SELF-TIMER
 - SHUTTER TYPE
 - FLICKER REDUCTION
 - ISO AUTO SETTING
 - IS MODE
 - WIRELESS COMMUNICATION
 - FLASH FUNCTION SETTING
 - TTL-LOCK
 - MODELING FLASH
 - FULL HD HIGH SPEED REC
 - ZEBRA SETTING
 - INTERNAL/EXTERNAL MIC LEVEL ADJUSTMENT
 - MOVIE SILENT CONTROL
 - PREVIEW DEPTH OF FIELD
 - PREVIEW EXP/WB IN MANUAL MODE
 - NATURAL LIVE VIEW
 - HISTOGRAM
 - ELECTRONIC LEVEL
 - LARGE INDICATORS MODE
 - ZOOM/FOCUS CONTROL RING
 - CONSTANT SPEED ZOOM (T)
 - CONSTANT SPEED ZOOM (W)
 - **MF** CONSTANT SPEED FOCUS (N)
 - **MF** CONSTANT SPEED FOCUS (F)
 - AE LOCK ONLY
 - AF LOCK ONLY
 - AE/AF LOCK
 - AF-ON
 - AWB LOCK ONLY
 - APERTURE SETTING
 - PERFORMANCE
 - AUTO IMAGE TRANSFER
 - SELECT PAIRING DESTINATION







- Bluetooth ON/OFF
- PLAYBACK
- NONE (control disabled)





The following cannot be assigned to the touch function buttons (**T-Fn1** through **T-Fn4**).

- **CONSTANT SPEED ZOOM (T)**
 - **CONSTANT SPEED ZOOM (W)**
 - **MF CONSTANT SPEED FOCUS (N)**
 - **MF CONSTANT SPEED FOCUS (F)**
 - **AE LOCK ONLY**
 - **AF LOCK ONLY**
 - **AE/AF LOCK**
 - **AF-ON**
 - **AWB LOCK ONLY**
- The selector cannot be assigned more than one role at a time.
 - Function button assignment options can also be accessed by holding the **DISP/BACK** button.

FACE SELECT

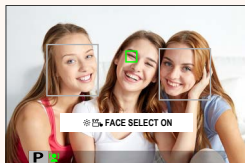
FACE SELECT   can be enabled or disabled by pressing the button to which **FACE SELECT**   is assigned. Enabling **FACE SELECT**   allows the focus stick (focus lever) or (during viewfinder photography) touch controls to be used to select the face that will be used for focus.



The following features can be accessed using the focus stick or during viewfinder photography when **FACE SELECT**   is enabled:

- The face used to set focus can be selected using the focus stick. To switch from face detection to manual focus-area selection, press the center of the focus stick (focus lever). Press again to re-enable face detection.
- The touch screen (monitor) or focus stick can be used to select the face used to set focus during viewfinder photography.

X-T3 Owner's Manual:  205

Ver. 4.40

POWER ZOOM LENS FUNCTION (Fn) SETTING

Choose the roles played by the function buttons available on some power zoom lenses.

LENS ZOOM/FOCUS SETTING

Adjust settings for compatible lenses with focus rings or power zoom.

FOCUS RING ROTATE

Choose the direction in which the focus ring is rotated to increase the focus distance.

Options
 **CW** (clockwise)

 **CCW** (counterclockwise)
FOCUS RING OPERATION

Choose how the camera adjusts focus in response to the movement of the focus ring.

Option	Description
NONLINEAR	Focus is adjusted at the same rate as the ring is rotated.
LINEAR	Focus is adjusted linearly according to the amount the ring is rotated, but the focusing speed is unaffected by the speed the ring is rotated.

MF CONSTANT SPEED FOCUS (Fn)

Choose the rate at which the focus distance changes when adjusted using function buttons during manual focus with compatible power zoom lenses. The higher the number, the higher the rate.

Options

1(SLOW)	2	3	4	5	6	7	8(FAST)
----------------	----------	----------	----------	----------	----------	----------	----------------

CONSTANT SPEED ZOOM (Fn)

Choose the rate at which compatible power zoom lenses can be zoomed in or out using function buttons. The higher the number, the higher the rate.

Options

1(SLOW)	2	3	4	5	6	7	8(FAST)
----------------	----------	----------	----------	----------	----------	----------	----------------

CONSTANT SPEED ZOOM/FOCUS (Fn) OPERATION

Choose whether the function buttons on compatible power zoom lenses need only be pressed once to start and stop power focus or power zoom.

Option	Description
START/STOP SWITCH	The operation starts when the button is pressed and stops when it is pressed a second time.
ACTIVE WHILE PRESSING	The operation continues while the button is pressed and stops when the button is released.

ZOOM RING ROTATE

Choose whether to reverse the rotation of the zoom ring on compatible power zoom lenses.

Options	
 CW (clockwise)	 CCW (counterclockwise)

























ZOOM/FOCUS CONTROL RING

Choose role played by the zoom/focus control ring on compatible power zoom lenses.

Options	
ZOOM	FOCUS

TOUCH SCREEN SETTING

Enable or disable touch-screen controls.

Option	Description								
 TOUCH SCREEN SETTING	<ul style="list-style-type: none"> • ON: The LCD monitor functions as a touch screen during shooting. • OFF: Touch controls disabled. 								
 DOUBLE TAP SETTING	<ul style="list-style-type: none"> • ON: Tap the LCD monitor twice to zoom in on your subject during shooting. • OFF: Touch zoom disabled. 								
 TOUCH FUNCTION	<p>Enable or disable touch function gestures.</p>								
TOUCH ZOOM	<ul style="list-style-type: none"> • ON: If the lens supports touch zoom, you can zoom in and out by touching the LCD monitor. • OFF: Touch zoom disabled. 								
 TOUCH SCREEN SETTING	<ul style="list-style-type: none"> • ON: The LCD monitor functions as a touch screen during playback. • OFF: Touch controls disabled. 								
EVF TOUCH SCREEN AREA SETTINGS	<p>Select the area of the LCD monitor used for touch controls while the viewfinder is active.</p> <ul style="list-style-type: none"> • The area used for touch controls can be selected from: <table border="0" data-bbox="319 856 864 987"> <tr> <td>-  (all)</td> <td>-  (left half)</td> </tr> <tr> <td>-  (right half)</td> <td>-  (top left quarter)</td> </tr> <tr> <td>-  (top right quarter)</td> <td>-  (bottom left quarter)</td> </tr> <tr> <td>-  (bottom right quarter)</td> <td></td> </tr> </table> • Choose OFF to disable touch controls while the viewfinder is active. 	-  (all)	-  (left half)	-  (right half)	-  (top left quarter)	-  (top right quarter)	-  (bottom left quarter)	-  (bottom right quarter)	
-  (all)	-  (left half)								
-  (right half)	-  (top left quarter)								
-  (top right quarter)	-  (bottom left quarter)								
-  (bottom right quarter)									

Bluetooth/SMARTPHONE SETTING

Adjust Bluetooth settings.

Option	Description
PAIRING REGISTRATION	Pair the camera with a smartphone or tablet to which the smartphone app has been installed.
SELECT PAIRING DESTINATION	Choose a connection from a list of devices with which the camera has been paired using PAIRING REGISTRATION . Select NO CONNECTION to exit without connecting.
DELETE PAIRING REG.	Delete pairing information for selected devices. Choose the device in the device list. The selected device will also be removed from the devices listed in SELECT PAIRING DESTINATION .
Bluetooth DEVICE LIST	List the devices with which the camera is paired (other than the smartphone) or end pairing with selected devices.
Bluetooth ON/OFF	<ul style="list-style-type: none"> • ON: The camera automatically establishes a Bluetooth connection with paired devices when turned on. • OFF: The camera does not connect via Bluetooth.
AUTO IMAGE TRANSFER ORDER	Choose whether pictures are automatically marked for upload as they are taken.
SMARTPHONE LOCATION SYNC.	Choose whether to synchronize the camera to the location provided by a paired smartphone.
NAME	Choose a name (NAME) to identify the camera on the wireless network (the camera is assigned a unique name by default).
IMAGE TRANSFER WHILE POWER OFF	Choose whether the camera uploads pictures to paired smartphones while off.
RESIZE IMAGE FOR SMARTPHONE 	<p>Choose whether to resize images for upload to smartphones. Resizing applies only to the copy uploaded to the smartphone; the original is not affected.</p> <ul style="list-style-type: none"> • ON: Larger images are resized to 3M for upload. • OFF: Images are uploaded at their original size.



- Be sure your smartphone is running the latest version of the applicable smartphone app. Different operating systems use different apps; for more information, visit:
<https://app.fujifilm-dsc.com/>
- Pictures will be uploaded during shooting and playback and while the camera is off if **ON** is selected for both **Bluetooth ON/OFF** and **AUTO IMAGE TRANSFER ORDER** or if images are currently selected for upload using the **IMAGE TRANSFER ORDER** option in the playback menu.
- The camera clock will automatically be set to the time reported by paired smartphones whenever the app is launched.

CONNECTION MODE

Adjust settings for connection to external devices.

Option	Description
USB CARD READER	Connecting the camera to a computer via USB automatically enables data transfer mode, allowing data to be copied to the computer. The camera functions normally when not connected.
USB TETHER SHOOTING AUTO	<p>The camera can be controlled from computers, gimbals, drones, or other devices connected via USB. The camera automatically enters “tethered shooting” (i.e., remote-control) mode when the external device is turned on and returns to normal operation when the external device turned off or disconnected.</p> <ul style="list-style-type: none"> • Photographs can be taken remotely and automatically downloaded to computers running Capture One, Adobe® Photoshop® Lightroom® + Tether Plugin, or FUJIFILM X Acquire. FUJIFILM X Acquire can also be used to save and load camera settings. • Remote photography and movie recording are available when the camera is connected to a compatible device such as a gimbal or drone. Use the camera mode dial to switch between still photography and movie recording. The features available vary with the device connected.
USB TETHER SHOOTING FIXED	As for USB TETHER SHOOTING AUTO , except that the camera remains in “tethered shooting” (remote-control) mode when the external device is off or not connected, allowing the device to resume control when the connection is re-established after an accidental disconnection or other disruption. At default settings, pictures are not recorded to the memory card.
WIRELESS TETHER SHOOTING FIXED	Choose this option for wireless remote photography. Select a network using  CONNECTION SETTING > NETWORK SETTING.

Option	Description
USB RAW CONV./ BACKUP RESTORE	<p>Connecting the camera to a computer via USB automatically enables USB RAW conversion/backup restore mode. The camera functions normally when not connected.</p> <ul style="list-style-type: none"> • USB RAW CONV. (requires FUJIFILM X RAW STUDIO): Use the camera's image processing engine to rapidly convert RAW files to high-quality JPEG images. • BACKUP RESTORE (requires FUJIFILM X Acquire): Save and load camera settings. Reconfigure the camera in an instant or share settings with other cameras of the same type.

 **POWER MANAGEMENT > AUTO POWER OFF** settings also apply during tethered shooting. To prevent the camera turning off automatically, select **OFF** for **AUTO POWER OFF**.

 Visit the websites below to learn more about or download the following computer software:

- **Capture One Express Fujifilm:**
<https://www.captureone.com/products-plans/capture-one-express/fujifilm>
- **Capture One Pro Fujifilm:**
<https://www.captureone.com/explore-features/fujifilm>
- **Adobe® Photoshop® Lightroom® + Tether Plugin:**
<https://fujifilm-x.com/global/products/software/adobe-photoshop-lightroom-tether-plugin/>
- **FUJIFILM X Acquire:**
<https://fujifilm-x.com/products/software/x-acquire/>
- **FUJIFILM X RAW STUDIO:**
<https://fujifilm-x.com/products/software/x-raw-studio/>
- **RAW FILE CONVERTER EX powered by SILKYPPIX:**
<https://fujifilm-x.com/support/download/software/raw-file-converter-ex-powered-by-silkypix/>

Lens Function Buttons

Choose the roles played by the function buttons on the lens (where applicable).

Lens Function Button Defaults

The default assignments are:

 A XF18-120mmF4 LM PZ WR lens is used here for illustrative purposes.

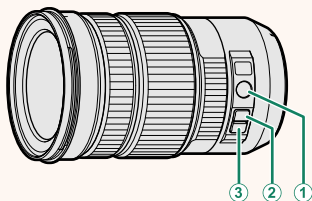

Lens function button	Default
① Z/F	ZOOM/FOCUS CONTROL RING
② L-Fn1 (rocker zoom button pressed up)	CONSTANT SPEED ZOOM (T)
③ L-Fn2 (rocker zoom button pressed down)	CONSTANT SPEED ZOOM (W)

Assigning Roles to the Lens Function Buttons

The roles played by the lens function buttons can be selected using the **FUNCTION/DIAL SETTING > POWER ZOOM LENS FUNCTION (Fn) SETTING** option in the setup menu.

- IMAGE SIZE
- IMAGE QUALITY
- RAW
- FILM SIMULATION
- GRAIN EFFECT
- COLOR CHROME EFFECT
- DYNAMIC RANGE
- D RANGE PRIORITY
- WHITE BALANCE
- SELECT CUSTOM SETTING
- FOCUS AREA
- FOCUS CHECK
- AF MODE
- AF-C CUSTOM SETTINGS
- FACE SELECT 
- FACE DETECTION ON/OFF
- AF RANGE LIMITER
- DRIVE SETTING
- SPORTS FINDER MODE
- PRE-SHOT 
- SELF-TIMER
- SHUTTER TYPE
- FLICKER REDUCTION
- ISO AUTO SETTING
- IS MODE
- WIRELESS COMMUNICATION
- FLASH FUNCTION SETTING
- TTL-LOCK
- MODELING FLASH
- FULL HD HIGH SPEED REC
- ZEBRA SETTING
- INTERNAL/EXTERNAL MIC LEVEL ADJUSTMENT
- MOVIE SILENT CONTROL
- PREVIEW DEPTH OF FIELD
- PREVIEW EXP/WB IN MANUAL MODE
- NATURAL LIVE VIEW
- HISTOGRAM
- ELECTRONIC LEVEL
- LARGE INDICATORS MODE
- ZOOM/FOCUS CONTROL RING
- CONSTANT SPEED ZOOM (T)
- CONSTANT SPEED ZOOM (W)
- **MF** CONSTANT SPEED FOCUS (N)
- **MF** CONSTANT SPEED FOCUS (F)
- AE LOCK ONLY
- AF LOCK ONLY
- AE/AF LOCK
- AF-ON
- AWB LOCK ONLY
- APERTURE SETTING
- PERFORMANCE
- AUTO IMAGE TRANSFER
- SELECT PAIRING DESTINATION
- Bluetooth ON/OFF
- PLAYBACK
- NONE



- To disable the function button, choose **NONE**.
- Selected function lock is not available when **CONSTANT SPEED ZOOM (T)** or **CONSTANT SPEED ZOOM (W)** is assigned to a lens function button.

Power Zoom Lenses

Zoom can be adjusted on power zoom lenses using the zoom/focus control ring, zoom button, or zoom ring.

⚠ Adjusting zoom while the lens is wet makes it easier for water to find its way inside the lens. Wipe any water from the lens before adjusting zoom.

📄 A XF18-120mmF4 LM PZ WR lens is used here for illustrative purposes.

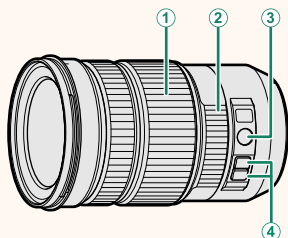

Control	Description
① Zoom ring	Rotate the zoom ring to zoom in or out manually.
② Zoom/focus control ring	Rotate the zoom/focus control ring to zoom in or out using powered zoom. The zoom speed is proportional to the speed with which the ring is rotated.
③ Z/F (zoom/focus) button	Switch the role of zoom/focus control ring from focus to zoom or <i>vice versa</i> .
④ Zoom buttons	Press a zoom button to zoom in or out at a steady speed using powered zoom. Zoom ends when the button is pressed a second time.

- 📄 The **Z/F** and zoom buttons can be assigned other roles using **⚙️ BUTTON/DIAL SETTING > POWER ZOOM LENS FUNCTION (Fn) SETTING**.
- The speed at which zoom can be adjusted via the zoom buttons can be chosen using **⚙️ BUTTON/DIAL SETTING > LENS ZOOM/FOCUS SETTING**.

Connecting to Smartphones

Access wireless networks and connect to computers, smartphones, or tablets. For more information, visit:

<http://fujifilm-dsc.com/wifi/>

Smartphones and Tablets

Installing Smartphone Apps

Before establishing a connection between the smartphone and camera, you will need to install at least one dedicated smartphone app. Visit the following website and install the desired apps on your phone.

<https://app.fujifilm-dsc.com/>





 The apps available vary with the smartphone operating system.

Connecting to a Smartphone

Pair the camera with the smartphone and connect via Bluetooth®.

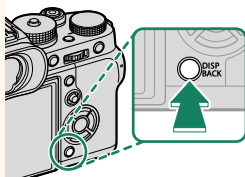
- 1 Press **DISP/BACK** while shooting information is displayed.



 You can also proceed directly to Step 3 by holding the **DISP/BACK** button during playback.

2 Highlight **Bluetooth** and press **MENU/OK**.

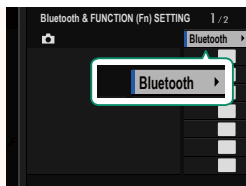

3 Highlight **PAIRING** and press **MENU/OK**.

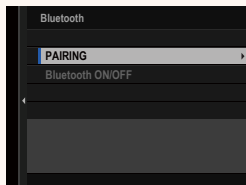

4 Launch the app on the smartphone and pair the smartphone with the camera.

More information is available at the following website:
<https://app.fujifilm-dsc.com/>

When pairing is complete, the camera and smartphone will automatically connect via Bluetooth. A smartphone icon and a white Bluetooth icon will appear in the camera display when a connection is established.

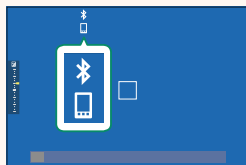

- Once the devices have been paired, the smartphone will automatically connect to the camera when the app is launched.
- Disabling Bluetooth when the camera is not connected to a smartphone reduces the drain on the battery.

Using the Smartphone App

Read this section for information on the options available for downloading pictures to your smartphone using the smartphone app.

 Before proceeding, select **ON** for **Bluetooth/SMARTPHONE SETTING > Bluetooth ON/OFF**.

Selecting and Downloading Pictures Using the Smartphone App

You can download selected pictures to a smartphone using the smartphone app.

 More information is available from the following website:

<https://app.fujifilm-dsc.com/>

Uploading Pictures as They Are Taken

Pictures taken with **ON** selected for  **CONNECTION SETTING > Bluetooth/SMARTPHONE SETTING > AUTO IMAGE TRANSFER ORDER** will automatically be marked for upload to the paired device.

-  If **ON** is selected for both **Bluetooth/SMARTPHONE SETTING > Bluetooth ON/OFF** and **IMAGE TRANSFER WHILE POWER OFF** in the  **CONNECTION SETTING** menu, upload to the paired device will continue even while the camera is off.
- Selecting **ON** for  **CONNECTION SETTING > Bluetooth/SMARTPHONE SETTING > RESIZE IMAGE FOR SMARTPHONE**  enables compression, reducing file size for upload.

Selecting Pictures for Upload in the Playback Menu

Use **IMAGE TRANSFER ORDER > SELECT FRAMES** to select pictures for upload to a paired smartphone or tablet via Bluetooth®.

Copying Pictures to a Computer: PC AutoSave

Install the latest version of FUJIFILM PC AutoSave to your computer to upload pictures from the camera over wireless networks (Wi-Fi).

FUJIFILM PC AutoSave

For downloads and other information, visit:

http://app.fujifilm-dsc.com/en/pc_autosave/

Computers: Wireless Connections

You can upload pictures from the camera using the **PC AUTO SAVE** option in the playback menu.



Accessories from Fujifilm

The following optional accessories are available from Fujifilm. For the latest information on the accessories available in your region, check with your local Fujifilm representative or visit http://www.fujifilm.com/products/digital_cameras/index.html.

Rechargeable Li-ion batteries

NP-W126/NP-W126S: Additional high-capacity NP-W126/NP-W126S rechargeable batteries can be purchased as required.

Battery chargers

BC-W126/BC-W126S: Replacement battery chargers can be purchased as required. At +20°C/+68°F, the BC-W126/BC-W126S charges an NP-W126/NP-W126S in about 150 minutes.

DC couplers

CP-W126: For extended shooting or playback or when using the camera with a computer, use the CP-W126 to connect the camera to the AC-9VS power adapter supplied with optional vertical battery grips.

Remote releases

RR-100: Use to reduce camera shake or keep the shutter open during a time exposure (ø2.5 mm).

Stereo microphones

MIC-ST1: An external microphone for movie recording.

FUJINON lenses

XF-/XC-series lenses: Interchangeable lenses for use exclusively with the FUJIFILM X-mount.

FUJINON MKX-series lenses: Cinema lenses for the FUJIFILM X-mount.

Macro extension tubes

MCEX-11/16: Attach between the camera and the lens to shoot at high reproduction ratios.

Teleconverters

XF1.4X TC WR: Increases the focal length of the compatible lenses by about 1.4x.

XF2X TC WR: Increases the focal length of the compatible lenses by about 2.0x.

Mount adapters

FUJIFILM M MOUNT ADAPTER: Allows the camera to be used with a wide selection of M-mount lenses.

Body caps

BCP-001: Cover the camera lens mount when no lens is attached.

Eye cups

EC-XH W/EC-XT L/EC-XT M/EC-XT S/EC-GFX: Attach viewfinder eyecups to prevent light leaking into the viewfinder window.

Shoe-mounted flash units

EF-X500: In addition to manual and TTL flash control, this clip-on flash unit has a Guide Number of 50/164 (ISO 100, m/ft.) and supports FP (high-speed sync), allowing it to be used at shutter speeds that exceed the flash sync speed. Featuring support for the optional EF-BP1 battery pack and Fujifilm optical wireless flash control, it can be used as a master or remote flash unit for remote wireless flash photography.

EF-BP1: A battery pack for shoe-mounted flash units. Takes up to 8 AA batteries.

EF-42: This clip-on flash unit has a Guide Number of 42/137 (ISO 100, m/ft.) and supports manual and TTL flash control.

EF-X20: This clip-on flash unit has a Guide Number of 20/65 (ISO 100, m/ft.) and supports manual and TTL flash control.

EF-20: This clip-on flash unit has a Guide Number of 20/65 (ISO 100, m/ft.) and supports TTL flash control (manual flash control is not supported).

Vertical battery grips

VG-XT3: See "Vertical battery grips".

Tripod grips

TG-BT1: Record movies, take photographs, or adjust zoom on compatible power zoom lenses while holding this Bluetooth tripod grip.

Hand grips

MHG-XT3: Features an improved grip. Batteries and memory cards can be removed with the grip in place, and the grip is equipped with a rail for quick-shoe camera mounts.

Leather cases

BLC-XT3: This case combines practicality with the luxury of leather and comes with a cloth that can be used to wrap the camera before putting it in the case and on other occasions. Pictures can be taken and batteries inserted or removed with the camera still in its case.

Grip belts

GB-001: Improves grip. Combine with a hand grip for more secure handling.

Cover kits

CVR-XT3: A set of covers for the X-T3. Contains a sync terminal cap, a hot-shoe cover, and a connector cover, as well as two vertical battery grip connector covers (one black and one silver).

instax SHARE printers

SP-1/SP-2/SP-3: Connect via wireless LAN to print pictures on instax film.



This camera is not compatible with the AC-9V AC power adapter.

FUJIFILM

FUJIFILM Corporation

7-3, AKASAKA 9-CHOME, MINATO-KU, TOKYO 107-0052, JAPAN

<https://fujifilm-x.com>

