

MAGEWELL®

Pro Convert™ Encoders

User Manual, Reference and FAQ



TABLE OF CONTENTS

Getting Started	03		
Overview	03		
Key Features	03		
System Requirements	04		
Installation	05		
Safety Information	05		
Interfaces & Indicators	06		
Connections	10		
Web UI Configuration	12		
Accessing the Web UI	12		
Signing In/Out	16		
Dashboard	17		
Signal	22		
Video	27		
EDID	30		
NDI®	33		
PTZ	41		
		System	45
		Rebooting/Resetting Pro Convert	56
		FAQ	58
		Support	73
		Warranty	74
		Notice	76
		Glossary and Abbreviations	77

Getting Started

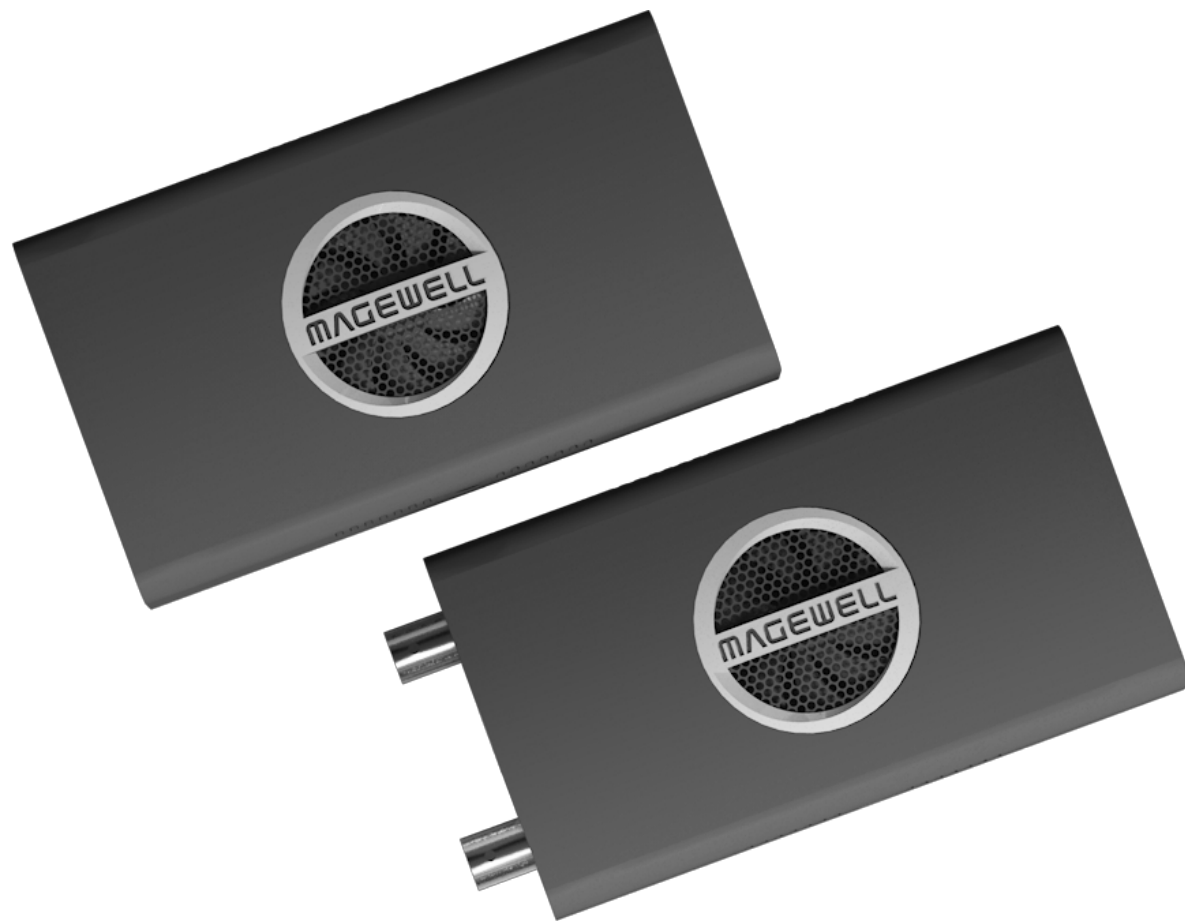

Overview

Pro Convert™ family of NDI® encoders, built on NewTek's extremely popular NDI media-over-IP technology, help users reliably bring traditional video signals into IP-based live production and AV infrastructures. Available in 4K and 1080p60 configurations with a choice of input interfaces, the converters enable users to easily and cost-effectively connect their existing equipment into NDI-enabled networks.

The ultra-compact Pro Convert devices are ideal for both in-studio and portable field use. Value-added features for live production applications include a 1/4"-20 thread for standard camera-mounting accessories, preview and program tally lights, and NDI-based PTZ camera control. The units can be powered by the included AC adapter or via Power over Ethernet (PoE) for further deployment simplicity.

Key Features

- Support for NDI.
- Support for encoding videos and embedded audio.
- Support for PoE (Power over Ethernet).
- Support for plug-and-play.
- Support for Ethernet over USB.
- Support for connection and management of PTZ camera.
- Support for web-based UI remote control.

System Requirements

Network

- Gigabit Ethernet

Supported Web Browser for the Web UI

- Google Chrome version 49 and above
- Microsoft Internet Explorer 11
- Microsoft Edge
- Mozilla Firefox version 61 and above
- Apple Safari 11.1 and above
- Opera 55.0.2994.44 and above

Supported Software

- OBS
- XSplit
- vMix
- VidBlasterX
- Wirecast
- streamstar SW
- mimoLive
- Any other NewTek NDI[®] based decoding or streaming software

Pro Convert Encoder

Magewell has launched the following Pro Convert NDI[®] encoders, and there are more products to be released. For the latest listed converters, please visit our official website to find the [Pro Convert Encoder Family](#).

- Pro Convert HDMI 4K Plus
- Pro Convert HDMI Plus
- Pro Convert HDMI TX
- Pro Convert 12G SDI 4K Plus
- Pro Convert SDI 4K Plus
- Pro Convert SDI Plus
- Pro Convert SDI TX

Installation

Safety Information

Electrical Safety

- Seek professional assistance before using an adapter or extension cord. These devices could interrupt the grounding circuit.
- Make sure that you are using the correct power adapter for the local voltage. If you are not sure about the voltage of the electrical outlet you are using, contact your local power company.
- If the power adapter is broken, do not try to fix it by yourself. Contact a qualified service technician or your retailer for help.

Operation Safety

- Before using the product, make sure all cables are correctly connected and the power cables are not damaged. If you notice any damage, contact your dealer immediately.
- To avoid short circuits, keep paper clips, screws, and staples away from connectors, slots, sockets and circuitry.
- Avoid dust, humidity, and temperature extremes. Do not place the product in any area where it may become wet.
- Place the product on a stable surface.
- If you encounter technical problems with the product, contact your dealer or the Magewell Support Team via support@magewell.net.

Interfaces & Indicators

Input interface of Pro Convert varies according to its supported signal type.

Pro Convert HDMI 4K Plus/Pro Convert HDMI Plus

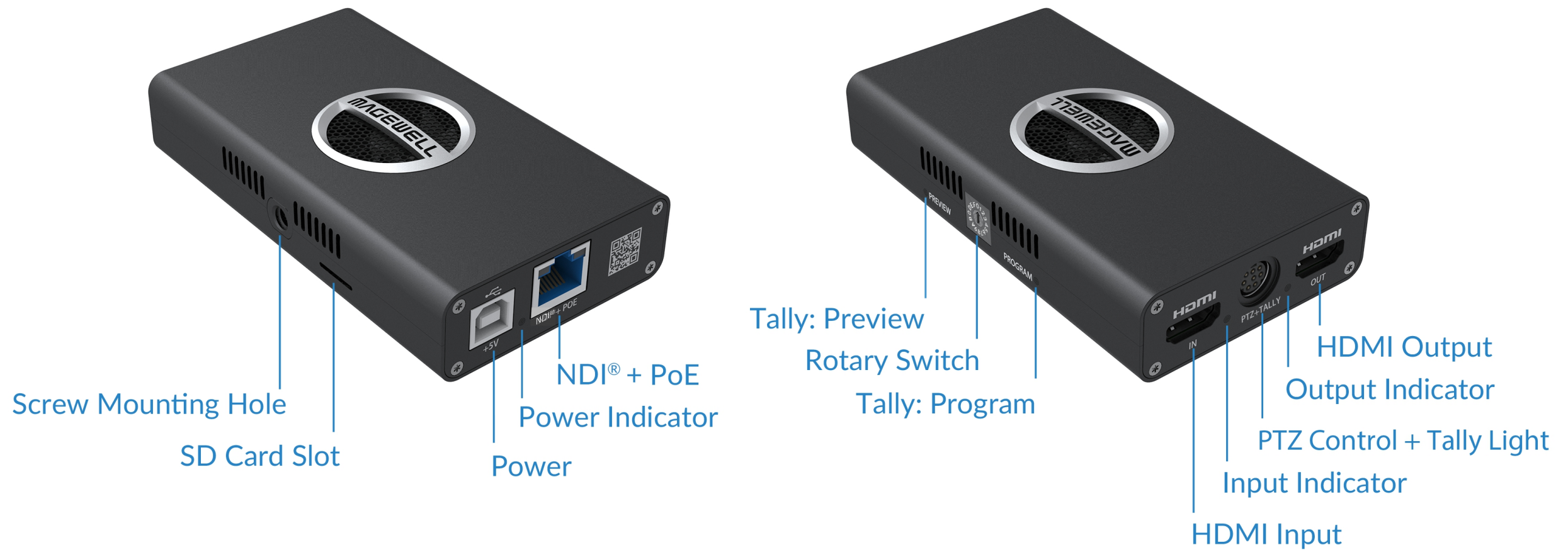

Note: The SD card function is not available currently.

Pro Convert 12G SDI 4K Plus/Pro Convert SDI 4K Plus/Pro Convert SDI Plus

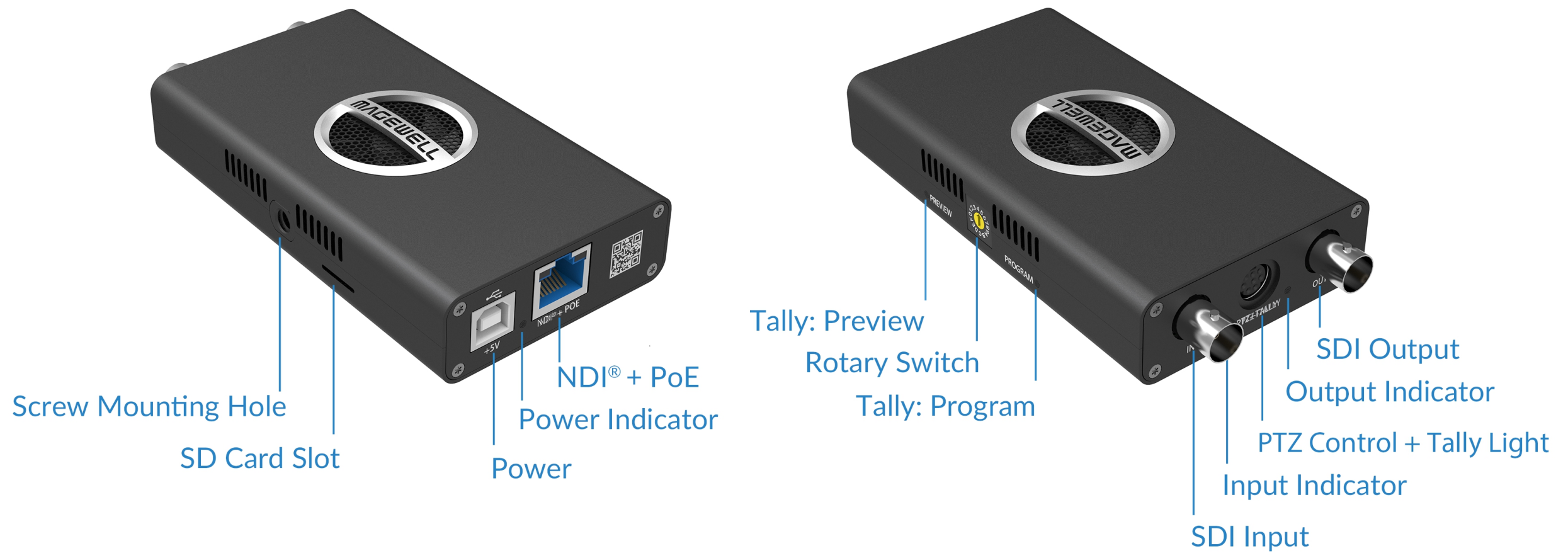

Note: The SD card function is not available currently.

Pro Convert HDMI TX

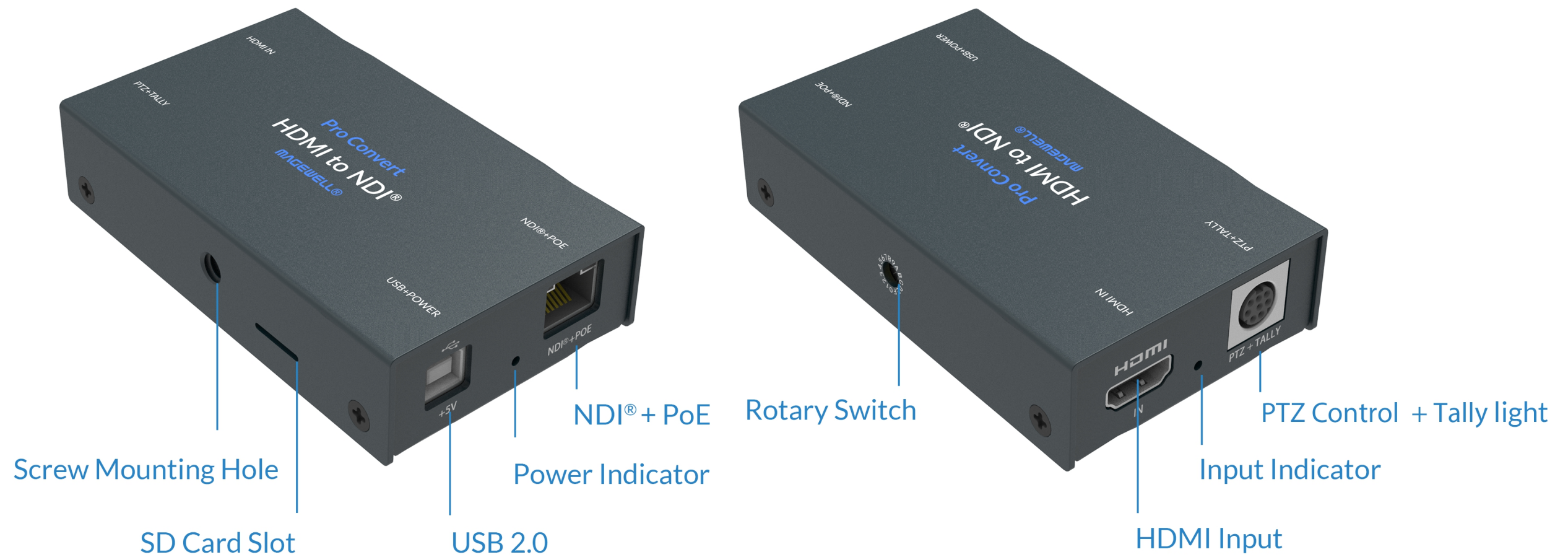

Note: The SD card function is not available currently.

Pro Convert SDI TX

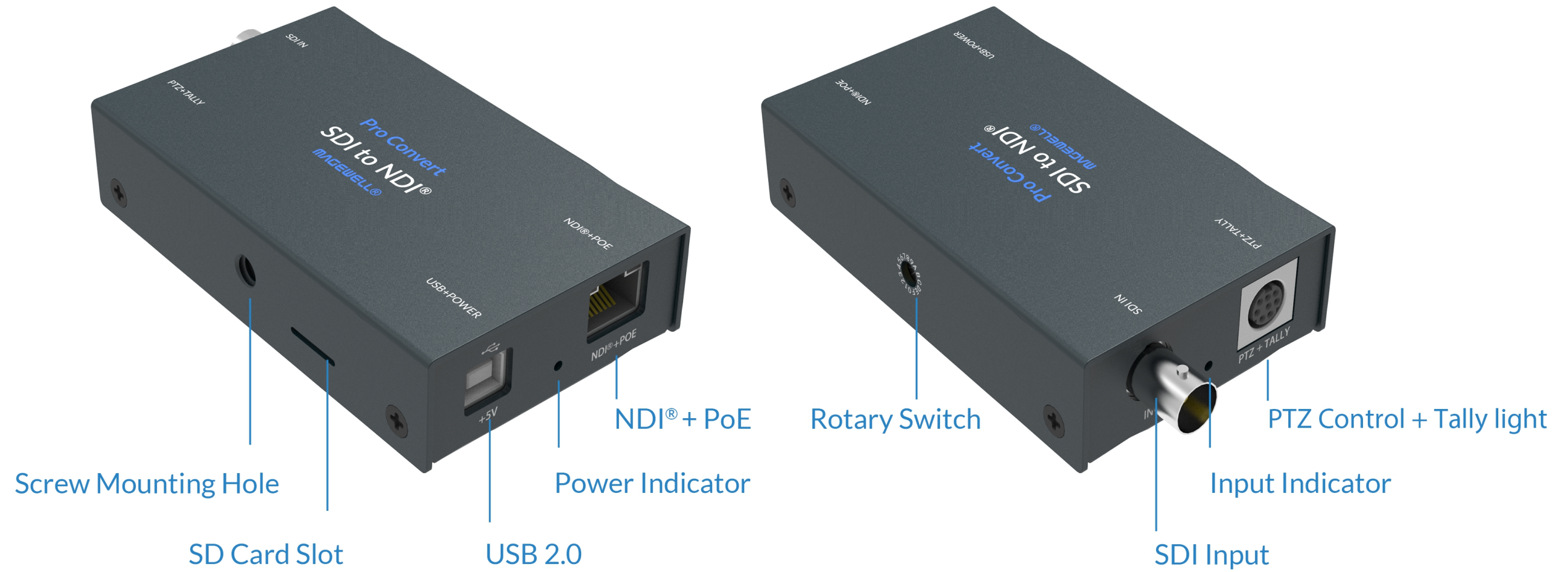

Note: The SD card function is not available currently.

Connections

Interfaces and cables varies according to signal supported by Pro Convert. Here takes Pro Convert HDMI 4K Plus as an example to describe the cabling.

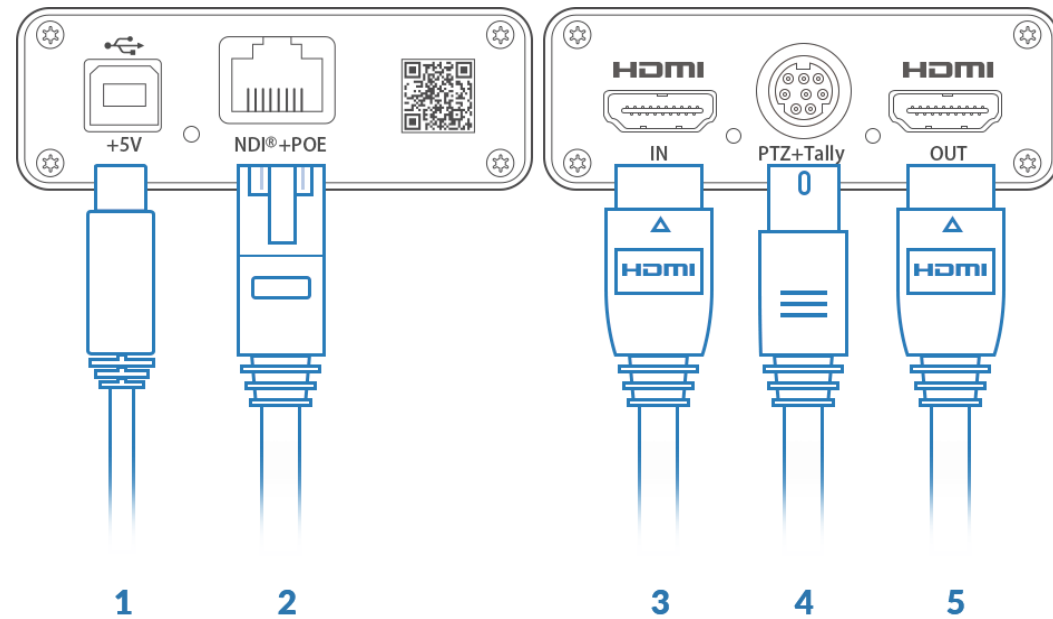

Figure1. Pro Convert HDMI 4K Plus/Pro Convert HDMI Plus

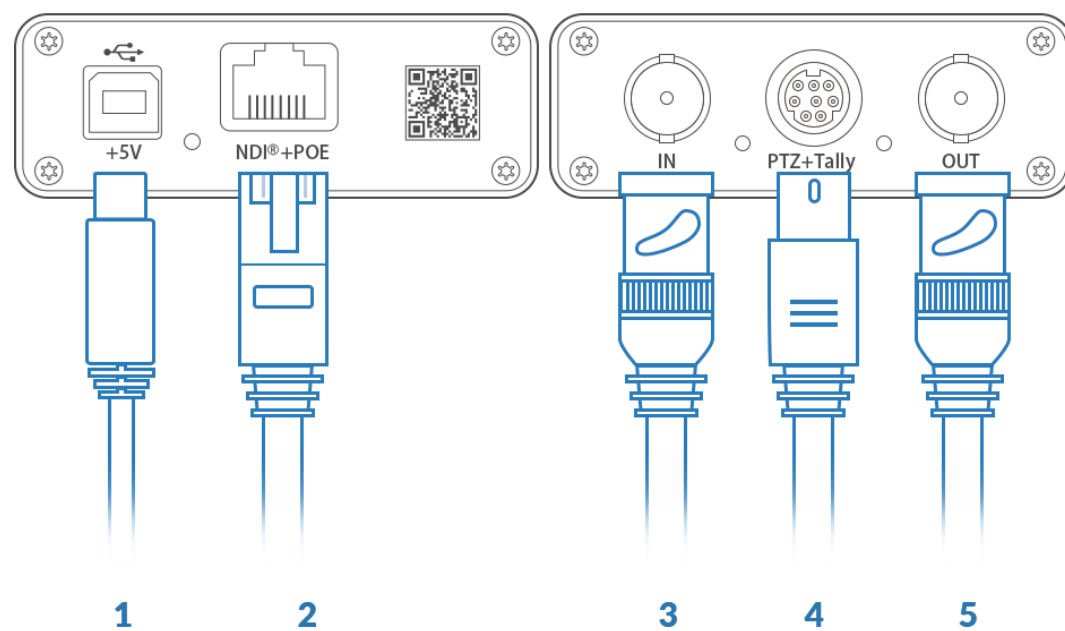

Figure2. Pro Convert 12G SDI 4K Plus/Pro Convert SDI 4K Plus/Pro Convert SDI Plus

1. Plug in the USB cable.
 - For power supply: Connect the other end of the USB cable to the power adapter.
 - For Ethernet over USB (RNDIS/ECM): Connect the other end of the USB cable to your computer.
2. Plug in the Ethernet cable.
 - For PoE: Connect the other end of the Ethernet cable to a PoE switch or a PoE adapter for power and Ethernet connection.
 - For Ethernet connection: To ensure high speed transmission, it is recommended to connect the Pro Convert unit to a gigabit network.
3. Plug in the HDMI/SDI cable to connect to the input signal source.
4. Plug in a PTZ cable to connect to a PTZ camera, an external Magewell Tally light, or a LED matrix screen.
5. Plug in another HDMI/SDI cable to loopthrough the signal (if needed). There is not an output interface in the Pro Convert HDMI/SDI TX devices.

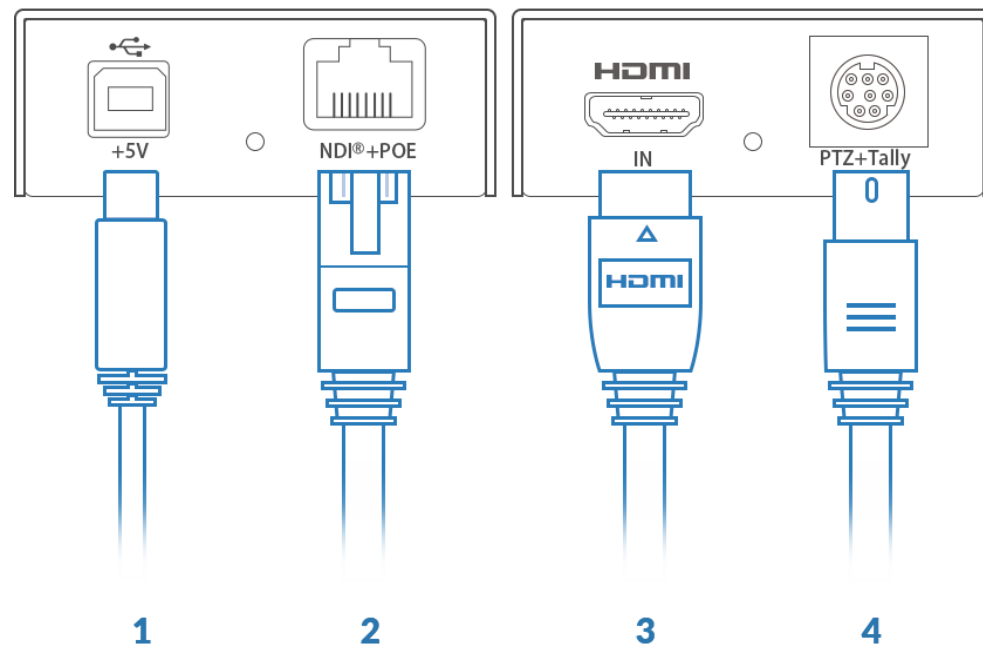

Figure3. Pro Convert HDMI TX

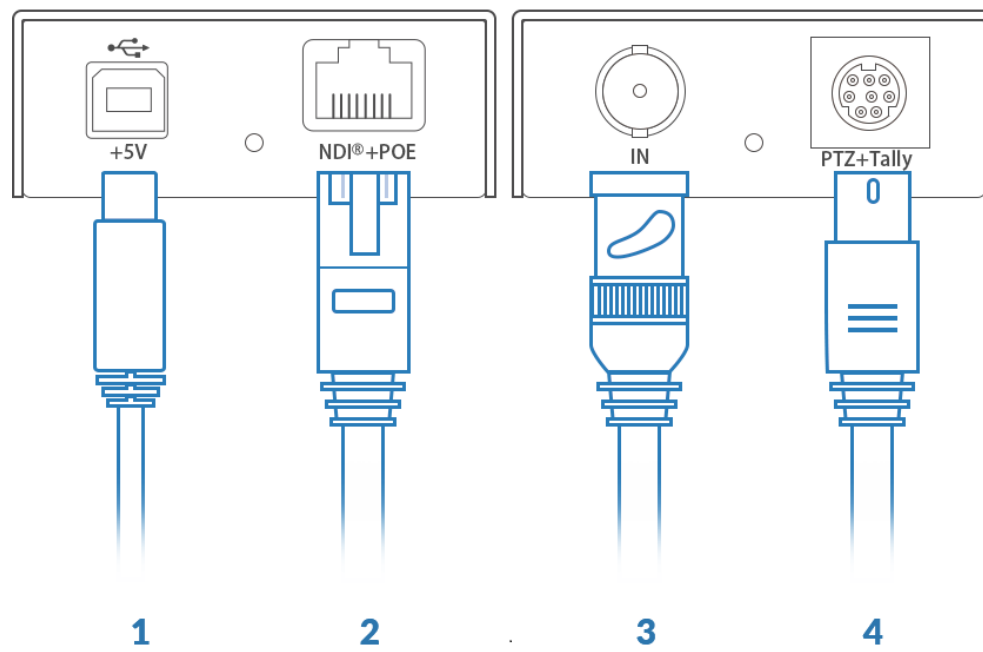

Figure4. Pro Convert SDI TX

Web UI Configuration

Pro Convert allows to be controlled via a web-based user interface. With the Web UI, you can monitor the device's working status, input signal status, and configure settings for your sessions.

This chapter takes the Pro Convert HDMI 4K Plus as an example to describe how to access and remotely control your unit via the Web UI, other products consider the same operations.

Accessing the Web UI



If you know your device's IP address, type it into your web browser to display the Web UI. Alternatively, you can access the Web UI in one of the following ways. (1) For Windows7/8/8.1/10 users, you can find and access your Pro Convert device as a Network device in a File Explorer window. (2) Using the Ethernet over USB function. (3) Using NewTek's NDI Studio Monitor, if it's installed on your system.

Solution 1: using Windows File Explorer

This method is available for Windows7/8/8.1/10 users.

Step 1 Connect your converter via Ethernet and power it up as shown on the left Figure1. Connections.

Step 2 Open a **File Explorer** window in one of the following ways.

- Click on the **Start**  button and find File Explorer in the Start menu.
- Press the Windows logo key  + E.
- Select the folder icon on the taskbar.

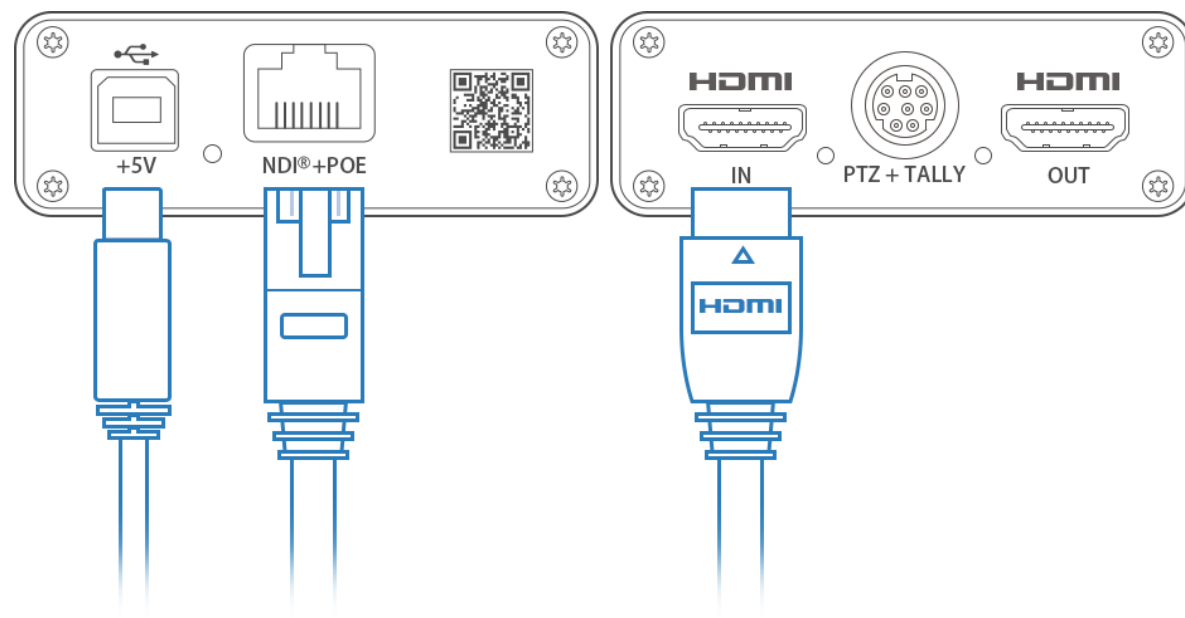

Figure1. Connections

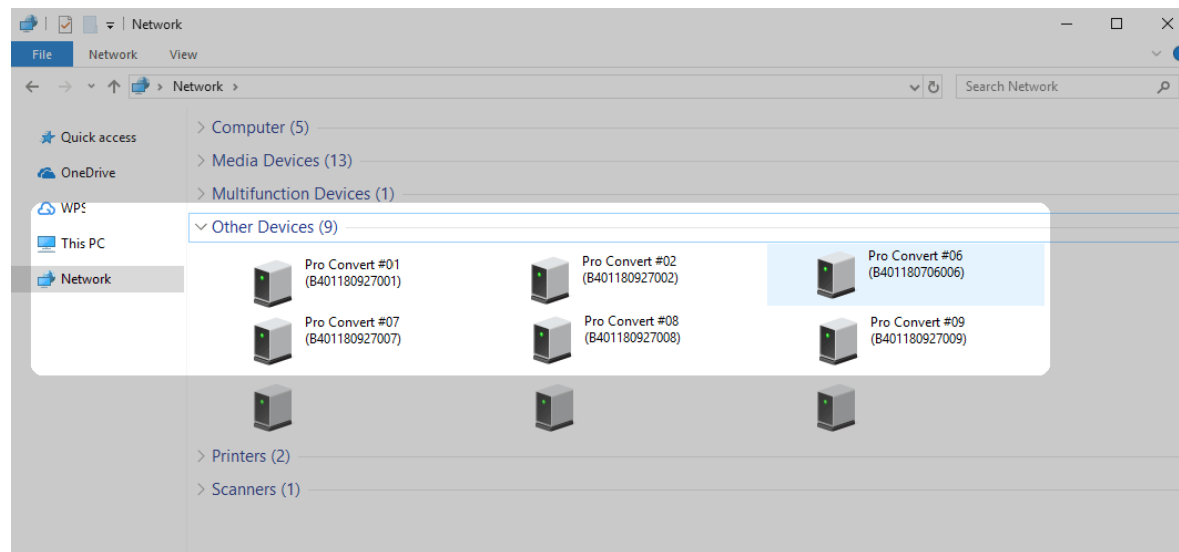
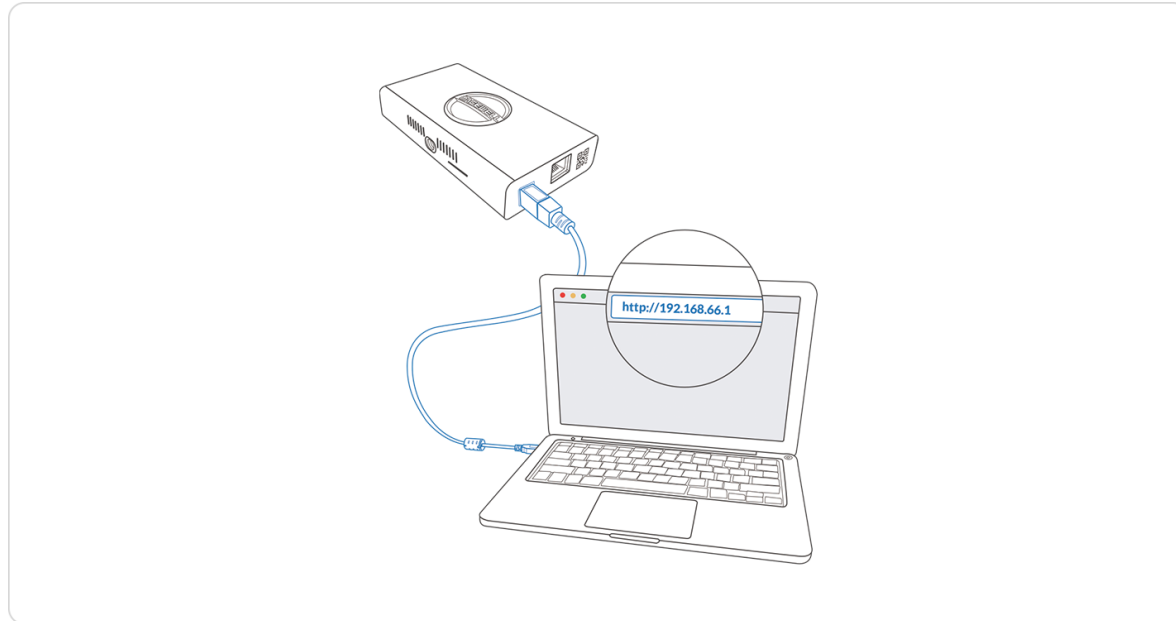

Figure2. Find your Pro Convert device in the Network > Other Devices section

- Step 3** Select the **Network** at the bottom of the list of items on the left side of the File Explorer.
- Step 4** Turn on the network discovery function if prompted.
- Step 5** Find your Pro Convert device in the **Other Devices** section, where it will be shown as "**Pro Convert + #board index + (serial number)**".
- The **serial number** (marked on your device) will be in a form like "B401180706006".
 - The **board index** (the rotary switch number on your device) is shown like "06" or "#06".
- Step 6** Double click the converter icon to open the Web UI of the device in your web browser.



Solution 2: using Ethernet over USB

RNDIS (For Microsoft)/ECM (For Mac/Linux) provides a virtual Ethernet link to the computer's operating system.

Step 1 Connect the device and your computer using a USB cable as shown on the left.

Step 2 Type the Ethernet over USB IP address in your web browser. The default address is <http://192.168.66.1>.

The pop-up web UI of the connected device will be shown in your browser.

Please do not change it unless there is a conflict in your network.

⚠ Do not connect more than one converter simultaneously to the same system via Ethernet over USB.

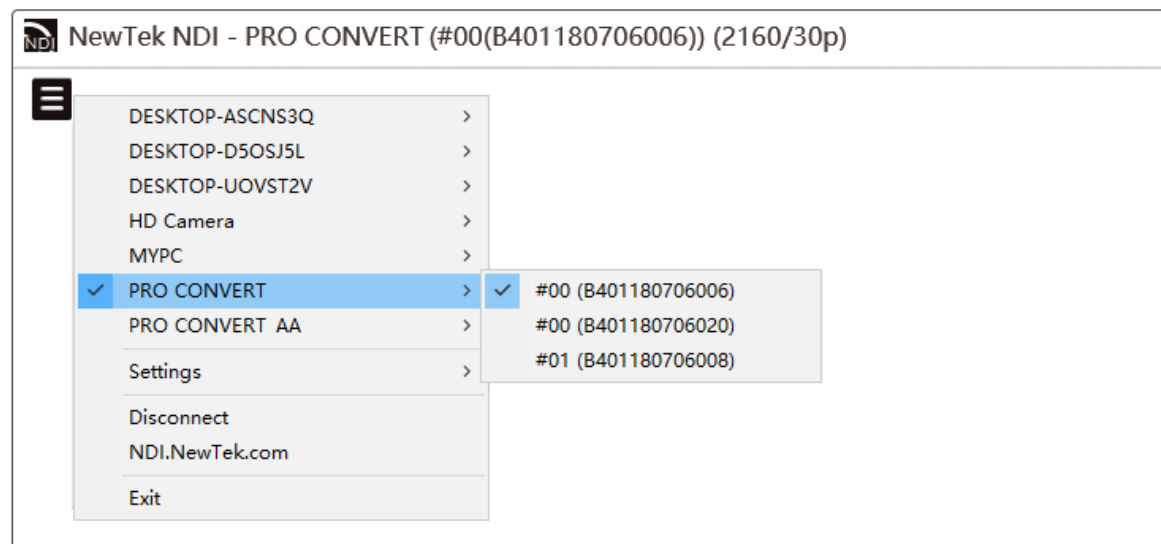

Figure1. Select NDI stream in NDI Studio Monitor

Solution 3: using the NDI Studio Monitor

Step 1 Connect your converter via Ethernet and power it up as shown in the [Figure1. Connections](#) in Solution 1.

The unit will automatically obtain an IP address by default. If you want to set up a fixed IP address for your device, see [Setting Network](#).

Step 2 Download and install the free NDI Studio Monitor software on a computer which is in the same LAN as the converter. The software can be found on the NewTek official website at www.newtek.com/ndi/tools.

Step 3 Launch the **NDI Studio Monitor** software on your computer.

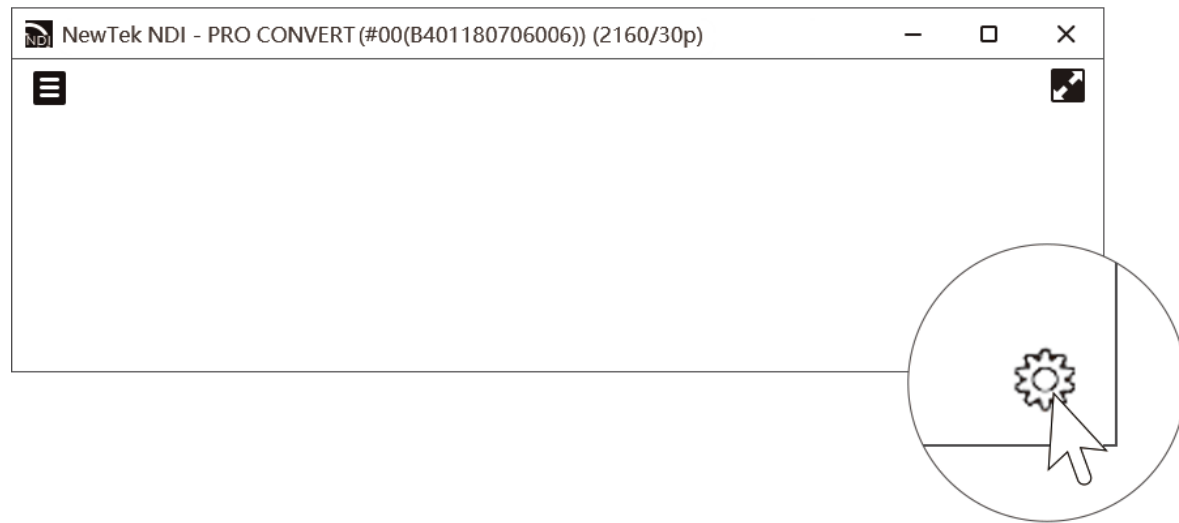



Figure2. Click the gear icon to open the Web UI

The application will automatically search for compatible devices on the same LAN.

Step 4 Click Menu button  at the top-left of the window, and select your converter - device name > channel name.

The video stream from the chosen channel will be displayed.

Step 5 Click the gear icon at the bottom right of the Studio Monitor.

The pop-up web UI of the selected device will be shown in your web browser.

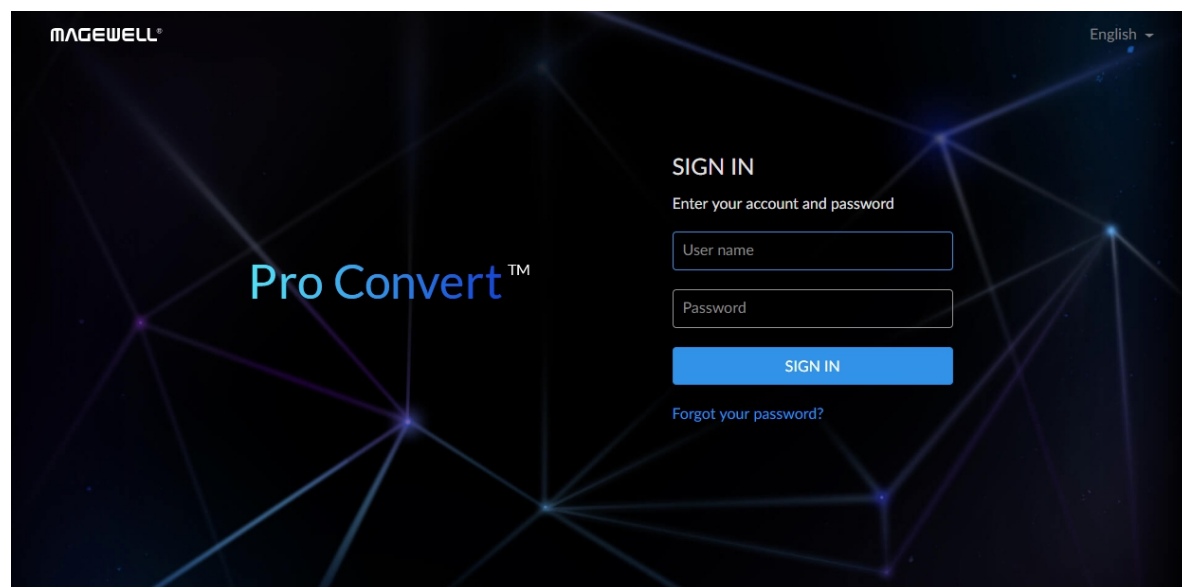



Signing In/Out

The Web UI allows multi-users to have read/write access to make configuration settings at the same time after login. However, to avoid configuration conflicts, do not operate one device simultaneously.

Step 1 Signing In: Enter your account and password in the **SIGN IN** page.

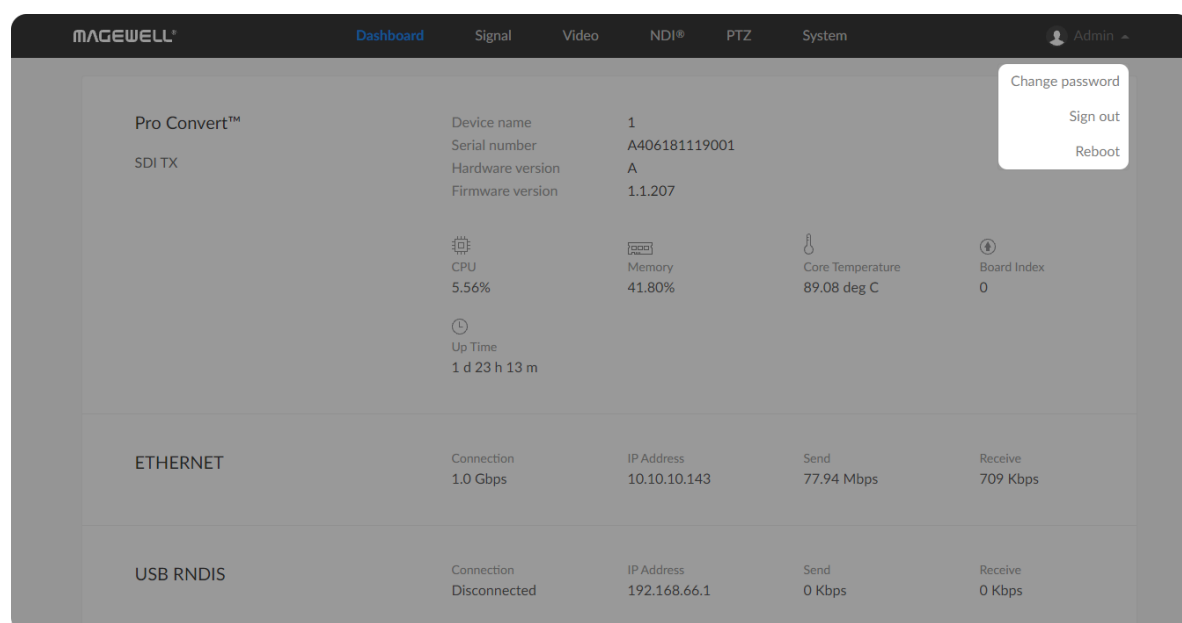
- The default administrator account name and password are as follows:
Username: **Admin**
Password: **Admin**
- It is recommended to change the admin password after login (see [modify the admin password](#)). Unlike the password, the administrator username cannot be modified.
- Your account will sign out automatically if there is no operation performed within ten minutes.



Step 2 Signing Out: Click the drop-list icon  behind your username at the top-right of the Web UI, and select **Sign out**.

The **Reboot** function requires administrative rights.

Dashboard

The Dashboard tab in the web UI can show the real-time status and parameters of the Pro Convert device. Click and enter the **Dashboard** tab to check the device status.

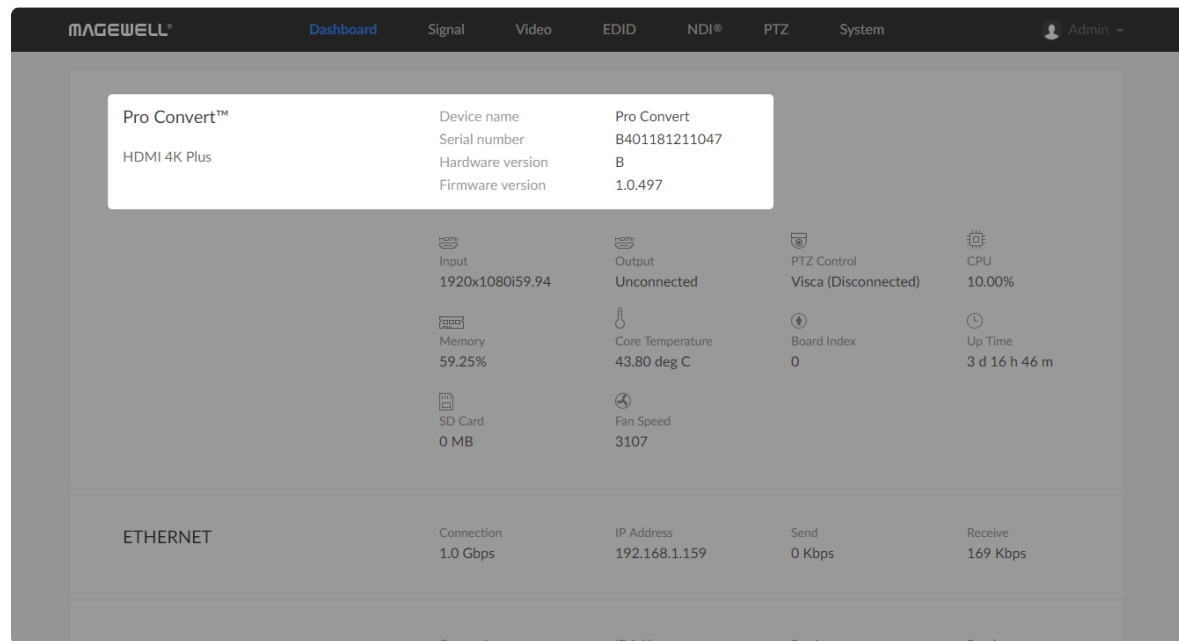

Checking Basic Information

- **Device name** shows the name of your Pro Convert unit. Only the Administrator can modify the device name in the System > Network tab. For detailed information, refer to [Setting Device Name](#).
- **Serial number** shows the serial number of your unit, which is also marked on your device.
- **Hardware version** shows the hardware version of your unit.
- **Firmware version** shows the current firmware version that's installed in your unit. Only the Administrator can update the firmware, via the Firmware tab. For detailed information, refer to [Updating the Firmware](#).

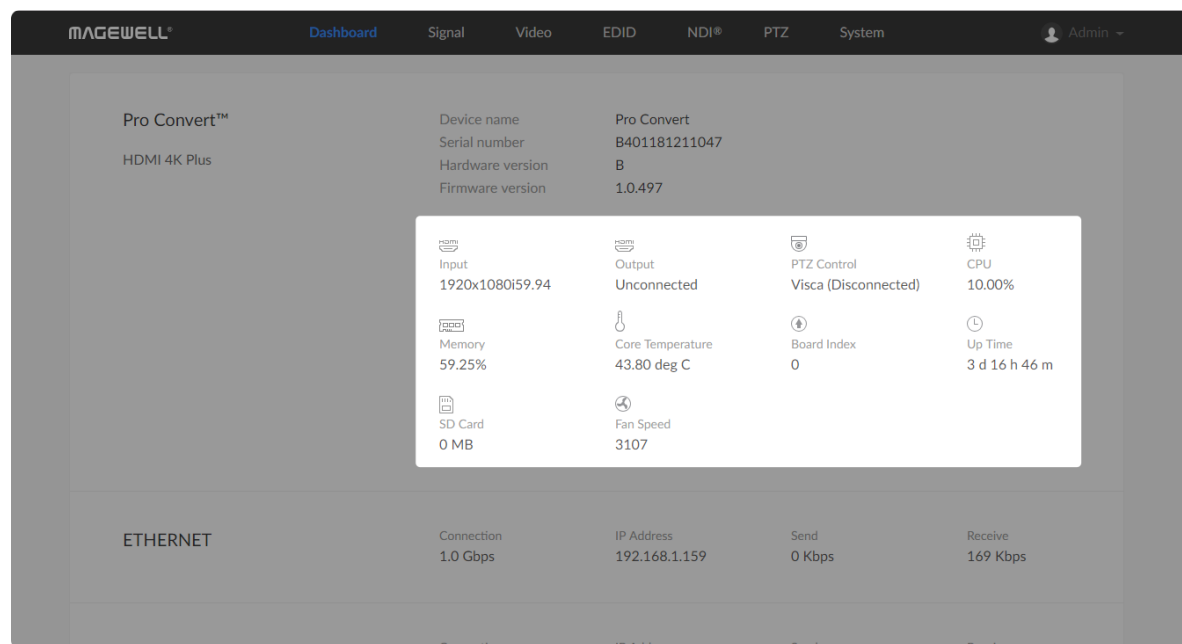

Checking the Current Working Status

- **Input** shows the resolution and frame rate of the current input signal. For more detail about the input, go to the **Signal** tab.
- **Output** shows whether an output device is connected to the Pro Convert device.
NOTE: This parameter is not available for TX models.
- **PTZ Control** shows the current protocol configured for the converter to communicate with a PTZ camera in the **PTZ** tab.
- **CPU** shows the current CPU usage (the load on the processor, shown as a percentage) of the Pro Convert device. CPU usage increases when the device is handling more complex video processing tasks (e.g. encoding at higher resolutions and frame rates).
- **Memory** shows current memory usage. You can find out the free memory in **System > Report** tab, subject to administrative rights.
- **Core Temperature** shows the current temperature of the unit's processor. Keeping the device free from dust and avoiding a high-temperature work environment may help to avoid overheating of the device. If the core temperature is approaching 100°C, please try to lower the temperature by ensuring a supply of cooler air.
- **Board Index** shows the rotary switch number. You can change the number on the rotary switch to set a different Board Index, which can be used in the generation of the NDI source name.
- **Up Time** shows the elapsed time since your device's last boot-up.
- **SD Card** shows the capacity of current inserted SD card.

The screenshot displays the MAGEWELL web interface. The top navigation bar includes 'Dashboard', 'Signal', 'Video', 'EDID', 'NDI*', 'PTZ', and 'System'. The main content area shows system information for a 'Pro Convert™ HDMI 4K Plus' device. Below this, there are several status indicators: Input (1920x1080p60.00), Output (Unconnected), PTZ Control (None), CPU (10.53%), Memory (59.14%), Core Temperature (53.77 deg C), Board Index (0), and Up Time (3 d 46 m). A table at the bottom shows network status for 'ETHERNET' and 'USB RNDIS'.

Device Name	Device Model	Serial Number	Hardware Version	Firmware Version
Pro Convert™	HDMI 4K Plus	B401180706006	B	1.0.276

Input	Output	PTZ Control	CPU
1920x1080p60.00	Unconnected	None	10.53%
Memory	Core Temperature	Board Index	Up Time
59.14%	53.77 deg C	0	3 d 46 m
SD Card	Fan Speed		
0 MB	3107		

Interface	Connection	IP Address	Send	Receive
ETHERNET	1.0 Gbps	192.168.1.60	61.97 Mbps	525 Kbps
USB RNDIS	High Speed	192.168.66.1	0 Kbps	0 Kbps

- **Fan Speed** shows the current speed of fan, which automatically changes according to temperature.

NOTE: This parameter is not available for TX products.

Checking Ethernet Status

- **Connection** shows Ethernet network connection status.
- **IP Address** shows Ethernet IP Address. You can manually change it in the **System > Network** tab with administrative rights.
- **Send** shows the current Ethernet transmission speed. NDI can generate high bitrate, dependent on resolution, frame rate and picture content. Observing this value will help to guide you in determining how many NDI streams your LAN can handle.
- **Receive** shows the current Ethernet receive speed.

HDMI 4K Plus				
Serial number	B401180706006			
Hardware version	B			
Firmware version	1.0.276			
Input	Output	PTZ Control	CPU	
1920x1080p60.00	Unconnected	None	10.53%	
Memory	Core Temperature	Board Index	Up Time	
59.14%	53.77 deg C	0	3 d 46 m	
SD Card	Fan Speed			
0 MB	3107			
ETHERNET				
Connection	IP Address	Send	Receive	
1.0 Gbps	192.168.1.60	61.97 Mbps	525 Kbps	
USB RNDIS				
Connection	IP Address	Send	Receive	
High Speed	192.168.66.1	0 Kbps	0 Kbps	
NDI®				
<input checked="" type="checkbox"/>	General	Tally	QoS	Encoding
	Name	Preview	Video drop frames	Video
	#00 (B401180706006)	<input type="radio"/> Off	0	33.90 Mbps

ETHERNET				
Connection	IP Address	Send	Receive	
1.0 Gbps	192.168.1.159	0 Kbps	50 Kbps	
USB RNDIS				
Connection	IP Address	Send	Receive	
Disconnected	192.168.66.1	0 Kbps	0 Kbps	
NDI®				
<input checked="" type="checkbox"/>	General	Tally	QoS	Encoding
	Name	Preview	Video drop frames	Video
	HDMI 4K Plus	<input type="radio"/> Off	0	0 Kbps
	Clients	Program	Audio drop frames	Audio
	0	<input type="radio"/> Off	0	0 Kbps
	Video	Audio		
	Resolution	Sampling	48000, 16 bits	
	N/A	Channels	8	
	Field rate	0.00 fps		

Checking Ethernet over USB Status

- **Connection** shows Ethernet over USB connection status.
- **IP Address** shows Ethernet over USB IP Address.
By default, it is **192.168.66.1**. You can manually change it in the **System > Network** tab, with administrative rights.
- **Send** shows current Ethernet over USB send speed.
- **Receive** shows current Ethernet over USB receive speed.

Checking NDI® Status

Setting NDI parameters refers to [NDI](#).

⚠ Do not turn off NDI® during video transmission.

- **General** shows NDI source information.
 - **Name** shows NDI source name configured in the **NDI®** tab.
 - **Clients** shows the total number of NDI clients receiving the streams sent by your converter.
- **Tally** shows NDI outputs "on-air" status.
 - **Preview** shows whether the NDI stream has been selected to the Preview bus by any client. If yes, it shows **On** and is green, otherwise, it is **Off** and grey.

- **Program** shows whether the NDI stream has been selected to the Program bus by any client. If yes, it shows **On** and is red, otherwise, it is **Off** and grey.
- **QoS** shows the number of frames dropped in the previous second.
 - **Video drop frames** shows dropped video frames in the previous second.
 - **Audio drop frames** shows dropped audio frames in the previous second.
- **Encoding** shows the encoding speed in the previous second.
 - **Video** shows the video bitrate for the previous second.
 - **Audio** shows the audio bitrate for the previous second.
- **Video** shows output NDI video information.
 - **Resolution** shows the NDI video output resolution that is [configured in the Video > OUTPUT section](#).
 - **Field rate** shows the NDI video output field rate that is [configured in the Video > OUTPUT section](#).
- **Audio** Shows NDI audio information.
 - **Sampling** shows the sampling rate and bit depth of the audio output.
 - **Channels** shows the total number of NDI audio input channels. The HDMI Plus/4K Plus converter supports up to 8 input/output channels, SDI converter supports 16 input/output channels, and HDMI TX supports 8 input channels and the first 2 output channels.

Signal

Click and enter the **Signal** tab to check the input signal information detected by the device. The parameters vary with input signal source.

The screenshot shows the MAGEWELL Signal tab interface. The VIDEO STATUS section is highlighted with a white background. Below it are the AUDIO STATUS and HDMI STATUS sections, which are dimmed.

VIDEO STATUS	
Resolution	1920×1080p, 60.00 Hz
Color depth	8
Sampling	4:4:4
Aspect ratio	16:9
Color format	BT.709
Frame struct	2D
Quantization range	Limited
Saturation range	Limited

AUDIO STATUS	
Sampling	48000, 16 bits
Channels	2

HDMI STATUS	
Mode	HDMI
HDCP encrypted	None
VIC	16
IT content	False

Checking VIDEO STATUS

- **Resolution** shows the input video pixel resolution & frame rate.
- **Color depth** shows the input video color depth, in bits.
- **Sampling** shows the input video color sampling format.
- **Aspect ratio** shows the input video aspect ratio.
- **Color format** shows the input video color encoding format.
- **Frame struct** shows the input video frame type, 2D or 3D.
- **Quantization range** shows the quantization range, Full or Limited.
- **Saturation range** shows the saturation range, e.g. Full or Limited.

The screenshot shows the MAGEWELL Signal tab interface. The AUDIO STATUS section is highlighted with a white background. Above it are the VIDEO STATUS and HDMI STATUS sections, which are dimmed.

VIDEO STATUS	
Resolution	1920×1080p, 60.00 Hz
Color depth	8
Sampling	4:4:4
Aspect ratio	16:9
Color format	BT.709
Frame struct	2D
Quantization range	Limited
Saturation range	Limited

AUDIO STATUS	
Sampling	48000, 16 bits
Channels	2

HDMI STATUS	
Mode	HDMI
HDCP encrypted	None
VIC	16
IT content	False

Checking AUDIO STATUS

- **Sampling** shows the input audio sampling rate and bit depth.
- **Channels** shows the number of input audio channels detected.

The screenshot shows the MAGEWELL web interface with the following sections:

- AUDIO STATUS:**

Sampling	48000, 16 bits
Channels	2
- HDMI STATUS:**

Mode	HDMI
HDCP encrypted	None
VIC	16
IT content	False
Pixel rate	148.50 MHz
Timing-H total	2200 Pixels
Timing-H active	1920 Pixels
Timing-H front porch	88 Pixels
Timing-H sync width	44 Pixels
Timing-H back porch	148 Pixels
Timing-V total	1125 Lines
Timing-V active	1080 Lines
Timing-V front porch	4 Lines
Timing-V sync width	5 Lines
Timing-V back porch	36 Lines
- INFO FRAME:**

AVI	
Type	0x82

Checking HDMI STATUS

NOTE: This parameter is available for HDMI products.

- **Mode** shows the signal type (which is always HDMI for the HDMI product).
- **HDCP encrypted** shows whether the signal source is HDCP encrypted. In accordance with the related laws and regulations, the device doesn't process HDCP encrypted signals, so the value is None.
- **VIC** Video Identification Code, which is defined for CEA formats.
- **IT content** shows whether the transmission package is content.
- **3D struct** shows the layout of the two views within a video frame for stereoscopic 3D video. This parameter is only available for 3D signals.
- **3D sub sampling** shows the method for subsampling 3D video. This parameter is only available for 3D input signals.
- **Pixel rate** shows the maximum number of pixels the unit could possibly write to the local memory in one second.
- **Timing-H total** shows the total number of pixels, horizontally.
- **Timing-H active** shows the number of active pixels, horizontally.
- **Timing-H front porch** shows the Front Porch width in pixels.
- **Timing-H sync width** shows the Sync Pulse width in pixels.
- **Timing-H back porch** shows Back Porch width in pixels.
- **Timing-V total** shows the total number of pixels, vertically.
- **Timing-V active** shows the number of active pixels, vertically.
- **Timing-V front porch** shows the size of the vertical Front Porch in pixels.
- **Timing-V sync width** shows the width of the vertical Sync Pulse in pixels.

VIDEO STATUS	
Resolution	1920x1080p, 60.00 Hz
Color depth	10
Sampling	4:2:2
Aspect ratio	16:9
Color format	BT.709
Frame struct	2D
Quantization range	Limited
Saturation range	Limited

AUDIO STATUS	
Sampling	48000, 24 bits
Channels	8

SDI STATUS	
Link type	Single link
Link speed	3G
Stream type	Single stream
Level B	False
Interlaced	False
Assignment	0
ST 352 payload ID	0x00000000
H total	2200 Pixels
V total	1125 Lines
H active	1920 Pixels
V active	1080 Lines

- **Timing-V back porch** shows the size of the vertical Back Porch in pixels.

Checking SDI STATUS

NOTE: This parameter is available for SDI products.

- **Link type** shows link type of input SDI signal, including single link, dual link, quad link.
- **Link speed** shows the current data speed.
- **Stream type** shows the number of streams that is contained in the data source.
- **Level B** shows whether the input signal is level B format.
- **Interlaced** shows whether the input signal is interlaced.
- **Assignment** shows the link number, especially when be fed into a source of multi-link interfaces.
- **ST 352 payload ID** shows the SMPTE ST 352 video payload identification code for SDI.
- **H total** shows the total number of pixels, horizontally.
- **V total** shows the total number of pixels, vertically.
- **H active** shows the number of active pixels, horizontally.
- **V active** shows the number of active pixels, vertically.

INFO FRAME	
AVI	
Type	0x82
Version	0x02
Length	13 bytes
Checksum	0x07
Data	50 08 00 10 00 00 00 00 00 00 00 00
AUDIO	
Type	0x84
Version	0x01
Length	10 bytes
Checksum	0x70
Data	01 00 00 00 00 00 00 00 00 00

Checking INFO FRAME

NOTE: The parameters are available for products which support to input HDMI signals.

Checking AVI

- **Type** shows the packet type.
- **Version** shows the packet Version.
- **Length** shows the length of the AVI InfoFrame payload.
- **Checksum** shows the packet checksum.
- **Data** shows the InfoFrame payload.

INFO FRAME	
AVI	
Type	0x82
Version	0x02
Length	13 bytes
Checksum	0x07
Data	50 08 00 10 00 00 00 00 00 00 00 00
AUDIO	
Type	0x84
Version	0x01
Length	10 bytes
Checksum	0x70
Data	01 00 00 00 00 00 00 00 00 00

Checking AUDIO

- **Type** shows the packet type.
- **Version** shows the packet version.
- **Length** shows the length of audio InfoFrame payload.
- **Checksum** shows the packet checksum.
- **Data** shows the InfoFrame payload.

AUDIO	
Type	0x84
Version	0x01
Length	10 bytes
Checksum	0x70
Data	01 00 00 00 00 00 00 00 00 00

MW-SPD	
Type	0x83
Version	0x01
Length	25 bytes
Checksum	0x3E
Data	4D 53 46 54 00 00 00 00 58 62 6F 78 20 4F 6E 65 00 00 00 00 00 00 00 00 08

Checking MW-SPD

MW-SPD only displays when connecting a video game, like a PlayStation, or an Xbox.

- **Type** shows the packet type.
- **Version** shows the packet version.
- **Length** shows the length of source product description InfoFrame payload.
- **Checksum** shows the packet checksum.
- **Data** shows the InfoFrame payload.

Video

Click and enter **Video** tab to check the information detected by the device, and modify the video format according to your needs. By clicking **Reset to Default** in the bottom right corner of the page, you can cancel your modified settings.

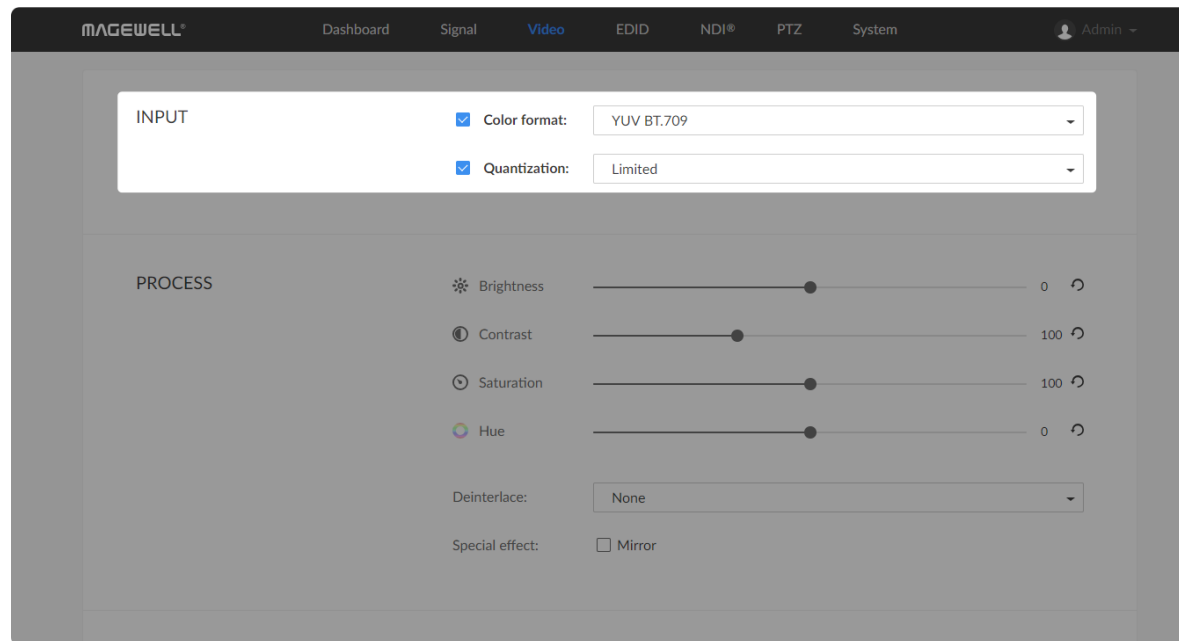



Setting INPUT Format

By default, **INPUT** shows the input information extracted from the signal. If a non-standard signal is incorrectly recognized by the device, you can manually adjust the parameters to correct it.

- **Color format**
Check the box to select other options, including RGB, YUV BT.601, YUV BT.709 and YUV BT.2020.
- **Quantization**
Check the box to select other options, including Full and Limited.

Setting PROCESS Format

By default, the video format of NDI streams is the same as that of input source. By clicking **Reset to Default** in the bottom right corner of the page, you can cancel your settings.

- **Brightness**
Drag the slider bars to adjust it. Click  to restore to default.
- **Contrast**
Drag the slider bars to adjust it. Click  to restore to default.
- **Saturation**

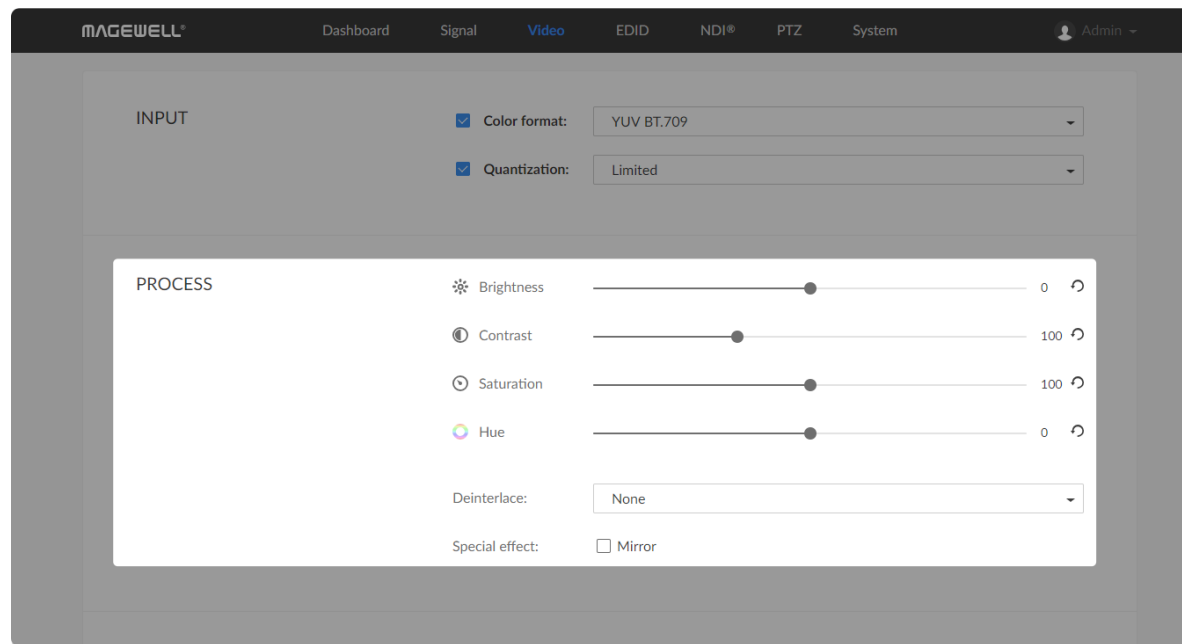

Drag the slider bars to adjust it. Click  to restore to default.

- **Hue**

Drag the slider bars to adjust it. Click  to restore to default.

- **Deinterlace**

Select other deinterlace options, including:

- None: an interlaced source will be encoded with both fields intact.
- Top field: Duplicate the upper field data vertically to create a full frame.
- Bottom field: Duplicate the lower field data to create a full frame.

- **Special effect**

Check the box to set a mirror effect (horizontal flip) of the video.

Setting OUTPUT Format

By default, the video format of the NDI output stream is the same as that of input source.

- **Resolution**

Follow input is the default. Select or customize your own resolution if necessary.

- **Frame rate**

Follow input is the default. Reduced rates are a Half, a Third or a Quarter of the input frame rate.

- **Full frame rate for low bandwidth**

If the low-bandwidth mode is enabled when using the NDI stream receiver application (such as Studio Monitor, Pro Convert decoder), user would preview/capture the video stream with low resolution and low frame rate,

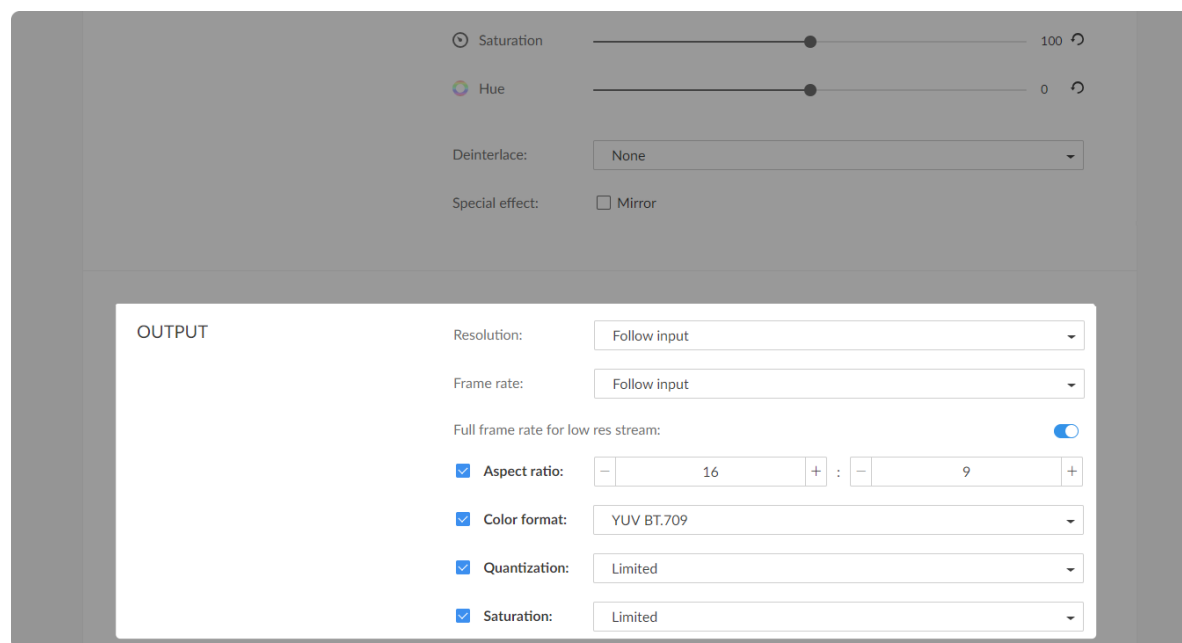

which greatly reduces the bandwidth requirement. At this time, if the Full frame rate for low res stream function is enabled, user can preview/capture a video at a low resolution but more smooth video. Since the frame rate is the same as that of the input signal but the bandwidth requirements is reduced. Turning this feature on without the low-bandwidth mode will not affect the video stream.

- **Aspect ratio**
Check the box to set a different aspect ratio, then select values for the ratio.
- **Color format**
Check the box to select other options, including: YUV BT.601, YUV BT.709, YUV BT.2020.
- **Quantization**
Check the box to select other options, including: Full, Limited.
- **Saturation**
Check the box to select other options, including: Full, Limited, Extended.

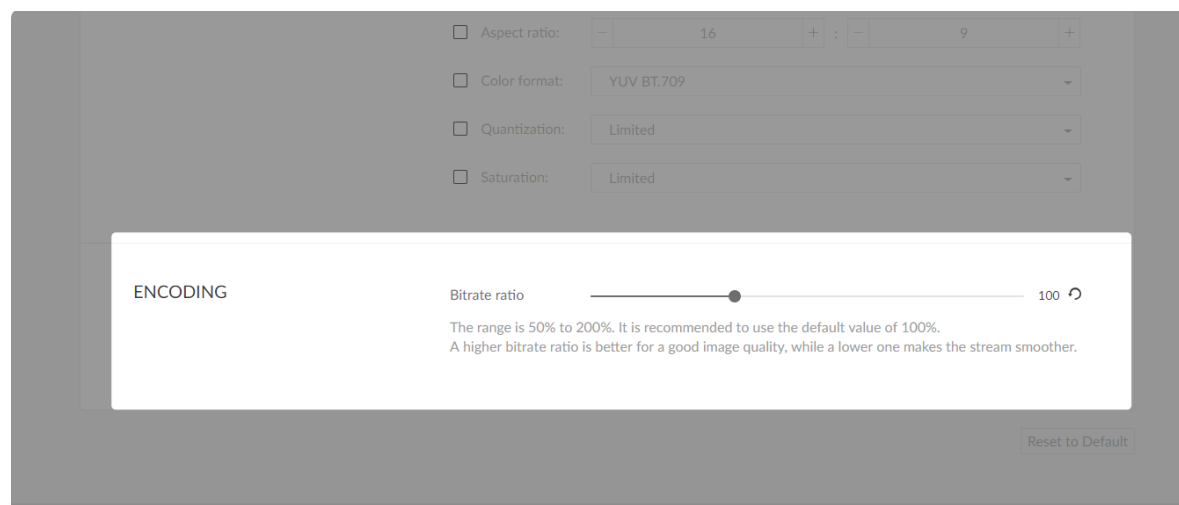

Setting Encoding Bitrate Ratio

The range of bitrate ratio is 50% to 200%. It is recommended to use the default value of 100%.

A higher bitrate ratio is better for a good image quality and requires higher bandwidth, while a lower one might lead to less satisfactory image quality but require lower bandwidth.

EDID

Click and enter the **EDID** tab to check the EDID information. By clicking **Reset to Default** in the bottom right corner of the page, you can cancel your settings. This tab is only available for HDMI products.

The screenshot shows the MAGEWELL EDID configuration page. The 'INPUT PORT' section has a table with the following data:

Offset	0	1	2	3	4	5	6	7	8	9	A	B	C	D	E	F
00	00	FF	FF	FF	FF	FF	FF	00	34	F7	01	00	01	00	00	00
10	01	1A	01	03	80	00	00	78	02	EE	95	A3	54	4C	99	26
20	0F	50	54	FF	FF	80	31	40	45	40	61	40	71	40	81	80
30	D1	00	E1	C0	01	00	08	E8	00	30	F2	70	5A	80	80	58
40	8A	00	50	1D	74	00	00	1E	02	3A	80	18	71	38	2D	40
50	58	2C	45	00	50	1D	74	00	00	1E	00	00	00	FD	00	0F
60	96	0F	87	3C	00	00	00	00	00	00	00	00	00	00	00	FC
70	00	40	41	47	45	57	45	4C	4C	0A	20	20	20	20	01	66
80	02	03	51	F1	57	61	10	1F	04	13	05	14	20	21	22	5D
90	5E	5F	60	65	66	62	63	64	07	16	03	12	32	09	7F	07
A0	15	07	50	3D	06	C0	57	06	00	5F	7F	01	67	7F	00	83
B0	4F	00	00	E2	00	0F	6E	03	0C	00	10	00	88	78	21	10
C0	80	01	02	03	04	67	D8	5D	C4	01	78	80	03	E3	0F	01

The 'OUTPUT PORT' section has a table with the following data:

Offset	0	1	2	3	4	5	6	7	8	9	A	B	C	D	E	F
00	--	--	--	--	--	--	--	--	--	--	--	--	--	--	--	--
10	--	--	--	--	--	--	--	--	--	--	--	--	--	--	--	--
20	--	--	--	--	--	--	--	--	--	--	--	--	--	--	--	--
30	--	--	--	--	--	--	--	--	--	--	--	--	--	--	--	--

Setting SmartEDID™

NOTE: This function is available for Pro Convert HDMI Plus/4K Plus products.

SmartEDID™

- SmartEDID™ is enabled by default. When it is disabled, other related functions can not be set.
- Depending on the input capability of the converter and that of the device connected to the loop-through interface, the converter will smartly select to send the EDID to the video source device, to ensure both the converter and the loop-through device can obtain the signal they support.

Keep last

- Keep the last EDID value used.
- This function is disabled by default. To enable it, the SmartEDID function should also be enabled. When Keep Last is enabled and the loop-through device is disconnected, the current EDID will still be used. The converter will continue receiving signal so the video capture and encoding continues. Otherwise, the converter will resend its EDID to the source device for it to redetermine what format of signal to send. As a result, there could be an interruption to the source signal for a short time.

- **Add audio**

- Force the source device to output audio.
- If users connect a monitor which doesn't support audio to the loop-through output, the source device will decide not to output audio. As a result, the Pro Convert will not get any audio input. If **Add Audio** is enabled, the Pro Convert will communicate with the video source device, forcing it to output audio.

- **Limited pixel clock**

- If enabled, when the pixel resolution of the loop-through device is beyond the capability of the Pro Convert, a lower pixel resolution will be used in order to avoid the output producing a blank screen.

Setting INPUT EDID

Any of the following actions can be performed on the input EDID of the device.

- **Default:** Click **Default** to reset the current EDID to default values.
- **Import:** Click and select an EDID file to import a local EDID file.
- **Export:** Click and set the file name to export the current EDID as a .bin file.

Settings for the EDID of the converter.
SmartEDID™ solves conflicts when connecting a loop-through device.

Offset	0	1	2	3	4	5	6	7	8	9	A	B	C	D	E	F
00	00	FF	FF	FF	FF	FF	FF	00	34	F7	00	D1	4E	61	BC	00
10	01	14	01	03	80	30	18	78	0F	EE	95	A3	54	4C	99	26
20	0F	50	54	FF	FF	80	81	00	81	40	81	80	95	00	A9	40
30	B3	00	D1	00	D1	40	E2	68	00	A0	A0	40	2E	60	30	20
40	36	00	C4	8E	21	00	00	1A	28	3C	80	A0	70	B0	23	40
50	30	20	36	00	C4	8E	21	00	00	1A	00	00	00	FC	00	58
60	49	31	30	30	44	45	20	34	4B	0A	20	20	00	00	00	FD
70	00	19	78	0C	FF	1E	00	00	00	00	00	00	00	00	01	4B
80	02	03	32	71	4F	06	15	02	11	13	04	14	05	20	21	22
90	1F	10	40	3F	26	0F	7F	07	09	7F	07	83	2F	00	00	72
A0	03	0C	00	20	00	88	3C	20	C0	84	01	02	03	04	01	41
B0	FF	FF	04	74	00	30	F2	70	5A	80	B0	58	8A	00	C4	8E
C0	21	00	00	1E	00	00	00	00	00	00	00	00	00	00	00	00

Default Import... Export...

OUTPUT PORT
Settings for the EDID obtained from the device which output port is connected to.

Offset	0	1	2	3	4	5	6	7	8	9	A	B	C	D	E	F
00	00	FF	FF	FF	FF	FF	FF	00	34	F7	00	E1	4E	61	BC	00
10	01	19	01	03	80	30	18	78	07	EE	95	A3	54	4C	99	26
20	0F	50	54	FF	FF	80	81	C0	81	00	81	40	95	00	A9	40
30	B3	00	D1	C0	D1	00	F3	39	80	18	71	38	2D	40	58	2C
40	45	00	C4	8E	21	00	00	1A	28	3C	80	A0	70	B0	23	40
50	30	20	36	00	C4	8E	21	00	00	1E	00	00	00	FC	00	50
60	72	6F	20	43	61	70	74	75	72	65	0A	20	00	00	00	FD
70	00	19	78	0C	78	11	00	0A	20	20	20	20	20	20	01	D4
80	02	03	2F	71	50	01	02	03	04	05	90	11	12	13	14	1F
90	20	21	22	06	15	26	0F	7F	07	09	7F	07	83	2F	00	00
A0	6E	03	0C	00	20	00	F8	2D	20	C0	04	01	41	FF	FF	F3
B0	39	80	18	71	38	2D	40	58	2C	45	00	C4	8E	21	00	00
C0	00	00	00	00	00	00	00	00	00	00	00	00	00	00	00	00

Export...

Checking OUTPUT EDID

OUTPUT EDID shows the EDID of the connected loop-through device.

NOTE: This section is not available for TX products.

- **Export:** Click and set the file name to export the current EDID as a .bin file.

NDI®

NDI® is a standard developed by NewTek to transport IP video over a LAN with high-quality and low latency. Note that you need to click **Apply** at the bottom-right corner of the page to save changes.

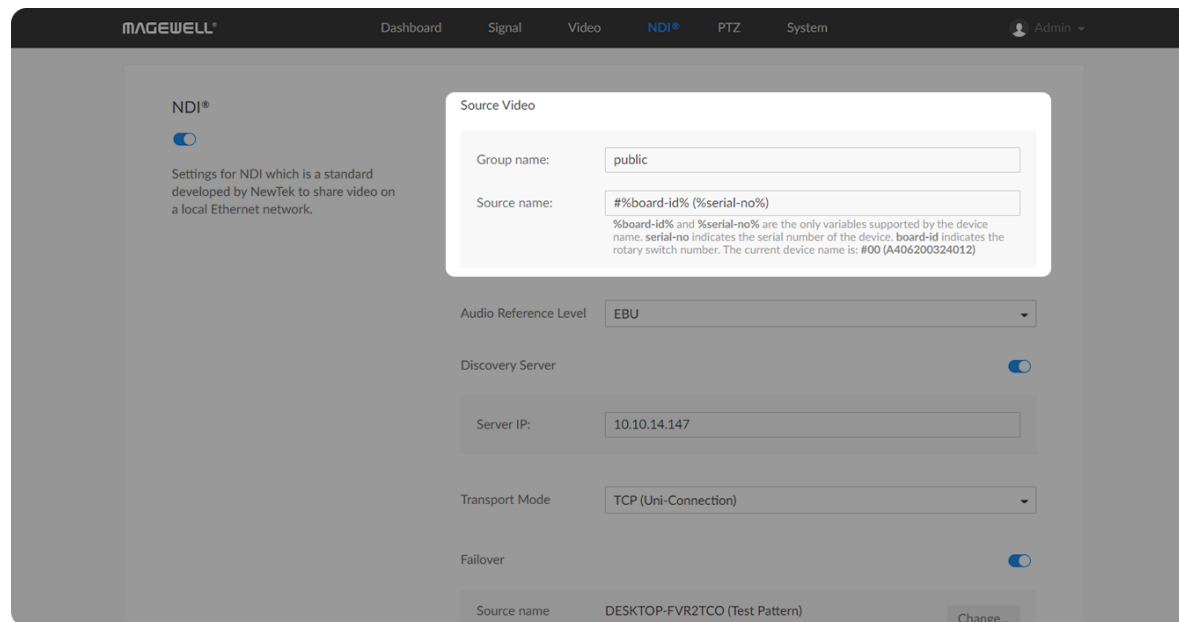

Figure1. Set Source Video parameters in the Web UI

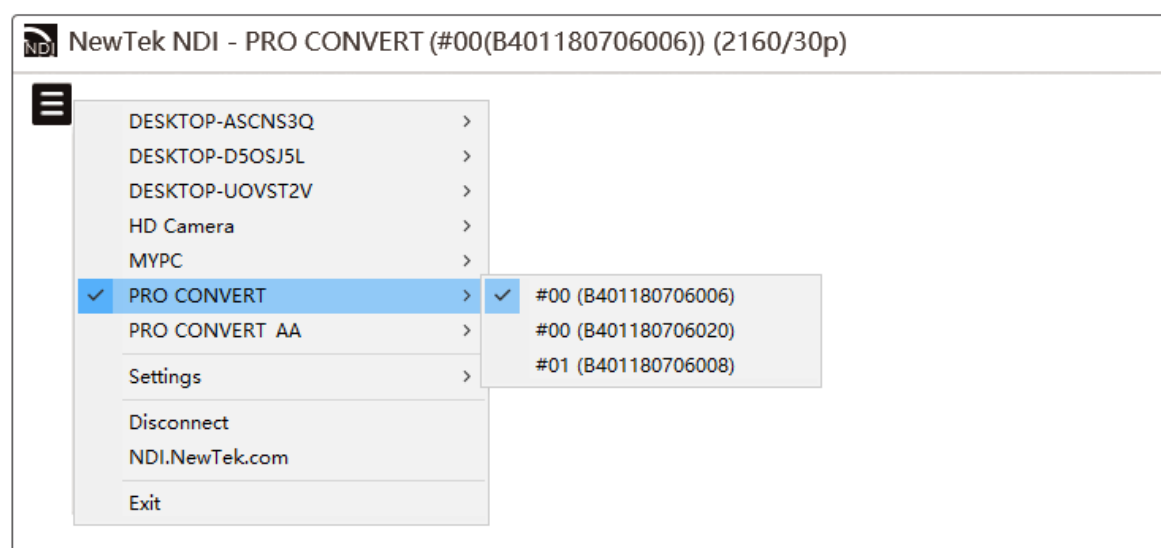
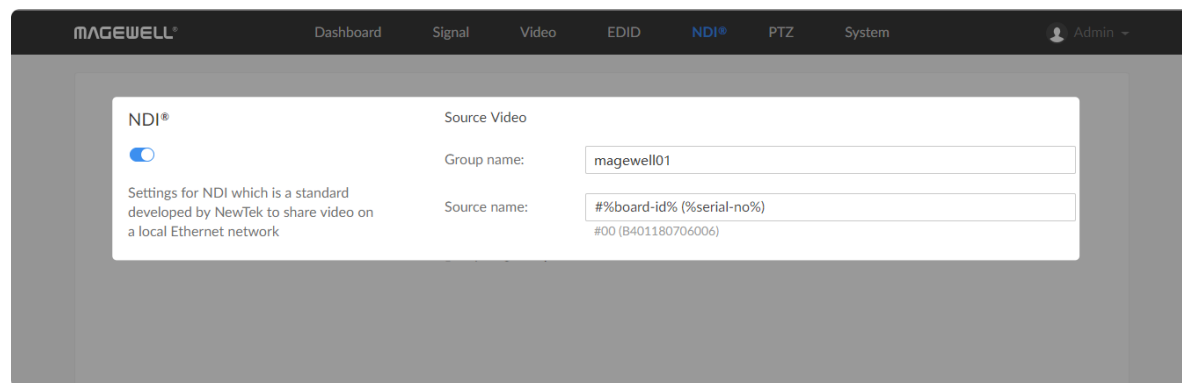

Figure2. Monitor Pro Convert devices using NDI Studio Monitor

Setting Source Video

- **Group name** shows the group that receives NDI streams sent by your converter.
 - The group name is non case-sensitive, and should contain A to Z, a to z, 0 to 9 and special characters like `_`. The group name entry can contain comma-separated values, allowing your converter to send to all the groups listed here.
 - The default group is **public** group.
 - To make a private NDI group, refer to [Creating a Private Group](#).
- **Source name** shows the NDI source name used for your converter.
 - By default, the source name is `##board-id% (%serial-no%)`. when you monitor Pro Convert devices using NDI Studio Monitor, the NDI stream name is displayed as on the left in Figure2.
 - You can change the **board-id** via the rotary switch on your unit.
 - **serial-no** indicates the unit's serial number, as per the barcode label.
 - `%board-id%` and `%serial-no%` are the only supported variables.
 - You can change the Source Name to a string with maximum of 30 characters, containing A to Z, a to z, 0 to 9, spaces and special characters like `_-#()`.
 - If no text is entered for the Source Name, it will take the default value



#%board-id% (%serial-no%) automatically after clicking **Apply**.

How to create a private NDI Group

By default, all NDI channels are in the **public** group, visible to all NDI clients on the same LAN. Here's a walkthrough of the basics for creating and joining private groups.

1. Creating a Private Group In Web UI

- Step 1** Access the Web UI, and sign in with your account. Then click and enter the **NDI®** tab.
- Step 2** Change the **Group name**. Here for example, magewell01.
A converter is allowed to send streams to multiple groups when setting the **Group name** as comma-separated values, such as "magewell01,magewell02,magewell03,magewell04".
- Step 3** Click **Apply** to save your changes.
Now, any NDI-enabled clients of groups magewell01, magewell02, magewell03, or magewell04 can receive video streams sent by your converter on the same LAN.

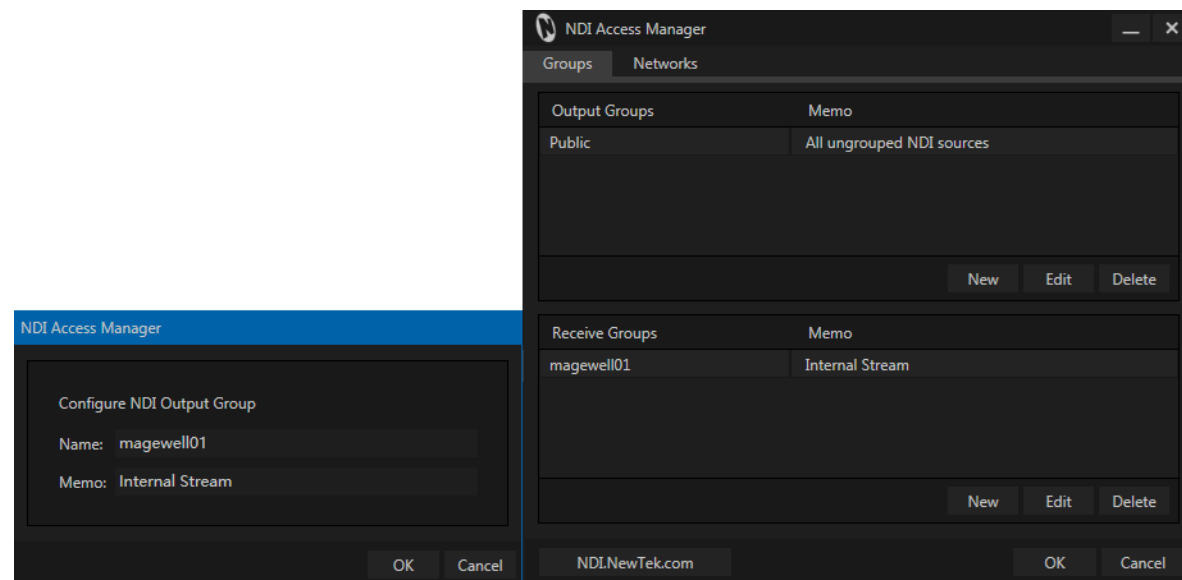

2. Joining In the Private Group In NDI Access Manager

- Step 4** Download and install the **NDI tools** from the NewTek official site www.newtek.com/ndi/tools for free.
- Step 5** Launch the **NDI Access Manager** in your system.
- Step 6** Click **New** in **Receive Groups** section in the **Groups** tab, and add the same group that was created in the Pro Convert Web UI. Here for example, magewell01.
- Step 7** Click **OK**.

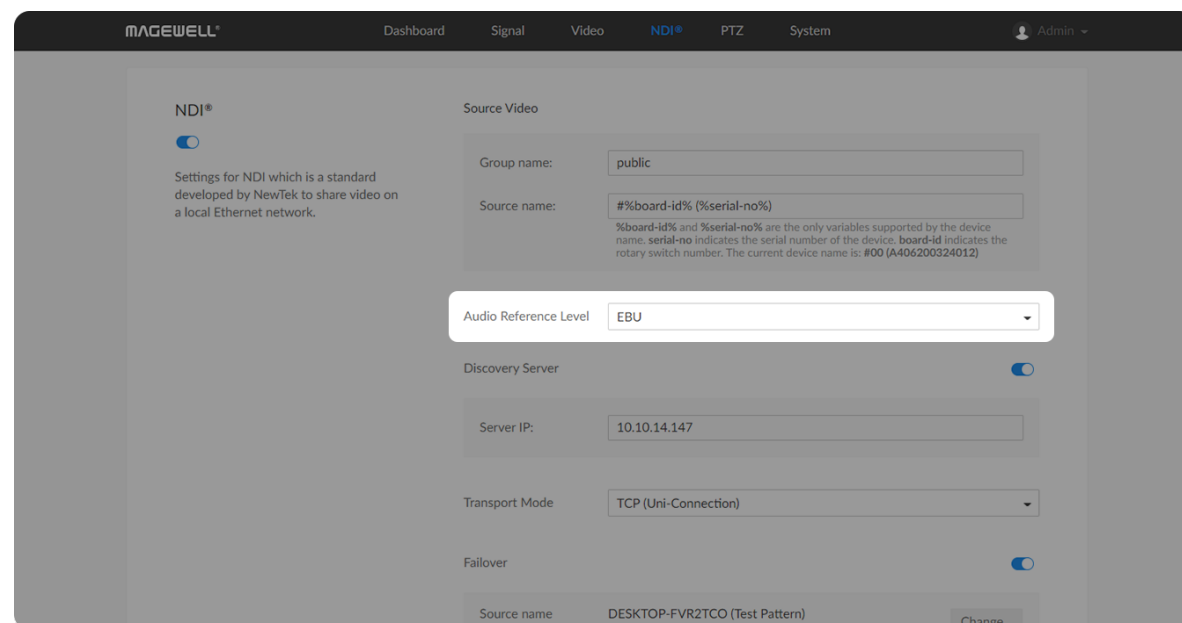

Setting Audio Reference Level

Two ways are provided for audio values conversion between source and output signal including **EBU** and **SMPTE**. By default, it is **SMPTE**.

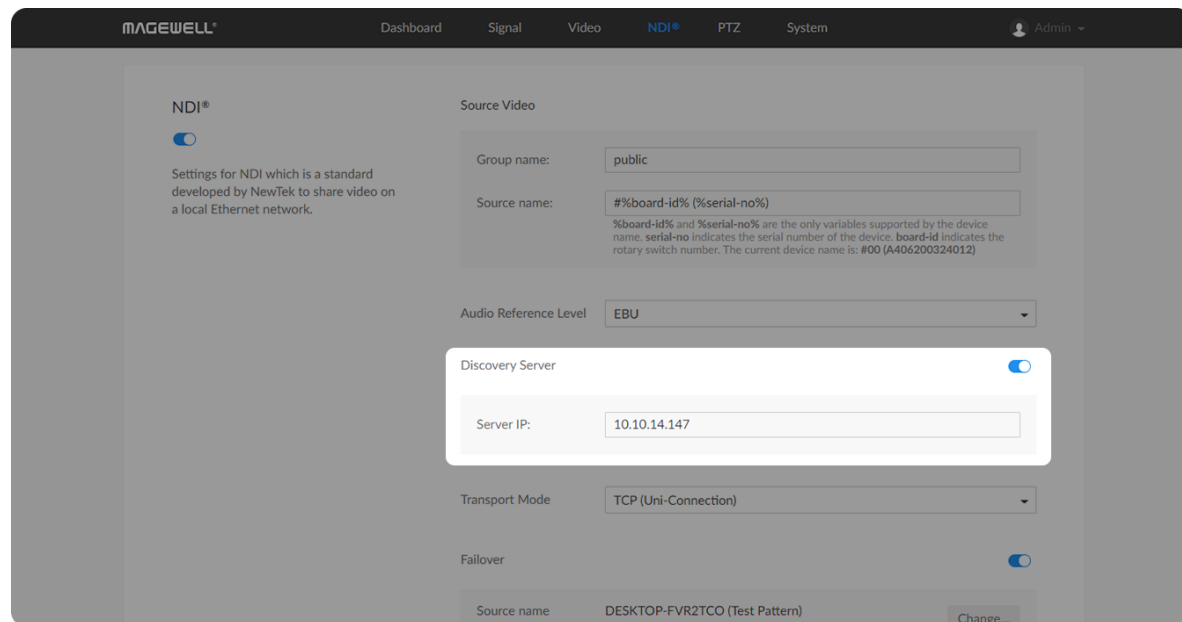

Figure 1 Set discovery server in the Web UI

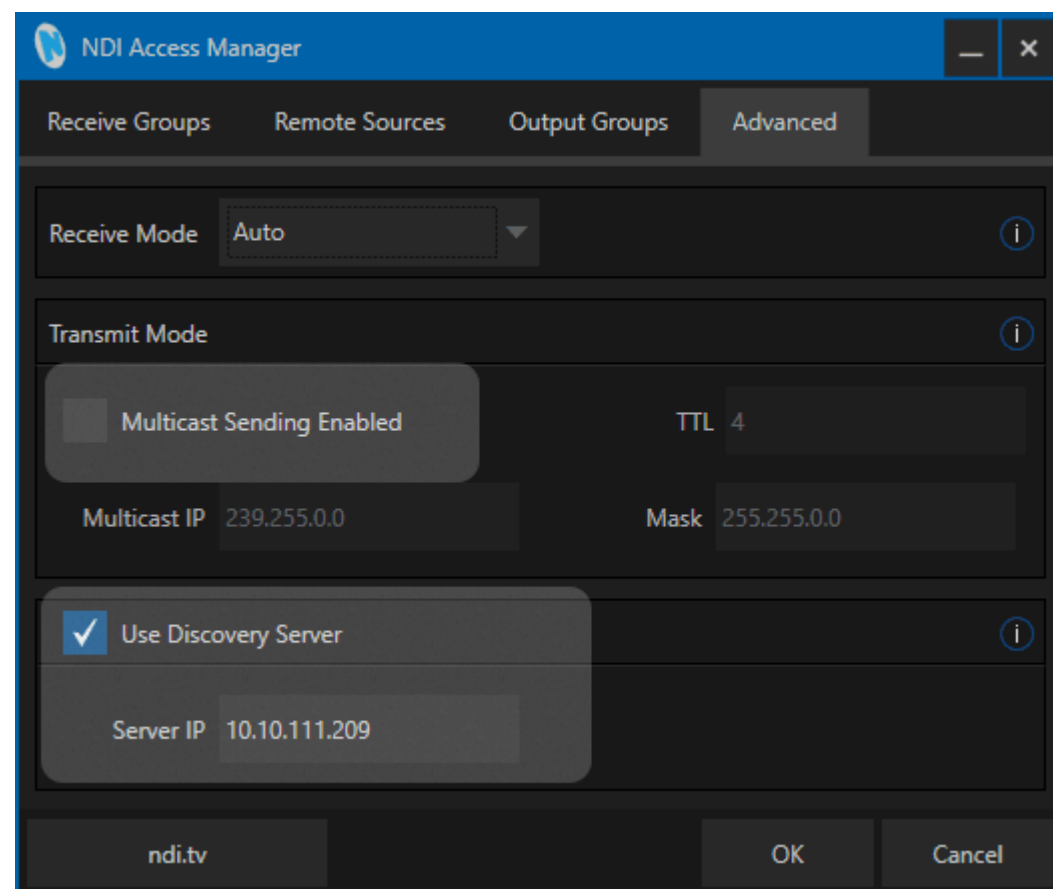

Figure 2 Set discovery server in the NDI Access Manager tool

Setting Discovery Server

By turning on the **Discovery server**, the encoder can only be received by the specified receiver, and the mDNS auto-discovery function is unavailable.

Pro Convert encoder can be used as a discovery server due to the build-in Discovery Service feature. It starts automatically when device booting, and requires zero configuration. Or you can deploy NDI Discovery Service on another server considering your studio environment.

1. Ensure that the receiver and encoder can ping each other.
This function works between encoder and receiver that can ping each other even from differential network segment. After setting, the output stream of your encoder can be received by specified server.
2. Use Pro Convert encoder as the Discovery Server: in the encoder WebUI, enable **Discovery server**, and specify the **Server IP** to IP address of the Pro Convert encoder.
3. Launch the **NDI Access Manager** tool installed in the receive computer, and specify the discovery server parameters.
 - i. Enter the **Advanced** tab.
 - ii. Disable **Multicast Sending Enabled**, check **Use Discovery Server**, and specify **Server IP** to the IP address of the receiver server running discovery service function.
Note: The **Server IP** of NDI Access Manager and encoder WebUI should be the same.

Download the **NDI Access Manager** from the NewTek official site www.newtek.com/ndi/tools for free.

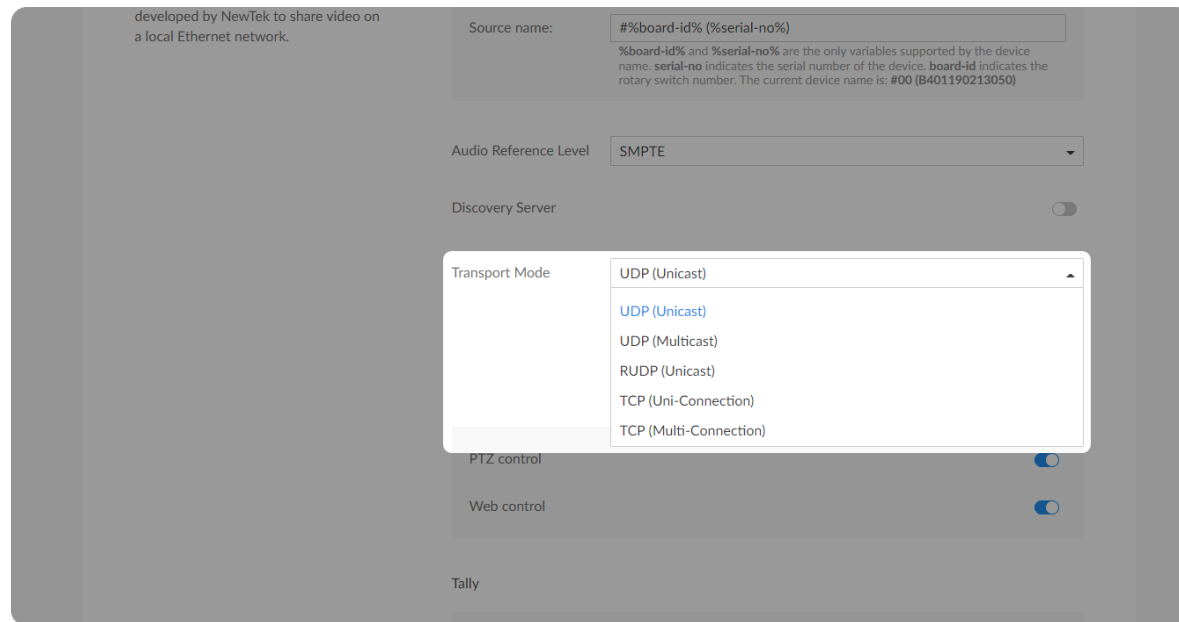

Setting Transport Mode

Connections can be established between the encoder and their receivers, including UDP (Unicast), UDP (Multicast), RUDP (Unicast), TCP (Uni-Connection) and TCP (Multi-Connection). Choose a proper one based on your networking conditions. By default, TCP (Multi-Connection) is used.

- **UDP (Unicast)** indicates that the encoder sends a UDP stream directly to the receiver. It is used where lower latency matters. And multiple simultaneous streams will work independently for multiple receivers.
- **UDP (Multicast)** indicates that the encoder sends the UDP stream to a multicast group. It is used for one-to-many broadcast for lower CPU utilization. Parameters in a multicast configuration include:
 - **Multicast IP** ranges from 224.0.0.0 to 239.255.255.255.
 - **Subnet Mask** can be legitimate value ranging from 255.0.0.0 ~ 255.255.255.252.
 - **Time To Live** ranges from 1 to 255. The default value is 4.
- **RUDP (Unicast)**, Reliable User Datagram Protocol, is a connection-oriented and unicast protocol. RUDP helps to maintain the flow control and reliability of data transfer. The transmission control algorithms on both sending and receiving sides guarantee the RUDP capable of recovering from data loss, duplication, delay, and as well as reordering.
- **TCP (Uni-Connection)** indicates to establish single TCP connection between the encoder and receiver, and transfer all A/V packets are transferred via one port. Compared with UDP (Unicast) or TCP (Multi-Connection), it has lower CPU utilization. It is used where reliable transmission of data matters, which makes it suitable for 4K NDI streams.
- **TCP (Multi-Connection)** indicates to establish multiple TCP connections

between the encoder and receivers, but transfer audio packet and video packet via different ports. It usually works in a complicated networking studio. It is used where reliable transmission of data matters, which makes it suitable for 4K NDI streams.

Setting Failover

Failover is a method of protecting your NDI transmission from failure. If the source video fails, the backup device begins to provide a service. The initial source will be restored after it recovers. This function is disabled by default.

- **Source name** shows the backup NDI channel name. Click **Change...** and select the failover (backup) video device within the same NDI group as the initial source.
- **IP Address** shows the IP Address of the backup NDI channel. The failover IP Address is automatically obtained after you select the backup NDI source.

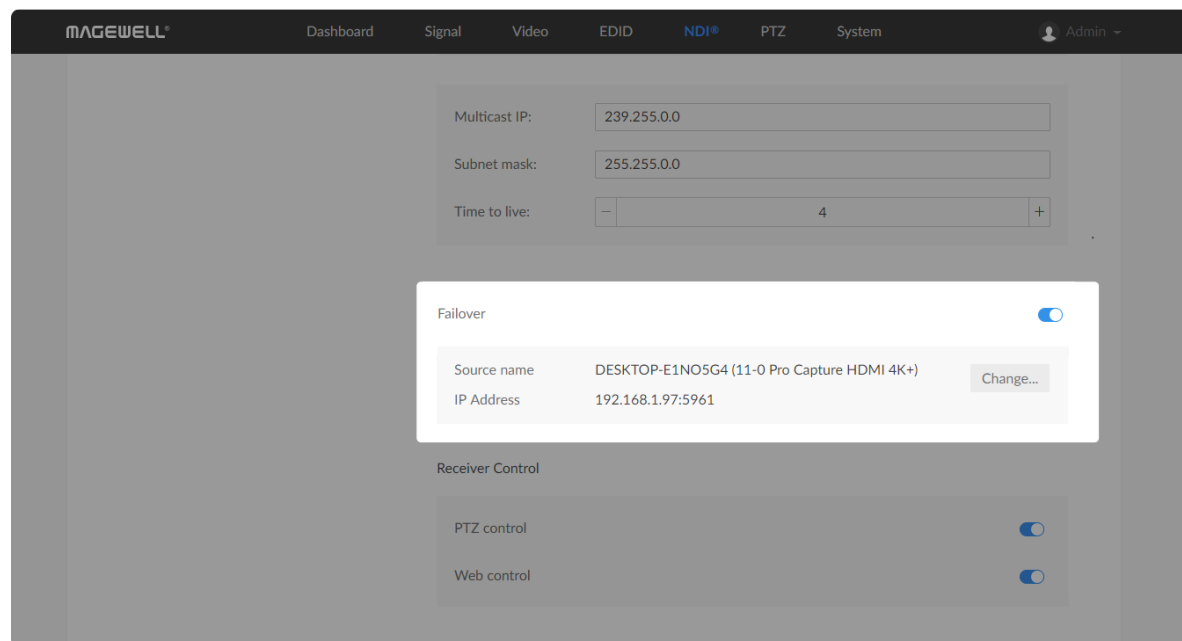

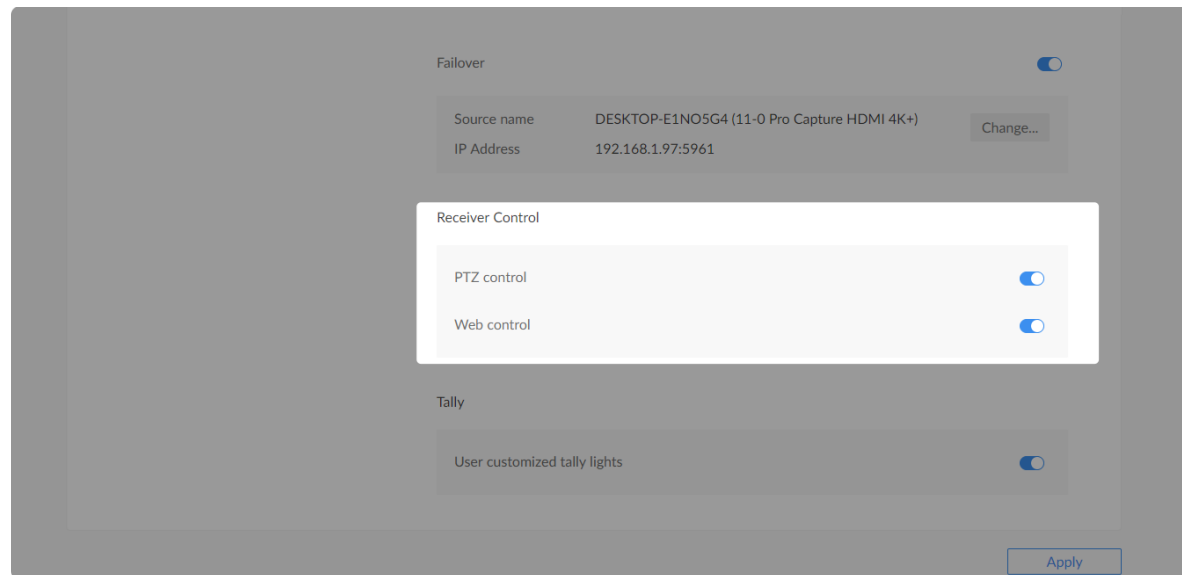

Figure1. Set Receiver Control parameters in the Web UI

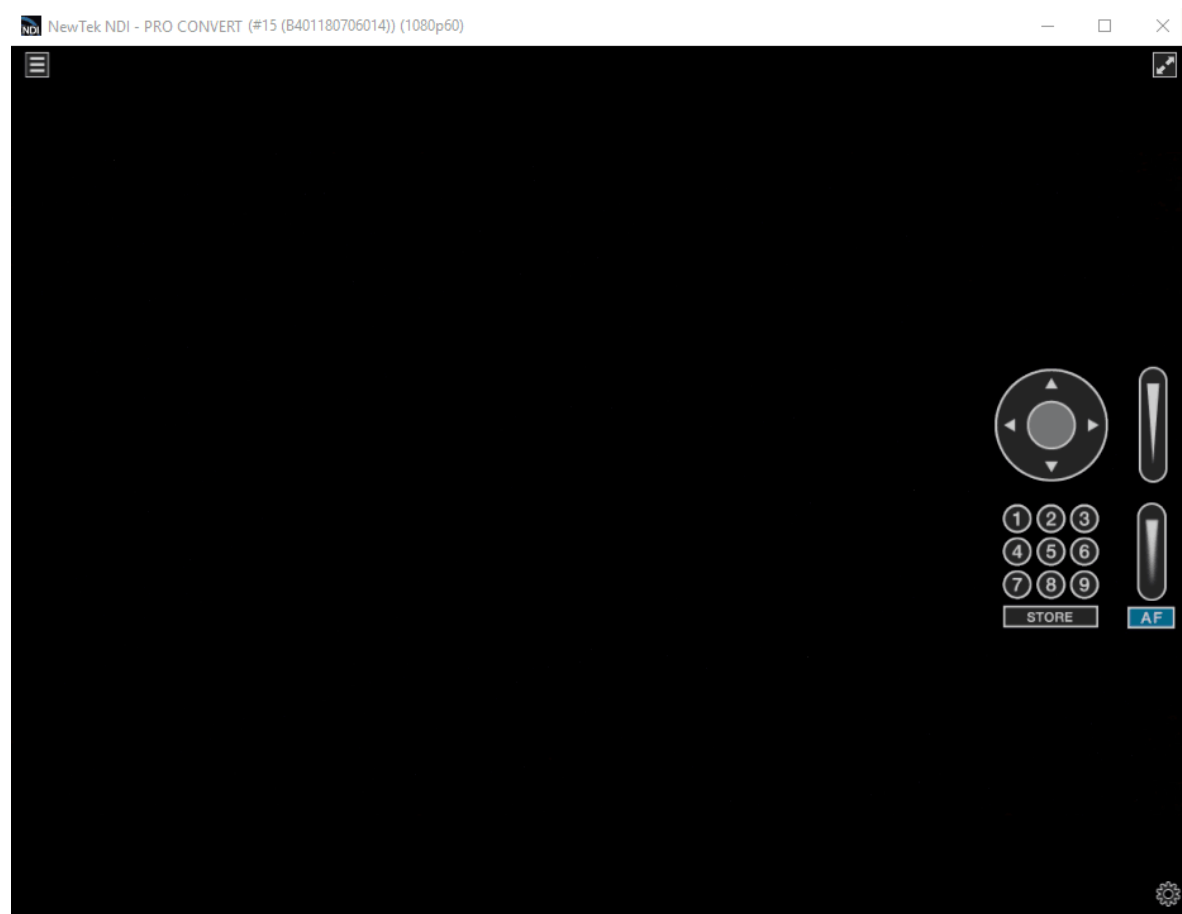

Figure2. NDI Studio Monitor: PTZ controller

Setting Receiver Control

- **PTZ control**

This function is disabled by default. Turn it on when you want to control a connected PTZ camera through the **NDI Studio Monitor**, then the PTZ controller interface will be shown in the NDI Studio Monitor.

- **Web control**

This function is enabled by default. We recommend you keep it turned on, because you cannot open the Web UI by clicking the gear icon in the NDI Studio Monitor if this function is disabled.

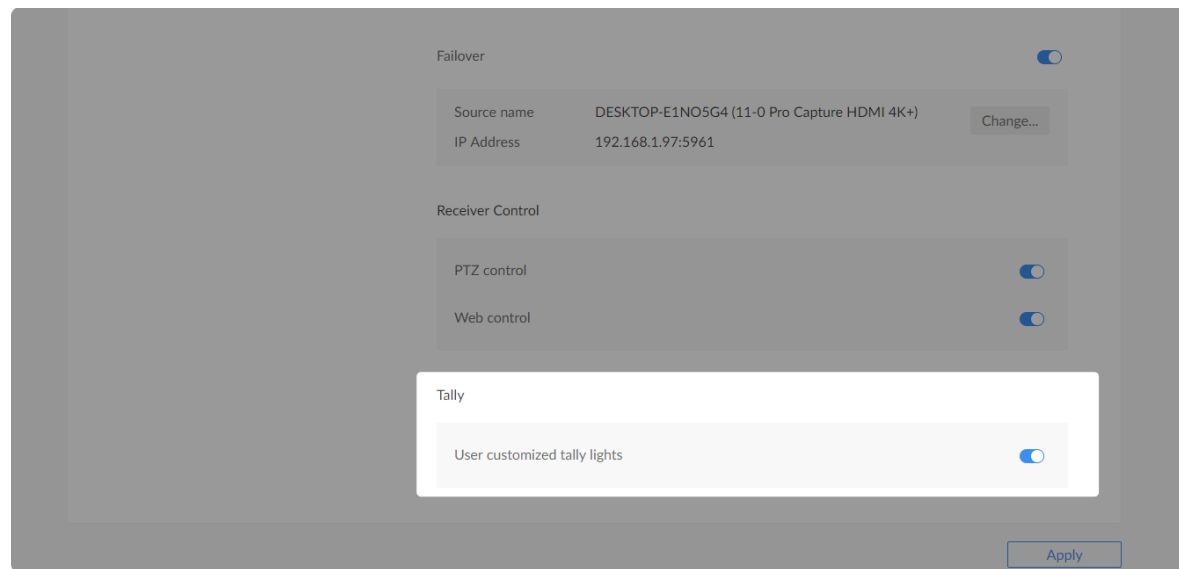

Using Custom Tally Lights

Pro Convert™ supports the use of **User customized tally lights** through the definition of the pinouts of the PTZ interface.

Note that the second you turn on the switch for this function, the Magewell tally light and LED matrix screen will no longer be working. The pinouts of the PTZ interface see [Description of Mini-DIN8 Breakout](#).

PTZ

Pro Convert supports control of multiple PTZ cameras through the 8-pin PTZ control socket. Wire PTZ cameras in a daisy chain if you want to control multiple cameras. Click and enter the **PTZ** tab to set parameters.

Note:

- If installing more than one PTZ camera, you need to make sure that all cameras are set to the same protocol ("VISCA"), the same Baud Rate, and are connected in serial mode.
- If the V addresses of the cameras are set to fixed, the IDs must be different for the converter to determine their identities.
- If the V address are not fixed, the converter will assign an ID for the PTZ camera automatically. If multiple cameras are connected, the directly connected one is Device 1, the next one in the chain is Device 2, etc.
- Check your camera manual for instructions on how to set up your PTZ cameras.

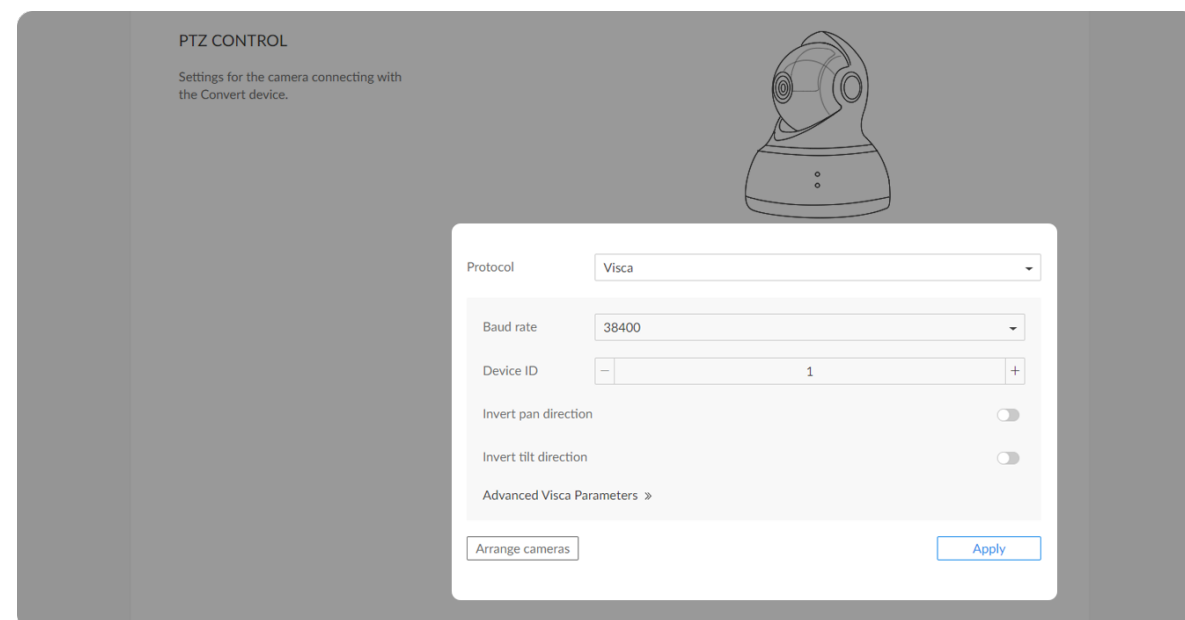

Setting PTZ Control Parameters

- **Protocol**
Shows the control language that allows the camera and the converter to communicate to each other. For now, **VISCA**, **Visca UDP**, **Visca UDP2rs232**, **PELCO-P** and **PELCO-D** protocol are supported. If multiple cameras are connected, all cameras should also be set to **VISCA**.
- **Baud rate**
Shows the control data speed. For example, "9600 baud" means that the PTZ control port is capable of transferring a maximum of 9600 bits per second. If multiple cameras are connected, each camera should be set to the same value as used here.
Options are: 2400, 4800, 9600, 19200 and 38400.
By default, the Baud rate is 9600.

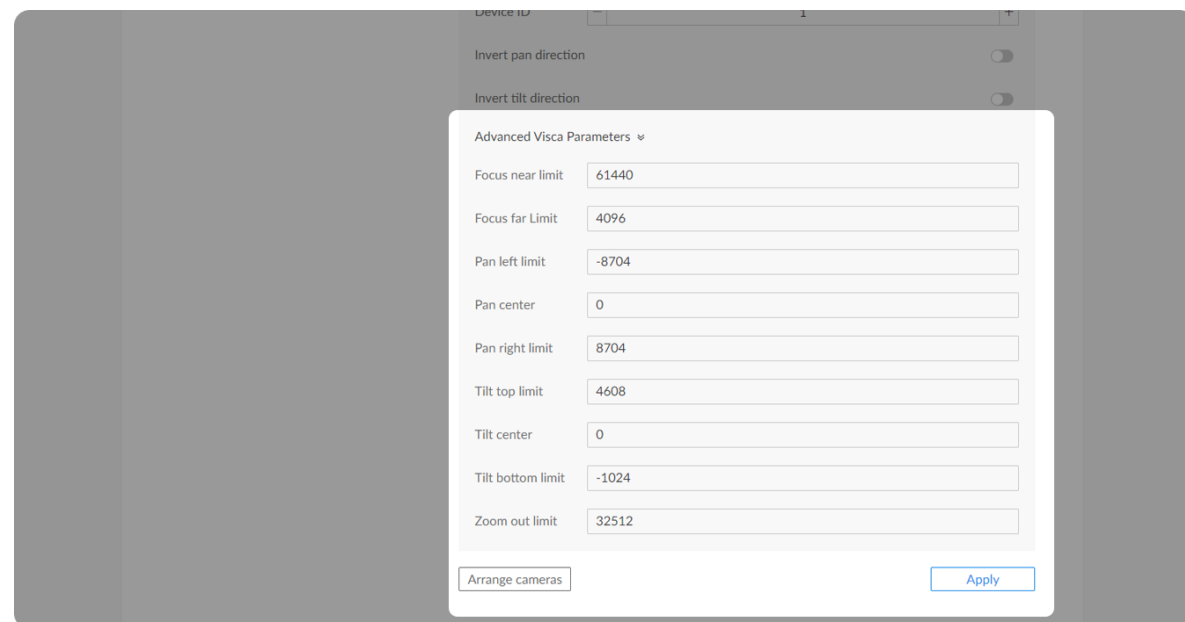

- **Device ID**

Shows the ID of the camera, which allows the controller to identify different PTZ cameras, especially when multiple cameras are connected.

The value ranges from 1 to 7.

By default, the value is 1.

- **Invert pan direction**

Turn on to reverse the pan-direction movement. You can enable this function to make control more intuitive when the camera is not installed in the normal position.

- **Invert tilt direction**

Turn on to reverse the tilt-direction movement. You can enable this function to make control more intuitive when the camera is not installed in the normal position.

- **Advanced Visca Parameters**

Pro Convert device supports advanced control of the PTZ camera when using **VISCA** or **Visca UDP**. Note the following points when configuration.

1. Check the user manual of the camera or contact the manufacturer for detailed control parameters of the camera.
2. Convert the values of camera parameters to decimal numbers and fill them in the corresponding parameter options.

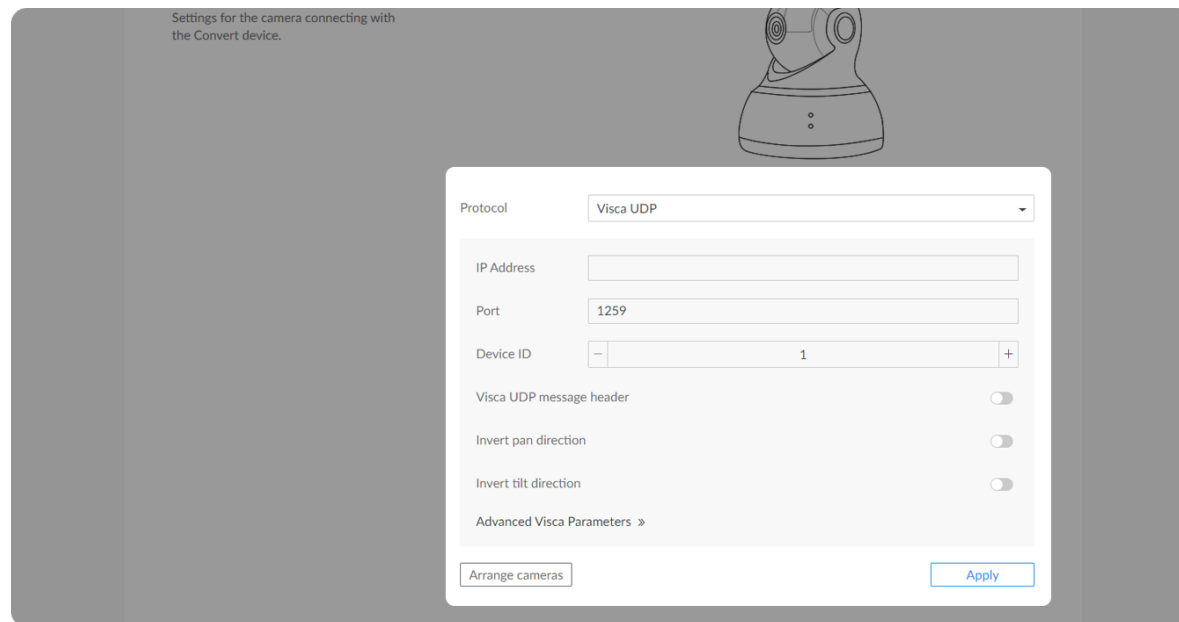

- **Control the PTZ camera via Visca UDP**

Pro Convert device supports control of the network camera via the Visca UDP protocol, without the need to use a PTZ control line to connect the Pro Convert device to the PTZ camera. The PTZ camera and encoder must be able to ping each other.

Set the encoder parameters as follows.

1. **Protocol:** Visca UDP
2. **IP Address:** The IP address of your camera
3. **Port:** Your camera's Visca protocol network port (check the user manual of the camera or contact the manufacturer to get it)
4. **Visca UDP message header:** Turn this option on if the communication protocol your camera (e.g. SONY camera) uses the Visca UDP header. Or else, the converter may not be able to control the PTZ camera.

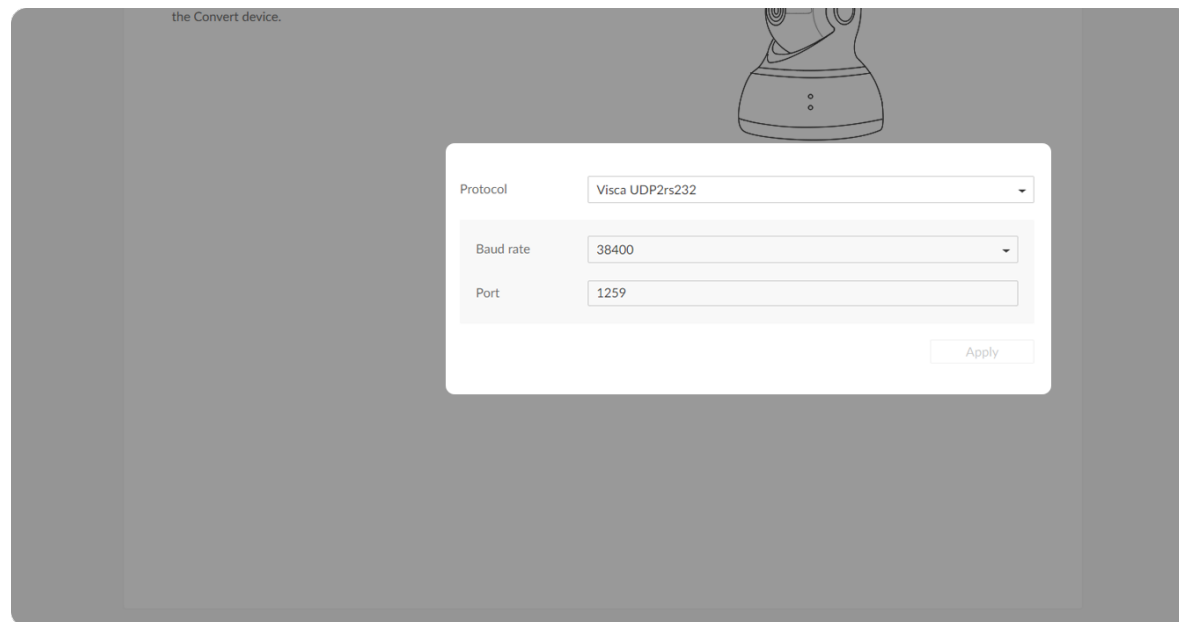

Figure1 Parameters of the encoder

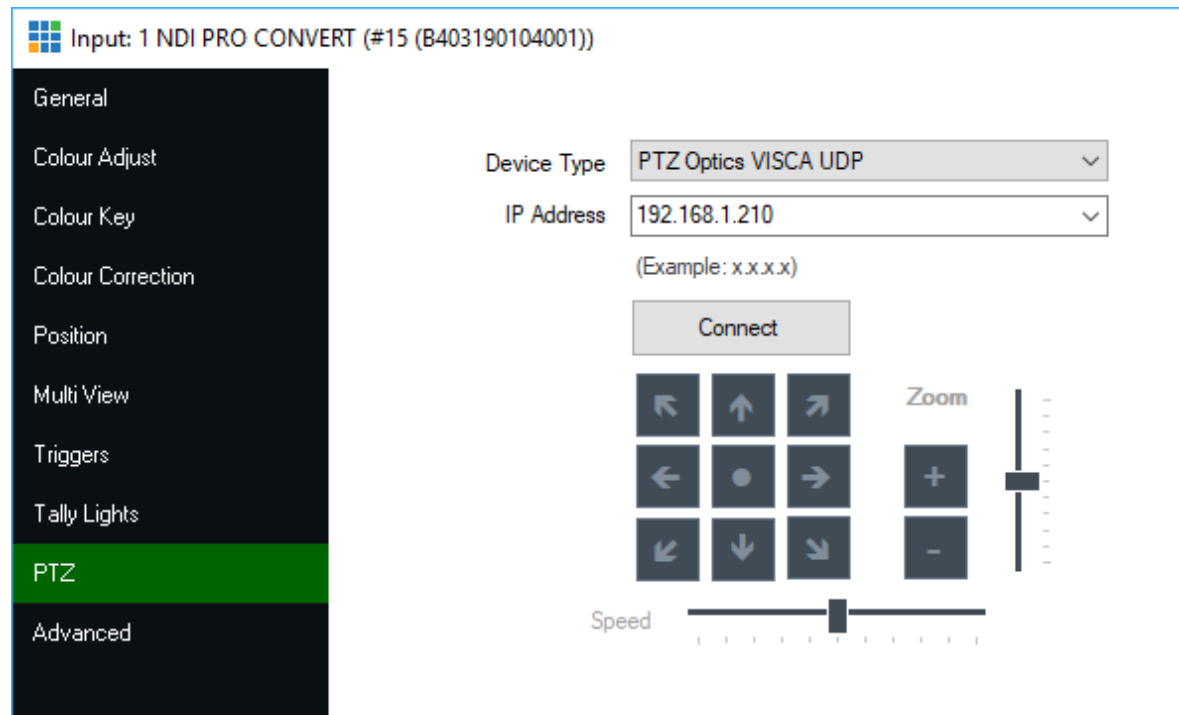

Figure2 Parameters of the vMix PTZ

- Control the PTZ camera via Visca UDP2rs232

Use the protocol When a capture software (e.g. vMix) supports PTZ but not NDI PTZ. Set the PTZ parameters of the encoder, PTZ camera and capture software as follows.

1. Connect the encoder to the RS232 IN port on the PTZ camera.
2. Encoder protocol: Visca UDP2rs232.
The **Port** number of the encoder should be the same as that of the vMix protocol port number.
3. PTZ camera protocol: Visca
4. In the capture software, use Visca UDP or Visca over IP to control PTZ and fill in with the IP address of the encoder. The configuration example of vMix is shown as the left figures.

System

With administrative rights, you can access the **System** tab to control more functions, such as:

- Creating or removing general user accounts for accessing the converter
- Changing passwords for all users of the converter
- Changing the converter's name
- Network settings for joining a specific LAN
- Updating firmware for the latest features and improvements
- Joining Magewell Cloud for remote control
- Exporting reports and logs to get technical support
- Rebooting or resetting the converter to fix problems

Otherwise, the **System** tab is invisible when you log in as a general user.

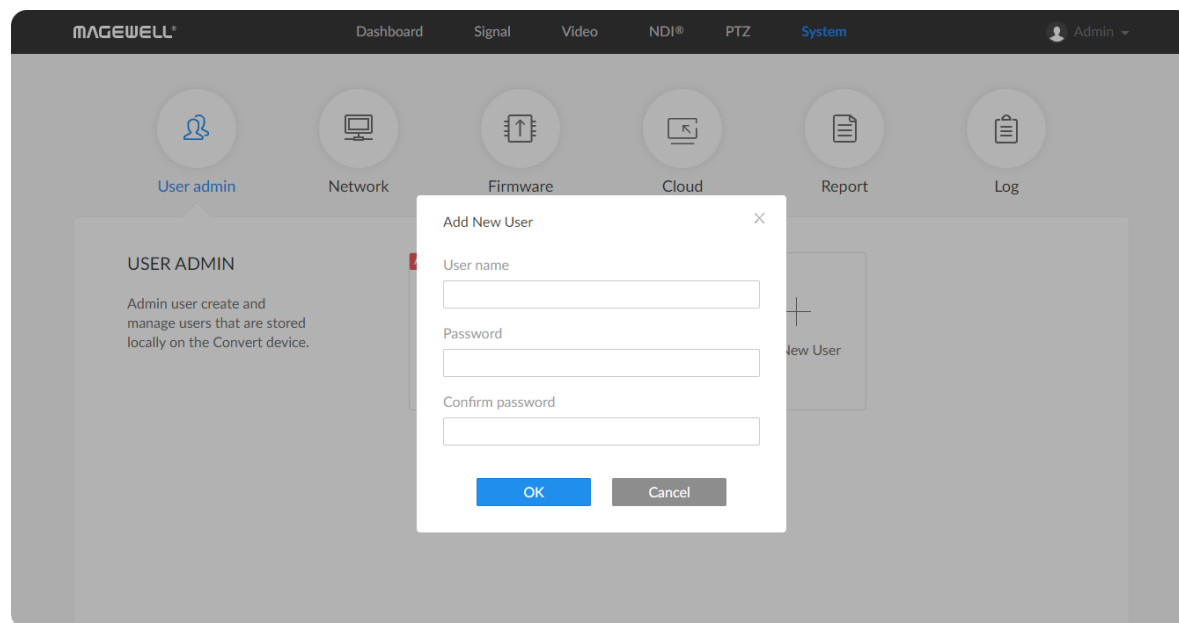

Creating/Removing General Users

After signing in with default admin account, you may need to add general users to give them permissions to do basic operations, like monitoring the device, or setting some of the parameters.

Step 1 Access the Web UI, and sign in as administrator.

Step 2 Click and enter the **System > User Management** tab.

Step 3 Click **Add New User**.

Step 4 Type in the user name, password, and confirm your password.

- The username is a string of 3 to 12 characters, which contains the letters A-Z, a-z, numbers 0-9 and underscore.
- The password is a string of 1 to 32 characters, which contains the

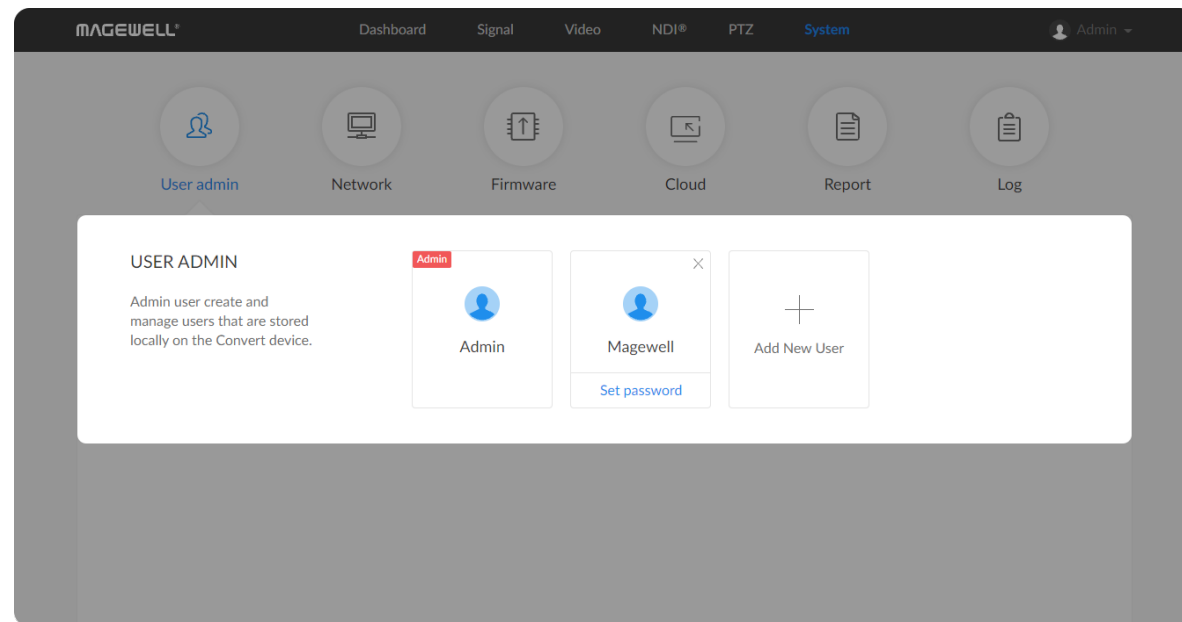

letters A-Z, a-z, numbers 0-9 and special characters _-~!@#\$%^&*~+=.

Step 5 Click **OK**.

Step 6 Repeat Step 3 to 5 to add multiple users.

Converters support the addition of up to 15 general users.

Step 7 To delete a user, move the cursor to the user name you want to delete, then click the delete button "X" appeared at the top-right corner.

Step 8 Confirm the deletion when prompted.

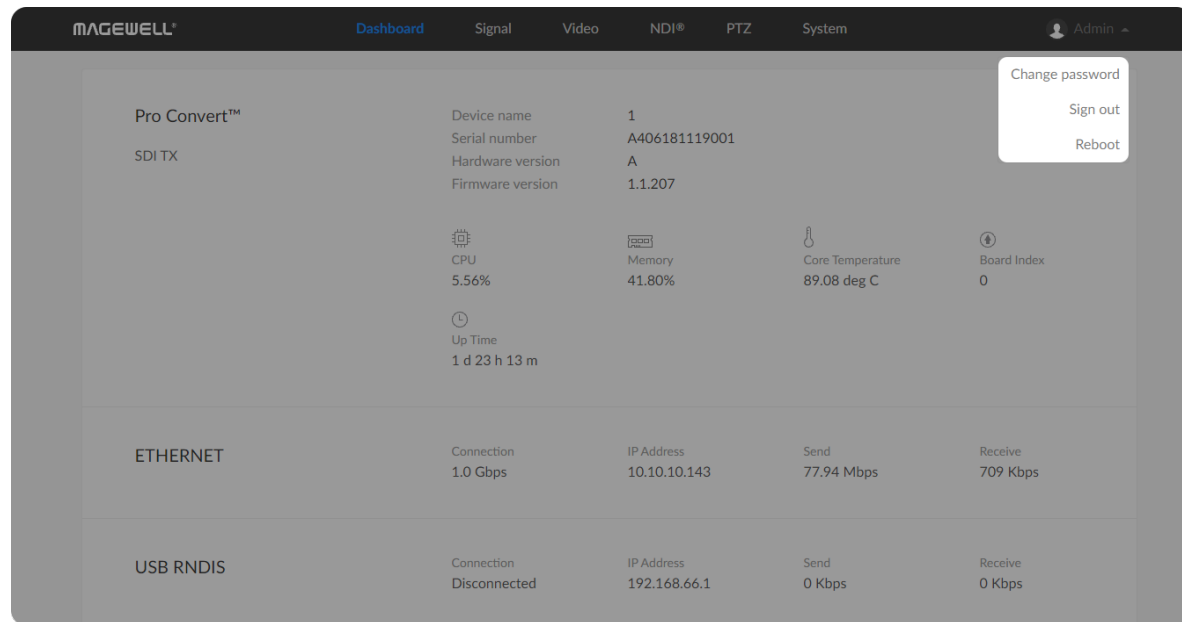

Setting Password

After login, You can either set up a password in the user account drop-list, or in the **System** tab (with administrative rights).

Solution 1: Setting in via the user account drop-list

Step 1 Access the Web UI, and sign in with your username and password.

Step 2 Click the drop-list icon  beside the logged-in username, and click **Change password**.

Step 3 In the prompt window, type in your old password, the new password, and confirm your new password.

The password is a string of 1 to 32 characters, which contains letters A-Z, a-z, numbers 0-9 and special characters `_~!@#$%^&*~+=.`

Step 4 Click **OK**.

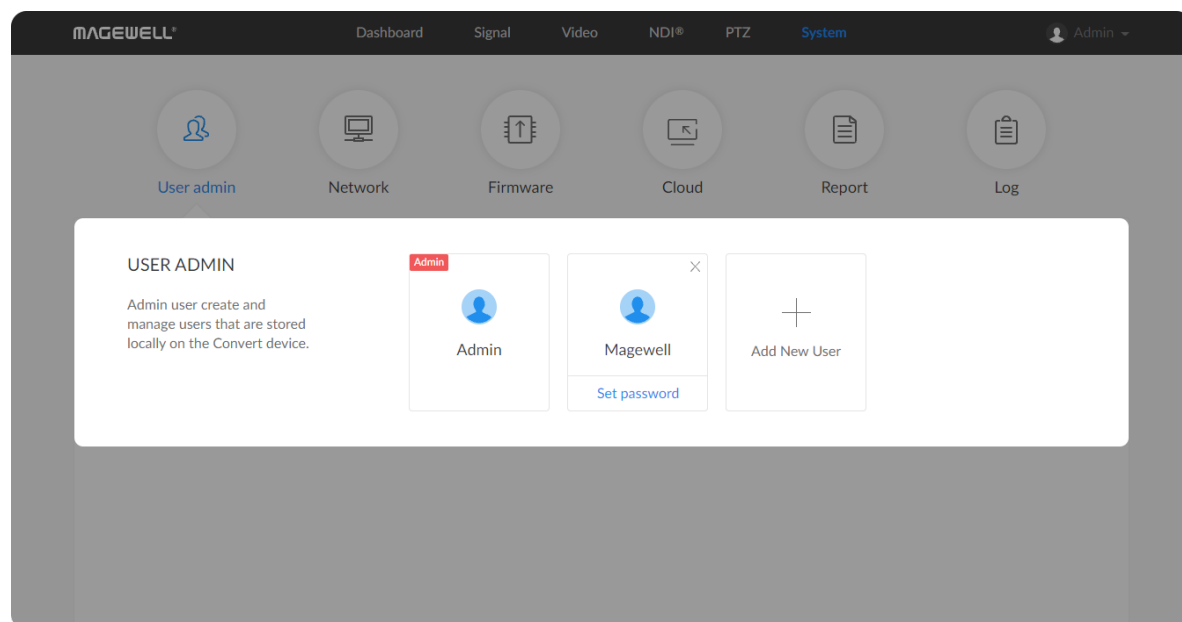

Solution 2: Setting in the System tab

Step 1 Access the Web UI and sign in from the administrator account, then you can change any user's password.

Step 2 Click and enter the **System** tab.

Step 3 Move the cursor to the specific user name, then click **Set password**.

Step 4 In the prompt window, type in and confirm your password.

The password is a string of 1 to 32 characters, which contains letters A-Z, a-z, numbers 0-9 and special characters `_~!@#$%^&*~+=.`

Step 5 Click **OK**.

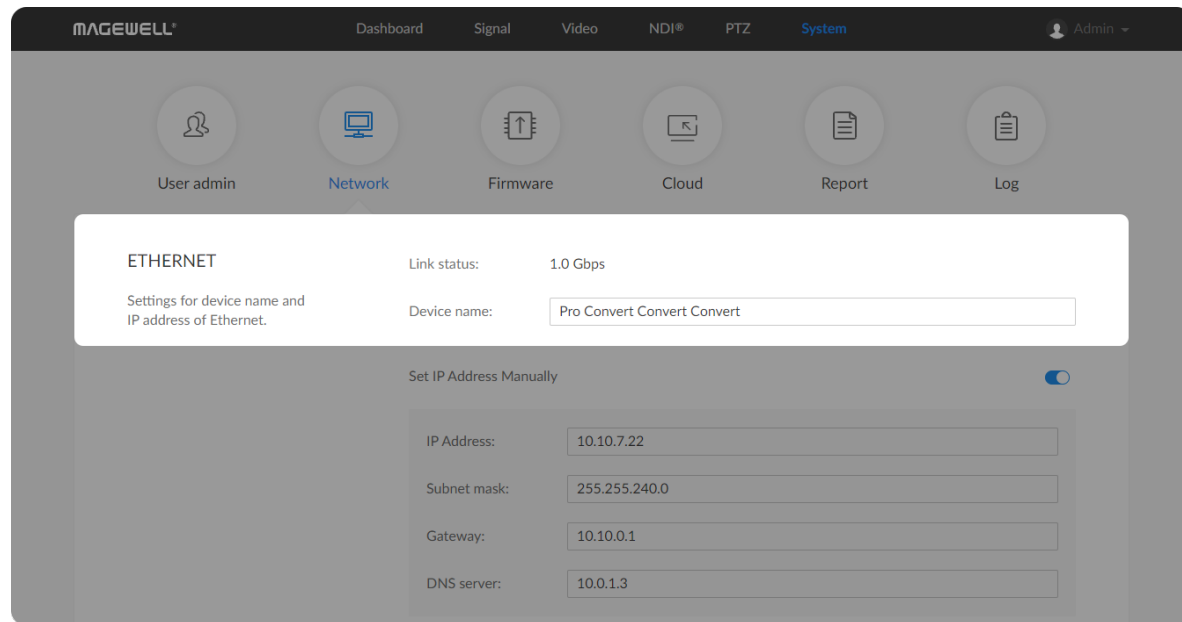

Setting Device Name

To change device name in the **System** tab requires administrative rights. By default, the device name is the same as the product model name.

Step 1 Access the Web UI, and sign in as administrator.

Step 2 Click and enter the **System** tab, then select **Network**.

Step 3 Enter a new **Device name**.

The device name is a string of 1 to 30 non-case sensitive characters, containing letters a to z, A to Z, 0-9, spaces and special characters like _-+.

Step 4 Click **Apply** to save changes, and confirm with **Yes** when prompted.

Network Settings

To change network connections in the **System** tab requires administrative rights. You can change the device name while setting network parameters. By default, the Pro Convert unit automatically detects any connected network. You can set a static IP Address if the device failed to auto-configure using DHCP. If multiple devices are connected using Ethernet over USB, change the RNDIS IP address according to your own arrangement.

Setting Ethernet IP Address

Step 1 Access the Web UI, and sign in as administrator.

Step 2 Click and enter the **System** tab, then select **Network**.

Step 3 Turn on **Set IP Address Manually**, then enter a new **IP address**, **Subnet mask**, **Gateway**, and **DNS server**.

Step 4 Click **Apply** to save changes.

Step 5 When the prompt appears, click **Yes**.

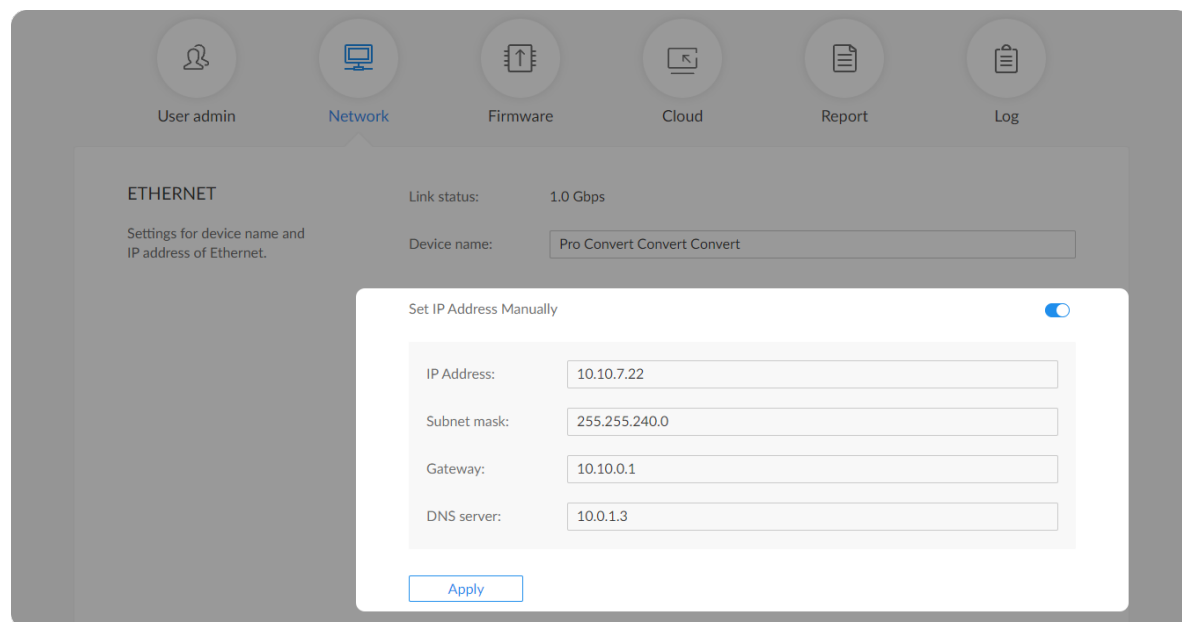

The screenshot displays two network configuration sections. The top section, titled "ETHERNET", shows a link status of "1.0 Gbps" and a device name of "Pro Convert". Under "Set IP Address Manually", the IP address is "192.168.1.60", subnet mask is "255.255.255.0", gateway is "192.168.1.1", and DNS server is "10.0.0.3". An "Apply" button is visible below these fields. The bottom section, titled "USB RNDIS", shows a link status of "High Speed" and an IP address of "192.168.66.1". An "Apply" button is also present below this section.

Step 6 Type the manually assigned IP address in your web browser to access the Web UI, verifying if the network settings work.

Setting Ethernet over USB IP Address

RNDIS (Microsoft's widely used Ethernet over USB protocol)/ECM (Ethernet Control Model) provides a virtual Ethernet link for the converter to connect to a computer operating system.

Note:

- It is not recommended that you modify this IP address unless there is a conflict on your LAN.
- Do not connect more than one converter simultaneously to one system when using Ethernet over USB.

Step 1 Access the Web UI and sign in as administrator.

Step 2 Click and enter the **System** tab, then select **Network**.

Step 3 Enter a new **IP address** for Ethernet over USB.

Step 4 Click **Apply** to save changes, then click **Yes** when prompted.

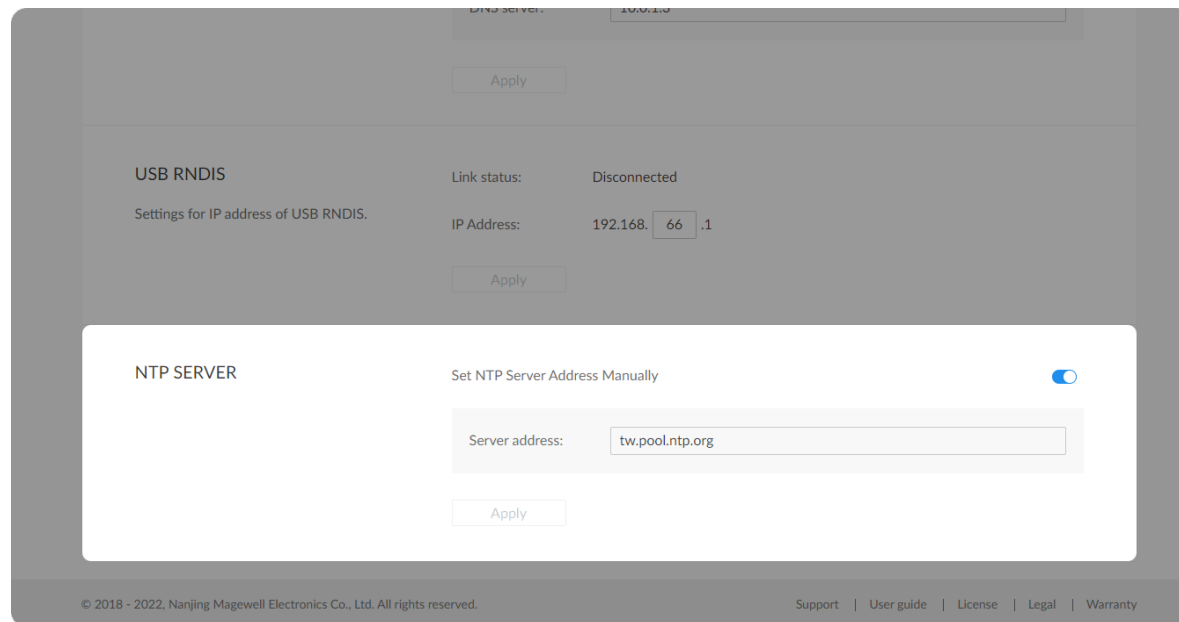

Setting an NTP Server

- Step 1 Access the Web UI and sign in as administrator.
- Step 2 Click and enter the System tab, then select Network.
- Step 3 Turn on the Set NTP Server Address Manually switch, and type the IPv4 address or domain name of an NTP server or pool, such as pool.ntp.org.
- Step 4 Click Apply to save changes.

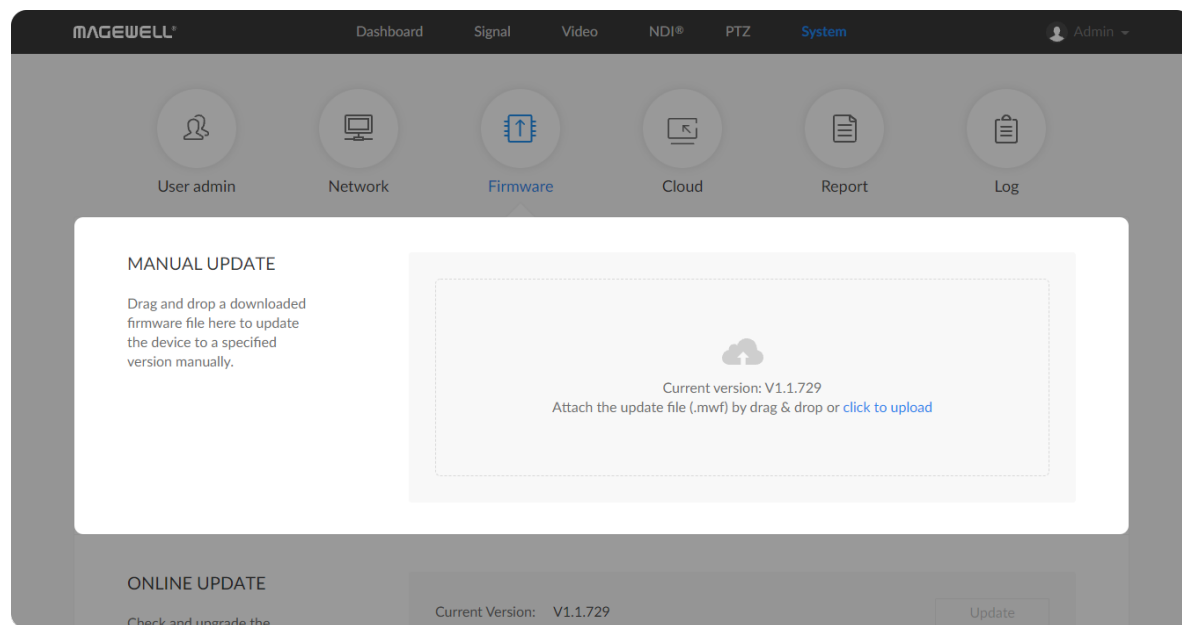

Figure1. Click Manual update

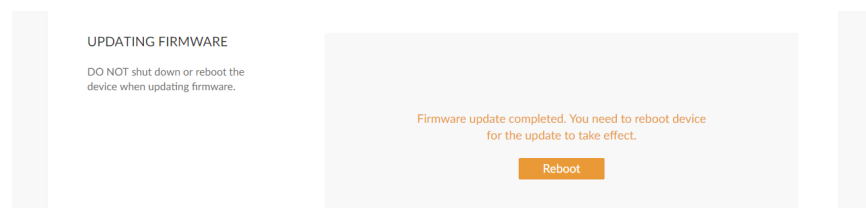

Figure2. Click Reboot

Updating the Firmware

To update the firmware via the **System** tab requires administrative rights.

Note: Currently online update is not supported.

- Step 1** Access the Web UI, and sign in as administrator.
- Step 2** Click and enter the **System** tab, then select **Firmware**.
- Step 3** Click on **click to update** to select the **.mwf** firmware update file from your local storage, or just drag and drop the file from your computer into the upload zone.

You can download the Pro Convert firmware package from the Downloads section of the Magewell website:

www.magewell.com/downloads/pro-convert.

- Step 4** Click **Open** to upload the updates package.
The device will automatically verify the update file.
The unit will upload the file after the file verification is passed.

- Step 5** In the **Manual Update** window, click **Update**.
DO NOT shut down or reboot the device when updating firmware.

- Step 6** Click **Reboot** to complete the update.
The changes take effect after you reboot the device.

- Step 7** Log in to your unit's Web UI and check the current **Firmware version** in the **Dashboard** tab.

The **Firmware version** should have changed to show the number of the new update.

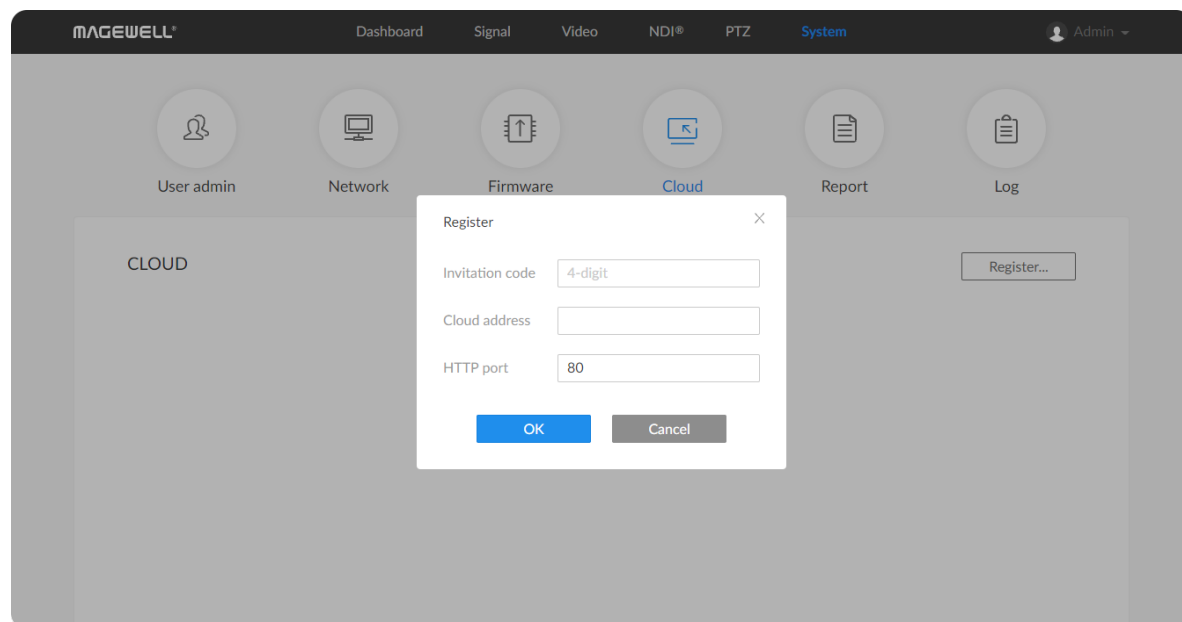

Registering for Magewell Cloud

Pro Convert can be remotely controlled using Magewell Cloud. Detailed Cloud information refers to [official site](#).

- Click **Register...** and input parameters in the prompted window.
 - **Invitation code:** 4-number security code obtained from Magewell Cloud. If none, leave it empty.
 - **Cloud address:** input IP address or domain name of Cloud.
 - **HTTP port:** input HTTP port number, which should be consist with that of Cloud.

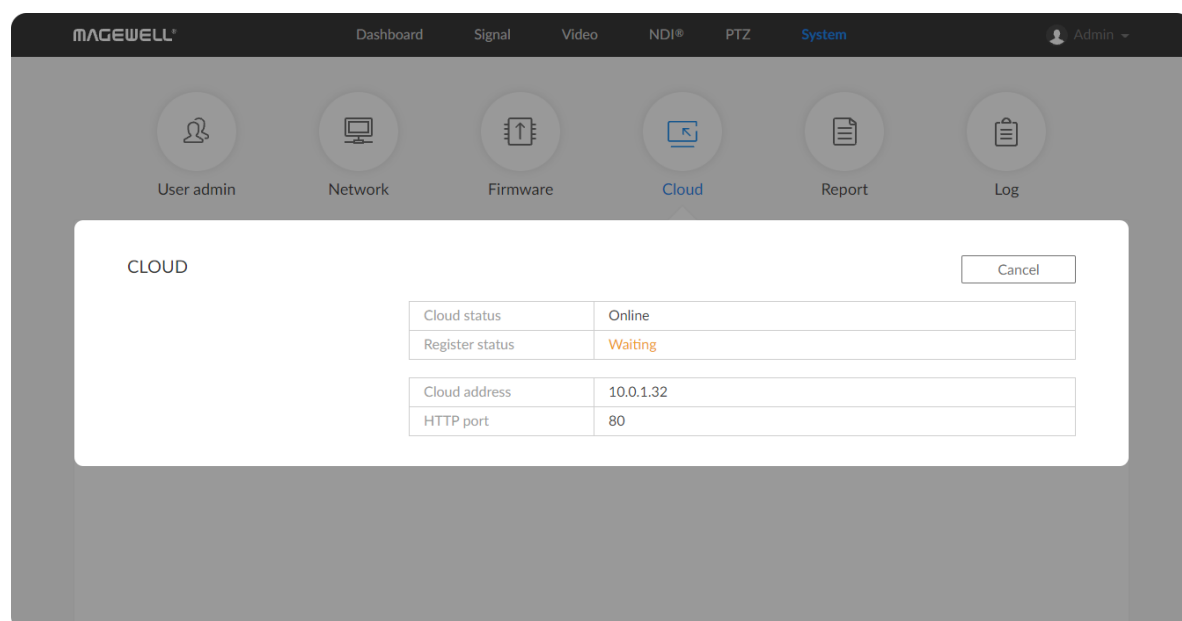

Checking Cloud Status

- **Cloud status: Online or Offline.** Online indicates that the communication between device and Cloud platform goes well. On the other hand, Offline indicates the communication is interrupted.
- **Register status:** shows current status of cloud-join permission, including
 - Incorrect invitation code: you need to change your registration with correct code.
 - Waiting: registration is successfully submitted to Cloud and you can click **Cancel** to withdraw the registration.
 - Approved: registration is approved. This device can be remotely controlled.
 - Rejected: Registration is denied.
 - Deleted: Registration is deleted, you can re-apply for joining the Cloud.
- **Cloud address:** shows IP address or domain name of Cloud.

- **HTTP port:** shows the HTTP port of device used to communicate with Cloud.

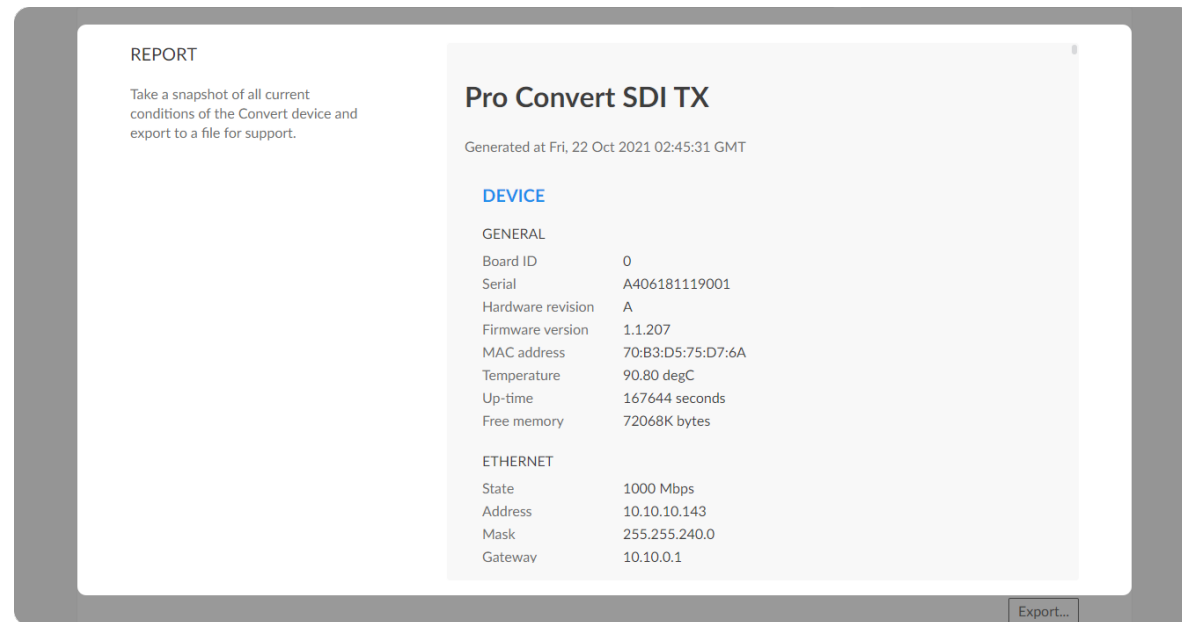

Exporting Reports and Logs

You can export reports and logs from your converter when you want to get help from the Magewell Support team. These files will help our support engineers get a better understanding of your device status and other related equipment like the source device. These operations require administrative rights.

Exporting Reports

- Step 1** Access the Web UI and sign in as administrator.
- Step 2** Click and enter the **System** tab, then select **Report**.
- Step 3** Click **Export...** to generate a .html file.
- Step 4** When the prompt appears, click **Export**.

SYSTEM LOG

Track important events generated by the device and export them as a file for technical support.

Total : 539 events All Information Warning Error

Level	Date & Time	Detail
ⓘ	2021-10-19 15:51:56	User 'Admin' (10.10.11.125) logged in, session: 18905
ⓘ	2021-10-19 15:51:49	User 'Admin' (10.10.11.125) logged out, session 18903
ⓘ	2021-10-19 15:25:33	User 'Admin' (10.10.11.125) logged in, session: 18903
⚠	2021-10-18 19:04:08	User '123' (10.10.3.121) session 10170 timeout
⚠	2021-10-18 18:24:02	User 'Admin' (10.10.11.125) session 10434 timeout
ⓘ	2021-10-18 16:28:14	User 'Admin' (10.10.11.125) logged in, session: 10434
ⓘ	2021-10-18 16:24:38	User '123' (10.10.3.121) logged in, session: 10170
ⓘ	2021-10-18 16:24:35	User 'Admin' (10.10.3.121) logged out, session 8797
ⓘ	2021-10-18 15:50:45	User 'Admin' (10.10.3.121) logged in, session: 8797
⚠	2021-10-18 13:10:15	User 'Admin' (10.10.3.121) session 392 timeout
ⓘ	2021-10-18 10:43:13	User 'Admin' (10.10.3.121) logged in, session: 392
⚠	2021-10-15 19:18:07	User 'Admin' (10.10.5.241) session 99 timeout
⚠	2021-10-15 16:18:21	User 'Admin' (10.10.3.121) session 43 timeout
ⓘ	2021-10-15 15:50:58	User 'Admin' (10.10.5.241) logged in, session: 99
⚠	2021-10-15 15:43:02	User 'Admin' (10.10.11.125) session 32 timeout
ⓘ	2021-10-15 14:54:18	User 'Admin' (10.10.3.121) logged in, session: 43

Clear Export...

Clearing/Exporting All Logs

- Step 1** Access the Web UI and sign in as administrator.
- Step 2** Click and enter the **System** tab, then select **Log**.
- Step 3** (Optional) Filter current logs.

By default, all logs are displayed in the table. Log entries can be categorized as "error", "warning", and "information".

- **Total** shows the total number of filtered events.
- **All:** Check to show all logs.
The device can store up to 1000 local log entries. After 1000 entries have been recorded, the oldest entry will be deleted before a new one can be added.
- **Information:** Check to show information logs - which record user actions or significant system events, e.g. login and signal locked.
- **Warning:** Check to show warning logs - which mean something has not worked as it should. e.g. Ethernet is disconnected or signal is unlocked.
- **Error:** Check to show error logs - which mean some serious error has happened.

- Step 4** (Optional) Click **Export...** to get a .html file of all logs.
When prompted in the window, click **Export**.

- Step 5** (Optional) Click **Clear** to delete all logs.
When prompted in the window, click **Yes**.

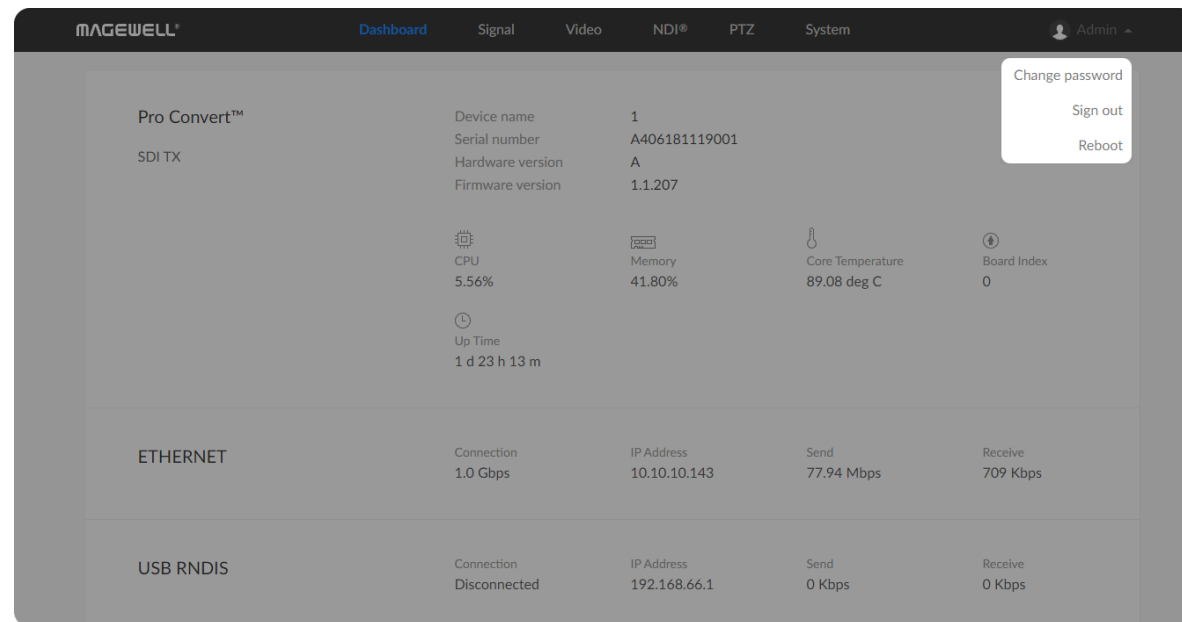

Rebooting/Resetting Pro Convert

Rebooting/resetting your Pro Convert when problems are encountered.

Rebooting Pro Convert

⚠ Rebooting your device will not lose any of your configuration settings.

- Step 1** Access the Web UI and sign in as administrator.
- Step 2** Click the drop-list icon  behind your username at the top-right of the Web UI and select **Reboot**.
- Step 3** When prompted in the window, click **Reboot**.

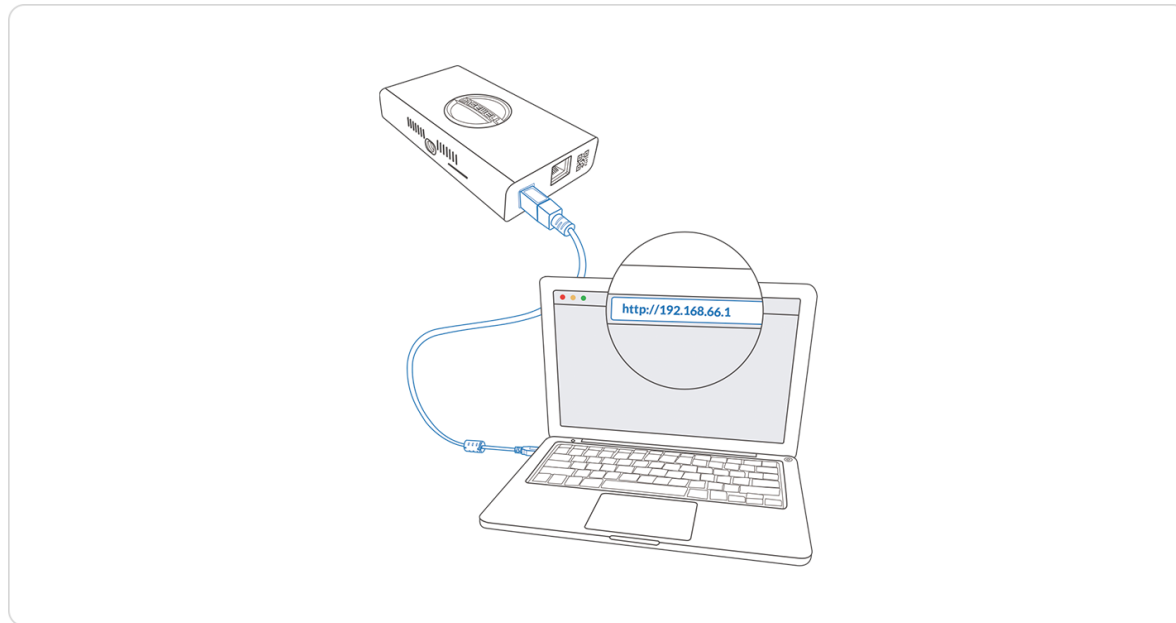

Figure1. Connections

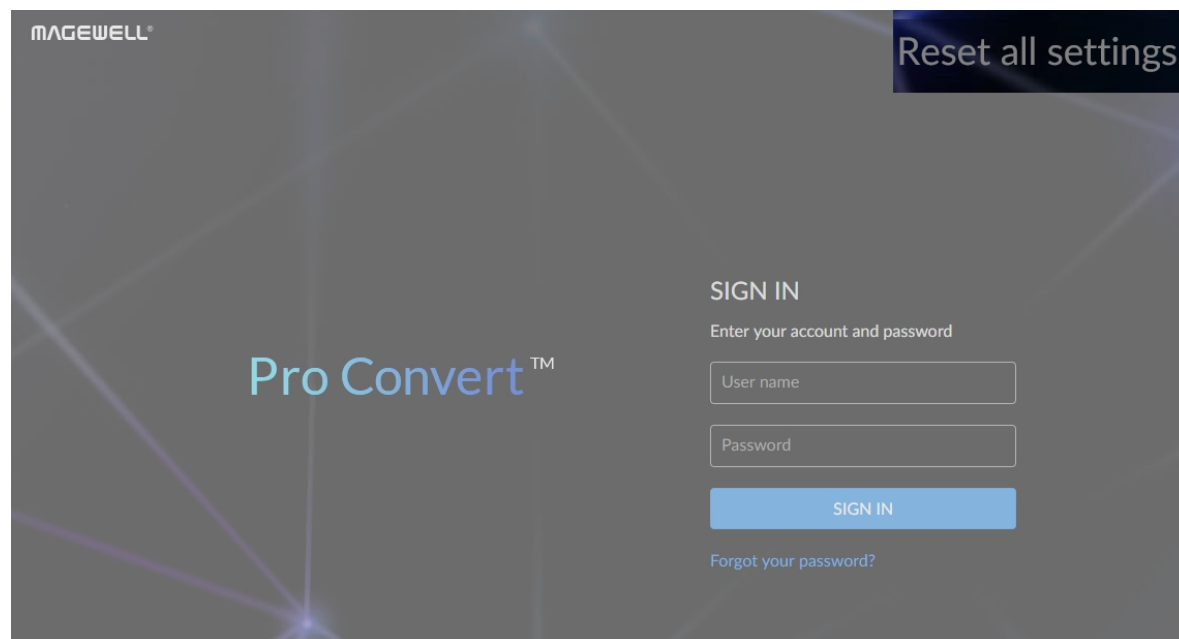

Figure2. Reset all settings

Resetting All Settings

⚠ Warning: Resetting your device will lose all your configuration data.

- Step 1** Connect the device and your computer with the USB cable.
- Step 2** Launch your web browser and type in the Ethernet over USB address to access the Web UI **SIGN IN** page.
- The default address is <http://192.168.66.1>. Please do not change it unless there is a conflict in your network.
- Step 3** Click **Reset all settings** at the top right corner of the **SIGN IN** page.
- The reset process may take a few minutes.

FAQ

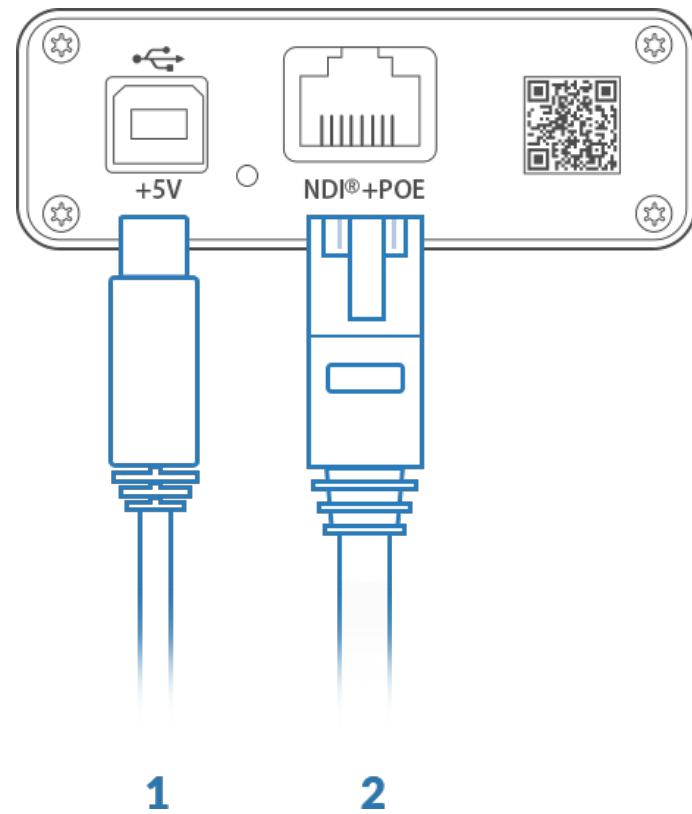

How to supply power to the Pro Convert

There are 2 ways to power your converter as shown in the left figure:

1. Via USB: Plug in the supplied 5V power adapter via the USB cable to supply power.
2. Via PoE: Plug in an Ethernet cable connected to a PoE switch or a PoE adapter for power and Ethernet connection.

Note:

- Pro Convert devices require a 5V DC source with a current rating of no less than 2.1A.
- We recommend that you use only the included Magewell accessories.
- If any included accessory is lost or broken, please contact your Magewell authorized local resellers for help.

Which version of NDI® SDK is compatible with Pro Convert?

NewTek NDI® SDK 4.0 and above are compatible with Pro Convert.

How long it takes for one frame to be input until it is rendered?

After testing, if NDI Monitor, the NewTek official test software is used to preview the NDI stream, the average delay of transmitting 4K@60Hz signal is about 60ms in a Gigabit Ethernet network.

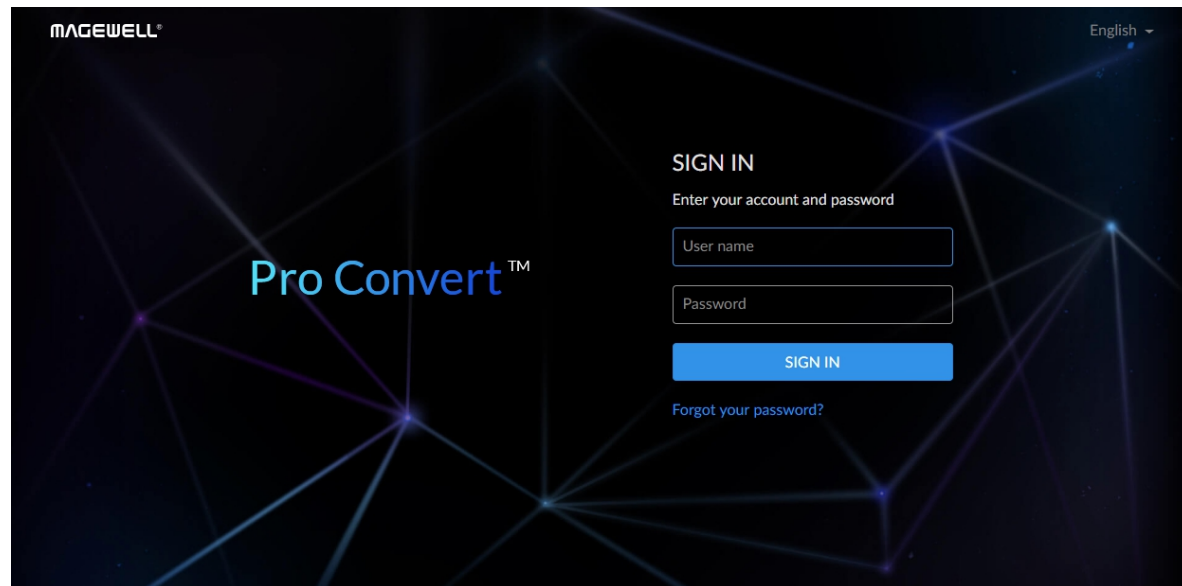

How to configure Pro Convert via Web UI

Pro Convert allows you to set up and control via a web-based user interface as either an administrator or a general user.

You can get access to the Web UI using Windows File Explorer, through your web browser over a USB connection, or with NDI Studio Monitor software. Here takes the Pro Convert HDMI 4K Plus as an example.

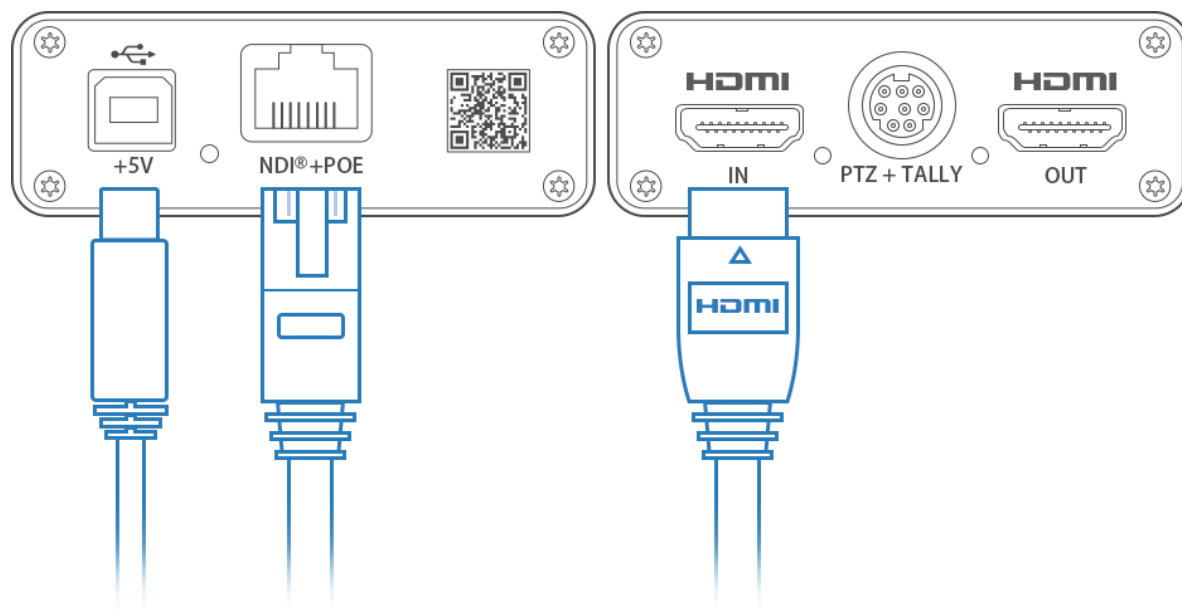

Make sure that at least one of the following web browsers is installed in your system.

- Google Chrome version 49 and above
- Microsoft Internet Explorer 11
- Microsoft Edge
- Mozilla Firefox version 61 and above
- Apple Safari 11.1 and above
- Opera 55.0.2994.44 and above



1. Using Windows File Explorer

This method is available for Windows 7/8/8.1/10 users.

- Step 1** Connect your converter via Ethernet and power it up as shown on the left.
- Step 2** Open a File Explorer window in one of the following ways.
- Click on the Start  button and find File Explorer in the Start menu.
 - Press the Windows logo key  + E.
 - Select the folder icon on the taskbar.

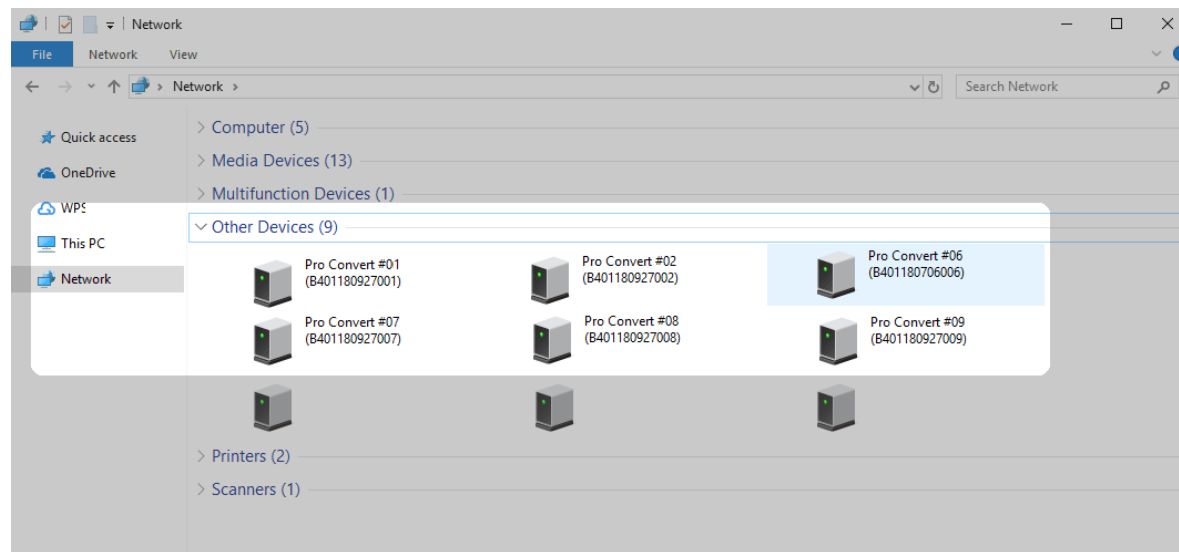

Step 3 Select the **Network** view at the bottom of the list of items on the left side of the File Explorer.

Step 4 Turn on the network discovery function if prompted.

Step 5 Find your Pro Convert device in the **Other Devices** section, where it will be shown as "Pro Convert + #board index + (serial number)".

- The **serial number** (marked on your device) will be in a form like "B401180706006".
- The **board index** (the rotary switch number on your device) is shown like "04" or "#04".

Step 6 Double click the converter icon to open the Web UI of the device in your web browser.

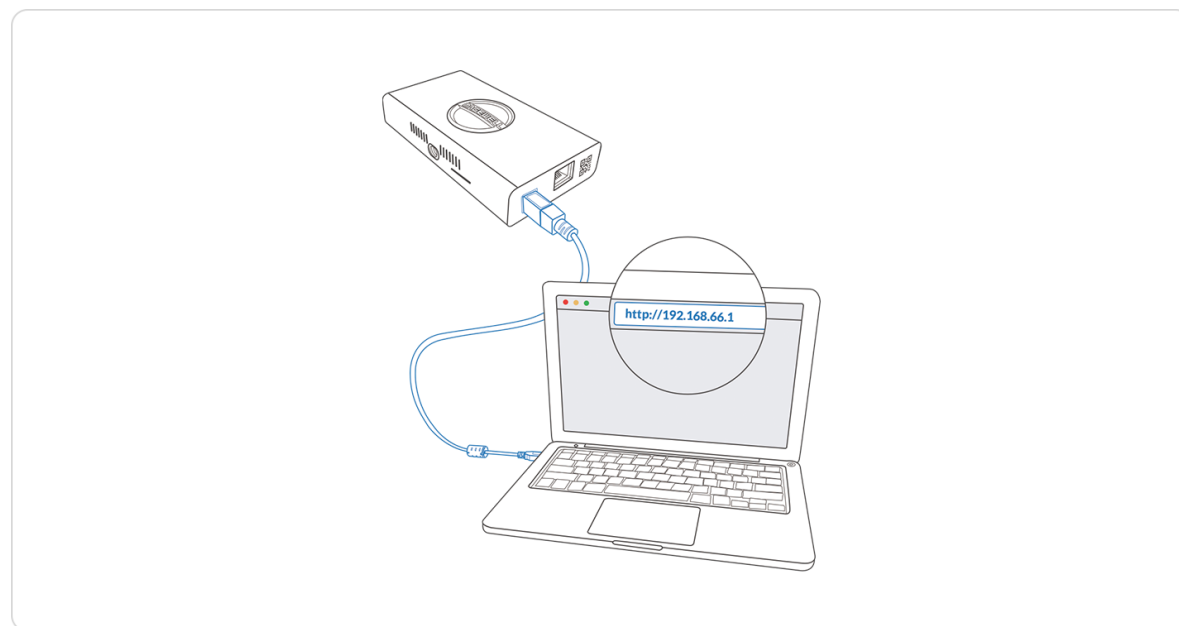

2. Using your web browser over USB

Step 1 Connect the Pro Convert device to your computer using the USB cable.

Step 2 Launch your web browser, and type in USB RNDIS address to access the Web UI. The default address is <http://192.168.66.1>.

Step 3 Enter your account and password in the **SIGN IN** page, and configure the device after you login successfully.

The default admin account (case-sensitive) is Admin, Admin. It is recommended to change the admin password after log-in.

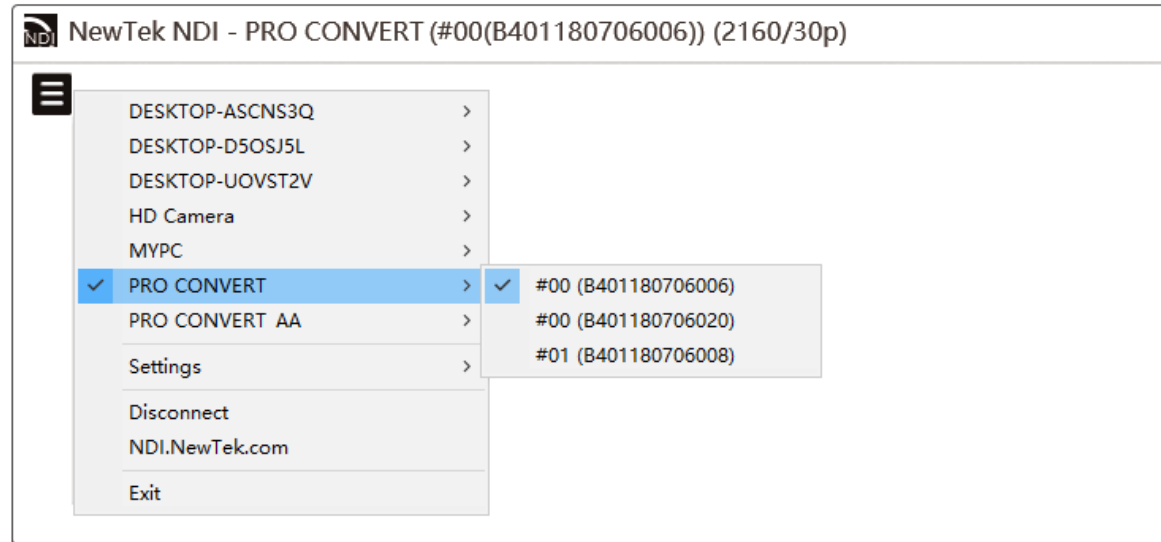

Figure1. Select your NDI channel in NDI Studio Monitor

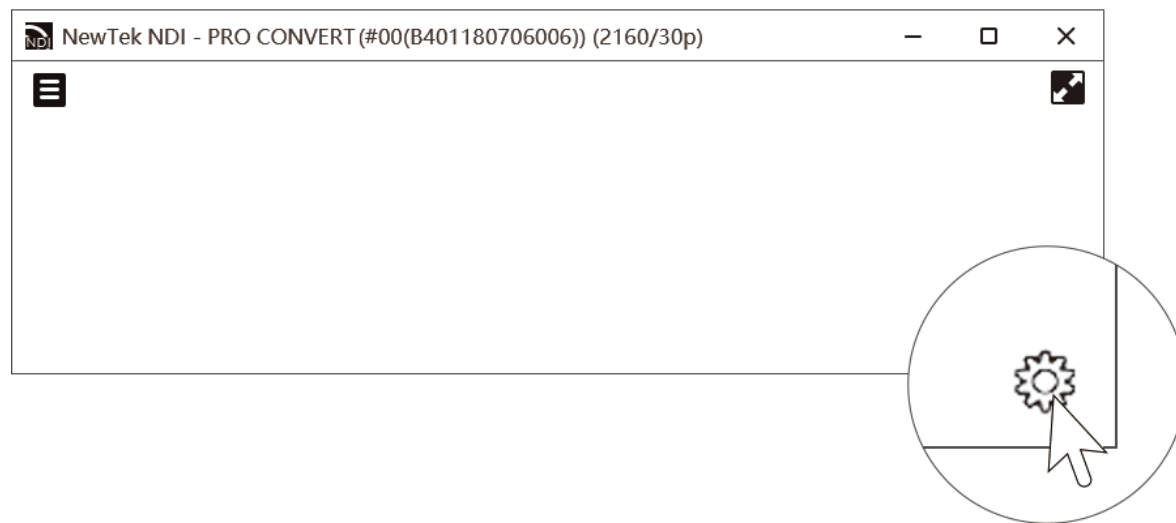



Figure2. Click the gear icon to open the Web UI.

3. Using NDI Studio Monitor

- Step 1** From a computer on the same LAN, download and install **Studio Monitor** from NewTek's official site www.newtek.com/ndi/tools for free.
- Step 2** Run **Studio Monitor** on your system.
- Step 3** Click the Menu icon  at the top left, and select your NDI channel: device name > source name.
- Step 4** Click the gear icon at the bottom right of the Studio Monitor. The web UI of the selected device will open in your web browser.
- Step 5** Enter your account and password in the **SIGN IN** page, and configure the device after you login successfully. The default admin account (case-sensitive) is **Admin, Admin**. It is recommended to change the admin password after log-in.

How to change device name and source name

Pro Convert allows you to set up and control via a web-based user interface as either an administrator or a general user. Changing the device name requires administrator rights, while changing the source name only requires general user rights.

The following describes the operational steps for changing both parameters via the administrator account. A general user account can only change the video source name, but the steps are the same as those for an administrator.

Step 1 Access the Web UI, and sign in as administrator.

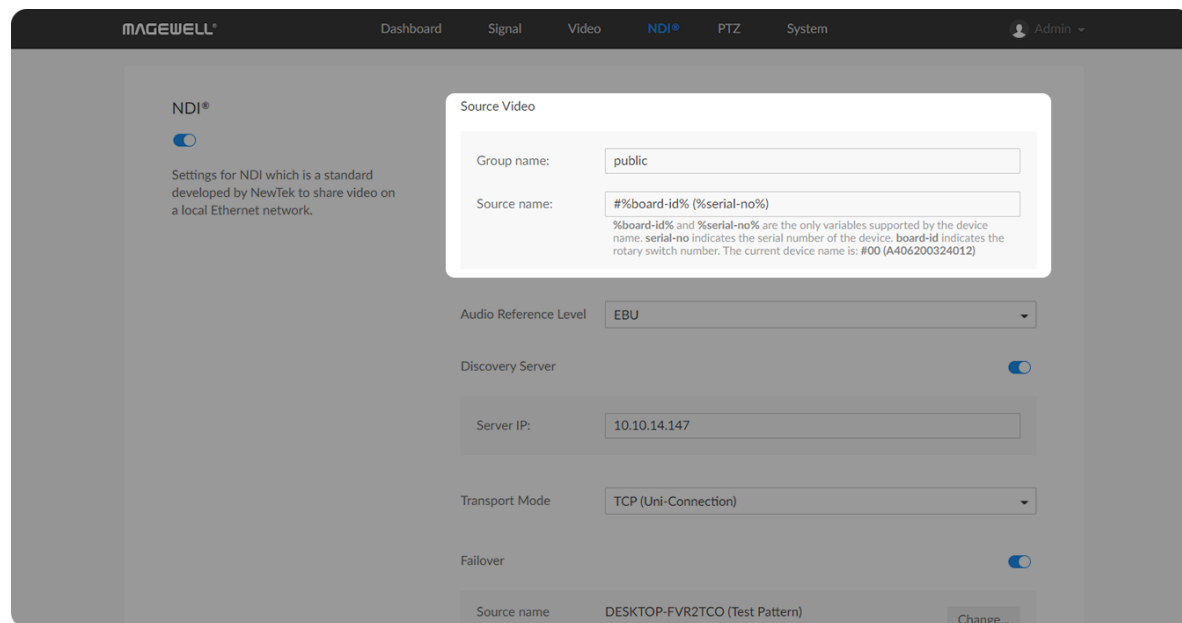

1. Changing source name

Step 2 Click and enter the **NDI®** tab.

Step 3 Change the **Source name**.

The default source name is **#board-id% (%serial-no%)**.

- **board-id** indicates the unit's rotary switch number. You can change the **board-id** by operating rotary switch in your unit.
- **serial-no** indicates the unit's serial number (as shown on the barcode label on its surface).
- **%board-id%** and **%serial-no%** are the only supported variables.
- You can change the source name to a string with maximum of 30 case-sensitive characters, which contains A to Z, a to z, 0 to 9, spaces and special characters like **_-#()**.
- The Source Name will be filled in with the default value **#board-id% (%serial-no%)** automatically after clicking **Apply**, if you leave the parameter empty.

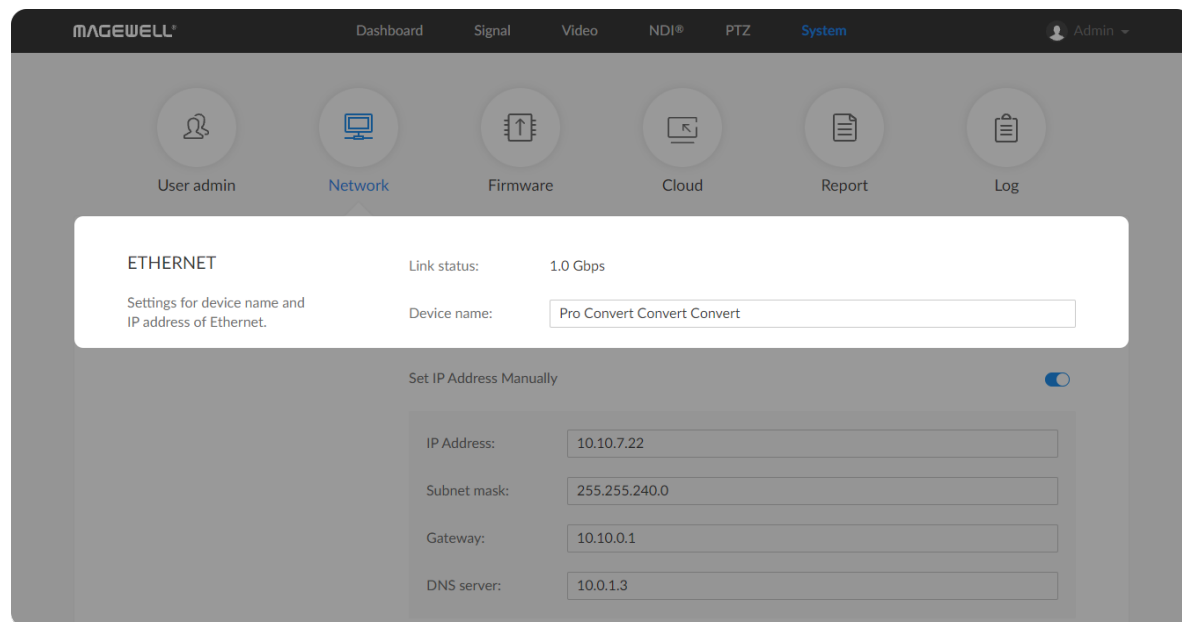

Step 4 Click **Apply** to save your changes.

2. Changing device name

Step 5 Click and enter the **System > Network** tab.

Step 6 Change the **Device name**.

The device name is a string of 1 to 30 non-case sensitive characters, containing letters a to z, A to Z, 0-9, spaces and special characters like _-+.

Step 7 Click **Apply** to save your changes, and then click **Yes** when prompted.

It may take a few minutes for your settings to take effect.

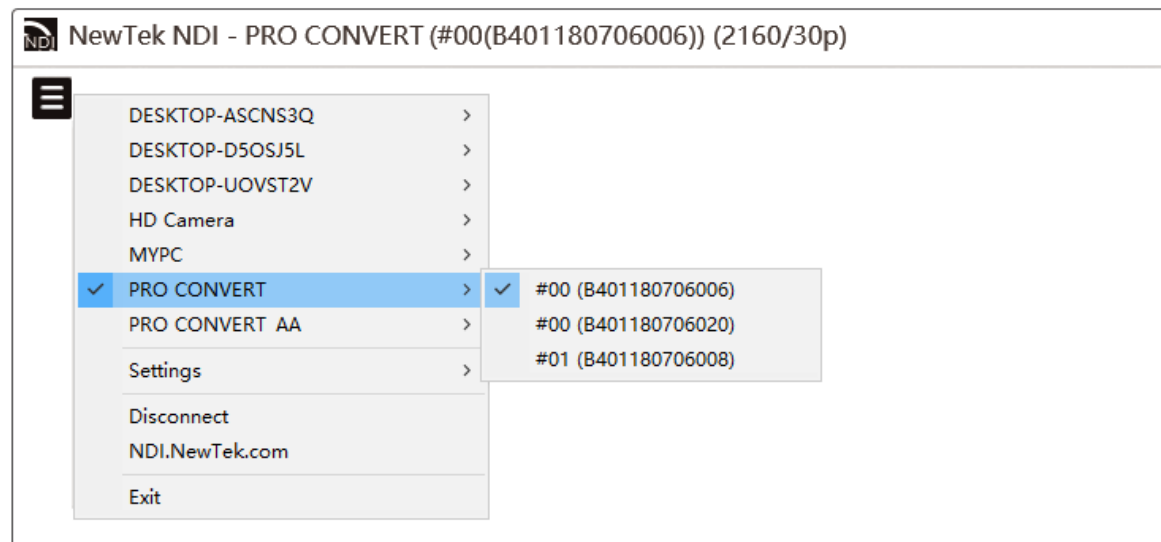

3. Verify your settings

Step 8 Click and enter the **Dashboard** tab in the Web UI to check the **Device name**, and **Name** in the **NDI® > General** section, or verify them by launching NewTek NDI Studio Monitor to check the device name and NDI source name shown there. The values should be the same as your settings.

Download the Studio Monitor software from the NewTek official website www.newtek.com/ndi/tools for free.

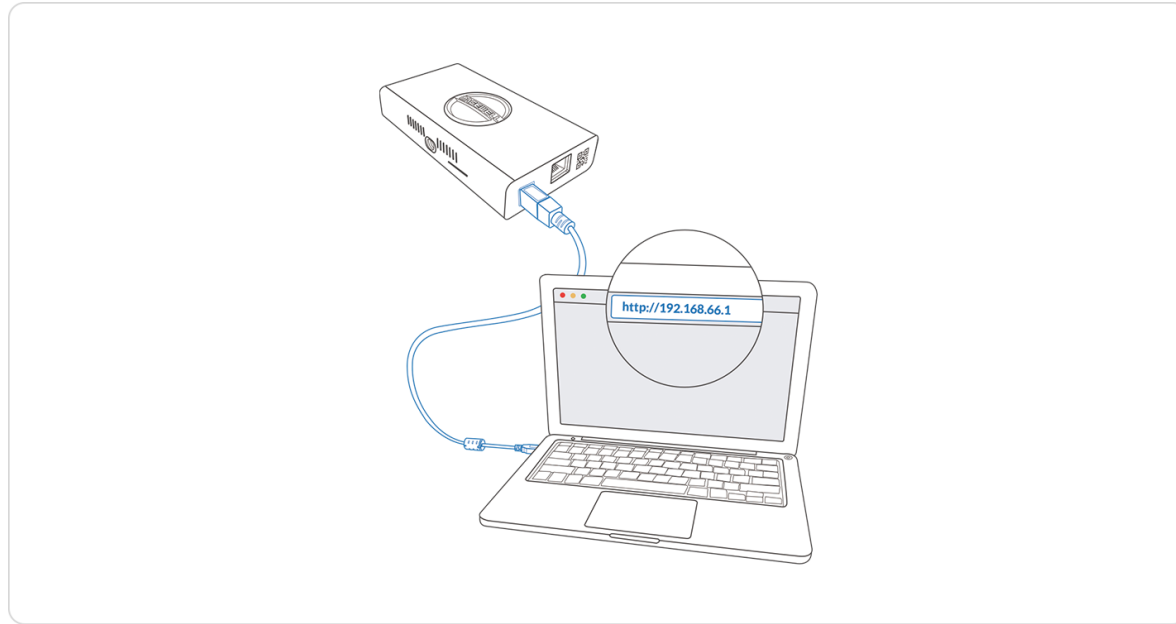

How to reset a Pro Convert device

⚠ Warning: Resetting your device will lose all your configuration data.

Step 1 Connect your converter to your computer.

Step 2 Launch your web browser, and type in the USB RNDIS address to access the Web UI **SIGN IN** page.

The default address is <http://192.168.66.1>. Please do not change it unless there is a conflict on your network.

Step 3 Click **Reset all settings** at the top right corner of the **SIGN IN** page.

The reset process may take a few minutes.

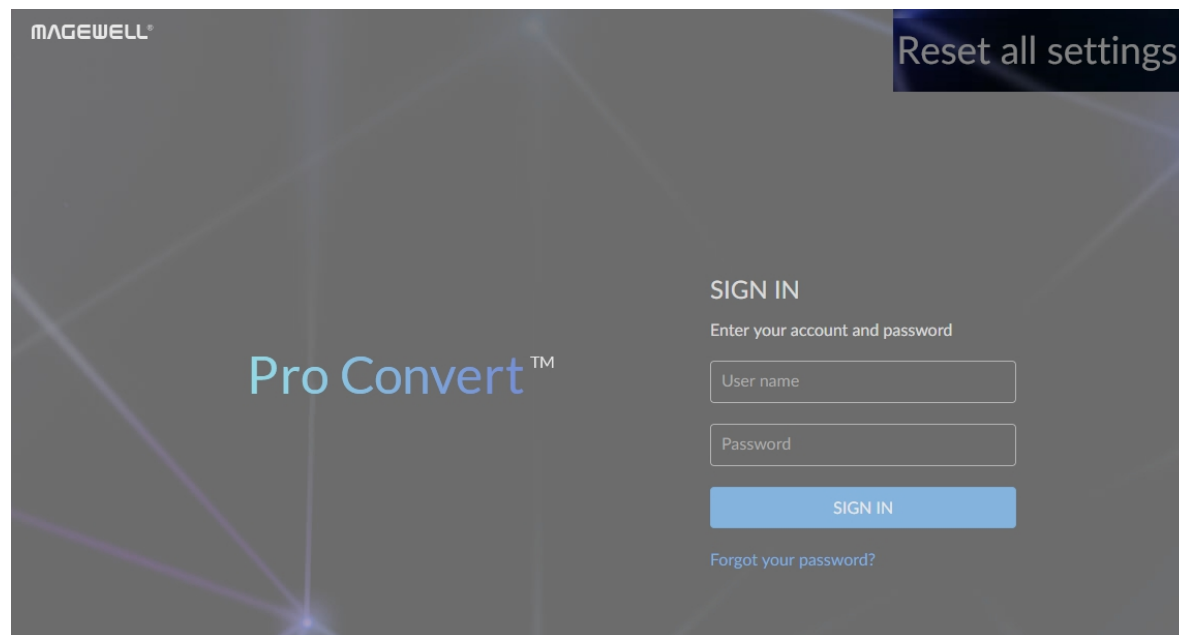

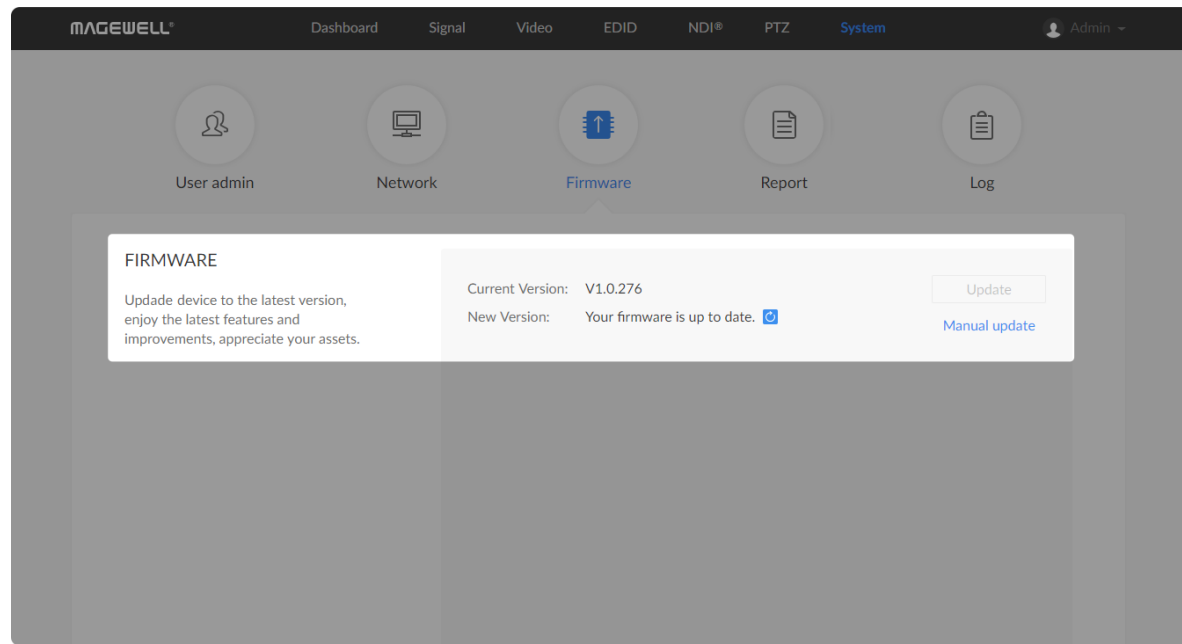

Figure1. Click Manual update

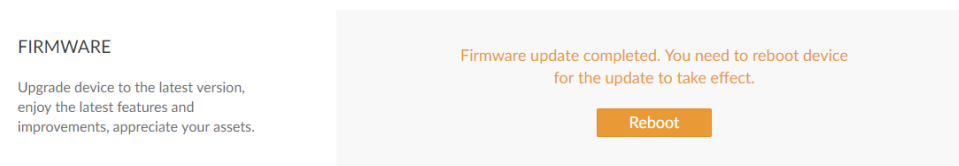

Figure2. Click Reboot

How to manually update the firmware for Pro Convert

You can update firmware via the Web UI with administrative rights.

Step 1 Access the Web UI and sign in as administrator.

Step 2 Click and enter the **System** tab, then select **Firmware**.

Step 3 Click on **Manual update**.

Step 4 Select the **.mwf** firmware update file from your local storage.

You can download the Pro Convert firmware package from the Downloads section of the Magewell website:

www.magewell.com/downloads/pro-convert.

Step 5 Click **Open** to upload the updates package.

The device will automatically verify the update file.

The unit will upload the file after the file verification is passed.

Step 6 In the **Manual Update** window, click **Update**.

⚠ DO NOT shut down or reboot the device during updating procedure.

Step 7 After loading successfully, click **Reboot** to complete the update.

The reboot process may take a few minutes.

Step 8 Login to the Web UI again and check the current **Firmware version** number in the **Dashboard** tab.

The **Firmware version** should now show the number of the new update.

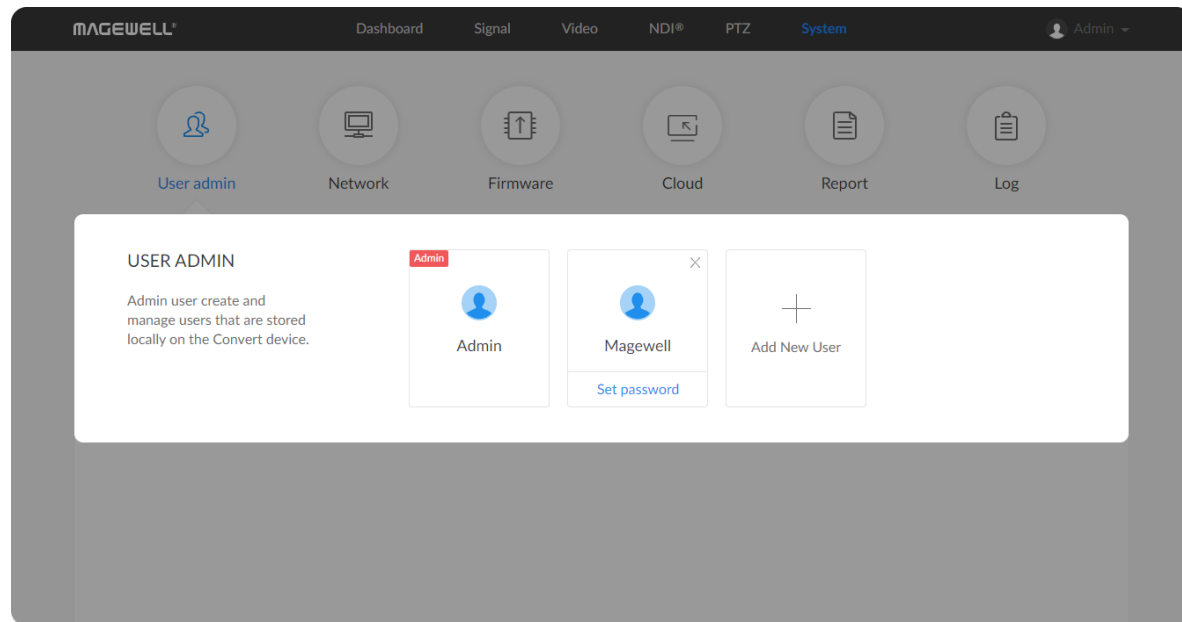

What to do if you forgot the password

If you are a general user, ask your administrator to set a new password for you. If you are the administrator, you need to reset all settings back to default values, then set a new admin password.

1. To reset a general user's password.

- Step 1** Access the Web UI, and sign in as administrator.
- Step 2** Click and enter the **System** tab.
- Step 3** Click the **Set password** link which appears when your mouse hovers over the user name.
- Step 4** Type in new password and confirm the new password as prompted in the window.
The password is a string of 1 to 32 case-sensitive characters, which contains A-Z, a-z, 0-9 and special characters `_~!@#$%^&*~+=`.
- Step 5** Click **OK**.

2. To set a new admin password.

- Step 1** Connect the device to a computer with the USB cable.
- Step 2** Type in the USB RNDIS address to your web browser.
The default IP address of USB RNDIS is <http://192.168.66.1>. Please do not modify it unless there is a conflict on your network.
- Step 3** Click **Reset all settings** at the top-right corner of the **SIGN IN** page.
The reset process may take a few minutes, and all configuration data will be lost – not just the passwords.
- Step 4** Sign in to the Web UI via the default admin account (case-sensitive): Admin, Admin.

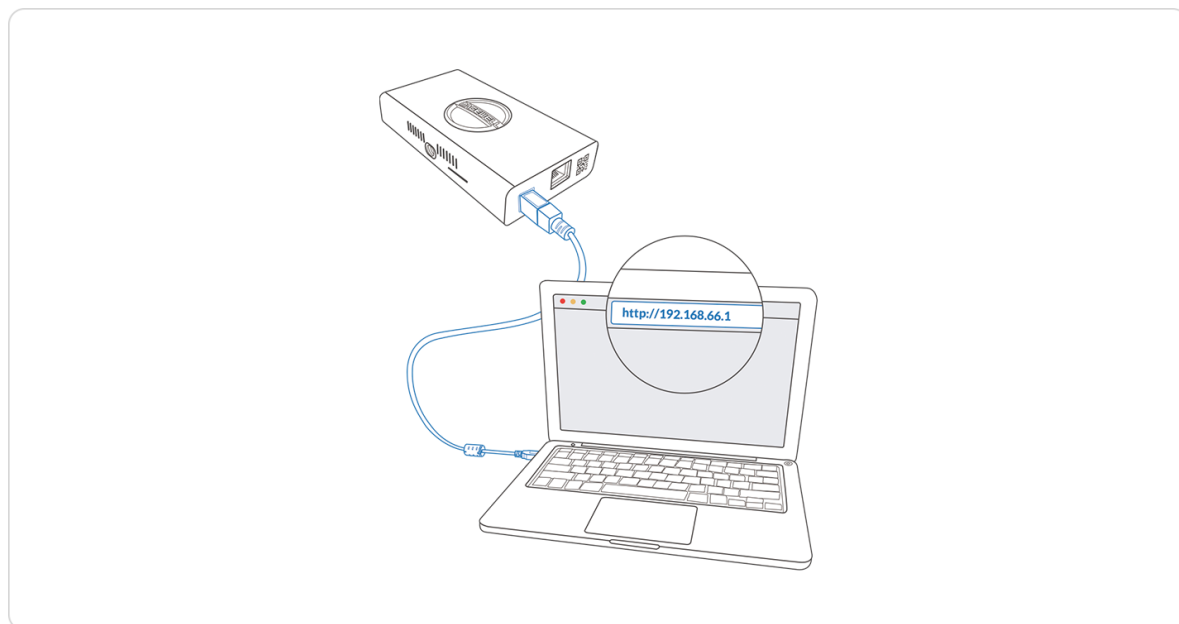

Figure1. Connections

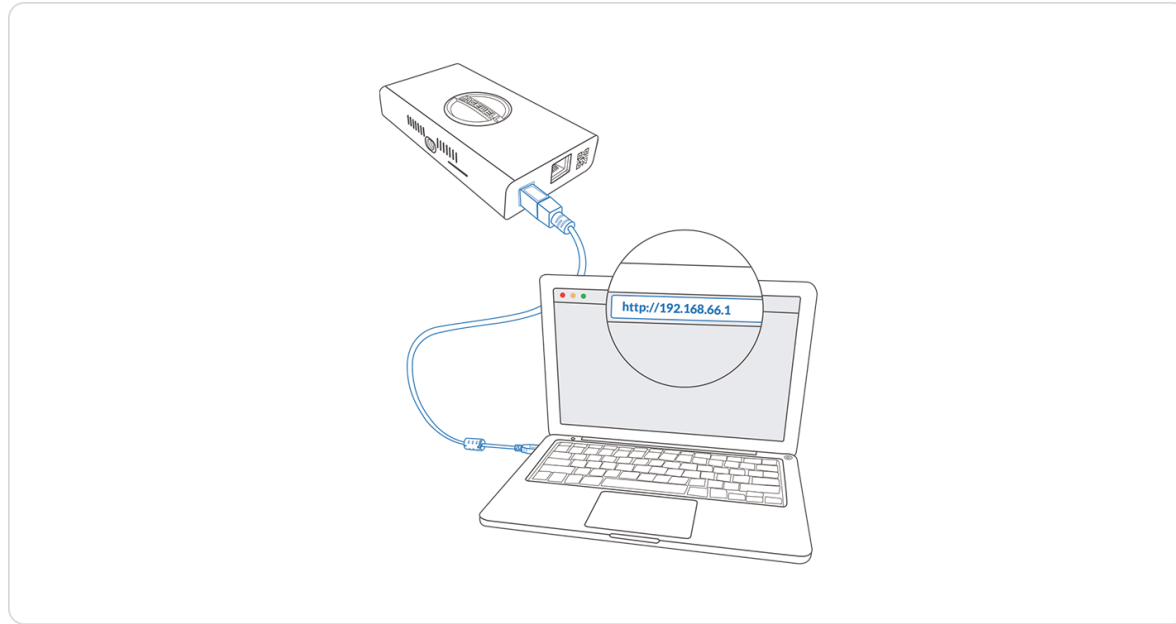

Figure1. Connections

```

Select Command Prompt
C:\Users\win1064>ipconfig

Windows IP Configuration

Ethernet adapter Ethernet:

    Connection-specific DNS Suffix  . : 
    Link-local IPv6 Address . . . . . : fe80::6c54:b184:f07a:eacd%9
    IPv4 Address. . . . . : 192.168.1.124
    Subnet Mask . . . . . : 255.255.255.0
    Default Gateway . . . . . : 192.168.1.1

Ethernet adapter Ethernet 2:

    Connection-specific DNS Suffix  . : 
    Link-local IPv6 Address . . . . . : fe80::146b:1130:8511:736f%17
    IPv4 Address. . . . . : 192.168.55.3
    Subnet Mask . . . . . : 255.255.255.0
    Default Gateway . . . . . : 

Ethernet adapter Ethernet 5:

    Connection-specific DNS Suffix  . : 
    Link-local IPv6 Address . . . . . : fe80::d962:b7ac:a87d:82ed%21
    IPv4 Address. . . . . : 192.168.65.2
    Subnet Mask . . . . . : 255.255.255.0
    Default Gateway . . . . . : 
C:\Users\win1064>

```

Figure2. Windows Command Line Interpreter

How to retrieve your USB RNDIS IP Address

Step 1 Connect the device and your computer with a USB cable as shown in the left Figure1. Connections.

Step 2 Take the following steps according to your operating system.

- For Windows users
 1. Type **cmd** in the search bar to start the command interpreter.
 2. Type in **ipconfig**, and find an IPv4 address of the form 192.168.xxx.2, as shown in [Figure2. Windows Command Line Interpreter](#).
- For Linux users
 1. Launch the **terminal**.
 2. Type in **ifconfig -a**, and find an IPv4 address of the form 192.168.xxx.2, as shown in [Figure3. Linux Terminal](#).
- For Mac users
 1. Click the System Preferences icon in the Dock or choose **Apple menu > System Preferences**.
 2. Choose **Network > Pro Convert**, and check the **IP Address**, as shown in [Figure4. Mac Network](#).

⚠ If 192.168.xxx.2 is taken, the IP address would automatically change to another value within the ranges of 192.168.xxx.2 to 192.168.xxx.254.

Step 3 Type in **192.168.xxx.1** in your web browser to access the Web UI.

```

m@m-System-Product-Name: ~
m@m-System-Product-Name:~$ ifconfig -a
enp0s20u1 Link encap:Ethernet HWaddr 52:a0:c8:a7:36:da
  inet addr:192.168.66.2 Bcast:192.168.66.255 Mask:255.255.255.0
  inet6 addr: fe80::dd8b:5309:1f66:4a2c/64 Scope:Link
  UP BROADCAST RUNNING MULTICAST MTU:1500 Metric:1
  RX packets:32 errors:0 dropped:0 overruns:0 frame:0
  TX packets:33 errors:0 dropped:0 overruns:0 carrier:0
  collisions:0 txqueuelen:1000
  RX bytes:4312 (4.3 KB) TX bytes:6811 (6.8 KB)

enp2s0  Link encap:Ethernet HWaddr 74:d4:35:3d:fd:8c
  inet addr:192.168.1.193 Bcast:192.168.1.255 Mask:255.255.255.0
  inet6 addr: fe80::f27a:b042:8980:a949/64 Scope:Link
  UP BROADCAST RUNNING MULTICAST MTU:1500 Metric:1
  RX packets:63136 errors:0 dropped:0 overruns:0 frame:0
  TX packets:28725 errors:0 dropped:0 overruns:0 carrier:0
  collisions:0 txqueuelen:1000
  RX bytes:76043093 (76.0 MB) TX bytes:2715888 (2.7 MB)

lo      Link encap:Local Loopback
  inet addr:127.0.0.1 Mask:255.0.0.0
  inet6 addr: ::1/128 Scope:Host
  UP LOOPBACK RUNNING MTU:65536 Metric:1
  RX packets:560 errors:0 dropped:0 overruns:0 frame:0

```

Figure3. Linux Terminal

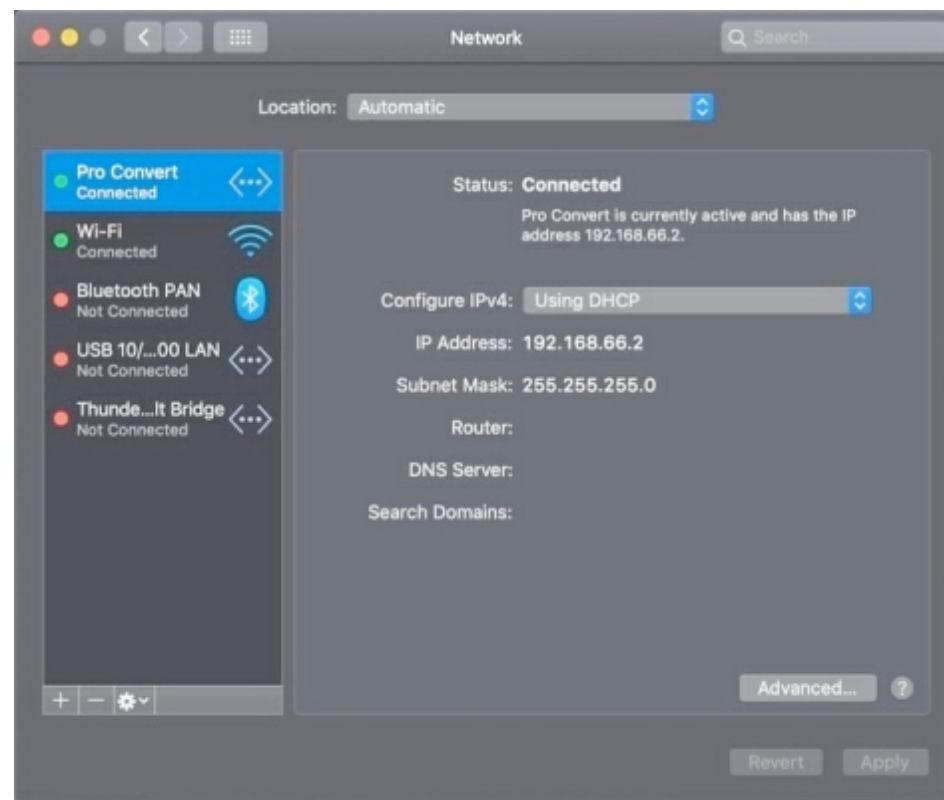

Figure4. Mac Network

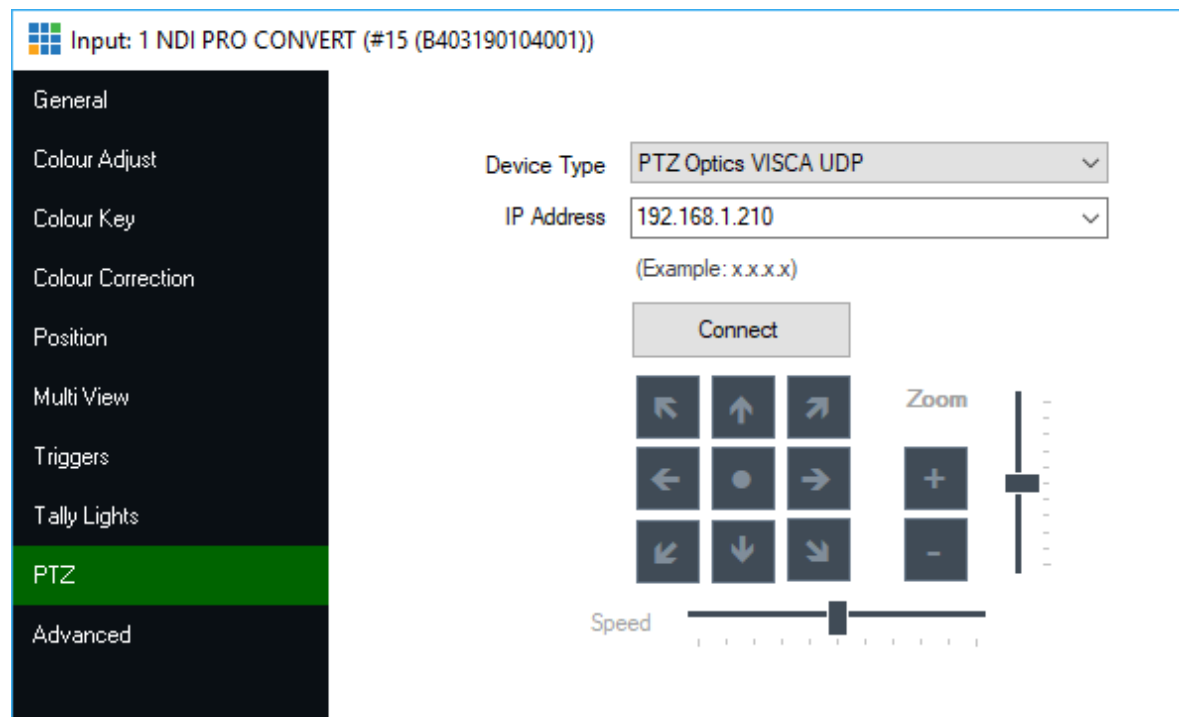

Figure1 vMix PTZ parameters

The encoder and receiver has configured Discovery server, and the Discovery Service deployed in a standalone server, but the receiver cannot get the video stream.

If you are using a standalone Discovery Service server, ensure that the NDI Discovery Service.exe application must have been installed to your standalone server, before the encoder and receiver enabling the Discovery Server.

How to control the PTZ camera via the Visca UDP2rs232 using vMix

Encoders may use the Visca UDP2rs232 protocol for PTZ control protocol since vMix supports PTZ but not NDI PTZ. Set the PTZ parameters of the encoder, PTZ camera and capture software as follows.

1. Connect the encoder to the RS232 IN port of the PTZ camera.
2. Set PTZ control protocol of your encoder to Visca UDP2rs232. The port number of the encoder should be the same as that of the vMix protocol port number.
For vMix, the port number of PTZ Optics VISCA UDP is 1259; the port number of Sony Visca UDP is 52381.
3. Set PTZ camera protocol to Visca.
4. In the vMix, use Visca UDP to control PTZ and fill in with the IP address of the encoder. The vMix configuration is shown as the left figure.

Advanced Visca Parameters ⌵

Focus near limit	<input type="text" value="61440"/>
Focus far Limit	<input type="text" value="4096"/>
Pan left limit	<input type="text" value="-8704"/>
Pan center	<input type="text" value="0"/>
Pan right limit	<input type="text" value="8704"/>
Tilt top limit	<input type="text" value="4608"/>
Tilt center	<input type="text" value="0"/>
Tilt bottom limit	<input type="text" value="-4608"/>
Zoom out limit	<input type="text" value="32512"/>

Advanced settings of PTZ camera

How to change the advanced settings of PTZ camera

Pro Convert device supports advanced control of the PTZ camera. Steps are as follows:

1. Log in to the Pro Convert Web UI.
2. In the **PTZ** tab page, set **Protocol** to **Visca** or **Visca UDP**.
3. Expand **Advanced Visca Parameters** at the bottom of the page.
4. Check the user manual of the camera or contact the manufacturer for detailed control parameters of the camera.
5. Convert the values of camera parameters to decimal numbers and fill them in the corresponding parameter options.
6. Click **Apply** to make the above configurations take effect.

Protocol: Visca UDP

IP Address: 192.168.1.244

Port: 1259

Device ID: 1

Visca UDP message header:

Invert pan direction:

Invert tilt direction:

Advanced Visca Parameters »

Arrange cameras Apply

Set Visca UDP Protocol

How to set the Visca UDP protocol of PTZ camera

Pro Convert device supports control of the network camera via the Visca UDP protocol, without the need to use a PTZ control line to connect the Pro Convert device to the PTZ camera. Steps are as follows:

1. Log in to the Pro Convert Web UI. For details, refer to [How to configure Pro Convert via Web UI](#).
2. In the **PTZ** tab page, set the following parameters:
 - **Protocol:** Visca UDP
 - **IP Address:** The IP address of your camera
 - **Port:** Your camera's Visca protocol network port. Check the user manual of the camera or contact the manufacturer to get it.
 - **Visca UDP message header:** Turn this option on if the communication protocol your camera (e.g. SONY camera) uses the Visca UDP header.
3. Click **Apply** to make the above configurations take effect.

Support

Get the Latest Information

If you have any problems using Magewell products or need more technical information, please visit the following channels.

- Tutorial video: www.magewell.com/tv
- YouTube: [Magewell](#)
- Knowledge base: www.magewell.com/kb/pro-convert
- Official website: www.magewell.com/pro-convert

Technical Support

- Submit your questions in the online Ticket System: tickets.magewell.com
- Contact the Magewell Technical Support Team at support@magewell.net

Warranty

Limited Warranty

Except otherwise set between you and Magewell in advance in a written form, the free limited warranty service starts from the date on your proof of purchase. The proof can be: sales contract, formal sales receipt, invoice or delivery note. The earliest date of these proofs is the starting date of the free limited warranty.

The period of free limited warranty goes as below:

- Pro Convert Family: two (2) years;
- The USB cable and power adapter provided as accessories: one (1) year.

How to get the limited warranty

1. Please contact the Magewell support team by email (support@magewell.net) first, to determine whether your problem can only be solved by returning it to Magewell for repair. Magewell might ask you to take photos of the front and back of the defective products.
2. Magewell will issue an RMA letter to you if it is confirmed that you need to return the faulty product for further examination or repair. Please fill in the RMA with necessary information as required.
If it is regular repair, you will be responsible for the shipping cost, duties and insurance cost (if applicable); if the product is DOA, Magewell will be responsible for the shipping cost.
3. If some components need to be replaced, Magewell will decide to repair, renovate or replace the components by itself. Magewell may use new or repaired component to repair the product. The repaired product can be expected to work normally and the performance to remain the same. Repaired products can work in a good working condition and at least function the same as the original unit. The original replaced component will become the property of Magewell and components which are replaced for the client will become his/her property.
4. If the product is within warranty, Magewell will repair or replace the faulty units at its own discretion. In circumstances where the faulty unit is replaced by another one, Magewell may use new, repaired or renovated units. The faulty unit will then become the property of Magewell while the replacement unit will become the property of the purchaser.
5. If the warranty expires, Magewell will inform the purchaser whether the products can be repaired and the maintenance costs they need to pay. If purchasers

decide to repair, Magewell will repair, renovate, or replace the components after receiving the maintenance costs. If purchasers give up repairing, Magewell will dispose of the faulty unit if the purchaser chooses that option.

6. The repaired or replaced product assumes 1) the remaining term of the Warranty of the replaced unit or faulty unit; 2) ninety (90) days from the date of replacement or repair, whichever provides longer coverage for you. The extended warranty is only valid for repaired/replaced components.
7. The period of service depends on the client's location (country and area) and the product.

To view the complete warranty policy, please visit www.magewell.com/quality-assurance.

Notice

Copyright © 2020 [Nanjing Magewell Electronics Co., Ltd.](#)

All rights reserved. No part of this publication may be reproduced, distributed, or transmitted in any form or by any means, including photocopying, recording, or other electronic or mechanical methods, without the prior written permission of the publisher, except in the case of brief quotations embodied in critical reviews and certain other noncommercial uses permitted by copyright law.

Trademarks

HDMI, the HDMI logo and High-Definition Multimedia interface are trademarks or registered trademarks of HDMI Licensing LLC. Windows, DirectShow and DirectSound are trademarks or registered trademarks of Microsoft Corporation. OS X and macOS are trademarks or registered trademarks of Apple Inc. NDI is trademark or registered trademark of NewTek Inc. Other trademarks and company names mentioned are the properties of their respective owners.

About this Document

- This document is for reference only. Please refer to the actual product for more details.
- The user shall undertake any losses resulting from violation of guidance in the document.
- In case that PDF document cannot be opened, please upgrade the reading tool to the latest version or use other mainstream reading tools.
- This company reserves rights to revise any information in the document anytime; and the revised contents will be added to the new version without prior announcement. Some functions of the products may be slightly different before and after revision.
- The document may include technically inaccurate contents, inconsistencies with product functions and operations, or misprint. Final explanations of the company shall prevail.
- The only warranties for Magewell products and services are set forth in the express warranty statements accompanying such products and services. Nothing herein should be construed as constituting an additional warranty. Magewell shall not be liable for technical or editorial errors or omissions contained herein.

Glossary and Abbreviations

Board Index

Board Index indicates the rotary switch number located in the Pro Convert. It helps users to mark and identify multiple devices

ECM

Ethernet Control Model (ECM) provides a virtual Ethernet link for mac users used on top of USB.

EDID

Extended Display Identification Data (EDID) is a metadata format for display devices to describe their capabilities to a video source.

Failover

Failover is used to provide a high degree of reliability. It switches to a standby NDI source channel upon the failure of the previously active source.

NDI®

NDI (Network Device Interface) is a standard developed by NewTek to transport video, audio & metadata over a local Ethernet network. Visit www.newtek.com/ndi/ for more information.

PoE

Power over Ethernet (PoE) is a networking feature defined by the IEEE 802.3af and 802.3at standards. PoE allows a single cable to provide both data connection and electric power to attached devices.

PTZ Camera

Pan-tilt-zoom (PTZ) cameras are those that are capable of remote control of direction (pan & tilt) and lens zoom.

QoS

Quality of service (QoS) is the description or measurement of the overall performance of a service. To quantitatively measure quality of service, several related aspects of the network service are often considered, such as packet loss, etc.

RNDIS

Remote Network Driver Interface Specification (RNDIS) is a Microsoft proprietary protocol used on top of USB. It provides a virtual Ethernet link to operating systems.

Tally

Tally lights comprise one or more signal-lamps on a professional video camera or monitor, to show when the device is on-air. A preview tally signal is typically green, while a program one is usually shown using the colour red.