

XF605

4K Camcorder

Firmware ver. 1.0.3.1

Safety Instructions

Be sure to read these instructions in order to operate the product safely. Follow these instructions to prevent injury or harm to the operator of the product or others.

WARNING

Denotes the risk of serious injury or death.

2

- Stop using the product in any case of unusual circumstances such as the presence of smoke or a strange smell.
- Do not touch any exposed internal parts.
- Do not get the product wet. Do not insert foreign objects or liquids into the product.
- Do not touch the product connected to a power outlet during lightning storms. This may cause electric shock.
- Do not disassemble or modify the product.
- Do not expose the product to strong shocks or vibration.
- Use only power sources specified in this instruction manual for use with the product.
- Observe the following instructions when using a battery charger or AC adapter.
 - Do not touch the battery charger or AC adapter connected to a power outlet during lightning storms.
 - Do not use the product if the power plug is not fully inserted into the power outlet.
 - Do not unplug the product by pulling the power cord.
 - Do not plug in or unplug the product with wet hands.
 - Do not place heavy objects on the power cord. Do not damage, break or modify the power cord.
 - Do not leave the product connected to a power source for long periods of time.
 - Do not expose the power plug and terminals to dirt or let them come into contact with metallic pins or other metal objects.
 - Do not charge batteries/battery packs at temperatures outside the range of 0 - 40 °C (32 - 104 °F).
- Observe the following instructions when using commercially available batteries or provided battery packs.
 - Do not use leaking batteries/battery packs.
If a battery/battery pack leaks and the material contacts your skin or clothing, flush the exposed area thoroughly with running water. In case of eye contact, flush thoroughly with copious amounts of clean running water and seek immediate medical assistance.
 - Use batteries/battery packs only with their specified product.
 - Do not heat batteries/battery packs or expose them to fire.
 - Do not charge batteries/battery packs using non-authorized battery chargers.
 - Do not expose the terminals to dirt or let them come into contact with metallic pins or other metal objects.
 - Keep batteries out of the reach of children.
 - When disposing of batteries/battery packs, insulate the terminals with tape or other means.
- Do not look through the viewfinder at strong light sources such as the sun on a bright day or lasers and other strong artificial light sources.
- Do not leave the lens exposed without the lens cap attached. The lens may concentrate the light and cause fire.
- Do not wrap the product in cloth or other materials when in use or shortly after use when the product is still warm in temperature.
- Do not allow the product to maintain contact with the same area of skin for extended periods of time during use. This may result in low-temperature contact burns, including skin redness and blistering, even if the product does not feel hot. The use of a tripod or similar equipment is recommended when using the product in hot places and for people with circulation problems or less sensitive skin.
- Keep the product out of the reach of young children. The accessory shoe cover is dangerous if swallowed. If swallowed, seek immediate medical assistance.
- Periodically remove any dust buildup from the power plug and power outlet using a dry cloth.
- Follow any indications to turn off the product in places where its use is forbidden. Not doing so may cause other equipment to malfunction due to the effect of electromagnetic waves and even result in accidents.
- Before installing, be sure the surface is capable of supporting the total weight of the camera and connected devices, and sufficiently reinforce the surface if necessary.

 CAUTIONS

Follow the cautions below. Otherwise physical injury or property damage may result.

- Do not leave the product in places exposed to extremely high or low temperatures. The product may become extremely hot/cold and cause burns or injury when touched.
- Only mount the product on a tripod that is sufficiently sturdy.
- Do not look at the screen for prolonged periods of time. This may induce symptoms similar to motion sickness. In such a case, stop using the product immediately and rest for a while before resuming use.

-India only-

This product is not to be disposed of with your household waste. This product should be handed over to a designated collection point. For more information regarding return and recycling of WEEE products, please visit <https://in.canon/en/consumer/web/e-waste> or write to us at cipl.ewaste@canon.co.in

Also, this product including its components, consumables, parts and spares complies with the “E-Waste (Management) Rules, 2022” and prohibits use of lead, mercury, hexavalent chromium, polybrominated biphenyls or polybrominated diphenyl ethers in concentrations exceeding 0.1 % by weight and 0.01 % by weight for Cadmium, except for the exemptions set in Schedule II of the Rules.

Table of Contents

Safety Instructions 2

1. Introduction 9

About this Manual 9

Conventions Used in this Manual 9

Supplied Accessories 10

Names of Parts 11

Camera 11

2. Preparations 19

Preparing the Power Supply 19

Using a Battery 19

Using a Power Outlet 22

Using the LCD Screen 23

Date, Time and Language Settings 24

Setting the Date and Time 24

Changing the Language 24

Using the Menus 25

Selecting an Option from the Menu 25

Using the Customized Menus (My Menu) 26

Preparing the Camera 28

Attaching the Microphone Holder 28

Attaching the Lens Hood 28

Lens Diffraction Correction 29

Using the Viewfinder 29

Preparing Recording Media 31

Compatible Recording Media 31

Inserting and Removing an SD Card 32

Initializing Cards 32

Setting a Card's Volume Label 33

Switching Between Card Slots 33

Checking the Remaining Recording Time on a Card 33

Recovering Recordings 34

Selecting the Video Recording Method 35

Setting the File Name for Recordings 37

XF-AVC Clips File Names 37

MP4 Clip and Photo Numbering 38

Using the Fan 40

3. Recording 41

Recording Video and Photos 41

Recording 41

Onscreen Displays 43

Reviewing a Recording 49

Adjusting Camera and Recording Settings 50

Performing Basic Settings with Direct Touch Control 50

Direct Setting Mode (FUNC Button) 51

Video Recording Configuration: Video Format, System Frequency, Resolution and Frame Rate 53

Selecting the System Frequency 54

Selecting the Main Recording Format 54

Selecting the Resolution for Primary Clips 54

Selecting the Frame rate for Primary Clips 54

Selecting the Bit Rate for Primary Clips 54

Proxy Clips 55

Chunk Recording Clips for Automatic Transfer 57

Sub Recording Clips 58

Shutter Speed 60

Changing the Shutter Speed Mode 60

Changing the Shutter Speed Value 61

Flicker Reduction 61

ISO Speed/Gain 62

Automatic ISO Speed/Gain 62

Manual ISO Speed/Gain Value 63

ND Filter 64

Aperture 65

Automatic Aperture 65

Momentary Automatic Aperture - Push Auto Iris 65

Manual Aperture: Changing the Aperture Value 66

Iris Limit 66

Exposure Compensation - AE Shift 67

Light Metering Mode 67

White Balance 68

Auto White Balance (AWB) 69

Color Temperature/Preset White Balance 69

Custom White Balance 70

Zoom 71

- Selecting the Zoom Mode 71
- Selecting the Zoom Controls 72
- Using the Zoom Ring 72
- Using the Zoom Rockers 72

Focus 76

- Manual Focus 76
- Push AF/MF 79
- AF-Boosted MF 79
- Continuous AF 80
- Changing the AF Frame Type and Position 81
- Face Detection 81
- Focus Limit and Macro Shooting 83

Image Stabilization 84**Onscreen Markers, Zebra Patterns and False Color 85**

- Displaying Onscreen Markers 85
- Displaying Zebra Patterns 87
- Displaying False Color 87

Setting the Time Code 88

- Selecting the Time Code Mode 88
- Selecting Drop or Non-Drop Frame 89
- Setting the User Bit 90

Synchronizing with an External Device 91

- Connecting an External Device 91
- Time Code Signal Input 91
- Time Code Signal Output 92
- Reference Video Signal Input (Genlock Synchronization) 92
- Reference Video Signal Output 93

Recording Audio 94

- Audio Format for MP4 Clips 95
- Recording Audio Using the Second Card
 - Recording Functions 95
- Connecting an External Microphone or External
 - Audio Input Source to the Camera 96
- Selecting the Audio Input Source for Audio Channels 97
- Adjusting the Audio Recording Level 98
- Advanced Audio Input Settings 100
- Monitoring the Audio with Headphones 101

Colors Bars/Audio Reference Signal 102

- Color Bars 102
- Audio Reference Signal 102

Video Scopes 103

- Displaying a Video Scope 103
- Changing the Waveform Monitor Settings 103
- Changing the Vectorscope Settings 104

Adding Marks to Clips in CAMERA Mode 105

- Adding a Shot Mark while Recording 105
- Adding an Mark or Mark to the Last Clip Recorded 105

Using Metadata 106

- Setting a User Memo Created with Canon XF Utility 106
- Using News Metadata 107
- Entering Slate Information About the Recording 108

Special Recording Modes 109

- Slow & Fast Motion Recording 109
- Pre-recording 111
- Frame Recording Mode 111
- Interval Recording Mode 112
- Continuous Recording 113

Infrared Recording 114**Using the RC-V100 Remote Controller 115****Recording Remotely Using an NU Protocol Compatible Device 116****Web Camera Function 117****4. Customization 119****Assignable Buttons 119**

- Changing the Assigned Function 119

Custom Picture Settings 124

- Selecting Custom Picture Files 124
- Preset Picture Settings 124
- Editing a Custom Picture File's Settings 125
- Look Files 126
- Saving a Custom Picture File 127
- Available Custom Picture Settings 128

Saving and Loading Menu Settings 133

- Saving Menu Settings 133
- Loading Menu Settings 133

5. Playback 135

Playback 135

- Displaying the Index Screen 135
- Playing Back Recordings 137
- Onscreen Displays During Clip Playback 138
- Clip Playback Controls 139
- Adjusting the Volume 140

File Operations 141

- File Menu Operations 141
- Displaying Clip Information 142
- Adding Marks or Marks 143
- Deleting Marks or Marks 143
- Adding/Deleting Shot Marks 143
- Deleting All the Shot Marks from a Clip 144
- Deleting Recordings 144
- Deleting the User Memo and GPS Information from a Clip 144

6. External Connections 145

Video Output Configuration 145

- HDMI OUT Terminal Video Output Configuration (Recording) 145
- Video Output Configuration (Playback) 147

Connecting to an External Monitor or External Recorder 150

- Using the SDI OUT Terminal 150
- Using the HDMI OUT Terminal 151
- Superimposing Onscreen Displays on Video Outputs 151
- Changing the Opacity Level of Onscreen Displays 152
- Selecting the Output Range 152

Applying a LUT/the View Assistance Function to the LCD Screen 154

- Applying a LUT 156
- Adjusting the Color Quality for HLG Output 156
- User LUTs 156
- Adjusting the Gain Difference When Converting HDR to SDR 158

Audio Output Channels 159

Working with Files on a Computer 160

- Saving Files 160
- Saving MP4 Clips 160
- Saving WAV Files 161
- Automatically Transferring Recording Data to an FTP Server 161

7. Network Functions 163

Network functions and connection types 163

- Using a Wi-Fi Network 164
- Using a Wired (Ethernet) Network 165

Configuring Connection Settings 166

- Activating a Network Connection 166
- Adding a New Connection Setting Using the Wizard 167
- Function Settings 167
- Other Connection Methods 171
- Other Network Settings 174
- 802.1X Authentication 175
- Checking and Changing Connection Settings (SET) 175
- Checking and Changing Communication Settings (NW)/Function Settings (MODE) 176

Checking the Network's Status 180

FTP File Transfer 181

- Transferring a Single Clip 181
- Transferring All Clips 181

IP Streaming 182

Browser Remote: Controlling the Camera from a Network Device 184

- Starting Browser Remote 184
- Using Browser Remote 186

Recording Remotely Using an XC Protocol Compatible Controller/Application 191

- Recording remotely using the RC-IP100/RC-IP1000 Remote Camera Controller 191
- Recording remotely using the Remote Camera Control Application 191
- Recording remotely using Multi-Camera Control 192

Transferring Recordings to a Smartphone 194

8. Additional Information 195

Menu Options 195

Displaying the Status Screens 208

Troubleshooting 218

- List of Messages 224

Handling Precautions 230

Maintenance/Others 232

Optional Accessories 233

Specifications 235

Reference Tables 240

Approximate Recording Time on a Card 240

Charging Times 240

Appendix: Camera Dimensions 241**Index 243**

About this Manual

Thank you for purchasing the Canon XF605. Please read this manual carefully before you use the camera and retain it for future reference. Should the camera fail to operate correctly, refer to *Troubleshooting* (📖 218).

Before Using the Camera

- Before making important recordings for the first time, make test recordings using the video configuration(s) you plan to use to check that the camera operates correctly. Should it fail to operate correctly, refer to *Troubleshooting* (📖 218).
- **Copyright notice:** Unauthorized recording of copyrighted materials may infringe on the rights of copyright owners and be contrary to copyright laws.
- **Notes on privacy and publicity rights regarding the use of video:** When using the camera, exercise proper caution in order to protect privacy and avoid any violation of publicity rights.
- **About the LCD screen and viewfinder:** The screen is produced using extremely high-precision manufacturing techniques, with more than 99.99% of the pixels operating to specification. Very rarely, pixels may misfire or light up permanently. This has no effect on the recorded image and does not constitute a malfunction.
- **About the access indicator:** Observe the following precautions while an access indicator (📖 32) is illuminated or flashing in red. Failing to do so may result in permanent data loss.
 - Do not turn off the camera and do not remove the battery or other power source.
 - Do not open the card compartment cover.

Conventions Used in this Manual

- **!** IMPORTANT: Precautions related to the camera's operation.
- **i** NOTES: Additional topics that complement the basic operating procedures.
- **📖**: Reference page number.
- The following terms are used in this manual.
 - "Screen" refers to the LCD monitor's screen and the viewfinder screen.
 - "Battery" refers to a supplied or optional battery pack.
 - "AC adapter" refers to the CA-CP200 L Compact Power Adapter.
 - "SD card" refers to an SD, SDHC or SDXC memory card.
 - "Card" alone, not specified: refers to SD cards.
 - "CAMERA mode": operating mode for making recordings (shooting mode).
 - "MEDIA mode": operating mode for playing back and managing recordings (playback mode).
 - "Access indicator": when not specified, refers collectively to the SD CARD access indicators.
 - "Multi-Camera Control" refers to Canon Multi-Camera Control.
 - Unless indicated otherwise, shooting functions are utilized in CAMERA mode.
- Photographs in the manual are simulated pictures taken with a still camera.
- Some screenshots have been altered to make them easier to read. Furthermore, screenshots used are from a product in development and may differ slightly from the actual screens due to product enhancement.

Supplied Accessories

The following accessories are supplied with the camera. For accessories sold separately, please refer to *Optional Accessories* (📖 233). Unless indicated otherwise, accessories mentioned in this manual are the ones supplied with the camera.



CA-CP200 L Compact Power Adapter

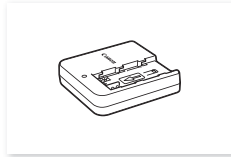

CG-A20 Battery Charger



BP-A30 Battery Pack
(incl. terminal cover)

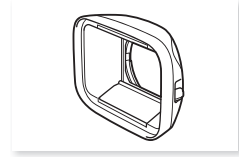

Lens Hood with Lens Barrier



Microphone Holder
(incl. M4 fixation bolts, x2)



Multi-Function Shoe Cover



Viewfinder Cap



Lens Cap



Eye Cup

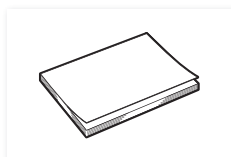

Quick Guide

! IMPORTANT

- Do not use the supplied compact power adapter and power cord with other devices as this may cause a malfunction.

Names of Parts

Camera

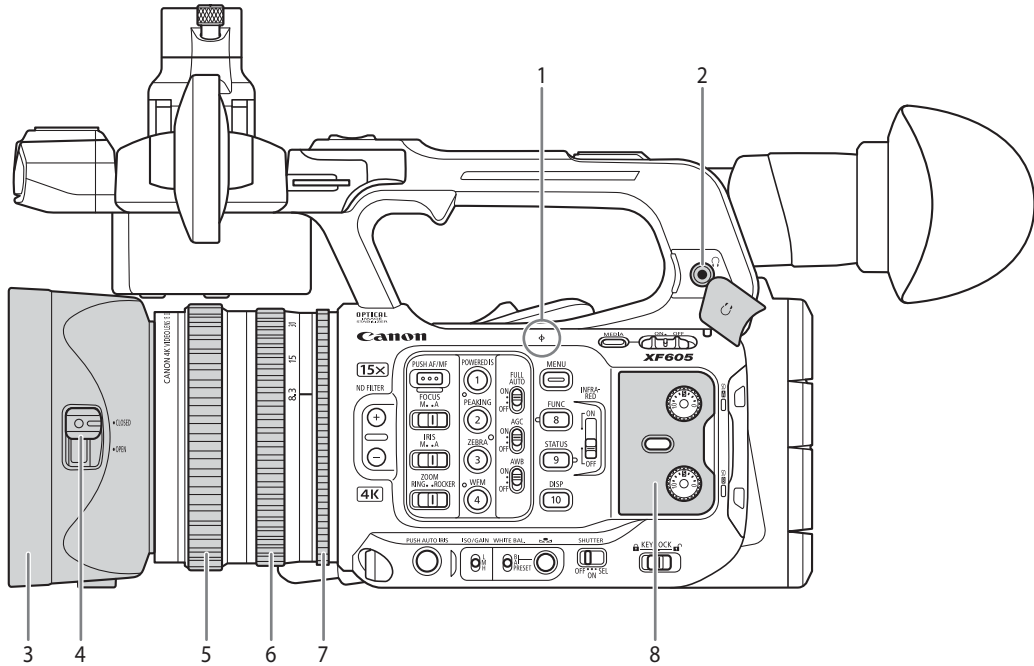

- | | | | |
|---|----------------------------------|---|---|
| 1 | φ Focal plane mark | 5 | Focus ring (76) |
| 2 | (headphone) terminal (101, 140) | 6 | Zoom ring (72) |
| 3 | Lens hood (28) | 7 | Iris ring (66) |
| 4 | Lens barrier switch (41) | 8 | Protective cover for audio controls (94) |

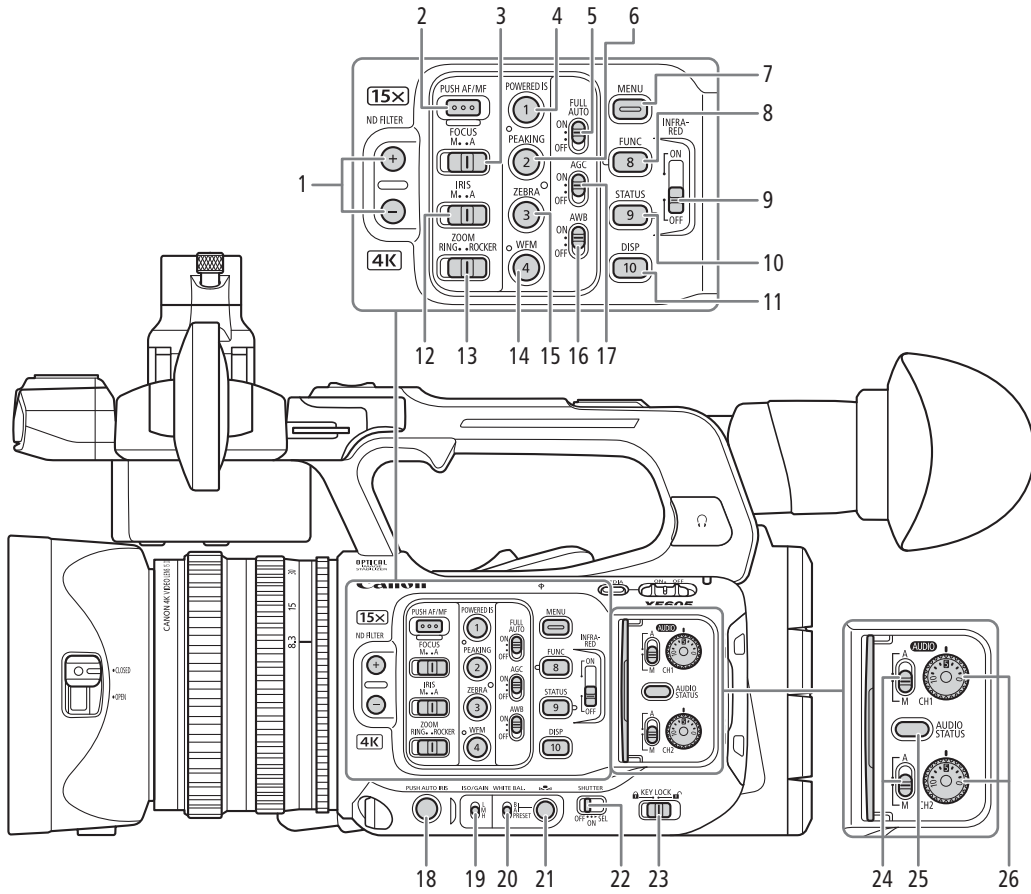

- | | |
|--|--|
| <ul style="list-style-type: none"> 1 ND FILTER +/- buttons (64) 2 PUSH AF/MF (momentary autofocus) button (79) 3 FOCUS (focus mode) switch (76) 4 POWERED IS button (84)/
Assignable button Camera 1 (119) 5 FULL AUTO switch (42) 6 PEAKING button (78)/
Assignable button Camera 2 (119) 7 MENU button (25) 8 FUNC (main functions) button (51)/
Assignable button Camera 8 (119) 9 INFRARED switch (114) 10 STATUS (display status screen) button (208)/
Assignable button Camera 9 (119) 11 DISP (display) button (43, 138)/
Assignable button Camera 10 (119) 12 IRIS (aperture mode) switch (65) 13 ZOOM (zoom control selection) switch (72) | <ul style="list-style-type: none"> 14 WFM (waveform monitor) button (103)/
Assignable button Camera 4 (119) 15 ZEBRA button (87)/
Assignable button Camera 3 (119) 16 AWB (auto white balance) switch (69) 17 AGC (automatic gain control) switch (62) 18 PUSH AUTO IRIS (momentary automatic aperture) button (65) 19 ISO/GAIN switch (63) 20 WHITE BAL. (white balance) switch (69) 21 (white balance adjustment) button (68, 70) 22 SHUTTER (shutter speed mode) switch (60) 23 KEY LOCK (camera's key lock function) switch (15) 24 AUDIO (audio level) switches for CH1 (top) and CH2 (bottom) (98) 25 AUDIO STATUS (display the [] Audio Setup] status screens) button (212) 26 AUDIO (audio level) dials for CH1 (top) and CH2 (bottom) (98) |
|--|--|

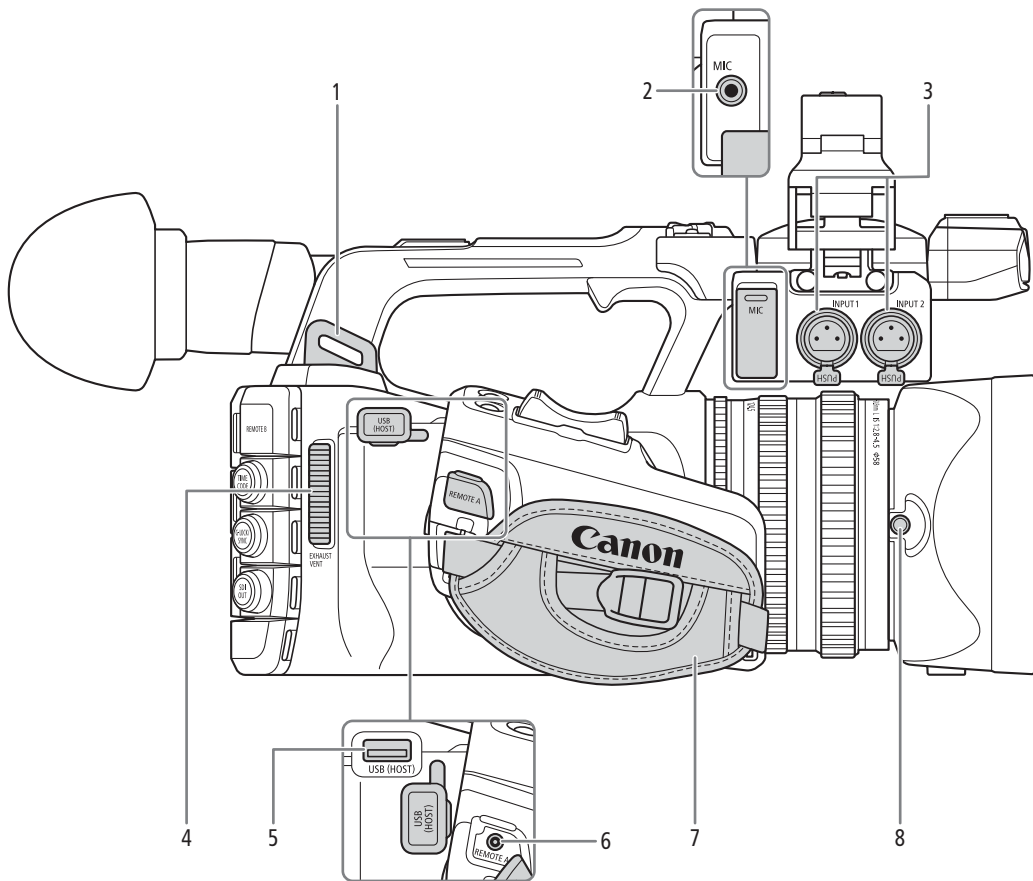

- 1 Strap mount
- 2 MIC (microphone) terminal (96)
- 3 INPUT 1/INPUT 2 terminal (XLR) (96)
- 4 Exhaust ventilation outlet (40)
- 5 USB (HOST) terminal
Used for future functionality expansion.
- 6 REMOTE A terminal
For connecting the RC-V100 Remote Controller (115) or commercially available remote controllers.

- 7 Grip belt

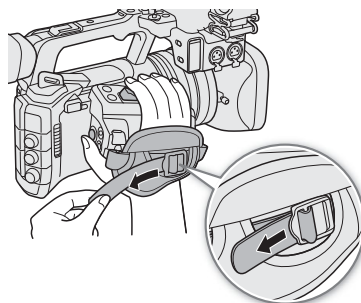

- 8 Lens hood lock screw (28)

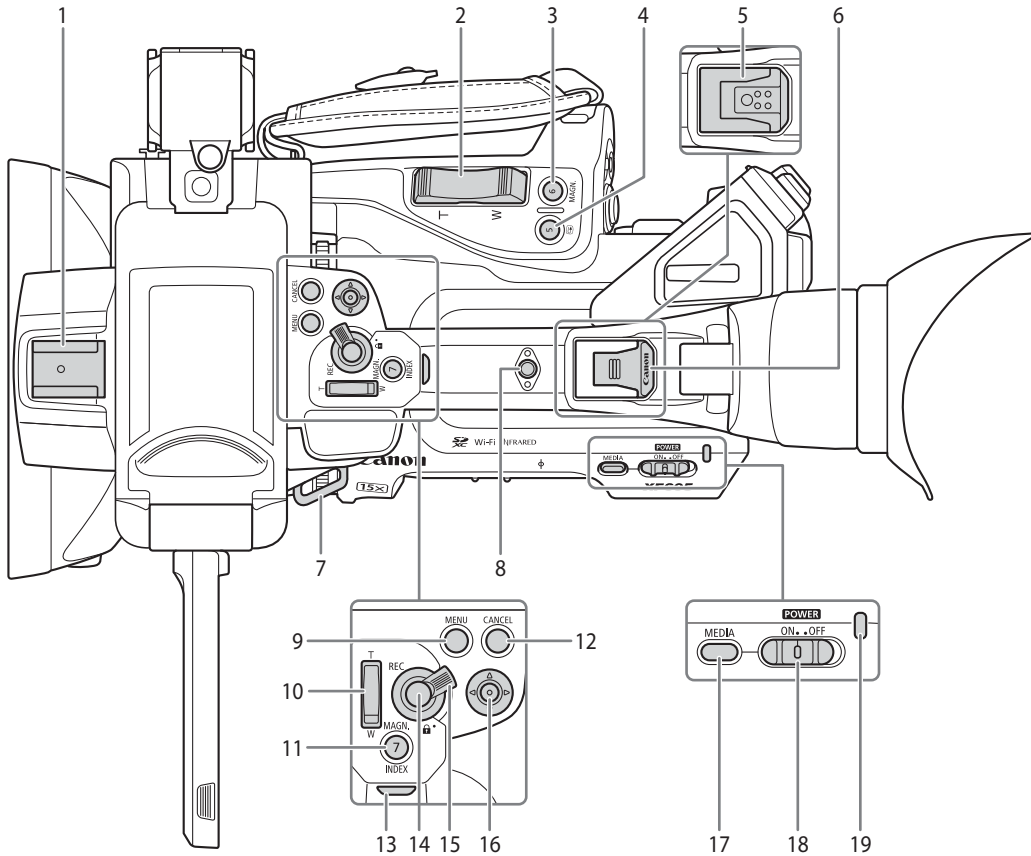

- 1 Accessory shoe
- 2 Grip zoom rocker (📖 73)
- 3 MAGN. (magnification) button (📖 78)/
Assignable button Camera 6 (📖 119)
- 4 (review recording) button (📖 49)/
Assignable button Camera 5 (📖 119)
- 5 Multi-function shoe (📖 30)
Using accessories with screws may damage the
multi-function shoe.
- 6 Multi-function shoe cover (📖 30)
- 7 Strap mount
- 8 Accessory socket
For mounting accessories with 1/4"-20 screws
(7.5 mm (0.30 in.) deep).
- 9 MENU button (📖 25)
- 10 Handle zoom rocker (📖 74)
- 11 MAGN. (magnification) button (📖 78)/
INDEX button (📖 136)/Assignable button
Camera 7 (📖 119)

- 12 CANCEL button (📖 25)
- 13 Rear tally lamp (📖 41)
- 14 REC (start/stop recording) button (📖 41)
- 15 Handle REC button's lock lever (📖 15)
- 16 Joystick (📖 25)
You can push the joystick in 4 directions (up/
down, left/right) and press the joystick itself to
confirm.
- 17 MEDIA (playback mode) button (📖 135)
When the camera is on, press to toggle the
camera between CAMERA mode (shooting) and
MEDIA mode (playback).
- 18 **POWER** switch (📖 41)
Set to ON to turn on the camera (the power
indicator illuminates in green) or to OFF to turn it
off (the power indicator goes out).
- 19 Power indicator

Locking the camera's controls (key lock)

In order to prevent accidental operations, you can set the lock lever (📖 14) or KEY LOCK switch to 🔒 (key lock) to lock all controls with the exception of the following.

- INFRARED switch
- REC button*
- Lens rings (focus, zoom, iris)

Set the lock lever (📖 14) or KEY LOCK switch back to 🔓 to reactivate the controls.

When the camera's controls are locked, you can still operate the camera using controllers (📖 115, 191), Browser Remote (📖 184), the Remote Camera Control Application (📖 191) or Multi-Camera Control (📖 192).

* You can also choose to lock REC buttons (📖 206).

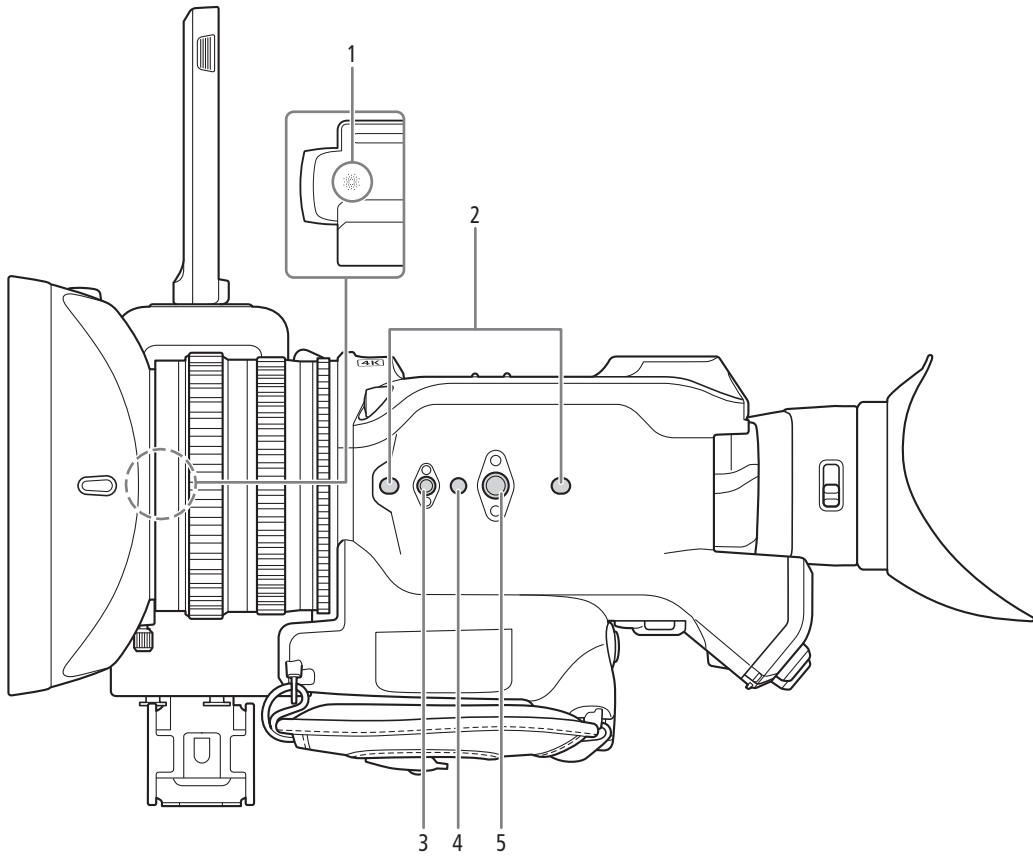

- | | |
|--|--|
| <p>1 Built-in speaker (📖 140)
Located below the space where the LCD monitor is stored.</p> <p>2 Socket for tripod's anti-rotation pin (5 mm (0.20 in.) deep, x2)
For tripods with 1/4"-20 mounting screws.</p> | <p>3 Screw hole for 1/4"-20 mounting screws (7.5 mm (0.30 in.) deep)</p> <p>4 Socket for tripod's anti-rotation pin (5.5 mm (0.22 in.) deep)
For tripods with 3/8"-16 mounting screws.</p> <p>5 Screw hole for 3/8"-16 mounting screws (10 mm (0.39 in.) deep)</p> |
|--|--|

! IMPORTANT

- Do not use tripods and other accessories with mounting screws exceeding the depth of the screw holes on the camera as this may damage the camera.
- Mounting the camera on a tripod using only one of the 1/4"-20 screw holes for tripod reinforcement may damage the camera.

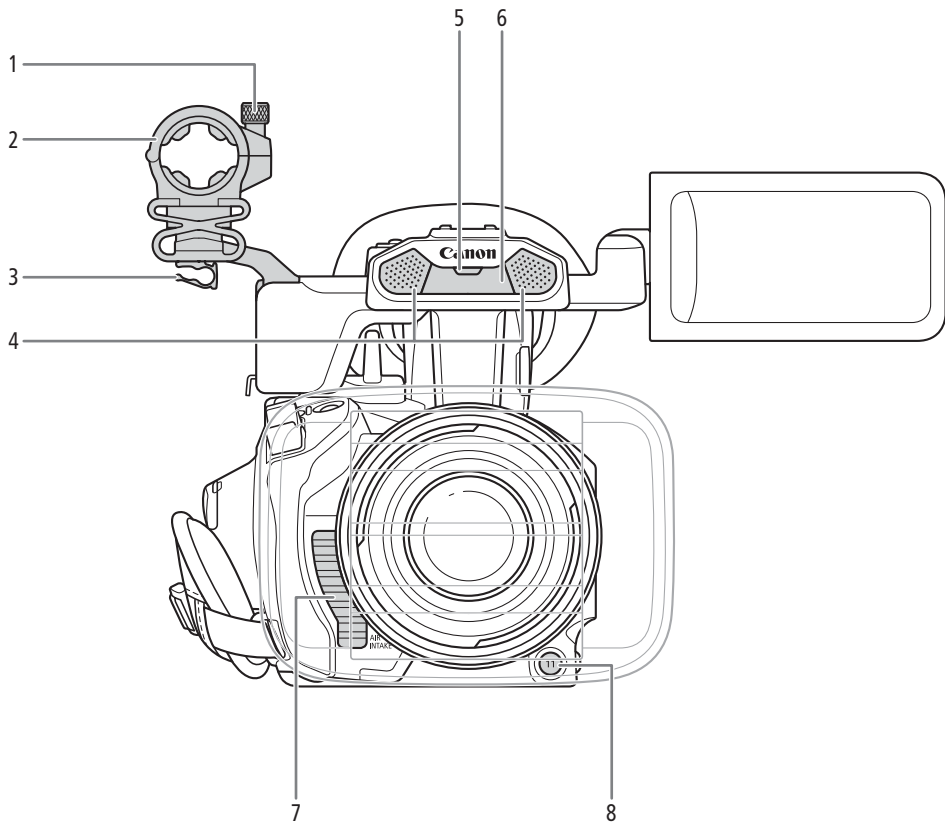

- 1 Microphone lock screw (📖 96)
- 2 Microphone holder (📖 96)
- 3 Microphone cable clamp (📖 96)
- 4 Built-in stereo microphone (📖 94)

- 5 Front tally lamp (📖 41)
- 6 Infrared light (📖 114)
- 7 Air intake vent (📖 40)
- 8 Assignable button Camera 11 (📖 119)

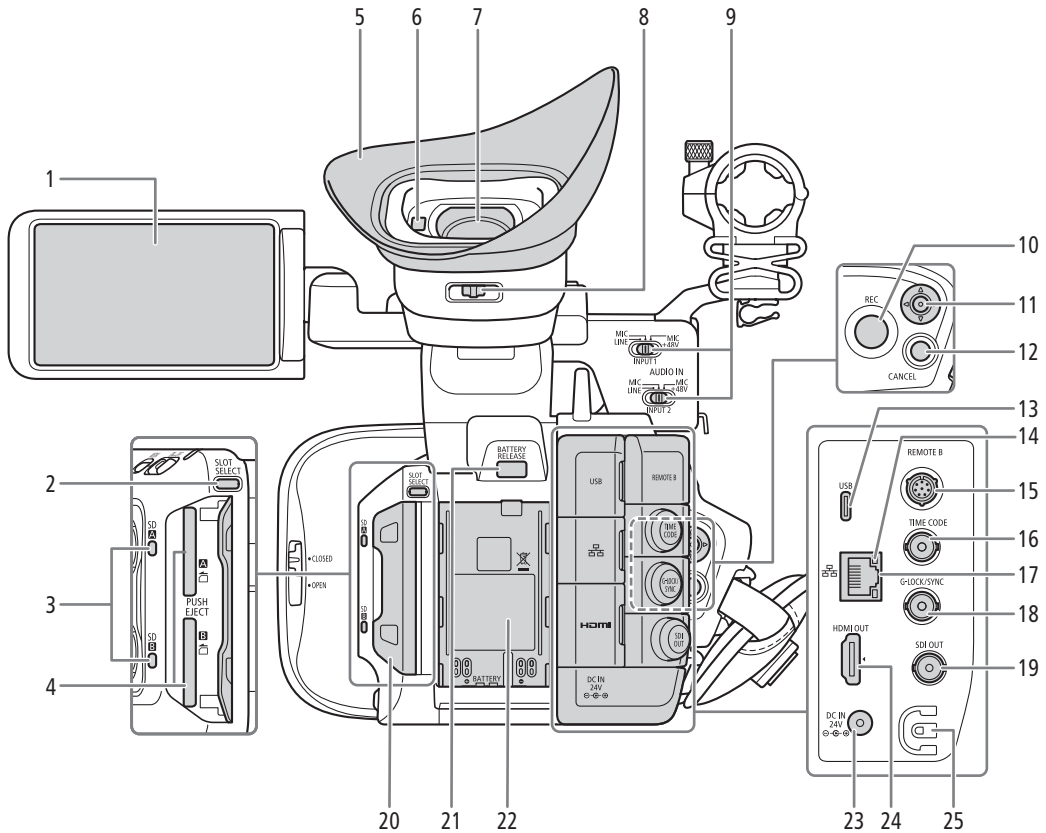

- | | |
|---|--|
| <p>1 LCD monitor with touch screen (23)</p> <p>2 SLOT SELECT (SD card selection) button (33)</p> <p>3 SD card access indicators (SD A/SD B) (32)</p> <p>4 SD card slots (32): SD CARD A (top) and SD CARD B (bottom)
In this manual, SD cards in each slot are referred to as "SD card A" and "SD card B", respectively.</p> <p>5 Eye cup (30)</p> <p>6 Eye sensor (29)</p> <p>7 Viewfinder (29)</p> <p>8 Dioptic adjustment lever (29)</p> <p>9 INPUT 1/INPUT 2 (audio input selection) switch (97)</p> <p>10 REC (start/stop recording) button (41)</p> <p>11 Joystick (25)
Can be pushed in 4 directions. You can also push the joystick itself to confirm a selection.</p> <p>12 CANCEL button (25)</p> | <p>13 USB terminal (Type-C) (117, 161)</p> <p>14 (Ethernet) indicator (165)</p> <p>15 REMOTE B terminal
For connecting the optional RC-V100 Remote Controller (115).</p> <p>16 TIME CODE terminal (91)</p> <p>17 (Ethernet) terminal (165)</p> <p>18 G-LOCK/SYNC terminal (92)</p> <p>19 SDI OUT terminal (145, 150)</p> <p>20 Card compartment covers (32)</p> <p>21 BATTERY RELEASE button (20)</p> <p>22 Battery compartment (20)</p> <p>23 DC IN terminal (22)</p> <p>24 HDMI OUT terminal (145, 151)</p> <p>25 DC cable clamp (22)</p> |
|---|--|

Removing and attaching the terminal covers

You can remove the covers of the camera's terminals to access them more easily. To remove a terminal's cover, open the cover and gently pull it straight out. To attach back the terminal cover, insert the connecting strip into the opening. If the connecting strip is difficult to grasp, use a pair of tweezers or similar tool.

Preparing the Power Supply

You can power the camera using a battery or a power outlet. Even when a battery is attached, if the camera is connected to a power outlet, it will not draw power from the battery.

Using a Battery

You can power the camera using the BP-A30 Battery Pack or the BP-A60 Battery Pack. Both battery packs are compatible with Intelligent System so you can check the approximate remaining battery usage time (in minutes) on the screen. For more accurate readings, when using a battery for the first time, charge it fully and then use the camera until the battery is completely depleted.

Charging the Battery

Charge battery packs using the CG-A20 Battery Charger and CA-CP200 L Compact Power Adapter. Before charging, remove the terminal cover of the battery pack.

- 1 Connect the AC adapter to the battery charger and plug the power cord into a power outlet.
- 2 Attach the battery to the battery charger.
 - Press lightly and slide the battery in the direction of the arrow until it clicks.
 - The CHARGE indicator starts flashing and also indicates the battery pack's approximate charge. The indicator will stay on when charging has completed.

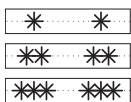
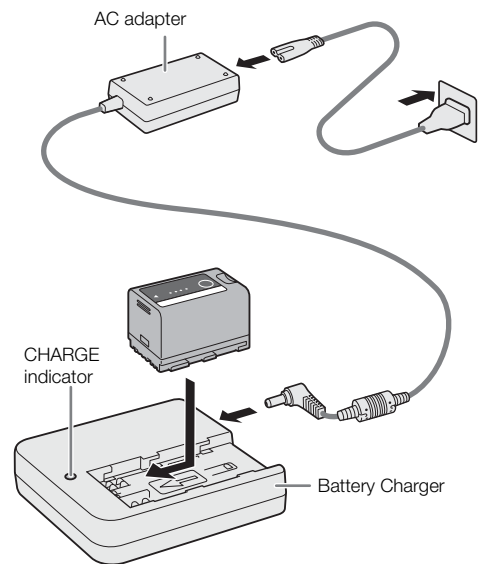

approx. 0% to 49%: Flashes once every 2 seconds

approx. 50% to 74%: Flashes twice every 2 seconds

approx. 75% to 99%: Flashes 3 times every 2 seconds

- 3 Disconnect the AC adapter from the battery charger and unplug the power cord.
- 4 Remove the battery from the battery charger.

! IMPORTANT

- Do not connect to the battery charger any product that is not expressly recommended for use with this camera.
- When using the battery charger or AC adapter, do not fix it permanently to one place as this may cause a malfunction.
- To prevent equipment breakdowns and excessive heating, do not connect the battery charger or AC adapter to voltage converters for overseas travels or special power sources such as those on aircraft and ships, DC-AC inverters, etc.

i NOTES

- We recommend charging the battery in temperatures between 10 °C and 30 °C (50 °F and 86 °F). Outside the temperature range of 0 °C to 40 °C (32 °F to 104 °F), charging will not start.
- If there is a malfunction with the battery charger, AC adapter or battery, the charge indicator will go out and charging will stop.
- For handling precautions regarding the battery, refer to *Handling Precautions* (📖 230).
- For approximate charging times / usage times, refer to the *Reference Tables* (📖 240) and *Approximate Continuous Recording Times* (📖 238).
- Charged batteries continue to discharge naturally. Therefore, charge them on the day of use, or the day before, to ensure a full charge.
- We recommend that you prepare batteries to last 2 to 3 times longer than you think you might need.
- Repeatedly charging and completely depleting a battery will eventually shorten its battery life. You can check the battery life on the [👉 System Setup] status screen (📖 213). Fully charging the battery and then depleting it completely will give you a more accurate reading.

Attaching the Battery

- 1 Turn off the camera.
- 2 Insert the battery all the way into the compartment as shown in the illustration and press it gently downwards until it clicks.

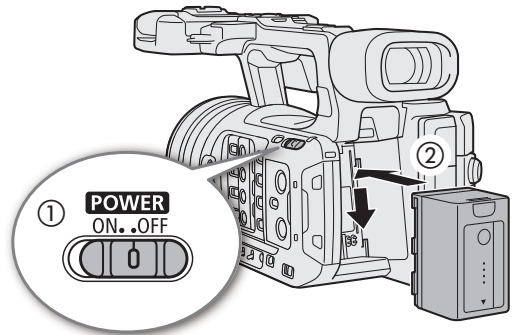

Removing the Battery

- 1 Turn off the camera.
- 2 Holding down the BATTERY RELEASE button (①), slide the battery upwards and then pull it out (②).

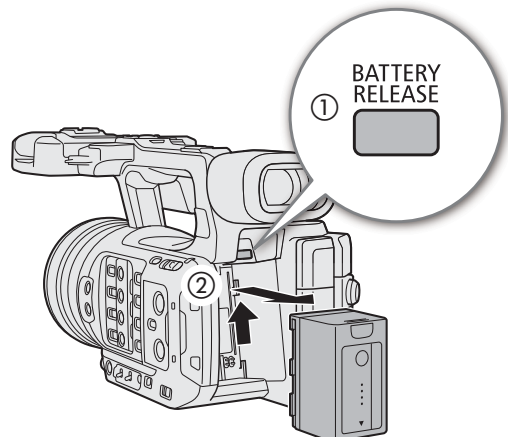

Checking the Remaining Battery Charge

When the camera is turned on, you can check the approximate remaining battery usage time (in minutes) by looking at any recording/playback screen or the [🔧 System Setup] status screen (📖 213). You can also check the approximate charge level on the battery itself.

Press the CHECK button on the battery. An indicator will light for approximately 3 seconds and show the approximate remaining battery charge.

☀️ ○ ○ ○	0-25%
☀️ ☀️ ○ ○	26-50%
☀️ ☀️ ☀️ ○	51-75%
☀️ ☀️ ☀️ ☀️	76-100%

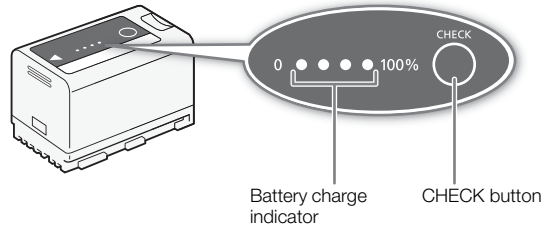

i NOTES

- The remaining battery charge level displayed in minutes on the screen may not match the [🔧 System Setup] status screen or the indicators on the battery pack.
- The effective usage time of the battery pack may decrease when using a bright screen setting, when recording in cold surroundings, etc.
- The camera's power consumption may vary depending on the usage conditions. When recording, it is recommended to prepare a battery charge level that allows for a longer recording time than planned (2 to 3 times).

Using a Power Outlet

You can also power the camera directly from a power outlet using the CA-CP200 L Compact Power Adapter (AC adapter). While the camera is powered using a power outlet, you can replace the battery pack even when the camera is turned on.

- 1 Connect the power cord to the AC adapter and plug it into a power outlet.
- 2 Connect the AC adapter's DC plug to the DC IN terminal on the camera.

! IMPORTANT

- Make sure to turn off the camera before connecting or disconnecting the AC adapter.
- When using the AC adapter, do not fix it permanently to one place as this may cause a malfunction.

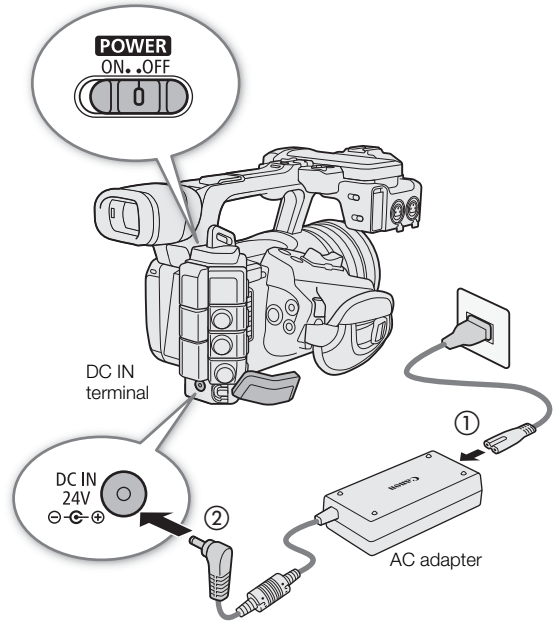

Preventing the accidental unplugging of the power cord

Pass the power cord through the clamp at the bottom of the camera as shown in the illustration to prevent the accidental unplugging of the DC plug.

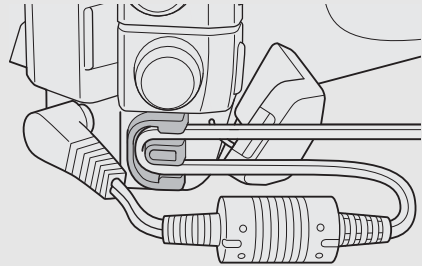

Checking the Voltage Level of the Power Source

The voltage level appears on the screen (📖 43). Select **MENU** > [Y System Setup] > [DC IN Warning (V)] to set a power warning level. When the voltage from the DC IN terminal reaches the set value, the onscreen voltage indicator will turn red and a warning will be displayed.

i NOTES

- The camera will not start recording if the voltage falls below the selected low-power warning level (📖 207). While shooting, the recording will be interrupted and the camera will turn off if the power voltage falls below the level required for the camera's operation.

Using the LCD Screen

This section explains how to adjust the LCD monitor. You can adjust the direction of the screen as shown below, as well as image settings such as brightness or contrast. Additionally, you can use the touch screen to select the subject or perform a variety of settings using direct touch control (50).

- 1 Open the LCD monitor 180 degrees (①) and adjust to the desired angle (②).
- 2 You can also place the LCD monitor so that it faces the subject.

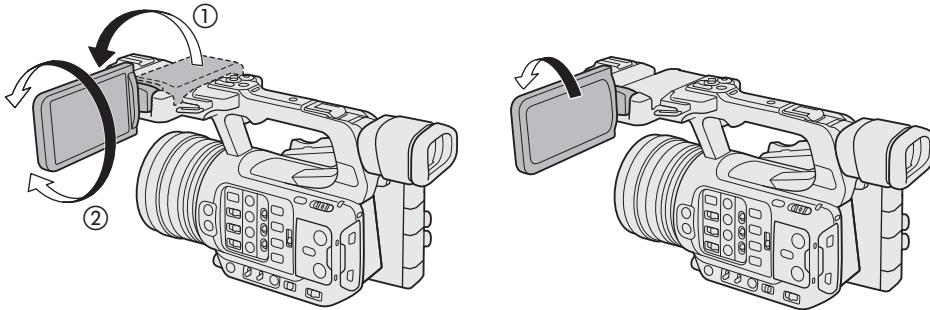

i NOTES

- You can adjust the brightness, contrast, color saturation, sharpness and luminance of the LCD screen with the respective settings in the **MENU** > [Monitoring Setup] menu (200). These settings do not affect the recorded video.
- In CAMERA mode, you can use the **MENU** > [Monitoring Setup] > [B&W Image: LCD] setting to change the image on the screen to black and white display. Even when the captured image is displayed in black and white, onscreen displays and icons will be shown in color.
- You can use the **MENU** > [System Setup] > [Touch Screen Response] setting to adjust the LCD monitor's response to touch input.
- When the LCD panel is rotated 180 degrees toward the subject, you can set **MENU** > [Monitoring Setup] > [LCD Mirror Image] to [On] to flip the image horizontally so it shows a mirror image of the subject.
- For details about how to take care of the LCD monitor, refer to *Handling Precautions* (230), *Cleaning* (232).

Date, Time and Language Settings

Setting the Date and Time

You will need to set the date and time on the camera the first time you power it on, or after the camera's settings have been reset. The [Date/Time] screen will appear automatically when the camera's clock is not set. Refer to *Using the Menus* (📖 25) for instructions on how to operate the menus.



1 Select the desired time zone* using the joystick, and confirm by pressing the joystick itself.

- The cursor will move to the next field.
 - You can also touch [▲]/[▼] on the screen to select the desired value.
 - You can also push the joystick left/right to move between the fields, or touch the desired field.
- * The default time zone is [UTC-05:00] (New York) or [UTC+01:00] (Central Europe), depending on the country/region of purchase. Time zones are based on Coordinated Universal Time (UTC).

2 Change the rest of the fields in the same way.

3 Select [Set] and then press the joystick.

- You can also touch the onscreen [Set] button to confirm, for example to match precisely a speaking clock or other signal.

NOTES

- You can display the date/time with the **MENU** > [📺 Monitoring Setup] > [Custom Display 2] or [Custom Display] > [Date/Time] setting.
- With the following settings, you can make changes after the initial setup. You can also change the date format and clock format (12 or 24 hours).
 - **MENU** > [🔧 System Setup] > [Time Zone], [Date/Time] and [Date Format]
- When you do not use the camera for about 3 months, the built-in backup battery may be depleted completely and the date and time setting may be lost. In such case, recharge the built-in backup battery (📖 231) and set the time zone, date and time again.
- Using the GP-E2 GPS Receiver, you can have the camera adjust settings automatically according to the UTC date/time information received from the GPS signal (📖 207).

Changing the Language

The camera's default language is English. You can change it to German, Spanish, French, Italian, Polish, Portuguese, Russian, Ukrainian, Simplified Chinese, Korean or Japanese. Please note that some settings and screens will be displayed in English, regardless of the language setting.

Refer to *Selecting an Option from the Menu* (📖 25) for details on how to navigate the menu to complete this procedure.

1 Select **MENU** > [🔧 System Setup] > [Language 🗨️].

2 Select the desired language and press the MENU button to close the menu.

Using the Menus

Many of the camera's functions can be adjusted using the menus. In CAMERA mode, you can also register frequently used menu settings in a customized menu (My Menu) for easy access. For details about the available menu options and settings, refer to *Menu Options* (📖 195).

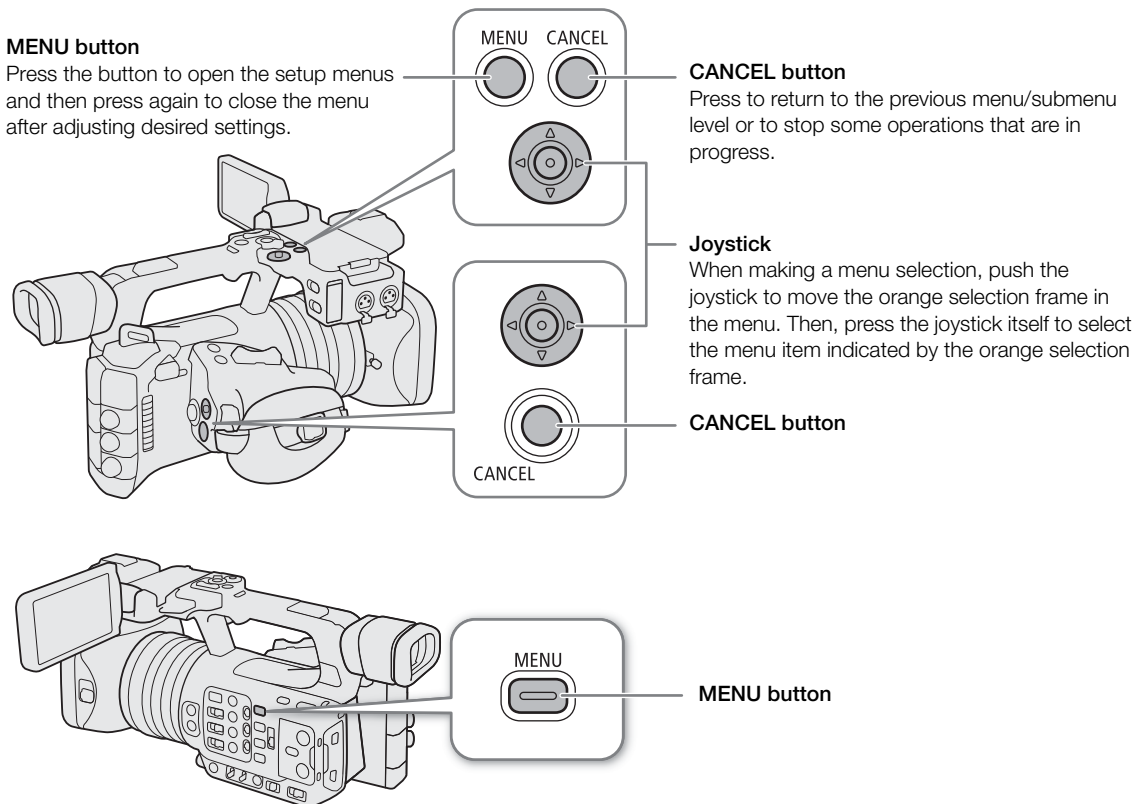

Selecting an Option from the Menu

The following is a step-by-step explanation of how to select a typical option from the setup menu. Some menu items may require additional steps. Such operations will be explained in the respective section of the manual. For brevity's sake, references to menu settings throughout the manual will be abbreviated as follows:

MENU > [🔧 System Setup] > [Language 🗣️] > Desired option

1 Press the MENU button.

- The menu opens. The icon displayed in orange is the menu item that was selected the last time the menu was closed (unless the camera was turned off).
- When a menu icon is not selected, first push the joystick up or press the CANCEL button to move the orange selection frame to one of the icons.

2 Push the joystick left/right to select the icon of the desired setup menu.

- You can also touch the desired menu icon.

3 Press the joystick to confirm your selected setup menu.



- The cursor moves to the first item on the first page of the selected setup menu.
- You can also push the joystick down to move the cursor to the list of menu items.

- You can also touch the desired page or menu item.
- Going forward, this operation will be referred to as “press SET” in this manual.

4 Select the desired menu item ([Language , in the example) and then press SET.

- Push the joystick left/right to scroll through the menu pages. Moving left/right from the first/last page will move to the previous/next setup.
- Push the joystick up/down to move the cursor over the menu items on the page.
- You can also drag the screen left/right to navigate pages, or drag the screen up/down to move the orange selection frame. You can also select a menu item by lifting your finger when you get to the desired item.





5 Push the joystick up/down to select the desired setting option and then press SET.

- During the selection, the currently selected option is indicated with a  mark. Press SET to confirm your selection and go back to the previous screen.
- When many options are available, a scroll bar will appear on the right. Scroll up or down to see other options.
- You can also touch the desired option.
- Press the CANCEL button or select [] and press SET to return to the previous menu level.

6 Press the MENU button to close the menu.

- Pressing the MENU button at any time closes the menu.

NOTES

- Unavailable items may appear grayed out.
- On some screens, the following icons may be displayed as a guide: , , . They refer, respectively, to pressing the joystick, the MENU button (or touching the onscreen guide) and the CANCEL button.
- When an RC-V100 Remote Controller is connected to the camera, you can use the remote controller's up/down/left/right/SET buttons in the same way as the camera's joystick. Pressing the SET button is equivalent to pressing the joystick itself to confirm a selection.
- You can check most of the current settings on the status screens ( 208).



Using the Customized Menus (My Menu)

In CAMERA mode, you can register up to 6 frequently used menu settings under a My Menu page for easy access. You can save up to 5 separate sets of My Menu settings each with 6 options for different shooting situations. Furthermore, if you set an assignable button to [My Menu] ( 119), you can press the button to access your registered menu settings even faster and more easily.

Adding Menu Settings

- 1 Select **MENU** > [ My Menu] > Desired menu page > [Edit] > [Register].
 - A screen will appear where you can select the menu setting you want to add.
 - Press the CANCEL button to cancel the operation and return to the regular menu.
- 2 Select the menu setting you want to add.
- 3 Select [OK].
 - The menu setting you registered will now appear under the currently selected My Menu set.

Rearranging Menu Settings

- 1 Select **MENU** > [ My Menu] > Desired menu page > [Edit] > [Move].
- 2 Select the menu setting you want to move.
 - The  icon will appear next to the setting you selected to move.

3 Move the menu setting to the desired position and press SET.

Removing Menu Settings

- 1 Select **MENU** > [★ My Menu] > Desired menu page > [Edit] > [Delete].
- 2 Select the menu setting you want to remove and then select [OK].

Resetting All the My Menu Sets

Reset all the menu settings registered to the currently selected My Menu set.

Select **MENU** > [★ My Menu] > Desired menu page > [Edit] > [Reset All] and then select [OK].

Renaming My Menu Sets

You can give each of the 5 My Menu sets a more descriptive name to make them easier to identify.

- 1 Select **MENU** > [★ My Menu] > Desired menu page > [Edit] > [Rename].
- 2 Enter the desired name (8 characters long) using the keyboard screen (see the following sidebar).

Entering text and numbers

There are two types of screens used to enter text and numbers – the keyboard screen, and the data entry screen. Which screen is used, as well as the available characters will depend on the menu setting.

Keyboard screen

- 1 Touch the character you wish to enter.
 - The characters you entered will appear in the input area at the top of the screen.

Key	Function
← / →	Moves the cursor in the input area.
↑	Shift key
🔑 / A↔1	Switches between letters, numbers and special characters.
␣	Space key
⌫	Backspace key



- You can also move the cursor with the joystick, and select the desired character by pressing SET.

2 After entering the desired text, touch [OK] to confirm.

Data entry screen

Use the joystick to select characters.

- 1 Select a character and then press SET to confirm.
 - The cursor will move to the next field.
 - You can also push the joystick left/right to move between the fields.
 - You can also touch the ▲/▼ buttons on the screen to select the desired character, or move the cursor by touching the character itself.
 - Change the rest of the characters in the same way.
- 2 Select [Set] to confirm the text or value.
 - You can also confirm your selection by touching the onscreen SET button.
 - Press CANCEL to stop entering text.

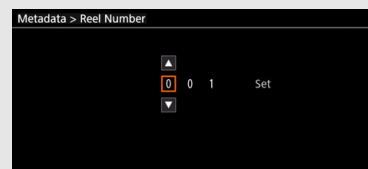

Preparing the Camera

This section details how to prepare the camera for the first time, including how to attach the microphone holder and the lens hood, as well as how to adjust the viewfinder.

Attaching the Microphone Holder

To the Right Side of the Handle Unit

- 1 Attach the microphone holder to the handle unit.
- 2 Use a commercially available Phillips head ("crosshead") screwdriver to secure it firmly with the 2 M4 bolts.

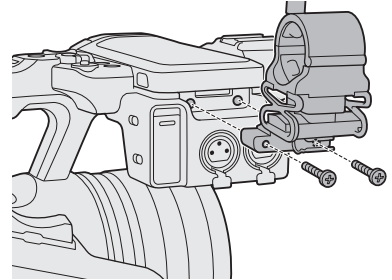

Attaching the Lens Hood

Attach the lens hood to protect the lens and reduce the amount of stray light that may hit the lens. Additionally, keeping the lens barrier closed can help avoid fingerprints and dirt on the lens. Always remove the lens hood and attach the lens cap when carrying the camera or storing it after use.

- 1 Remove the lens cap.
 - The lens cap and lens hood cannot be used at the same time.
- 2 Place the lens hood on the front of the lens with the lock screw side pointing down (①) and turn it 90 degrees clockwise (②).
 - Be careful not to deform the lens hood.
 - Make sure that the lens hood is aligned with the thread.
- 3 Tighten the lock screw (③).

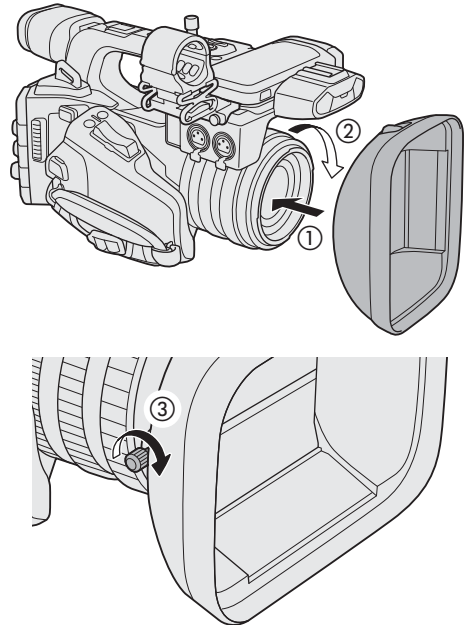

Lens Diffraction Correction

The image produced may not be as sharp at certain apertures (lens diffraction), in which case, you can apply a correction to compensate as necessary.

- 1 Turn on the camera in CAMERA mode.
- 2 Select **MENU** > [**📷** Camera Setup] > [Diffraction Correction] > [On].
 - The camera will apply the correction for the attached lens to all future recordings.

Using the Viewfinder

The camera's viewfinder features an OLED screen that turns on automatically when you look through the viewfinder and turns off shortly after you move your eye away from it.

Adjusting the Viewfinder

- 1 Adjust the viewfinder's angle as necessary.
- 2 Turn on the camera and adjust the dioptic adjustment lever until the viewfinder's image is sharp.

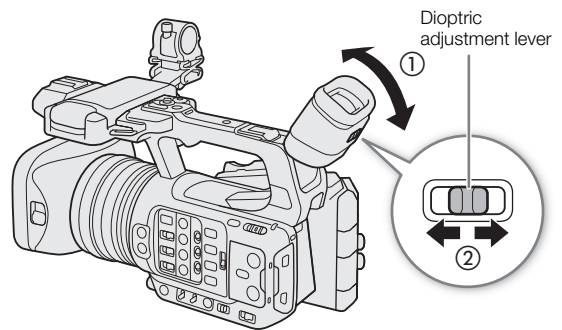

i NOTES

- You can adjust the brightness, contrast, color saturation, sharpness and luminance of the viewfinder with the respective settings in the **MENU** > [**📷** Monitoring Setup] menu (📖 200). These settings do not affect the recorded video.
- In CAMERA mode, you can use the **MENU** > [**📷** Monitoring Setup] > [B&W Image: VF] setting to change the image on the screen to black and white display. Even when the captured image is displayed in black and white, onscreen displays and icons will be shown in color.
- You can turn on the viewfinder permanently by setting **MENU** > [**📷** Monitoring Setup] > [VF Eye Sensor] to [Off].

Reducing the Viewfinder's Image Shaking

You can reduce the image shaking on the viewfinder caused when the set frame rate is low, and the camera is moved horizontally.

Select **MENU** > [**📷** Monitoring Setup] > [Run VF at x2 Speed] > [On].

i NOTES

- **The [Run VF at x2 Speed] setting cannot be used in the following cases.**
 - When the recording mode is set to an option other than normal recording or pre-recording.
 - When the frame rate is set to an option other than 29.97P / 25.00P / 23.98P.
 - In MEDIA mode.
- The [Run VF at x2 Speed] setting cannot be changed while you are recording (while [● REC] appears on the screen).

Attaching and Removing the Eye Cup

Attach the eye cup so that it covers the rubber rim of the viewfinder unit. To remove the eye cup, pull it gently in a “peeling off” motion from the bottom up.

- For left eye use, attach the eye cup so that the protruding part faces the opposite side.

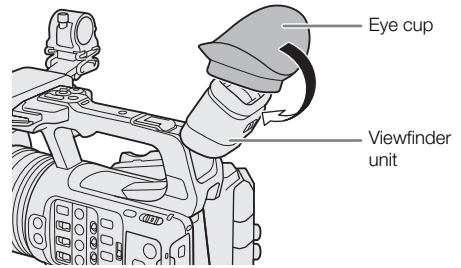

! IMPORTANT

- Pointing the viewfinder lens at the sun or other strong light sources may cause damage to internal components. When you are not using the viewfinder, make sure to attach the viewfinder cap to the viewfinder. This will also protect the viewfinder from scratches and dirt. Attach the viewfinder cap by inserting it into the rubber rim of the viewfinder unit.

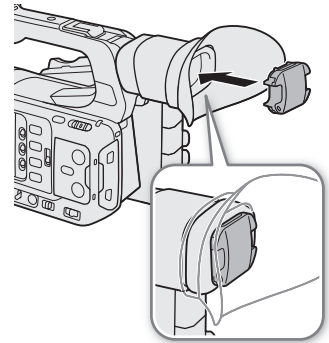

Attaching an Accessory Compatible with the Multi-Function Shoe

For details on how to attach and use accessories, refer to the instruction manual of the accessory in use.

Remove the multi-function shoe cover (①) and slide the accessory's connecting terminal into the multi-function shoe (②).

- When attaching accessories that communicate through contacts of the multi-function shoe, insert the accessory's mounting foot until it clicks into place, then slide the mounting foot locking lever to secure it.

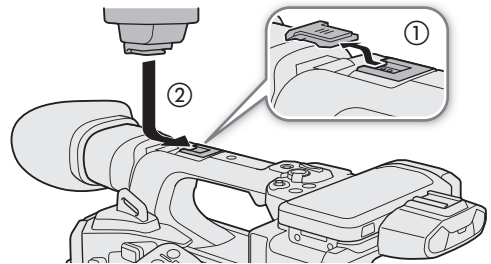

! IMPORTANT

Protecting the multi-function shoe:

- After removing accessories from the multi-function shoe, reattach the shoe cap to protect the contacts from dust and water.
- Blow off any foreign material on the multi-function shoe with a commercially available blower or similar tool.
- Allow the multi-function shoe to dry before use if it gets wet.

i NOTES

- The Electronic Viewfinder EVF-DC2/EVF-DC1 cannot be attached to the multi-function shoe. Attempting to attach it by force may damage it or the multi-function shoe.

Preparing Recording Media

The camera records clips, photos and other files on SD cards*. The camera has two card slots, and recording on two cards is possible (📖 35).



Initialize cards (📖 32) when you use them with this camera for the first time.

* The SD card is used also to save/read other files such as custom picture files.

Compatible Recording Media

The following types of memory card can be used with this camera. For the latest information about recording media tested for use with this camera, visit your local Canon website.

SD cards

SD card type:	 SD cards,  SDHC cards,  SDXC cards
UHS Speed Class*:	U3
Video Speed Class*:	V30, V60, V90

* UHS and Video Speed Class are standards that indicate the minimum guaranteed data transfer rate of SD cards.

Recommended speed class by video configuration

Video configuration			Bit rate	Frame rate	Recommended speed class
Recording mode	Recording format	Resolution			
Slow & fast motion recording	–	–	–	–	V90
Other recording modes	XF-AVC YCC422 10 bit	3840x2160	Intra-frame	59.94P 50.00P	V90
				Other than the above	V60, V90
		Long GOP	–	V60, V90	
	1920x1080	Intra-frame	–	V60, V90	
	MP4 (HEVC) YCC422 10 bit	3840x2160	–	–	V60, V90

! IMPORTANT

- After repeatedly recording, deleting and editing clips (if the memory is fragmented), you may notice slower writing speeds to the card and recording may even stop. In such case, save your recordings and initialize the card with the camera. Be sure to initialize cards especially before shooting important scenes.
- **About SDXC cards:** You can use SDXC cards with this camera but these cards are initialized by the camera using the exFAT file system.
 - When using exFAT-formatted cards with other devices (digital recorders, card readers, etc.), make sure that the external device is compatible with exFAT. For more information on compatibility, contact the computer, operating system or card manufacturer.
 - If you use exFAT-formatted cards with a computer OS that is not exFAT-compatible, you may be prompted to format the card. In such case, **cancel the operation to prevent data loss.**

i NOTES

- Proper operation cannot be guaranteed for all cards.

Inserting and Removing an SD Card

- 1 Wait until the SD CARD access indicator is off or is illuminated in green.
- 2 Open the card compartment cover.
- 3 Insert the card straight, with the label facing the side of the operation buttons, into the SD card slot until it clicks.
 - You can use two cards, one in each card slot.
 - To remove the card, make sure the SD CARD indicator is off and then push the card once to release it. When the card springs out, pull it all the way out.
- 4 Close the card compartment cover.
 - Do not force the cover closed if the card is not correctly inserted.

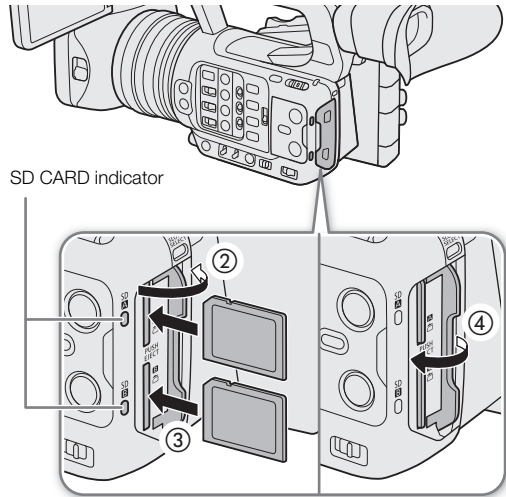

SD card access indicator

Indicator	Card status
Red	Accessing the card.
Green	Recording/playback is possible and the card is selected for recording/playback.
Off	A card is not inserted or the card slot is not currently selected.

If you set **MENU** > [🔧 System Setup] > [SD Card Access LED] to [Off], the SD card access indicator will not illuminate.

! IMPORTANT

- SD cards have front and back sides that are not interchangeable. Inserting a card facing the wrong direction can cause a malfunction of the camera. Be sure to insert the card as shown in the illustration.

Initializing Cards

Initialize cards when you use them with this camera for the first time. You can also initialize a card to permanently delete all the recordings it contains.

- 1 Select **MENU** > [🔧 Recording/Media Setup] > [Initialize Media].
- 2 Select the desired card.
- 3 Select [OK].
 - The card is initialized and all the data it contains is erased.

! IMPORTANT

- SD cards are initialized using the FAT file system, SDHC cards using the FAT32 file system, and SDXC cards using the exFAT file system.
- Initializing a card will permanently erase all data, including photos and protected custom picture files. Lost data cannot be recovered. Make sure you save important recordings in advance.
- Depending on the card, initialization may take up to a few minutes.

i NOTES

- If you set an assignable button to [Initialize Media] (📖 119), you can press the button to open the [Initialize Media] submenu.

Setting a Card's Volume Label

You can set the volume label for SDXC cards used for recording (only in CAMERA mode, when recording XF-AVC clips), in order to make it easier to identify and organize them later.

- 1 Select **MENU** > [📷 Recording/Media Setup] > [Volume Label] > Desired option.
- 2 Initialize the card (📖 32).
- 3 If necessary, set the XF-AVC clip file name's metadata elements (📖 37).
- 4 Record clips on the card.
 - The card's volume label changes when the first XF-AVC clip is recorded on a just initialized card.

Options

[Canon]: The card's volume label will be "CANON" regardless of the clip file name settings.

[Canon + Metadata]:

The card's volume label will be "CANON", plus the camera index number and the reel number (📖 37).

Switching Between Card Slots

If both slots contain a card, you can switch the card used for recording/playback as necessary.

Press the SLOT SELECT button.

- The access indicator of the selected SD card slot will illuminate in green.

i NOTES

- You cannot use the SLOT SELECT button to switch between card slots while recording or playing back.
- You can also perform this function remotely using Browser Remote (📖 186).

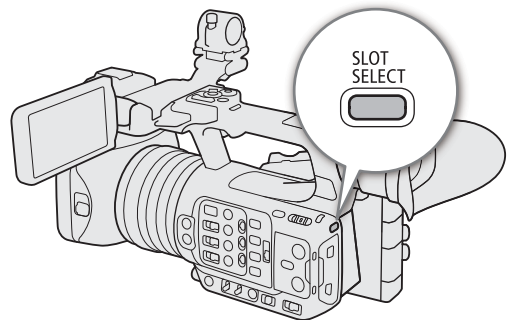
**Checking the Remaining Recording Time on a Card**

The display on the upper left of the screen shows the card icons and the remaining recording time* (in minutes) on each card (📖 44).

On the [📷 Recording/Media Setup] status screen (📖 214), you can check the total space, used space and approximate remaining recording time* of each card. The approximate remaining number of photos (SD card B only) and speed class will be displayed as well.

* Remaining recording times are approximate and calculated based on the current video configuration used.

Recovering Recordings

Some actions, such as suddenly turning off the camera or removing the card while data is being recorded, can cause data errors in the recorded file. You may be able to recover recordings with corrupted data using the following procedure.

- 1 Switch to MEDIA mode and open the index screen with the recordings you wish to recover (📖 135).
- 2 Select the desired recording (with the ? icon).
- 3 Press SET to open the file menu and select [Recover] > [OK].
 - The camera will attempt to recover the corrupted data.

NOTES

- The file may not be recorded if the power is cut or if the SD card is removed immediately after starting recording. Even if a partial recording was made, such files may be deleted if file recovery is attempted.
- In some cases, it may not be possible to recover the data. This is more likely when the file system is corrupted or the card is physically damaged.
- Only clips, WAV files and News Metadata files recorded with this camera can be recovered. Chunk recording clips (including News Metadata) and photos cannot be recovered.

Selecting the Video Recording Method

This camera features various recording modes, as well as video recording methods using two cards. You can also stream the audio/video while recording it on a card (📖 182). Below is an overview. For details, refer to each function's section.

Recording modes

You can select the video recording method for the card selected for recording.

[Recording Mode]	Description	📖
[Normal Recording]	Normal recording. Records a clip in the selected recording format. The most basic video recording method.	41
[Slow & Fast Motion], [S&F Clip / Audio (WAV)]	Slow & fast motion recording. Records using a frame rate that is different from the playback frame rate (overcrank/undercrank shooting). Audio (WAV) can also be recorded.	109
[Pre-Recording]	Pre-recording. Records onto a temporary memory (3 seconds) so the clip will contain a few seconds of video and audio recorded before you perform the recording operation.	111
[Frame Recording]	Frame recording. Records a pre-defined number of frames. Sound is not recorded in this mode.	111
[Interval Recording]	Interval recording. Automatically records a pre-defined number of frames at a pre-defined interval. Sound is not recorded in this mode.	112
[A Main / B Continuous Rec]	Continuous recording. SD card A is used for normal recording, and SD card B is used for continuous recording.	113

Second card recording functions

These are the recording methods for the other SD card.

[2nd Card Rec Functions]	Description	📖
[A Main / B Proxy Rec]	Proxy recording. Simultaneously records a proxy clip (to SD card B, while the main clip is recorded to SD card A) with a smaller file size for offline editing. The proxy clip is recorded with a file name associated with the main clip.	55
[A Main / B Chunk Rec]	Chunk recording. Simultaneously records the main clip to SD card A, and a clip divided in chunks (suitable for automatic transfer) to SD card B.	57
[A Main / B Sub Rec]	Sub recording. Simultaneously records a clip to SD card B with a different video configuration from that of the main clip on SD card A.	58
[A Main / B Audio Rec]	Audio recording. Simultaneously records a WAV file* to SD card B, while the main clip is recorded to SD card A. * Differs from the WAV files that can be recorded together with slow & fast motion recording.	95
[Relay Recording]	Relay recording. Continues recording on the other card without interruption when the card you are using becomes full. It is available from SD card A to SD card B and vice versa.	–
[Double Slot Recording]	Double slot recording. Records the same clip simultaneously to both cards, which is a convenient way to make a backup copy of your recordings.	–

1 Select the recording mode

- Use direct touch control (📖 50) or in the menu, select **MENU** > [ Recording / Media Setup] > [Recording Mode] > Desired option.

2 Select the second card's recording function

- Use direct touch control (📖 50) or in the menu, select **MENU** > [ Recording / Media Setup] > [2nd Card Rec Functions] > Desired option.

Available simultaneous recording configurations

		Second card recording function					
		Off	Proxy Recording/ Chunk Recording	Sub Recording	Audio Recording	Relay Recording	Double Slot Recording
Recording mode	Normal Recording	●	●	●	●	●	●
	Slow & Fast Motion Recording	●	–	–	–	–	–
	Pre-recording	●	●	●	–	●	●
	Frame Recording	●	–	–	–	●	●
	Interval Recording	●	–	–	–	●	●
	Continuous Recording	●	–	–	–	–	–

- Simultaneous recording is available only with normal recording while connected to a network with IP streaming activated.

i NOTES

- It is not possible to switch between card slots when proxy recording, chunk recording, sub recording, audio recording or continuous recording is activated.
- If a card becomes full during double slot recording, recording on both cards will stop. On the other hand, if an error occurs with one of the cards, recording will continue on the other card.

Setting the File Name for Recordings

This section explains how to set the file names for XF-AVC clips, MP4 clips and photos.

XF-AVC Clips File Names

The camera allows you to change several settings that determine the clip file name of recorded XF-AVC clips (only in CAMERA mode). For more details on how to enter characters, see *Entering text and numbers* (📖 27).

The basic file name structure is as follows.

A 0 0 1 C 0 0 1 _ y y m m d d X X _ C A N O N _ 0 1 P

1
2
3
4
5
6
7

- 1 **Camera index:** One character (A to Z) that identifies the camera used.
 - 2 **Reel number:** 3 characters (001 to 999) that identify the card used. The number is assigned automatically but you can set the initial number. After you insert a new card (just purchased or initialized), the number advances by one when the first recording is made.
 - 3 **Clip number:** 4 characters (C001 to D999). The clip number advances automatically with each clip recorded (switching to D001 after C999), but you can set the initial clip number and select the clip numbering method.
 - 4 Recording date (set automatically by the camera).
 - 5 Random component: 2 characters (numbers 0 to 9 and capital letters A to Z) that change randomly with each clip.
 - 6 **User defined field:** 5 characters (numbers 0 to 9 and capital letters A to Z) for any other identification purposes.
 - 7 Proxy clips only: The camera will automatically add the suffix "_Proxy" or "_P" to the file name of proxy clips (📖 38). Additionally, when an SD or SDHC card is used to record proxy clips, a stream number (01 to 99) will be added before "_Proxy" or "P". The stream number will advance every time the video (stream) file within the clip is split and recording continues on a separate stream file.
- Apart from the suffix "_Proxy" or "_P" in component number 7, the file name of the primary clip and the proxy clip will be identical.
 - Apart from component number 2, the file name of the primary clip and the sub recording clip will be identical.
 - The file name of double slot recording clips will be the same on both SD cards.
 - Apart from component number 7 and the .WAV extension, the file name of the WAV files recorded during slow & fast motion recording or the second card recording functions will be the same as that of the main clip, and will be saved on the "/PRIVATE/AUDIO" folder.

To set the camera index

Select **MENU** > [📷 Recording/Media Setup] > [Metadata] > [Camera Index] > Desired camera index (📖 27).



To set the clip numbering method

Select **MENU** > [📷 Recording/Media Setup] > [Metadata] > [Clip Numbering] > [Reset] or [Continuous].



Options

- [Reset]: The clip number will restart from 001 every time you insert a new card.
- [Continuous]: Clip numbers will start from the initial number set with [Clip Number] (following procedure) and continue across multiple cards.

To set the reel number or initial clip number

- 1 Select **MENU** > [ Recording/Media Setup] > [Metadata] > [Reel Number] or [Clip Number] > [Change].
 - To return to initial settings, select [Reset] instead.
- 2 Enter the reel/clip number using the data entry screen ( 27).

To set the user-defined field

- 1 Select **MENU** > [ Recording/Media Setup] > [Metadata] > [User Defined] > [Change].
 - To return to initial settings, select [Reset] instead.
- 2 Enter the desired text string using the data entry screen ( 27).

To set the file naming method for proxy clips

Select the string to be added automatically to the end of the file name for proxy clips.

Select **MENU** > [ Recording/Media Setup] > [Metadata] > [Stream Number/Proxy] > [01_Proxy] or [_01P].

MP4 Clip and Photo Numbering

MP4 clips and photos are automatically assigned consecutive numbers and stored on the SD card in folders. You can select the numbering method to be used.

MP4 clip/photo folder names and file names

MP4 clip/photo number

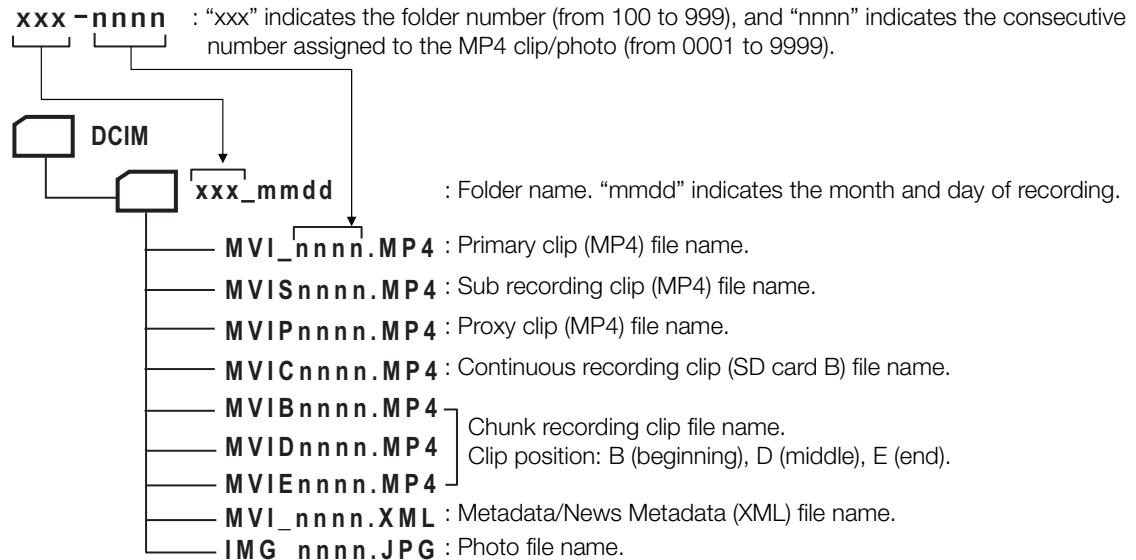

- For sub recording clips, the folder name and consecutive number (“nnnn”) will be the same in both SD cards.
- For double slot recording clips, the folder name and file name will be the same in both SD cards.
- The WAV files recorded during slow & fast motion recording will have the same file name as that of the primary clip with the addition of “_yyyymmddHHMMSS” (year, month, day, hour, minute, second), and will be stored in the “/PRIVATE/AUDIO/” folder of the card.

- The WAV files recorded when using the second card recording functions will be stored in the “/PRIVATE/AUDIO/” folder of the card.
The file name is set as follows: file name of the primary clip (MVI_nnnn) + “_yyymmddHHMMSS” (year, month, day, hour, minute, second) + proxy identifier* + “.wav”.
* “_P” or “_Proxy” depending on the [Stream Number/Proxy] setting (☐ 199) on the menu.
- The “MVIP” part of metadata/News Metadata (XML) file names may also be “MVIS”, “MVIC”, “MVIB” or “MVIE”.

Select **MENU** > [ Recording/Media Setup] > [MP4 Clip/Photo Numbering] > Desired option.

Options

- [Reset]: Recording numbers will restart from 100-0001 every time you insert a new card. If a card already contains previous recordings, numbers will continue from the number following that of the last MP4 clip/photo on the card.
- [Continuous]: Recording numbers will continue from the number following that of the last MP4 clip/photo recorded with the camera. This setting is the most convenient for managing files on a computer. We recommend using the [Continuous] setting.

NOTES

- Each folder can contain up to 500 files. When that number is exceeded, a new folder is created automatically.

Using the Fan

The camera uses a cooling fan to lower the camera's internal temperature. In CAMERA mode, you can change the fan's operation mode from the menu. In MEDIA mode, the fan runs at all times.

Setting the Fan's Operation in CAMERA Mode

1 Select **MENU** > [ System Setup] > [Fan Mode] > Desired option.

Options for [Fan Mode]

[Automatic]: The fan runs while the camera is not recording and is automatically turned off while the camera is recording. However, if the internal temperature of the camera is too high, the fan will be activated automatically (in that case, **FAN** will appear). When the camera's temperature has decreased sufficiently, the fan will be turned off. Use this setting when you do not want the camera to pick up the fan's operating sound.

[Always On]: The fan runs at all times.

IMPORTANT

- While the fan is running, the exhaust vent will emit warm air.
- Be careful not to obstruct in any way the fan's air vents ( 13).

NOTES

- Depending on the ambient temperature and other shooting conditions, the fan may not turn off even if you set its operating mode to [Automatic].

Recording Video and Photos

This section explains the basics of recording clips* and photos. For details on recording audio, refer to *Recording Audio* (📖 94).

* “Clip” refers to a single movie unit recorded with a single recording operation. You can also include metadata and News Metadata (📖 107) with the clip.

Recording

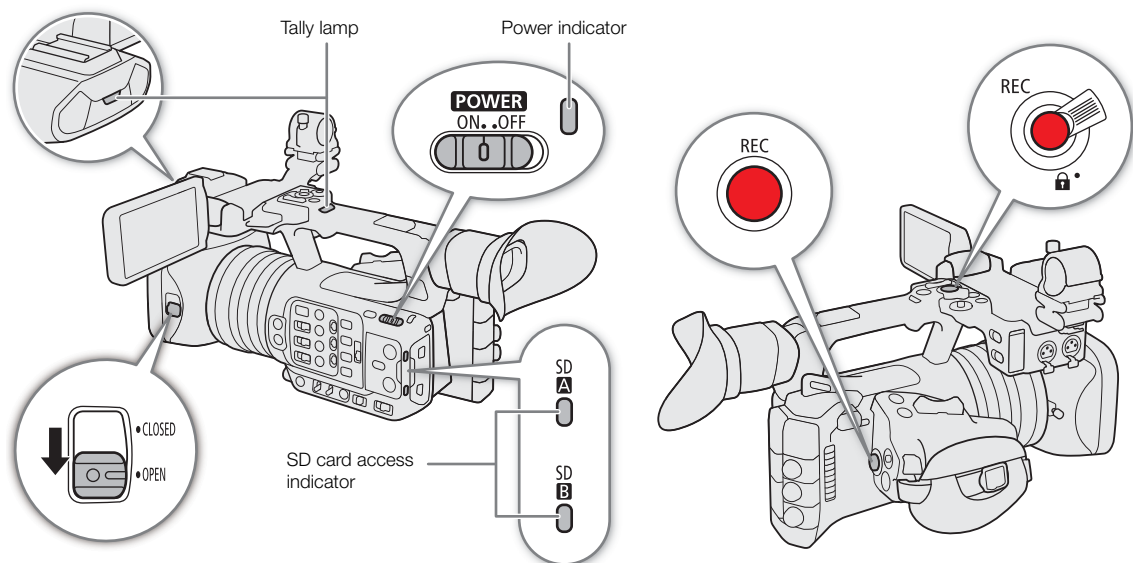

1 Open the lens barrier.

2 Press the **POWER** switch and set it to ON.

- The camera turns on in CAMERA mode and enters record standby mode ([STBY]). The power indicator illuminates in green.
- The access indicators of card slots with a card inserted will illuminate momentarily in red. Then, the access indicators of cards selected for recording will change to green.

3 Press the REC button to begin recording.

- Recording starts. The tally lamp illuminates and the recording indicator at the top of the screen changes from [STBY] to [●REC].
- The access indicator of cards used for recording will illuminate in red.
- You can also perform this function remotely using Browser Remote on a connected network device (📖 186).

4 Press the REC button to stop recording.

- The clip is recorded and the camera enters record standby mode. The tally lamp goes out.
- The access indicator of cards selected for recording will change back to green.

! IMPORTANT

- Be sure to save your recordings regularly, especially after making important recordings. Canon shall not be liable for any loss or corruption of data.

i NOTES

- If you record using metadata or News Metadata settings, those settings will be recorded with the clip. For more details, refer to *Using Metadata* (106).
- If the camera switches to the other card while recording video due to the relay recording function (35), the two parts (before/after the switch) will be recorded as separate clips.
- A single clip can be recorded continuously for up to 6 hours. At that point, a new clip will be created automatically and recording will continue on a separate clip.
- You can use the review function (49) to play back part or all of the last clip recorded without having to switch to MEDIA mode.
- When recording clips on SDHC cards, the video (stream) file in the clip will be split approximately every 4 GB. Playback with the camera will be seamless.
- You can assign the [REC] function to assignable button Camera 11 and use it to start/stop recording.
- You can set **MENU** > [System Setup] > [Onscreen REC/STBY Button] to [On] to use the onscreen [●REC]/[STBY] touch buttons to stop and start recording respectively.
- When **MENU** > [System Setup] > [Tally Lamp Settings] is set to an option other than [REC], the tally lamp illuminates when PGM tally information is input.

Recording in Full Auto Mode

Set the FULL AUTO switch to ON to set the camera to full auto mode. In full auto mode, the camera automatically sets the aperture, ISO/gain, shutter speed, and white balance. The camera will continuously adjust the brightness and white balance automatically*. The focus mode, however, will not be set to autofocus.

* The light metering mode (67) will be set to [Standard], AE shift (67) will be set to [±0] and the limit for auto mode if it is activated (62) will be set to [Off/ISO 12800] (when [ISO/Gain] is set to [ISO]) or [Off/21.0 dB] (when [ISO/Gain] is set to [Gain]). Also, [AE Response] operation will be [Normal] regardless of the setting (195).

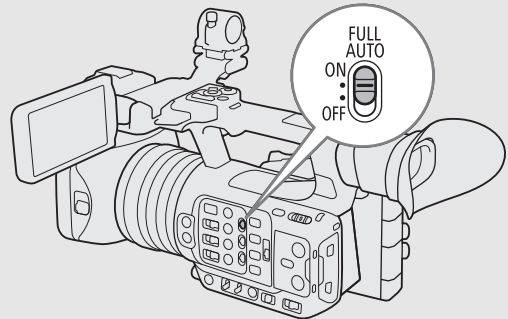
**To take photos**

While the camera is in record standby mode, you can record photos on SD card B.

- 1 Set an assignable button to [Photo] (119).
- 2 When the camera is in record standby mode, press the assignable button.
 - ▶ [B] appears on the screen and the photo is recorded on SD card B.
 - The SD CARD access indicator will illuminate in red.
 - The size of the recorded photos is 3840x2160.

i NOTES

- **Photos cannot be recorded in the following cases**
 - While recording a clip, or when slow & fast motion recording is activated.
 - When pre-recording is activated.
 - While using the camera as a web camera.
 - While Browser Remote is activated.
 - While color bars are displayed.

Onscreen Displays

Refer to this section for an explanation of the various screen displays that appear in CAMERA mode. You can use the custom display function (☰ 201) to turn off individual onscreen displays if they are not required. The menu item that controls each display is given in the following tables (1: indicates a menu item under [Custom Display 1] and 2: indicates a menu item under [Custom Display 2]).

The position of some icons and onscreen displays may change depending on the display level settings, which can be set to level 1, level 2 or level 3. The following screenshot and tables describe the onscreen displays at display level 1 with the [All Displays] setting (☰ 46).

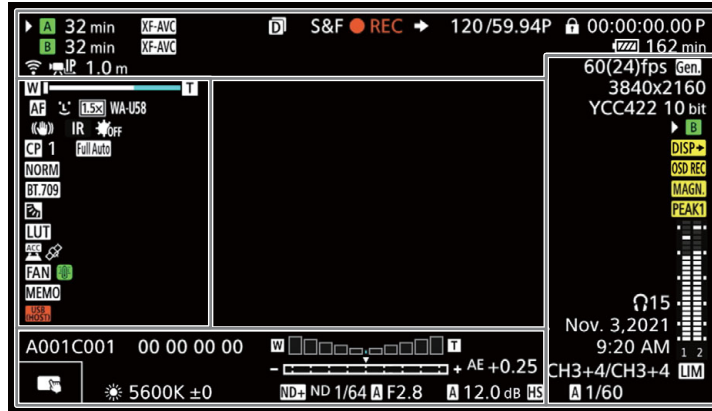

AF frames

You can turn AF frames on/off with the **MENU** > [☰ Monitoring Setup] > [Custom Display 1] > [Focus Mode] setting.



Left side of the screen

Icon/Display	Description	Custom Display
, Z 00/00	Zoom (📖 71).	1: [Zoom Indicator], [Zoom Position]
	Focus mode (📖 76).	1: [Focus Mode]
	Face AF (📖 81).	
	Digital tele-converter (📖 71)	1: [Tele-converter]
TL-U58, WA-U58	Conversion lens optimization (📖 75)	1: [Conversion Lens]
	Image stabilization (📖 84).	1: [Image Stabilizer]
	Infrared recording and infrared light (📖 114).	1: [IR Rec]
	Full automatic mode (📖 42)	1: [Full Auto]
	Custom picture file selected (📖 124).	1: [Custom Picture]
	[Gamma/Color Space] setting in the custom picture file (📖 128).	
	Look Files (📖 126).	
	Light metering mode (📖 67).	1: [Light Metering]
	A viewing LUT has been applied (📖 154).	1: [LUT]
	Multi-function shoe (📖 30).	2: [Multi-Function Shoe]
	GPS signal: continuously on - satellite signal acquired; flashing - satellite signal not acquired. • Displayed only when a GP-E2 GPS Receiver is connected to the camera.	2: [GPS]
	Fan operation: in white – normal (📖 40); in red – fan warning (📖 220).	2: [Temperature/Fan]
	Temperature warning (📖 40). • When the camera internal temperature rises above a certain level, will appear in yellow. If the temperature rises further, will appear in red.	
	User memo (📖 106).	2: [User Memo]
	USB (HOST) terminal status (📖 219).	2: [USB HOST]





Top of the screen

Icon/Display	Description	Custom Display
Recording media status, estimated remaining recording time and recording format		2: [Remaining Rec Time]
(in green) 000 min	: SD card (primary clips). The card's status is indicated by the icon's color: in green – can record; in yellow – card almost full (5 minutes or less); in red – card almost full (less than 1 minute); in white – reading the card. • The card selected for recording is indicated with a ▶ mark.	
(in red) END	Card is full.	
	No card or cannot record on the card.	
	Video format (📖 54).	
	Audio files for slow & fast motion recording (📖 109).	
	Network connection status (📖 180).	2: [Network Functions]
000.0 m	Object distance.	1: [Object Distance]







Icon/Display	Description	Custom Display
	Double slot recording (📖 35).	2: [Recording Mode]
Recording operation		
STBY, ● REC	Clip recording: record standby, recording.	
S&F STBY, S&F ● REC	Slow & fast motion recording (📖 109): record standby, recording.	
PRE STBY, PRE ● REC	Pre-recording (📖 111): record standby, recording.	
FRM STBY, FRM ● REC, FRM ● STBY	Frame recording (📖 111): record standby, recording.	
INT STBY, INT ● REC, INT ● WAIT	Interval recording (📖 112): record standby, recording.	
CONT, ● CONT	Continuous recording (📖 113)	
1s to 10m00s	Interval counter.	2: [Interval Counter]
REC ➡, STBY ➡, EXT REC ➡, EXT STBY ➡	Recording command (📖 151). "EXT" is displayed when there is no recording media.	2: [Rec Command (EXT REC)]
00.00P, 00.00i	Frame rate (📖 54). When slow & fast motion recording is activated, the shooting frame rate is also displayed (000/00.00P).	2: [Frame Rate]
	Key lock (📖 15).	1: [Key Lock]
00:00:00.00 / 00:00:00:00 R, P, F, E	Time code (📖 88). Time code status (📖 89).	2: [Time Code]
Power supply level indicator		
 000 min	Remaining battery charge of a BP-A30 or BP-A60 Battery Pack and estimated remaining usage time (in minutes). <ul style="list-style-type: none"> When is displayed, replace the battery pack with a fully charged one. Depending on the conditions of use, the actual battery charge level may not be indicated accurately or may not match the levels shown on the [🔧 System Setup] status screen or the indicators on the battery pack. 	2: [Remaining Battery]
DC IN 00.0V	Power supply voltage when using an AC adapter. <ul style="list-style-type: none"> When the voltage falls below the selected low-power warning level (📖 207), the voltage will be displayed in red. 	

Right side of the screen

Icon/Display	Description	Custom Display
60(24)fps, 60(30)fps	Video output (📖 122).	2: [Output Terminals Status]
Gen.	Genlock (📖 92).	2: [Genlock]
0000x0000	Resolution (📖 54).	2: [Resolution/ Color Sampling]
YCC000 00 bit	Color depth, color sampling (📖 54).	
▶ (in green)	Photo recorded on the SD card (📖 42).	2: [Photo]
▶ (in red)	No SD card or cannot record photos on the SD card.	
DISP▶ (in yellow)	Output onscreen displays (📖 151).	2: [OSD Output]
OSD REC (in yellow)	Record selected onscreen displays with primary clips (📖 199).	2: [OSD Recording]
MAGN (in yellow)	Magnification (📖 78).	1: [Magnification]
PEAK1 , PEAK2 (in yellow)	Peaking (📖 78).	1: [Peaking]

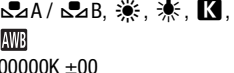
Icon/Display	Description	Custom Display
	Audio level meter (📖 98).	2: [Audio Level Indicator]
	Headphone volume (📖 140).	—
Date/time		2: [Date/Time]
CH0/CH0, CH0+CH0/CH0+CH0	Audio output channels (📖 159).	2: [Monitor Channels]
	Audio limiter (📖 99).	2: [Audio Level Indicator]
 1/0000.00, 000.00°, 000.00Hz	Shutter speed (📖 60).	1: [Shutter]

Bottom and center of the screen

Icon/Display	Description	Custom Display
A001C001 to Z999D999	Clip identification. Includes the camera index, reel number and clip number components of the clip file name (📖 37).	2: [Reel/Clip Number]
00 00 00 00	User bit (📖 90).	2: [User Bit]
	Zoom amount (📖 73). • Displayed when you operate the grip zoom while [Grip Zoom Speed] is set to [User Setting].	1: [Grip Zoom Speed: User]
	Direct touch control (📖 50)	—
 A / B, ☀, 🌙, K, AWB 00000K ±00	White balance (📖 68).	1: [White Balance]
	Exposure bar (📖 67).	1: [Exposure Bar]
AE ±0.00	AE shift (📖 67).	1: [AE Shift]
ND 1/00, ND+, ND-	ND filter/ND warning (📖 64).	1: [ND Filter]
 , F00.0 / closed	Aperture value (📖 65).	1: [Iris]
 ISO 000000, 00.0dB	ISO speed/Gain value (📖 62).	1: [ISO/Gain]
	Using the high sensitivity mode (📖 63).	

Selecting the Onscreen Display Level

You can press the DISP button to control the amount of information shown over the image (except when using onscreen displays in portrait mode). Repeatedly pressing the DISP button will change the display level: Display level 1 → Display level 2 → Display level 3 → Display level 1. In CAMERA mode, you can change the information displayed at each display level in the menu (📖 201).



Example of the
[Main Recording Displays] option

CAMERA mode

Display level ¹	Options	Description
[DISP Level 1]	[All Displays]	All onscreen displays at a larger size.
	[All Displays (Periph. Border)]	All onscreen displays at a smaller size, more appropriate for use with the peripheral border.
[DISP Level 2] ²	[Main Recording Displays]	Only the onscreen displays most relevant for shooting.
	[Only FUNC/MENU]	Only markers, focus frames, and video scopes are displayed. When the FUNC button, MENU button or an assignable button is pressed, the necessary information will be displayed.
[DISP Level 3] ²	[Only REC/STBY]	No onscreen displays except for the recording operation (REC/STBY).
	[No Displays]	No onscreen displays at all.

MEDIA mode

Display level ¹	During photo/clip playback	Index screen/During audio playback
[DISP Level 1]	All onscreen displays.	All onscreen displays.
[DISP Level 2]	No onscreen displays.	
[DISP Level 3]	–	

¹ **MENU** > [ⓘ] Monitoring Setup > [DISP Level 1], [DISP Level 2] or [DISP Level 3].

² Smaller onscreen displays (same size as when set to [All Displays (Periph. Border)]).

i NOTES

- The zebra pattern and false color display will appear on the screen regardless of the selected display level.
- You can change the transparency level of onscreen displays (📖 152).

Peripheral Border Display

You can apply the peripheral border display to all display levels. With the peripheral border display, the camera's image is reduced slightly so the onscreen displays are shown mostly around it and not on top of it, partially hiding it. The peripheral border is linked with the display level. You can select the levels that use the peripheral border with the **MENU** > [ⓘ] Monitoring Setup > [Apply Peripheral Border] setting.



Full-screen display



Peripheral border display

Displaying the Tally OSD

You can display tally information input via XC protocol on the screen (Tally OSD).

- 1 Select **MENU** > [ⓘ] Monitoring Setup > one of the [Tally OSD:] settings > [On].
 - Confirm and/or change the screen for tally OSD display and the output destination.
- 2 Select **MENU** > [ⓘ] Monitoring Setup > [Tally OSD Settings] > Desired option.

Tally OSD Settings List

[Tally OSD Settings]	Tally Input State	Recording Status (REC)	Tally OSD Lamp Color
[Tally In (PGM/PVW)]	PGM	—	Red
	PVW		Green
	PGM + PVW		Amber
[REC]	—	Recording	Red
[REC/Tally In (PGM/PVW)]	—		Record Standby Mode
	PGM	Green	
	PVW	Amber	

3 Select **MENU** > [Monitoring Setup] > [Tally OSD Position] > Desired option.



Frame



Top



Bottom

NOTES

- Recorded video/still images are not affected.

Onscreen Displays in Portrait Mode

When shooting in portrait mode, you can change the orientation of the onscreen displays.

Select **MENU** > [Monitoring Setup] > [OSD Orientation: LCD/VF] > [90 Degrees Right] or [90 Degrees Left].

NOTES

- Video output from the HDMI OUT jack/SDI OUT terminal can be changed by setting **MENU** > [Monitoring Setup] > [OSD Orientation: HDMI] or [OSD Orientation: SDI] (only when rotating the LCD monitor/viewfinder onscreen displays).
- The menu and status screens cannot be rotated.
- Direct touch control and the peripheral border display cannot be used when the CAMERA mode screen is rotated.
- When [OSD Recording] is enabled, you cannot rotate the CAMERA mode screen.



Reviewing a Recording

You can review all or part of the last clip recorded even with the camera set to CAMERA mode.

1 Select **MENU** > [🔧 System Setup] > [Review Recording] > Desired option.

2 After you finish recording a clip, press the  button.

- The last clip that was recorded is played back for the selected duration. [▶ REVIEW] appears on the screen.
- There will be no sound from the built-in speaker but the audio will be output from the  (headphone) terminal and HDMI OUT terminal.
- You can use the joystick to jump back/forward within the clip. You can also touch or slide the onscreen progress bar to move to a different position in the video ([139](#)).
- Press CANCEL or flick down on the screen to stop reviewing the clip.
- After the clip finishes playing back, or if you stop reviewing the clip, the camera returns to record standby mode.

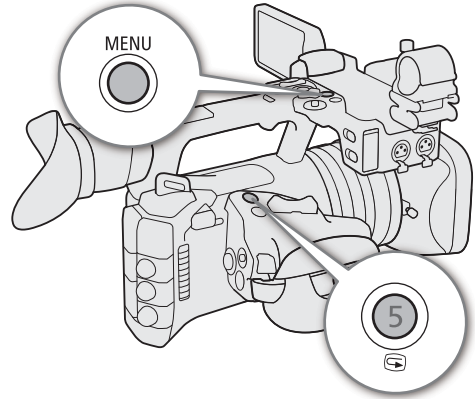

Options

[Entire Clip]: Allows you to review the entire clip.

[Last 4 sec]: Allows you to review just the last 4 seconds of the clip.

NOTES

- If the camera switched cards during a recording, the camera will play back the clip on the card most recently recorded on.
- You cannot review clips when continuous recording is activated.







Adjusting Camera and Recording Settings

Using direct touch control, you can perform a variety of settings (camera, recording, assistance functions, etc.) in CAMERA mode. White balance and exposure related settings can also be modified with the direct setting mode, using the FUNC button.

Performing Basic Settings with Direct Touch Control

With direct touch control you can change commonly used settings such as camera and recording settings and assistance functions. For details about each function, refer to the respective section on the manual.

Available Direct Touch Control Settings

Touch button	Available settings
White balance	White balance mode (preset, color temperature), color correction value.
ND filter	Off, 3 different density settings.
Aperture	Adjustment of the F value.
ISO/Gain	Adjustment of ISO or gain value.
Shutter speed	Adjustment of the value in the current shutter speed mode.
 (assistance functions)	Focus guide (on/off), peaking (type), WFM, zebra (type), false color (on/off), markers (on/off), view assistance (on/off).
 (recording settings)	Recording mode, second card recording functions, continuous recording ^{1, 2} , slow & fast shooting frame rate, frame recording, frame recording frame rate, interval recording, interval recording frame rate, interval recording time interval, chunk recording time setting, main recording format,  file selection, main resolution, frame rate, bit rate,  recording format, proxy recording color conversion,  recording resolution/bit rate and  recording frame rate.

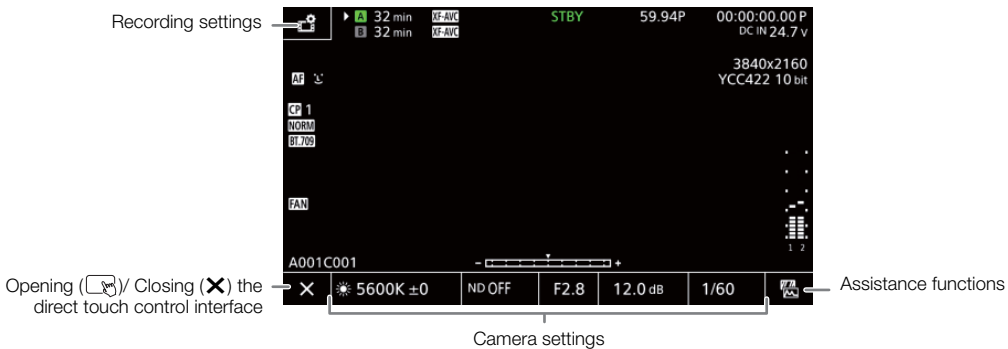

¹ Only when the main recording format is MP4.

² Only when the [Continuous Recording] setting ( 113) is changed from [STBY] to [REC].



Turn on/off the Direct Touch Control Interface

Even when the direct touch control interface is displayed, you can still use other functions such as recording, menu settings, direct setting mode or status screens.

- 1 Touch  to open the direct touch control interface.
- 2 Touch  to close the direct touch control interface.

Changing Camera Settings

- 1 Touch the setting you want to adjust, then select the desired value/setting.
 - Once the settings menu is displayed, touch to select the desired value/setting as needed.
 - When the slider appears, drag the slider left/right or touch the ◀/▶ buttons to adjust the desired value.
- 2 Touch ↶.



Drag the slider to select the desired value

Using Assistance Functions

- 1 Touch  (assistance functions) and then turn assistance functions on/off, or select the desired assistance function.
- 2 Touch ↶.

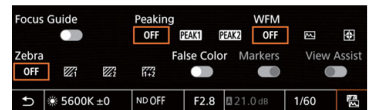

Changing Recording Settings

- 1 Touch  (Recording Settings)
 - The recording settings menu will be displayed. There are three pages that can be switched by swiping left and right.
- 2 Select the desired menu setting and then select the desired option.
- 3 Touch ✕.

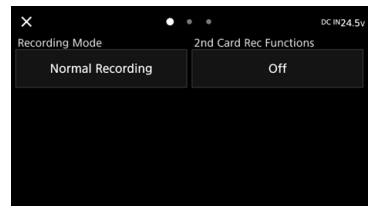

Direct Setting Mode (FUNC Button)

You can adjust main camera functions—white balance, aperture, ISO speed/gain and shutter speed—using the FUNC button (direct setting mode). This section will explain the basic operation of the direct setting mode. For details about each function, refer to the respective section on the manual.

- 1 Press the FUNC button.
 - The onscreen display of the selected function will be highlighted in orange.
 - Press the FUNC button repeatedly or push the joystick left/right to select a different function.
- 2 Push the joystick up/down to select the desired value or white balance mode.
- 3 Press SET.
 - The selected value/mode will be set and direct setting mode will end.
 - The onscreen display of the selected function will return to normal.

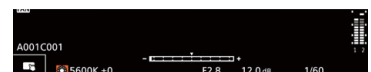
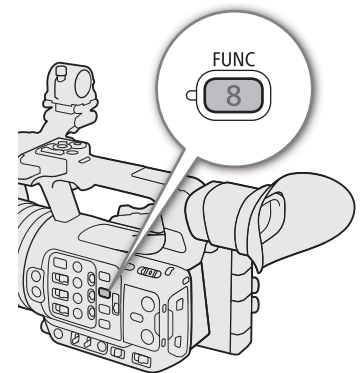

NOTES

- The camera will automatically end the direct setting mode in the following cases.
 - If no operation was performed for more than 6 seconds.
 - If the FUNC button is pressed while selecting the shutter speed.
 - If the menu or a status screen was opened.

- If you set an assignable button to [White Balance], [Iris], [ISO/Gain] or [Shutter] (☐ 119), you can press the button to enter direct setting mode with the respective function highlighted.

Video Recording Configuration: Video Format, System Frequency, Resolution and Frame Rate

When recording media, you can set the video configuration used for primary clips with the following procedures. Select the main recording format (video format, color sampling, bit depth), primary resolution, frame rate and bit rate settings that best match your creative needs. Available options for some settings may change depending on previous selections for other settings. See the following tables for a summary.

For details about sub recording clips and audio, refer to *Sub Recording Clips* (📖 58) and *Recording Audio* (📖 94) respectively.

XF-AVC

Main recording format	Main resolution	Bit rate method ¹	Bit rate	System frequency/Frame rate						
				59.94 Hz				50.00 Hz		
				59.94P	59.94i	29.97P	23.98P	50.00P	50.00i	25.00P
XF-AVC YCC422 10 bit	3840x2160	Intra-frame	600Mbps	●	–	–	–	–	–	–
			500Mbps	–	–	–	–	●	–	–
			410Mbps	–	–	●	●	–	–	●
			300Mbps	–	–	●	–	–	–	–
			250Mbps	–	–	–	–	–	–	●
			240Mbps	–	–	–	●	–	–	–
	Long GOP	260Mbps	●	–	–	–	●	–	–	
		160Mbps	–	–	●	●	–	–	●	
	1920x1080	Intra-frame	310Mbps	●	–	–	–	●	–	–
			160Mbps	–	●	●	●	–	●	●
		Long GOP	50Mbps	●	●	●	●	●	●	●
			25Mbps	–	● ²	–	–	–	● ²	–
1280x720	Long GOP	24Mbps	●	–	–	–	●	–	–	

¹ The camera uses a variable bit rate (VBR). Intra-frame options compress the image after analyzing each frame separately and are more appropriate for editing. Long GOP options compress the image after analyzing also changes across a group of pictures and offer better compression (smaller data size).

² Cannot be selected when one of the following second card recording functions is enabled: sub recording, audio recording, relay recording or double slot recording.

MP4

Main recording format	Main resolution	System frequency/Frame rate				
		59.94 Hz			50.00 Hz	
		59.94P	29.97P	23.98P	50.00P	25.00P
MP4(HEVC) YCC422 10 bit	3840x2160	●	●	●	●	●
MP4(HEVC) YCC420 10 bit	1920x1080	●	●	●	●	●
MP4(H.264) YCC420 8 bit	1280x720	●	–	–	●	–

NOTES

- For details on the signal output from each terminal, refer to *Video Output Configuration* (📖 145).

Selecting the System Frequency

You can change the system frequency also in MEDIA mode if you want to play back clips from a card recorded with a different system frequency setting.

- 1 Select **MENU** > [Recording/Media Setup] > [System Frequency].
- 2 Select the desired option.
 - The camera will reset and restart in the selected mode.

Selecting the Main Recording Format

Select the combination of video format, color sampling and bit depth for primary clips.

- 1 Select **MENU** > [Recording/Media Setup] > [Main Rec Format].
 - You can also adjust this setting using direct touch control (50).
- 2 Select the desired option.

Selecting the Resolution for Primary Clips

- 1 Select **MENU** > [Recording/Media Setup] > [Main Resolution].
 - You can also adjust this setting using direct touch control (50).
- 2 Select the desired option.

Selecting the Frame rate for Primary Clips

- 1 Select **MENU** > [Recording/Media Setup] > [Frame Rate].
 - You can also adjust this setting using direct touch control (50).
- 2 Select the desired option.

Selecting the Bit Rate for Primary Clips

Select the bit rate when the primary clip has the following recording format, resolution and frame rates.

Main recording format	Main resolution	Frame rate	Bit rate
XF-AVC YCC422 10 bit	3840x2160 Intra-frame	29.97P	410Mbps, 300Mbps
		25.00P	410Mbps, 250Mbps
		23.98P	410Mbps, 240Mbps
	1920x1080 Long GOP	59.94i, 50.00i	50Mbps, 25Mbps

- 1 Select **MENU** > [Recording/Media Setup] > [Bit Rate].
 - Operation by direct touch control is also possible (50).
- 2 Select the desired option.

Proxy Clips

While recording a primary clip on SD card A, you can simultaneously record the same scene as a proxy clip on SD card B. Because proxy clips have smaller files, they are suitable for offline editing.

You can also use direct touch control to perform this function (📖 50).

Additionally, you can use Content Transfer Mobile to automatically transfer proxy clips to an FTP server (📖 161).

Video configuration of proxy clips

Primary clip			Video configuration of proxy clips		
Main recording format	Main resolution	Frame rate	Recording format and resolution / bit rate		Frame rate
			XF-AVC YCC420 8 bit	MP4 (H.264) YCC420 8 bit	
XF-AVC YCC422 10 bit	3840x2160, 1920x1080	59.94P, 50.00P	1920x1080 / 35Mbps Long GOP	1920x1080 / 9Mbps, 1280x720 / 9Mbps, 1280x720 / 6Mbps, 1280x720 / 4Mbps	Same as main clip ³
		29.97P, 25.00P, 23.98P	1920x1080 / 24Mbps Long GOP ¹		
	1920x1080	59.94i, 50.00i		1920x1080 / 16Mbps ²	
MP4 (H.264) YCC420 8 bit	3840x2160, 1920x1080	59.94P, 50.00P	–	1920x1080 / 9Mbps, 1280x720 / 9Mbps, 1280x720 / 6Mbps, 1280x720 / 4Mbps	Same as main clip
		29.97P, 25.00P, 23.98P	–		
	1280x720	59.94P, 50.00P	1280x720 / 17Mbps Long GOP	1280x720 / 9Mbps, 1280x720 / 6Mbps, 1280x720 / 4Mbps	
	1280x720	59.94P, 50.00P	–	1280x720 / 6Mbps, 1280x720 / 4Mbps	

¹ Only when an option other than [25 Mbps] is selected for [Bit Rate] of the main clip.

² Only when [25 Mbps] is selected for [Bit Rate] of the main clip.

³ When [MP4(H.264) YCC420 8 bit] is selected for [B]Rec Format] and [1920x1080 16Mbps] is selected for [B]Resolution/Bit Rate], recording is performed in progressive format.

- 1 Insert an SD card into each card slot (slot A for the main clip, slot B for the proxy clip).
- 2 Set the main recording format to XF-AVC or MP4 (H.264) (📖 54).
- 3 Select **MENU** > [🔧 Recording/Media Setup] > [2nd Card Rec Functions] > [A]Main / [B]Proxy Rec].
- 4 Select **MENU** > [🔧 Recording/Media Setup] > [B]Rec Format] > Desired option.
 - Only available when the main recording format is set to XF-AVC.
- 5 Select **MENU** > [🔧 Recording/Media Setup] > [B]Resolution/Bit rate] > Desired option
 - Availability depends on the combined settings for the main recording or the proxy recording.
- 6 Select **MENU** > [🔧 Recording/Media Setup] > [Proxy Rec Color Conversion] > Desired option.
- 7 Press the REC button to start recording.
 - Proxy clips will be recorded simultaneously with the primary clips.

Options

[Conform to Custom Picture]:

No change is applied.

[BT.709 (Wide DR)] / [BT.709 (CMT 709)]:

When the gamma curve component of the [Gamma/Color Space] setting in the custom picture file is set to one of the [BT.709] / [Canon 709] options or when the gamma curve (after applying a Look File) is one of the [SDR] options, no change is applied. When it is set to a different option, it is changed to the selected gamma curve and the color space component changes to [BT.709]. If the original gamma was set to HDR, you can adjust the brightness settings with the **MENU** > [🔧 Monitoring Setup] > [Gain for HDR→SDR Conv.] setting (📖 158).

 NOTES

- If the recording of the primary clip stops during simultaneous recording, recording of the proxy clip will stop as well.
- If there is no card inserted in the slot used for the primary clip, only the proxy clip will be recorded.

Chunk Recording Clips for Automatic Transfer

While recording a primary clip on SD card A, you can simultaneously record clips divided in chunks (according to the specified time setting) on SD card B. Enable the automatic transfer function from Content Transfer Mobile to transfer the recorded clips sequentially (📖 161). Chunk recording clips can be transferred even while the main clip is being recorded, reducing the wait time of the receiver. You can also use direct touch control (📖 50) to perform this setting.

Video configuration of chunk recording clips

Primary clip				Video configuration of chunk recording clips			
Main recording format	Main resolution	Frame rate	Bit rate	Recording format	Resolution	Frame rate	Bit rate
XF-AVC YCC422 10 bit	1920x1080 Long GOP	59.94i	25Mbps	MP4 (H.264) YCC420 8 bit	1920x1080 Long GOP	59.94P	16Mbps
		50.00i				50.00P	

- 1 Insert an SDXC card into each card slot (slot A for the main clip, slot B for chunk clip recording).
- 2 Set the video configuration for the main clip (📖 54).
- 3 Select **MENU** > [📷 Recording/Media Setup] > [2nd Card Rec Functions] > [[A] Main / [B] Chunk Rec].
- 4 Select **MENU** > [📷 Recording/Media Setup] > [Chunk Rec: Time Setting] > the desired option (📖 198).
- 5 Press the REC button to start recording.
 - Recording of the main clip and chunk recording start simultaneously.

NOTES

- If the recording of the primary clip stops during simultaneous recording, chunk recording will stop as well.
- If there is no card inserted in the slot used for the primary clip, only chunk recording is performed.
- The chunk recording time interval may differ slightly from the selected time setting by up to 1.5 seconds.

Sub Recording Clips

While recording a primary clip on SD card A, you can simultaneously record the same scene on SD card B. See the following table for more details on the video configuration for sub recording clips. For more details on audio, see *Recording Audio* (📖 94).

You can also use direct touch control to perform this function (📖 50).

Video configuration for sub recording clips (primary clip: XF-AVC)

Primary clip				Video configuration of sub recording clips ¹		
Main recording format	Main resolution	Frame rate	Bit rate	Sub recording format, resolution and bit rate		
				XF-AVC YCC422 10 bit	MP4 (H.264) YCC420 8 bit	
XF-AVC YCC422 10 bit	3840x2160	Intra-frame	59.94P, 50.00P	600Mbps 500Mbps	1920x1080 / 310Mbps Intra-frame 1920x1080 / 160Mbps Intra-frame ² 1920x1080 / 50Mbps Long GOP ³ 1280x720 / 24Mbps Long GOP	1920x1080 / 35Mbps 1280x720 / 8Mbps
			29.97P	410Mbps	3840x2160 / 300Mbps Intra-frame 3840x2160 / 160Mbps Long GOP 1920x1080 / 160Mbps Intra-frame 1920x1080 / 50Mbps Long GOP	3840x2160 / 150Mbps 1920x1080 / 35Mbps
			25.00P		3840x2160 / 250Mbps Intra-frame 3840x2160 / 160Mbps Long GOP 1920x1080 / 160Mbps Intra-frame 1920x1080 / 50Mbps Long GOP	
			23.98P		3840x2160 / 240Mbps Intra-frame 3840x2160 / 160Mbps Long GOP 1920x1080 / 160Mbps Intra-frame 1920x1080 / 50Mbps Long GOP	
		29.97P, 25.00P 23.98P	300Mbps 250Mbps 240Mbps	3840x2160 / 160Mbps Long GOP 1920x1080 / 160Mbps Intra-frame 1920x1080 / 50Mbps Long GOP		
		Long GOP	59.94P, 50.00P	260Mbps	1920x1080 / 50Mbps Long GOP ³ 1280x720 / 24Mbps Long GOP	1920x1080 / 35Mbps 1280x720 / 8Mbps
	29.97P, 25.00P, 23.98P		160Mbps	1920x1080 / 50Mbps Long GOP	3840x2160 / 150Mbps, 1920x1080 / 35Mbps	
	1920x1080	Intra-frame	59.94P, 50.00P	310Mbps	1920x1080 / 50Mbps Long GOP, 1280x720 / 24Mbps Long GOP	1920x1080 / 35Mbps, 1280x720 / 8Mbps
			29.97P, 25.00P, 23.98P	160Mbps	1920x1080 / 50Mbps Long GOP	1920x1080 / 35Mbps
			59.94i, 50.00i			–
		Long GOP	59.94P, 50.00P	50Mbps	1280x720 / 24Mbps Long GOP	1920x1080 / 35Mbps, 1280x720 / 8Mbps
			29.97P, 25.00P, 23.98P		–	1920x1080 / 35Mbps
	1280x720	Long GOP	59.94P, 50.00P	24Mbps	–	1280x720 / 8Mbps

¹ Sub recording frame rate is the same as that of the primary clip.

² Only 59.94i/50.00i can be selected.





³ 59.94i/50.00i can also be selected.

Video configuration for sub recording clips (primary clip: MP4)

Primary clip				Video configuration of sub recording clips ¹		
Main recording format	Main resolution	Frame rate	Bit rate	Sub recording format, resolution and bit rate		
				MP4 (HEVC) YCC422 10 bit	MP4 (HEVC) YCC420 10 bit	MP4 (H.264) YCC420 8 bit
MP4 (HEVC) YCC422 10 bit	3840x2160	59.94P, 50.00P	225Mbps	1920x1080 / 50Mbps, 1280x720 / 12Mbps	1920x1080 / 35Mbps, 1280x720 / 9Mbps	-
		29.97P, 25.00P, 23.98P	135Mbps	1920x1080 / 50Mbps	3840x2160 / 100Mbps, 1920x1080 / 35Mbps	
	1920x1080	59.94P, 50.00P	50Mbps	1280x720 / 12Mbps	1280x720 / 9Mbps	
		29.97P, 25.00P, 23.98P		-	1920x1080 / 35Mbps	
1280x720	59.94P, 50.00P	12Mbps	-	1280x720 / 9Mbps		
MP4 (HEVC) YCC420 10 bit	3840x2160	59.94P, 50.00P	170Mbps	-	1920x1080 / 35Mbps, 1280x720 / 9Mbps	-
		29.97P, 25.00P, 23.98P	100Mbps		1920x1080 / 35Mbps	
	1920x1080	59.94P, 50.00P	35Mbps		1280x720 / 9Mbps	
MP4 (H.264) YCC420 8 bit	3840x2160	59.94P, 50.00P, 29.97P, 25.00P, 23.98P	150Mbps	-	-	1920x1080 / 35Mbps, 1280x720 / 8Mbps ²
	1920x1080	59.94P, 50.00P	35Mbps			1280x720 / 8Mbps

¹ Sub recording frame rate is the same as that of the primary clip.

² Only available when the frame rate is 59.94P/50.00P

- 1 Insert an SD card into each card slot (slot A for the main clip, slot B for the sub recording clip).
- 2 Select **MENU** > [ Recording/Media Setup] > [2nd Card Rec Functions] > [**A** Main / **B** Sub Rec].
- 3 Select **MENU** > [ Recording/Media Setup] > [**B** Rec Format] > Desired option.
- 4 Select **MENU** > [ Recording/Media Setup] > [**B** Resolution/Bit Rate] > Desired option.
- 5 Select **MENU** > [ Recording/Media Setup] > [**B** Frame Rate] > Desired option.
 - Frame rate can only be selected with some main recording formats.
- 6 Press the REC button to start recording.
 - Proxy clips will be recorded simultaneously with the primary clips.

NOTES

- If there is no card inserted in the slot used for the primary clip, only the sub recording clip will be recorded.

Shutter Speed

You can set the shutter speed according to the shooting conditions. For example, you may want to set slower shutter speeds in darker environments. The camera offers the following modes.

You can also perform this function remotely using Browser Remote on a connected network device (📖 188).

[Speed]: Allows you to set the shutter speed (in fractions of a second). You can select the increment to use when adjusting the shutter speed between 1/3-stop and 1/4-stop increments.

[Angle]: You can set the shutter angle to determine the shutter speed.

[Clear Scan]: Set the frequency in order to record CRT computer monitors without displaying black bands or flicker on the screen.

[Slow]: You can set slower shutter speeds to obtain brighter recordings in places with insufficient lighting. This mode is not available when slow & fast motion recording is activated.

[Auto]: The camera automatically adjusts the shutter speed based on the picture's brightness.

[Off]: The camera uses a standard shutter speed based on the frame rate.

Changing the Shutter Speed Mode

Set the SHUTTER switch to ON and then slide the switch toward SEL to change the shutter speed mode.

- Repeatedly pushing the switch toward SEL will change the shutter speed mode in the following order: Speed → Angle → Clear scan → Slow → Automatic.
- When set to Automatic, **A** will appear to the left of the shutter speed value on the screen. The displayed shutter speed value will change according to the automatic adjustment.

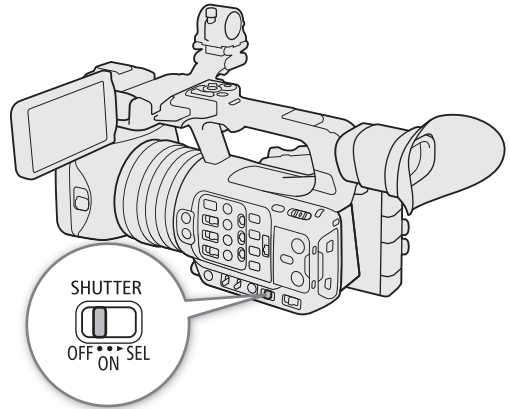

Available shutter speeds

The individual setting options that can be selected will change depending on the frame rate used.

Shutter speed mode		System frequency/Frame rate				
		59.94 Hz		50.00 Hz		
		59.94P / 59.94i ¹	29.97P	23.98P	50.00P / 50.00i ¹	25.00P
[Speed] ²	1/3-stop increments	1/1 to 1/2000 (34 setting options in total)				
	1/4-stop increments	1/1 to 1/2000 (59.94 Hz: 47 setting options in total, 50.00 Hz: 45 setting options in total)				
[Angle] ²		360.00°, 240.00°, 180.00°, 120.00°, 90.00°, 60.00°, 45.00°, 30.00°, 22.50°, 15.00°, 11.25° Also angle values equivalent to the following shutter speeds: 1/120, 1/100, 1/60, 1/50, 1/40, 3/100, 1/30, 1/25.				
[Clear Scan] ²		23.98 Hz to 1998 Hz			25.00 Hz to 2003 Hz	
[Slow] ³		1/4, 1/8, 1/15, 1/30	1/4, 1/8, 1/15	1/3, 1/6, 1/12	1/3, 1/6, 1/12, 1/25	1/3, 1/6, 1/12
[Off] ²		1/60	1/30	1/24	1/50	1/25

¹ Only when **MENU** > [📷 Recording/Media Setup] > [Main Rec Format] is set to [XF-AVC YCC422 10 bit] and [Main Resolution] is set to [1920x1080 Intra-frame] or [1920x1080 Long GOP].

² Available values depend on the frame rate, the slow & fast motion recording frame rate or the [Run VF at x2 Speed] setting. If [Run VF at x2 Speed] is set to [On], the shutter speed lower limit will be equivalent to 1/x seconds ("x" representing twice the value of the set frame rate).

³ Not available when slow & fast motion recording is activated, or when [Run VF at x2 speed] is set to [On].

Changing the Shutter Speed Value

When the shutter speed mode is set to a mode other than OFF or automatic, you can set the shutter speed manually.

- 1 Select the shutter speed mode (☞ 60).
- 2 For [Speed] only: Select **MENU** > [📷 Camera Setup] > [Shutter Increment] > [1/3 stop] or [1/4 stop].
- 3 Adjust the shutter speed, angle value or clear scan frequency using the direct setting mode (☞ 51).
 - You can also use direct touch control (☞ 50).

Using slow shutter mode

When recording in dark surroundings, you can obtain a brighter picture by using slow shutter mode. You can also use this mode when you wish to add certain effects to your recordings, such as blurring the background during panning shots or recording a moving subject with an afterimage trail.

- Image quality may not be as good as when using faster shutter speeds in brighter surroundings.

NOTES

- Closing down the aperture when recording under bright conditions may cause the picture to appear soft or out of focus. The following measures may be effective in avoiding the loss of sharpness due to diffraction.
 - Using a denser ND filter (☞ 64).
 - Using a faster shutter speed.
- When the camera is set to full auto mode (☞ 42) or you activate infrared recording (☞ 114), the shutter speed mode will be set to automatic. If you activate infrared recording, the upper limit for the shutter speed will be 1/250 (when **MENU** > [📷 Camera Setup] > [High Sensitivity Mode] is set to [Off]) or 1/500 (when set to [On]).
- When the shutter speed mode is set to [Slow], bright red, green or blue dots may appear on the screen. In such case, use a faster shutter speed or select a lower ISO speed or gain value (☞ 62).
- When an RC-V100 Remote Controller is connected to the camera, you can change the shutter speed mode with the remote controller's SHUTTER SELECT button and the shutter speed value with the remote controller's SHUTTER ▲/▼ buttons.

Flicker Reduction

You can perform the following procedure to have the camera automatically detect and reduce flicker.

Select **MENU** > [📷 Camera Setup] > [Flicker Reduction] > [Automatic].

NOTES

- When recording under artificial light sources such as fluorescent, mercury or halogen lamps, the screen may flicker depending on the shutter speed. You may be able to avoid flicker by setting the shutter speed mode to [Speed] and the shutter speed to a value matching the frequency of the local electrical system: 1/50* or 1/100 for 50 Hz systems, 1/60 or 1/120 for 60 Hz systems.
 - * May not be available depending on the frame rate.
- When the frame rate is 23.98P and **MENU** > [📷 Monitoring Setup] > [Run VF at x2 Speed] is set to [On], [Flicker Reduction] cannot be used.

ISO Speed/Gain

You may want to adjust the brightness of the image according to the shooting conditions. You can choose between manual and automatic settings. The camera offers 3 gain levels (L/M/H) that you can select simply by changing the position of the ISO/GAIN switch. By choosing automatic settings you can also set the maximum sensitivity value. By choosing manual settings you can change the ISO speed or gain value to adjust the sensitivity of the sensor.

You can also perform this function remotely using Browser Remote on a connected network device (📖 184, 188).

Available ISO speed and gain settings

Main recording format ¹	ISO/Gain ²	Increment	Normal range ³
XF-AVC MP4	[ISO]	[1 stop]	200, 400, 800, 1600, 3200, 6400, 12800
		[1/3 stop]	200, 250, 320, 400, 500, 640, 800, 1000, 1250, 1600, 2000, 2500, 3200, 4000, 5000, 6400, 8000, 10000, 12800
	[Gain]	[Normal] (3 dB)	-6.0 dB to 21.0 dB, 36.0 dB ⁴
		[Fine] (0.5 dB)	

¹ **MENU** > [📷 Recording/Media Setup] > [Main Rec Format] setting.

² **MENU** > [📷 Camera Setup] > [ISO/Gain] setting.

³ Available values will depend on the gamma curve component of the [Gamma/Color space] setting in the custom picture file. [Wide DR], [Canon Log 3] or [Canon 709]: ISO 500 to ISO 12800 (-2.0 dB to 21.0 dB). [PQ] or [HLG]: ISO 320 to ISO 12800 (-6.0 dB to 21.0 dB).

[BT.709 Normal] or [BT.709 Standard]: ISO 200 to ISO 12800 (-6.0 dB to 21.0 dB).

⁴ Only when using the [Gain Boost] setting (📖 121).

Automatic ISO Speed/Gain

The sensitivity is automatically adjusted according to the subject. You can also set a sensitivity limit.

Set the AGC switch to ON.

- The camera will adjust the gain automatically to obtain an appropriate exposure.
- The gain value set automatically by the camera will appear at the bottom of the screen with an **A** icon next to it.
- The sensitivity limit is ISO 500 (-2.0 dB) when the [Gamma/Color Space] setting in the custom picture file is set to [Wide DR], [Canon Log 3] or [Canon 709], ISO 320 (-6.0 dB) when set to [PQ] or [HLG], and ISO 200 (-6.0 dB) when set to [BT.709 Normal] or [BT.709 Standard]

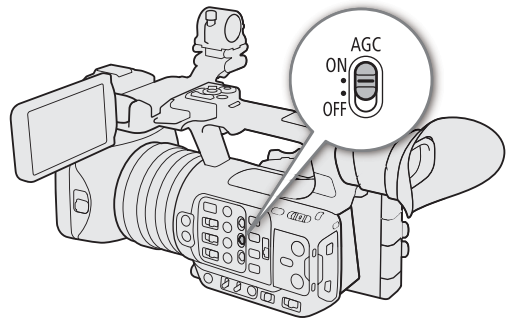

Setting an automatic ISO limit

By setting an ISO limit in automatic mode, you can curb the amount of noise and keep a dark ambient. When the camera is set to full auto mode (📖 42) or infrared recording is activated (📖 114), the limit will be set to [Off/ISO 12800] (when **MENU** > [📷 Camera Setup] > [ISO/Gain] is set to [ISO]) or [Off/21.0 dB] (when set to [Gain]).

Select **MENU** > [📷 Camera Setup] > [Limit for Auto Mode] > Desired option.

Manual ISO Speed/Gain Value

You can set beforehand 3 gain levels and then select quickly which one to apply simply by changing the position of the ISO/GAIN switch.

- 1 Set the AGC switch to OFF.
- 2 Set the ISO/GAIN switch to the position you want to adjust (L, M or H).

Setting the ISO Speed/Gain Value for the ISO/GAIN Switch

- 1 Select **MENU** > [Camera Setup] > [ISO/Gain] > [ISO] or [Gain].
- 2 Depending on your previous selection, select **MENU** > [Camera Setup] > [ISO/Gain Increment] > Desired option.
- 3 Select [Camera Setup] > Desired [ISO/Gain] setting.

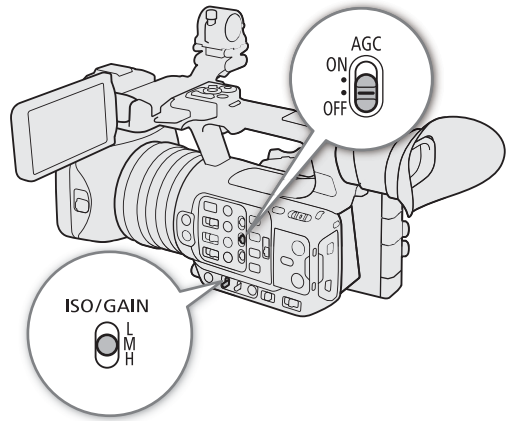

Changing the ISO/GAIN Value

- 1 Set the ISO/GAIN switch to the position you want to adjust (L, M or H).
- 2 Adjust the ISO speed or gain value using the direct setting mode (51).
 - You can also use direct touch control (50).

Using the High Sensitivity Mode

Using the high sensitivity mode allows for brighter recordings, useful when recording in dark environments.

- 1 Select **MENU** > [Camera Setup] > [ISO/Gain] > [Gain].
- 2 Select **MENU** > [Camera Setup] > [High Sensitivity Mode] > [On].
 - [HS] will appear to the left of the gain value on the screen.

i NOTES

- If you set an assignable button to [Gain Boost] (121), you can press the button to switch between a gain value of 36.0 dB and the currently set gain value.
- The [Gain Boost] setting (121) can be used when **MENU** > [Camera Setup] > [ISO/Gain] is set to [Gain] and automatic gain control is disabled.
- If [ISO/Gain] is set to [ISO], high sensitivity mode will end.
- When high ISO speeds or gain levels are set, the picture may flicker slightly.
- When high ISO speeds or gain levels are set, bright red, green or blue dots may appear on the screen. In such case, use a faster shutter speed (60) or select a lower ISO speed or gain value.
- When the ISO speed or gain level is changed, some noise may appear momentarily on the screen. Do not adjust the ISO speed/gain level while recording.
- When infrared recording is activated (114), the ISO speed/gain mode will be set to automatic gain control.
- You can use the **MENU** > [Camera Setup] > [Shockless Gain] setting to make the change in the image look smoother when you switch gain settings.
- When an RC-V100 Remote Controller is connected to the camera, you can adjust the gain value corresponding to the current position of the ISO/GAIN switch (L, M or H) with the remote controller's ISO/GAIN ▲/▼ buttons.

ND Filter

Using the ND filter allows you to open up the aperture to obtain a shallower depth of field even when recording in bright surroundings. You can also use the ND filter to avoid the soft focus caused by diffraction when using small apertures. You can select one of 3 density levels.

You can also perform this function remotely using Browser Remote on a connected network device (📖 188).

Press the ND FILTER + or – button to select the desired ND filter setting.

- Repeatedly pressing ND FILTER + button will change the ND filter setting in the following order: 1/4 → 1/16 → 1/64 → ND filter off. (The ND FILTER – button cycles through the settings in reverse order.)
- You can also adjust this setting using direct touch control (📖 50).

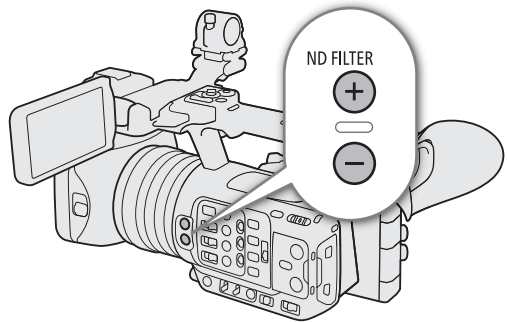

i NOTES

• About the ND warning:

In the following cases, if the ND filter setting is not appropriate, an ND warning icon will start flashing next to the ND filter setting*.

- The gain value is too high
- The aperture is too closed
- The shutter speed is too fast

Change the ND filter setting by pressing the ND + button (when **ND+** is flashing) or ND – button (when **ND-** is flashing) until the ND warning icon disappears to mitigate the effect of such conditions.

* When the RC-V100 Remote Controller is connected to the camera, the RC-V100's ND filter indicator will flash as well.

- Depending on the scene, the color may change slightly when turning the ND filter on/off. Setting a custom white balance (📖 70) may be effective in such case.

Changing the ND filter setting using the RC-V100 Remote Controller

- When the remote controller is connected to the camera, you can use the remote controller's ND button in the same way as the camera's ND FILTER + button.
- For the following settings: 1/4, 1/16 and 1/64, the corresponding ND filter indicator (1 to 3) will illuminate.

Aperture

You can affect the brightness of your recordings or change the depth of field by adjusting the aperture. You can also perform this function remotely using Browser Remote on a connected network device (📖 188).

Automatic aperture: The camera adjusts the aperture automatically.

Push Auto Iris: Momentary automatic aperture. During manual aperture, press the PUSH AUTO IRIS button or other control to temporarily adjust the aperture automatically.

Manual aperture: Adjust the aperture value manually.

Automatic Aperture

Set the IRIS switch to A.

- The camera will automatically adjust the aperture to obtain optimal exposure. The selected aperture value (F value) will appear at the bottom of the screen with an **A** icon next to it.

i NOTES

- You can use the **MENU** > [**Camera Setup**] > [AE Response] setting to change how quickly the aperture changes during automatic aperture mode.
- When the camera is set to full auto mode, the aperture will be adjusted automatically. When infrared recording is activated, it will be maintained open at the maximum aperture.

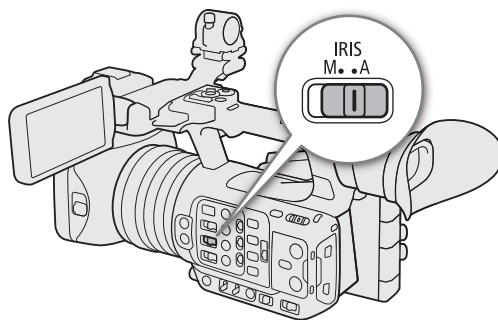

Momentary Automatic Aperture - Push Auto Iris

During manual aperture, you can press the PUSH AUTO IRIS button to have the camera temporarily take control and adjust the aperture automatically for an optimal exposure.

1 Set the IRIS switch to M.

2 Press and hold the PUSH AUTO IRIS button.

- The camera will automatically adjust the aperture to obtain optimal exposure as long as you hold the button pressed down, and **A** will appear on the screen next to the aperture value.
- When you release the button the aperture value will be set, automatic aperture mode will end and the **A** icon will disappear.

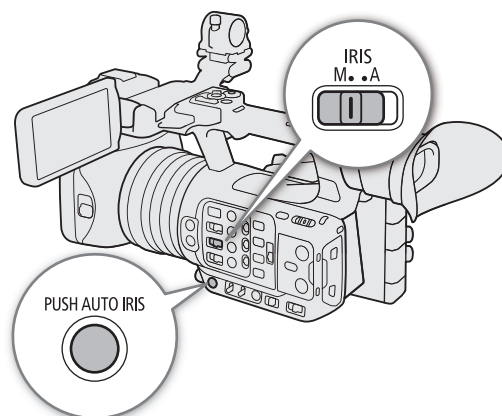

Manual Aperture: Changing the Aperture Value

1 Set the IRIS switch to M.

2 Select **MENU** > [**☰** Camera Setup] > [Iris Increment] > [1/3 Stop] or [1/4 Stop].

- You can also set **MENU** > [**☰** Camera Setup] > [Fine Increment] to [On] to use the smallest iris increment. Nevertheless, the aperture value displayed on the screen will be the closest value in the selected increment scale.

3 Turn the iris ring to adjust the aperture.

- You can also use direct setting mode (📖 51) or direct touch control (📖 50) to adjust the aperture value.

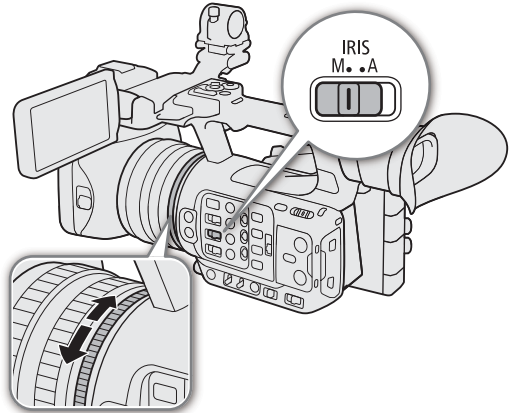

i NOTES

- The aperture value set manually will not be saved when you switch to automatic aperture (with the exception of full auto mode). Instead, the aperture value set automatically by the camera will be used when you switch back to manual aperture control.
- If the ND filter is activated, the picture may become dark when you set a high aperture value. In such case, press the ND FILTER – button and readjust the aperture.
- If you set an assignable button to [Iris +] or [Iris –] (📖 119), you can press the button to respectively open up or close down the aperture.
- You can use the **MENU** > [**☰** Camera Setup] > [Iris Ring Direction] setting to change the direction of the adjustment when you turn the iris ring.
- You can operate the iris ring even the camera's controls are locked (📖 15).
- When an RC-V100 Remote Controller is connected to the camera, you can adjust the aperture with the remote controller's IRIS dial. At default settings, turn the dial right to open up the aperture and left to close the aperture.
- You can also switch between automatic and manual aperture with the remote controller's AUTO IRIS button.

Iris Limit

You can set an iris limit to prevent the aperture from closing below the diffraction limit of the lens (F11).

Select **MENU** > [**☰** Camera Setup] > [Iris Limit] > [On].

- The maximum aperture value is [F11], the diffraction limit of the lens.
- If [Iris Limit] is set to [Off], you can fully close the aperture ([closed]). Aperture values that exceed the diffraction limit will appear in gray.

i NOTES

- Using aperture values that exceed the lens's diffraction limit may affect the recorded image (for example, causing diffraction blur). Using aperture values within the lens's diffraction limit (iris limit) is recommended.

Exposure Compensation - AE Shift

Use AE shift to compensate the exposure that was set using automatic aperture, in order to darken or lighten the image.

You can also perform this function remotely using Browser Remote on a connected network device (📖 188).

1 Select **MENU** > [**📷** Camera Setup] > [AE Shift].

2 Select the desired option.

- The camera will attempt to adjust the exposure accordingly.
- You can select one of 17 AE shift levels from -2.0 to +2.0.

i NOTES

- If you set an assignable button to [AE Shift +] or [AE Shift -] (📖 119), you can press the button to adjust the AE shift level.

The exposure bar

The ▼ on top of the exposure bar indicates optimal exposure without any shift (AE±0); the scale markings indicate the deviation from optimal exposure in 1/2 EV increments. The indicator inside the exposure bar represents the current exposure. When the difference between current and optimal exposure is larger than ±2 EV, the indicator will flash at the edge of the exposure bar. Optimal exposure will change depending on the light metering mode used.

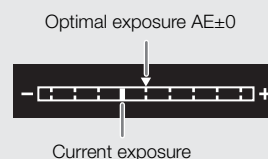

Light Metering Mode

Select the light metering mode to match the recording conditions. Using the appropriate setting will help achieve a more appropriate exposure level.

1 Select **MENU** > [**📷** Camera Setup] > [Light Metering].

2 Select the desired option.

- The icon of the selected mode (📷 or 👤) appears on the screen.

Options

[Backlight]: Suitable when recording backlit scenes.

[Standard]: Averages the light metered from the entire screen, giving more weight to the subject in the center.

[Spotlight]: Use this option when recording a scene in which only a certain part of the picture is lit, for example, when the subject is lit by a spotlight.

i NOTES

- If you set an assignable button to [Backlight] or [Spotlight] (📖 119), you can press the button to toggle between the respective light metering mode and [Standard].
- Adjust the exposure again if you change the metering mode after adjusting the exposure manually.

White Balance

The camera uses an electronic white balance process to calibrate the picture and produce accurate colors under different lighting conditions. The camera offers the following methods to set the white balance (which can be set to one of the WHITE BAL. switch positions, and switched as desired*).

You can also perform this function remotely using Browser Remote on a connected network device (📖 186).

* Available modes will depend on the WHITE BAL. switch position, as shown in the table below.

Auto white balance (AWB): The camera automatically adjusts the white balance to the optimal level.

Preset white balance: Set the white balance to ☀️ (daylight) or 💡 (tungsten lamp). You can further adjust the color temperature (K) value and the color compensation (CC) value, which adjusts the color along the green/magenta gradation.

Color temperature: Allows you to set the color temperature between 2,000 K and 15,000 K, and further adjust the color compensation (CC) value.

Custom white balance: You can use a gray card or white object with no pattern to establish the white balance and set it to one of two custom white balance positions, 🟩A or 🟩B. When recording under fluorescent lights, we recommend setting the custom white balance.

Available white balance methods by WHITE BAL. switch position

White balance method	WHITE BAL. switch position		
	B	A	PRESET
Preset white balance	–	–	●
Color temperature	–	–	●
Custom white balance	●	●	–

📘 NOTES

- When the camera is set to full auto mode, the white balance will be adjusted automatically (AWB). When infrared recording is activated, the white balance cannot be adjusted.
- The [White Balance] and [Color Matrix Tuning] settings in the custom picture file (📖 130) take precedence over the white balance set with these procedures.
- You can use the **MENU** > [📷 Camera Setup] > [Shockless WB] setting to make the transition look smoother when you change the white balance settings.
- When an RC-V100 Remote Controller is connected to the camera, you can adjust the white balance with the remote controller's AWB button, A button, B button, PRESET button and 🟩 button.
- The color temperatures displayed on the screen are approximate. Use them only as a reference.

Auto White Balance (AWB)

The camera constantly adjusts the white balance automatically to achieve an appropriate level. The camera will adjust the white balance if the light source changes.

Set the AWB switch to ON.

- The color temperature and CC value set automatically by the camera will appear at the bottom of the screen next to the **AWB** icon.

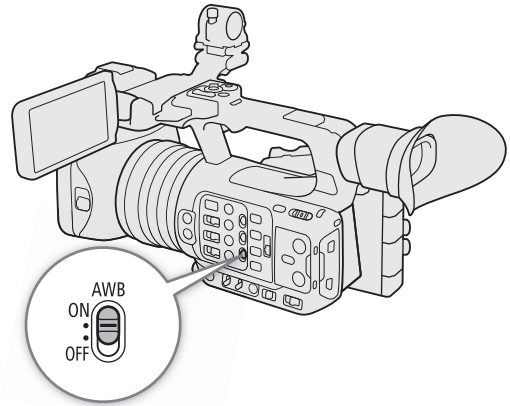

i NOTES

- Custom white balance may provide better results in the following cases:
 - Changing lighting conditions
 - Close-ups
 - Subjects in a single color (sky, sea or forest)
 - Under mercury lamps and certain types of fluorescent and LED lights
- You can use the **MENU** > [**Camera Setup**] > [AWB Response] setting to change how quickly the white balance changes in auto white balance (AWB) mode.
- If you set an assignable button to [AWB Lock] (119), you can press the button to lock the current white balance settings set automatically by the camera. To cancel the lock, press the button again (resume auto white balance mode) or select a different white balance setting.

Color Temperature/Preset White Balance

1 Set the AWB switch to OFF and the WHITE BAL. switch to PRESET.

2 Select a white balance mode using the direct setting mode (51).

- Select the or icon (preset white balance), or the icon (color temperature setting).
- To apply the stored preset setting or color temperature as is, the rest of the procedure is not necessary. To adjust the color temperature or CC value, continue the procedure.
- You can also use direct touch control (50).
- Alternatively, you can also use the **MENU** > [**Camera Setup**] > [White Balance: PRESET] setting to select in advance the white balance mode assigned to the WHITE BAL. switch's PRESET position.

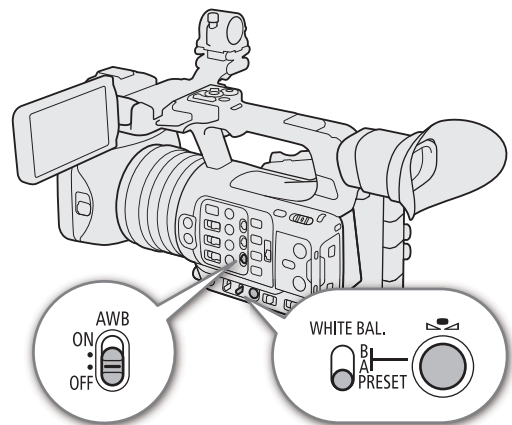

3 Press the button.

- The camera will enter the direct setting mode with the color temperature highlighted in orange. To adjust the CC value, push the joystick right.
- You can also adjust the color temperature or CC value using direct touch control (50).

4 Select the desired value.

- The selected color temperature and CC value will be set and will appear on the screen next to the white balance icon.

White balance mode/setting	Adjustment range	
	Color temperature (K)	Color compensation (CC) value
☀ (daylight)	4,300 K to 8,000 K	-5 to +5
☀ (tungsten lamp)	2,700 K to 3,700 K	
K (color temperature)	2,000 K to 15,000 K	-20 to +20

i NOTES

- You can use the **MENU** > [**☰** Camera Setup] > [C. Temp. Increment] setting to change the units for the color temperature increment to [Mired] (5-mired increments) or [Kelvin] (100-kelvin increments). Even when [Mired] is selected, the color temperature is converted to and displayed in kelvins. Changing this setting may change the white balance setting.
- If you set an assignable button to [☀ Daylight], [☀ Tungsten] or [**K** Kelvin] (📖 119), you can press the button to change the white balance mode temporarily. Press the button again to return to the previous white balance mode.

Custom White Balance

- 1 Set the AWB switch to OFF and the WHITE BAL. switch to either A or B.
 - To apply the stored custom white balance setting as is, the rest of the procedure is not necessary. To set a new custom white balance, continue the procedure.
- 2 Point the camera at a gray card or white object so that it fills the center of screen.
 - Use the same lighting conditions you plan to use when recording.
- 3 Press the **WB** button.
 - The **WB** A or **WB** B icon will flash quickly.
 - Make sure the gray card or white object fills the center of the screen until the procedure is completed.
 - Once the icon stops flashing, the procedure is completed. The setting is retained even if you turn off the camera.

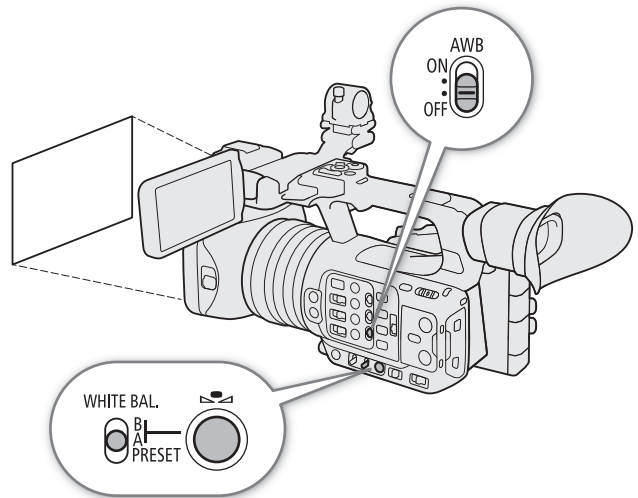

i NOTES

- Readjust the custom white balance if the light source or ND filter setting changes.
- Very rarely and depending on the light source, **WB** may keep flashing (it will change to a slow flashing). In that case, change the subject brightness and adjust the custom white balance again.
- After the camera registers a custom white balance, the color temperature or CC value may appear in gray. This indicates that the value registered exceeds the range of values that can be displayed but the white balance is correctly calibrated and you can continue shooting.

Zoom

You can operate the zoom using the zoom ring or one of the zoom rockers (grip/handle). In addition, you can choose the digital tele-converter function from the menu.

Selecting the Zoom Mode

Select **MENU** > [CAMERA] Camera Setup > [Digital Zoom] > Desired option.

Options

[Tele-converter 6.0x], [Tele-converter 3.0x], [Tele-converter 1.5x]:

The camera processes the image digitally to multiply the focal length by a factor of 6, 3 or 1.5, respectively.

[Digital 300x]: The camera uses the optical zoom up to 15x and processes the image digitally after that, up to a magnification ratio of 300x.

[Advanced 30x]¹:

The camera can zoom up to 30x combining the optical zoom and additional processing.

[Off]: The camera uses only the optical zoom up to 15x.

When you operate the zoom, a zoom indicator² will appear on the screen that shows the approximate zoom position. The white area³ of the zoom bar indicates the optical zoom range and the blue area⁴ indicates the digital zoom range.

¹ Only available when the resolution is 1920x1080 or 1280x720. However, it cannot be used if a shooting frame rate higher than 60 is set during slow & fast motion recording mode.

² You can use the **MENU** > [MONITORING] Monitoring Setup > [Custom Display 1] > [Zoom Indicator] setting to set the zoom indicator to a numerical display.

³ Even for options that combine optical zoom and additional processing like [Advanced 30x].

⁴ Only when [Digital 300x] is selected.



i NOTES

- You can attach the TL-U58 Tele-converter or WA-U58 Wide Attachment (both optional) to the camera (75). You can even use the TL-U58 in combination with the digital zoom and digital tele-converter functions.
- When an optional RC-V100 Remote Controller is connected to the camera, if [Digital Zoom] is set to one of the digital tele-converter options, the remote controller's EXTENDER indicator will light up.
- When **MENU** > [CAMERA] Camera Setup > [Conversion Lens] is set to [WA-U58], digital zoom and the digital tele-converter options are not available.

Selecting the Zoom Controls

Set the ZOOM switch to the desired position to select the physical controls you want to use to operate the zoom.

Options

RING: Turn the zoom ring to zoom.

ROCKER (other controls):

Use the grip zoom rocker, handle zoom rocker or a remote controller connected to one of the camera's REMOTE terminals to zoom.

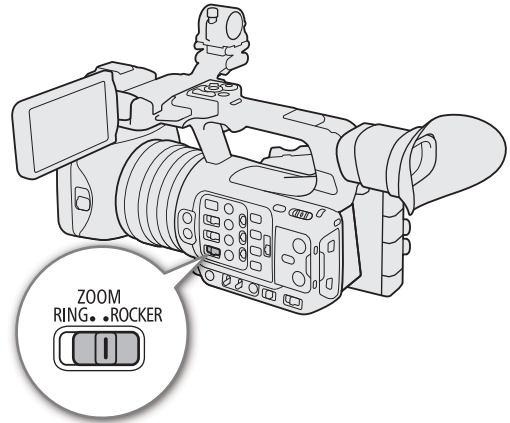

Using the Zoom Ring

The zoom speed depends on how fast you turn the zoom ring.

1 Set the ZOOM switch to RING.

2 Turn the zoom ring to zoom.

- The zoom ratio is determined by the position of the zoom ring.

i NOTES

- When you change the ZOOM switch's position from ROCKER to RING, the camera will zoom automatically to the focal length indicated by the current position of the zoom ring.
- You can operate the zoom ring even when the camera's controls are locked (📖 15).

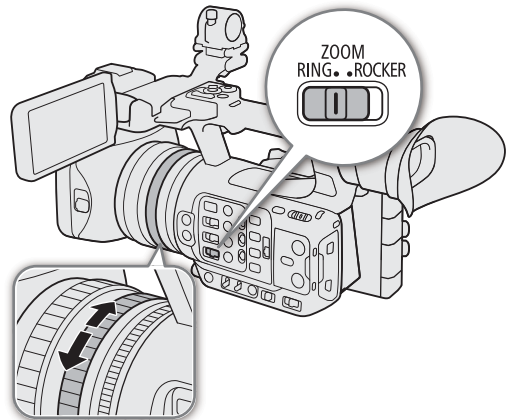

Using the Zoom Rockers

Set the ZOOM switch to ROCKER to operate the zoom using one of the zoom rockers (grip/handle). You can also use the RC-V100 Remote Controller or a commercially available remote control connected to the REMOTE terminal.

Using the Grip Zoom Rocker

You can set the zoom speed of the grip zoom rocker using the menu. With the [User Setting] you can even customize a zoom speed pattern depending on how much you press on the zoom rocker (73).

- 1 Set the ZOOM switch to **ROCKER**.
- 2 Move the zoom rocker toward **W** to zoom out (wide-angle) and toward **T** to zoom in (telephoto).

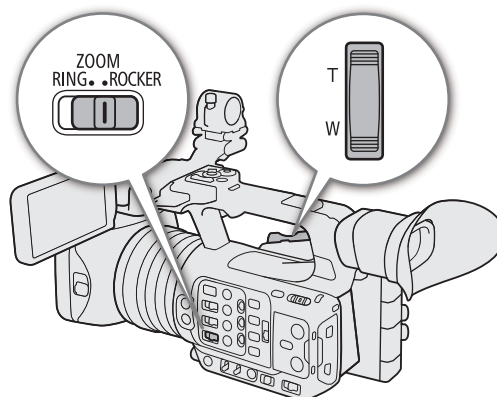

Grip zoom rocker: Approximate zoom speeds (time required to zoom end-to-end)

[Camera Setup] >		[Camera Setup] > [Zoom Speed Level]		
[Grip Zoom Speed]	[Constant Speed]	[Low]	[Normal]	[High]
[Constant]	[1] (slowest)	4 min 38 sec	2 min	1 min
	[16] (fastest)	4.2 sec	2.6 sec	0.9 sec*
[Variable]	–	4.2 sec – 4 min 38 sec	2.6 sec – 2 min	0.9 sec* – 1 min

* When the zoom speed is too fast, it will be more difficult to focus while zooming.

Setting the Zoom Speed (Grip Zoom Rocker)

- 1 Select **MENU** > [Camera Setup] > [Zoom Speed Level] > Desired option.
 - The selected speed will also be applied to the grip zoom rocker.
- 2 Select **MENU** > [Camera Setup] > [Grip Zoom Speed] > Desired option.

Options

[Constant]: Select one of 16 constant zoom speeds.

[Variable]: Variable zoom speed (zoom faster the harder you press).

[User Setting]: You can customize up to 3 zoom speed patterns, setting the desired zoom speed for 5 individual pressure levels. You can, for example, set a pattern where the grip zoom rocker only starts to react beyond a certain pressure level to avoid accidental zoom operations.

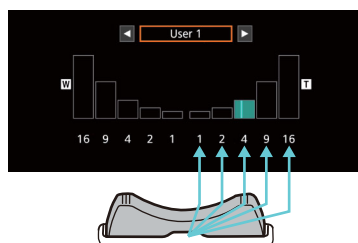

If you select [Constant]

- 3 Select **MENU** > [Camera Setup] > [Constant Speed] > Desired option.

If you select [User Setting]

- 3 Select **MENU** > [Camera Setup] > [User Setting] > Desired option ([User 1] to [User 3]) > [OK].
 - If you use the preset zoom speed pattern as is, the rest of the procedure is not necessary. Otherwise, continue the procedure to customize the zoom speed pattern.

4 Select [Edit].

5 Input the desired value (27).

- Select [Reset] to reset the zoom speed pattern to its preset values.

74

i NOTES

- When [Zoom Speed Level] is set to [High], the zoom motor's operation sound may be picked up in the recording.
- When **MENU** > [Camera Setup] > [High-Speed Zoom] is set to [On] and the grip rocker's zoom speed is set to [Variable], when you operate the zoom in record standby mode, the actual zoom speed will be as if the overall speed level were set to [High]. While recording, the zoom speed level will follow the speed level set in the menu.

Using the Handle Zoom Rocker

You can set the zoom speed of the handle zoom rocker using the menu.

1 Set the ZOOM switch to **ROCKER**.

2 Move the zoom rocker toward **W** to zoom out (wide-angle) and toward **T** to zoom in (telephoto).

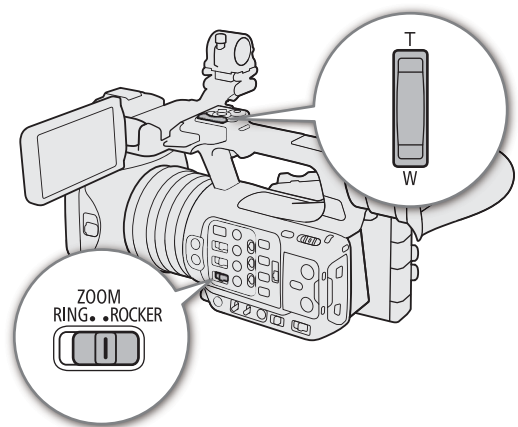

Handle zoom rocker: Approximate zoom speeds (time required to zoom end-to-end)

[Camera Setup] > [Handle Zoom Speed]	[Camera Setup] > [Zoom Speed Level]		
	[Low]	[Normal]	[High]
[1] (slowest)	4 min 38 sec	2 min	1 min
[16] (fastest)	4.2 sec	2.6 sec	0.9 sec*

* When the zoom speed is too fast, it will be more difficult to focus while zooming.

Setting the Zoom Speed (Handle Zoom Rocker)

1 Select **MENU** > [Camera Setup] > [Zoom Speed Level] > Desired option (73).

- The selected speed will also be applied to the handle zoom rocker.

2 Select **MENU** > [Camera Setup] > [Handle Zoom Speed] > Desired option.

Using a Remote Controller

You can operate the zoom using the RC-V100 Remote Controller or a commercially available remote control connected to the camera. The zoom speeds will differ depending on the controller.

Zoom speeds for remote operation

Accessory	Zoom speed
RC-V100 Remote Controller (optional)	Variable speed: The greater the angle at which the RC-V100's ZOOM dial is rotated from the center, the faster the zoom.
Commercially available remote controls	If the remote control does not support variable zoom: Constant zoom speed. If the remote control supports variable zoom: Variable zoom according to the remote control's settings.
Browser Remote	Fastest constant zoom speed. See the values under [16] in the previous table.

NOTES

- When an RC-V100 Remote Controller is connected to the camera, you can zoom with the remote controller's ZOOM dial. At default settings, turn the dial right to zoom in and left to zoom out.

Using Conversion Lenses

You can use the following conversion lenses with this camera. For details on the following accessories, refer to their respective instruction manuals.

Conversion Lens	Focal Length Factor	Minimum Focusing Distance
TL-U58 Tele-converter	Approx. 1.5x	Approx. 130 cm (4.3 ft.) throughout the zoom range
WA-U58 Wide Attachment	Approx. 0.8x	Approx. 60 cm (2.0 ft.) throughout the zoom range

Select **MENU** > [ Camera Setup] > [Conversion Lens] > Desired option.

- The image stabilization method, minimum focusing distance and the approximate distance to the subject displayed on the screen will change depending on the conversion lens selected.
- Select [Off] if you do not intend to use a conversion lens.

NOTES

- Vignetting may occur when taking wide angle shots with the optional TL-U58 Tele-converter.

Focus

The camera offers the following ways to focus. The camera incorporates Dual Pixel CMOS AF technology for advanced autofocus performance.

You can also adjust the focus remotely using Browser Remote on a connected network device (📖 188). Note that some methods allow you to operate aspects of the focus by touching the LCD screen.

Manual focus: Turn the focus ring on the lens to adjust the focus. The camera offers several focus assistance functions (📖 77) to help you focus more accurately when using the manual focus.

Push AF: While using manual focus, you can have the camera focus automatically as long as you hold the PUSH AF/MF button pressed down.

Push MF: While using autofocus, you can adjust the focus manually while the PUSH AF/MF button is pressed.

AF-Boosted MF*: Focus manually most of the way and let the camera finish focusing automatically.

Continuous AF*: The camera automatically keeps the subject inside the AF frame in focus at all times.

Face AF*: The camera automatically detects a person's face, focuses on it and can track it if that person moves.

Eye Detection: The camera detects and focuses automatically on a person's eyes, and tracks the subject if it moves.

Tracking: After you select a subject, the camera keeps focusing it and tracks the subject if it moves.

* You can also use the AF lock function (📖 119) to lock the current focus.

Manual Focus

Focus manually using the focus ring on the lens.

1 Set the FOCUS switch to M.

- **MF** appears on the left of the screen.

2 Turn the focus ring to adjust the focus.

i NOTES

- You can use the focus ring to adjust the focus. If the camera was initially in autofocus mode, it will return to autofocus mode after you adjust the focus manually.
- You can change the direction of the adjustment and the sensitivity of the response of the focus ring using the **MENU** > [📷 Camera Setup] > [Focus Ring Direction] and [Focus Ring Response] settings.
- If you operate the zoom after focusing, the focus on the subject may be lost.
- If you focus manually and then leave the camera with the power turned on, the focus on the subject may be lost after a while. This possible slight shift in focus is a result of the internal temperature rising in the camera and lens. Check the focus before resuming shooting.
- When an RC-V100 Remote Controller is connected to the camera, you can adjust the focus with the remote controller's FOCUS dial. At default settings, turn the dial right to focus farther and left to focus nearer.
- You can operate the focus ring even when the camera's controls are locked (📖 15).

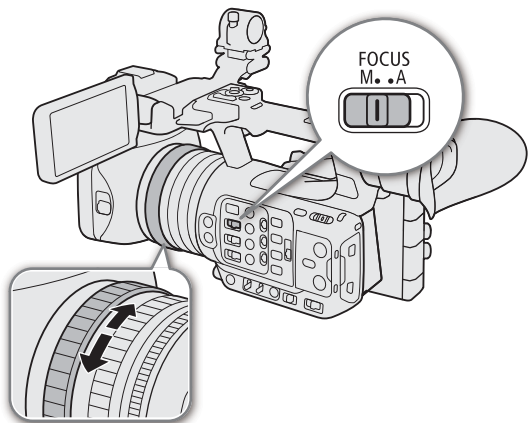

Using the Focus Assistance Functions

In order to focus more accurately, you can use the following focus assistance functions: Dual Pixel Focus Guide, an onscreen guide that shows you if the selected subject is in focus; peaking, which creates a clearer contrast by emphasizing the outlines of the subject; and magnification, which enlarges the image on the screen. You can use peaking and the focus guide or peaking and magnification simultaneously for greater effect.

Focus guide

The focus guide gives you an intuitive visual indication of the current focus distance and the direction and amount of adjustment necessary to bring the selected subject into full focus. When used in combination with face detection (📖 81), the guide will focus on the face of the person detected as the main subject. When eye detection (📖 81) is activated, the guide will focus on the eyes of the person detected as the main subject.

- 1 Using direct touch control (📖 50), you can touch the [Focus Guide] switch to turn on/off the focus guide.
 - Alternatively, you can use the **MENU** > [📷 Assistance Functions] > [Focus Guide] setting or an assignable button set to [Focus Guide] (📖 119), to display/hide the focus guide.
- 2 Touch the point where you want to focus on the LCD screen to move the focus guide.
 - You can also use the joystick to move the focus guide's frame. Press the CANCEL button to return the focus guide's frame to the center of the screen.
- 3 Adjust the focus manually as necessary.
 - The focus guide turns green when the subject is correctly focused or very close to it.

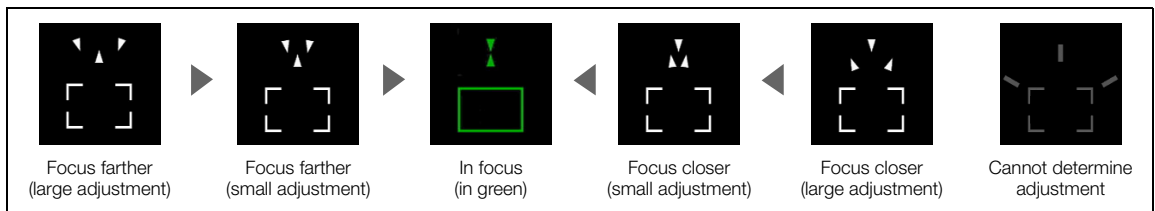

NOTES

- When the aperture is adjusted automatically, it may take a moment until the focus guide frame's response stabilizes after operating the zoom.
- With subjects or in situations where autofocus may not work well (📖 80), the focus guide may not work correctly.
- The focus guide cannot be used in the following cases:
 - While the focus is being adjusted automatically using AF-Boosted MF or continuous AF.
 - When **MENU** > [📷 Camera Setup] > [Digital Zoom] is set to [Tele-converter 6.0x] or [Tele-converter 3.0x], or to [Digital 300x] and the zoom ratio is in the digital zoom range.
 - When **MENU** > [📷 Camera Setup] > [Conversion Lens] is set to an option other than [Off].
 - While the color bars are displayed.
 - When the [Gamma] setting in the custom picture file (📖 128) is set to [PQ] or [HLG].
 - When infrared recording is activated.
 - When zooming.

Peaking

The camera offers two peaking levels.

1 Press the PEAKING button.

- The peaking icon (**PEAK1** or **PEAK2**) appears on the left of the screen and outlines (contour lines) in the image that are in focus will be shown highlighted.
- Press the button again to turn off peaking.
- You can use direct touch control (☐ 50) to turn the [Peaking 1]/[Peaking 2] setting on/off.
- Alternatively, you can use one of the **MENU** > [Assistance Functions] > [Peaking:] settings to turn the peaking function on/off separately on the respective terminal/output destination.

2 Select **MENU** > [Assistance Functions] > [Peaking] > [Peaking 1] or [Peaking 2].

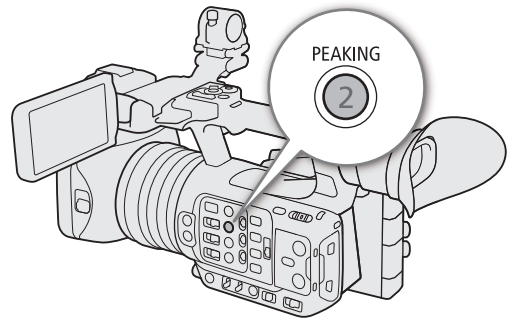

Magnification

1 Press the MAGN. button.

- **MAGN.** appears on the left of the screen and the center of the screen* is magnified 2 times.
- The orange frame displayed on the top right of the screen (magnification frame) shows the approximate part of the image shown magnified.
- Press SET to change the magnification in the following order: 2x → 5x → 10x.

2 If necessary, use the joystick to move around the magnification frame and check other parts of the image.

- You can also drag your finger across the LCD screen to move the frame.
- Press the CANCEL button to return the magnification frame to the center position.
- Press the MAGN. button again to cancel the magnification.

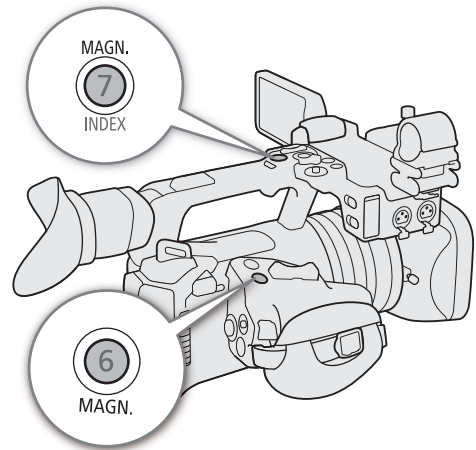

* If one of the AF frames or a face detection frame is displayed on the screen, the area around the active frame will be magnified instead.

i NOTES

• About Peaking/Magnification:

- You can use the **MENU** > [Assistance Functions] > [Peaking 1] and [Peaking 2] settings to set the color, gain and frequency of the two peaking levels independently of each other.
- You can use the **MENU** > [Assistance Functions] > [Magn. Output] setting to select where to show the magnified image.
- The assistance functions will not affect your recordings.
- Magnification will be turned off if you change the video configuration (☐ 53), the **MENU** > [Camera Setup] > [IS Mode] setting, or if you turn slow & fast motion recording on/off while the magnified image is displayed.
- Peaking/magnification are not available while the color bars are displayed.
- When **MENU** > [Assistance Functions] > [B&W during Magn.] is set to [On], the screen is set to black and white during magnification. The assistance functions will not affect your recordings.

Push AF/MF

When the focus mode is set to manual, the camera will focus automatically as long as you hold the PUSH AF/MF button pressed down. During autofocus, holding the PUSH AF/MF button pressed down will allow you to adjust the focus manually.

Press and hold the PUSH AF/MF button.

i NOTES

- The focus will be locked when Face AF is set to [Face Only] and a face has not been detected, or when [AF Mode] is set to [AF-Boosted MF] and the focus is outside of the automatic adjustment range.

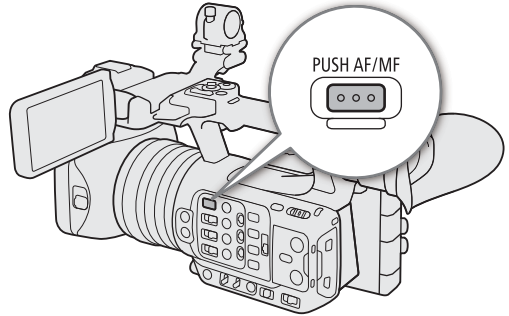

AF-Boosted MF

In this focus mode, you can focus manually most of the way and let the camera finish focusing automatically. This is very convenient when you want to make certain that high-resolution clips (4K and higher) are in sharp focus.

Additionally, with this mode, if the camera cannot evaluate how to adjust the focus, it will not perform unreliable focus adjustments. This results in a more stable focusing operation overall than with continuous AF.

1 Set the focus mode switch to automatic.

- **AF** appears on the screen.

2 Select **MENU** > [**Camera Setup**] > [AF Mode] > [AF-Boosted MF].

- When the focus is in the manual adjustment range, a yellow AF frame will appear on the screen.

3 If necessary, change the type and position of the AF frame (81).

4 Turn the focus ring to adjust the focus.

- Focus manually to bring the subject closer into focus. When the focus enters the automatic adjustment range, the focus frame will turn white and the camera will then finish focusing automatically.
- While the focus stays within the automatic adjustment range, the camera will keep the subject in focus automatically.

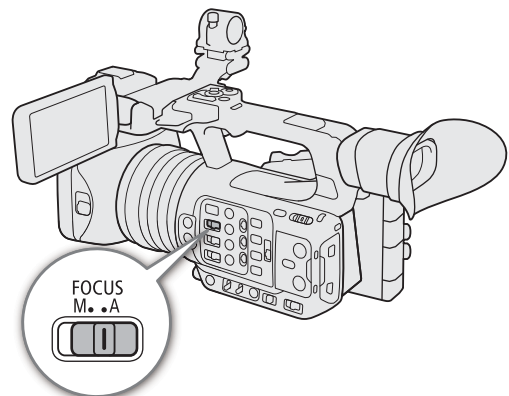

Continuous AF

The camera will focus automatically on a subject inside the main area of the image (approximately 80% of the screen's length and height).

1 Set the focus mode switch to automatic.

- **AF** appears on the screen.

2 Select **MENU** > [**Camera Setup**] > [AF Mode] > [Continuous].

- If [AF Frame] is set to either [Large] or [Small], a white AF frame will appear on the screen.
- When you are using Face AF, a white detection frame will appear around the face of the person who has been determined to be the main subject.

3 If necessary, change the type and position of the AF frame (📖 81).

i NOTES

About the autofocus (AF) functions:

- The point where the camera focuses may change slightly depending on shooting conditions, such as subject, brightness and zoom position. Check the focus before resuming shooting.
- Autofocus may take longer in the following cases.
 - When the frame rate set in the video configuration is 29.97P, 25.00P or 23.98P.
- You can change various aspects of the autofocus function with the following settings.
 - **MENU** > [**Camera Setup**] > [AF Speed] to set the AF speed (the speed at which the focus is adjusted) to one of 3 levels.
 - **MENU** > [**Camera Setup**] > [AF Response] to set the responsiveness of the autofocus function to one of 3 levels.
- The autofocus settings cannot be used in the following cases.
 - When **MENU** > [**Camera Setup**] > [Digital Zoom] is set to [Tele-converter 6.0x] or [Tele-converter 3.0x].
 - When **MENU** > [**Camera Setup**] > [Conversion Lens] is set to either [TL-U58] or [WA-U58].
 - When the [Gamma] setting in the custom picture file (📖 128) is set to [PQ] or [HLG].
 - When infrared recording is activated.
- Autofocus may not work well on the following subjects or in the following cases. In such case, focus manually.

- Reflective surfaces	- Through dirty or wet windows
- Subjects with low contrast or without vertical lines	- Night scenes
- Fast moving subjects	- Subjects with a repetitive pattern

 - When using small apertures.
 - When subjects at different distances appear in the picture.
 - When the gamma curve component of the [Gamma/Color Space] setting in the custom picture file (📖 128) is set to an option other than [BT.709 Normal] or [BT.709 Standard].

Changing the AF Frame Type and Position

You can change the type and position of the AF frame that appears on the screen (except for the face detection/tracking frame) while using one of the autofocus functions.

- 1 Select **MENU** > [Camera Setup] > [AF Frame Position] > Desired option.
- 2 Select **MENU** > [Camera Setup] > [AF Frame] > Desired option.

Options for [AF Frame Position]

[Selectable]: You can move the AF frame by touching the desired point on the LCD screen. You can also use the joystick (4 directions). Press the CANCEL button to return the AF frame to the center of the screen.

[Center Frame]: A fixed AF frame appears at the center of the screen.

Options for [AF Frame]

[Whole Area]*: No AF frame is displayed. The camera focuses automatically on a subject at the center of the screen.

[Large]: Standard AF frame size.

[Small]: Smaller AF frame size (about 1/3 the standard size).

* Only available when **MENU** > [Camera Setup] > [AF Mode] is set to [Continuous].

NOTES

You cannot change the type and position of the AF frame in the following cases.

- When **MENU** > [Camera Setup] > [Digital Zoom] is set to [Tele-converter 6.0x] or [Tele-converter 3.0x].
- When **MENU** > [Camera Setup] > [Digital Zoom] is set to [Digital 300x] and the zoom position is in the digital zoom range.
- When **MENU** > [Camera Setup] > [Conversion Lens] is set to either [TL-U58] or [WA-U58].
- When the [Gamma] setting in the custom picture file (128) is set to [PQ] or [HLG].
- While the color bars are displayed.
- When infrared recording is activated.

Face Detection

When the face detection function is activated, the camera will detect people's faces. When there are a number of people in the picture, one person will be determined to be the main subject. The camera will keep tracking the main subject even when it moves. It is also possible to track the eyes of the main subject (Eye Detection) and adjust the brightness automatically (Face Detection AE).

You can use face detection with one of the autofocus functions to let the camera focus on the main subject automatically (Face AF). You can use the focus guide to adjust the focus on the main subject manually. You can also change the main subject.

- 1 Select **MENU** > [Camera Setup] > [Face Det. & Tracking] > [On].
- 2 Select **MENU** > [Camera Setup] > [Face AF] > Desired option when a face is not detected.
 - (face priority) or (face-only AF) will appear on the screen.
 - Continue to step 5 if [Eye Detection] or [Face Detection AE] are not required.
- 3 Select **MENU** > [Camera Setup] > [Eye Detection] > [On].
- 4 Select **MENU** > [Camera Setup] > [Face Detection AE] > [On].

5 Point the camera at a person.

- All detected faces will have a face detection frame. The main subject will be indicated with a face detection frame with small arrows (white when autofocus is active, gray or yellow* during manual focus). If eye detection is enabled, a frame will appear on the eyes of the main subject.
- Push the joystick (left/right) to select a different person as the main subject. When eye detection is enabled and both eyes have been detected, you can push the joystick (left/right) to select either eye.
- During continuous AF, the camera will keep focusing on the main subject's face/eyes.
- If you use face detection together with the tracking function, the camera will be able to track the selected main subject more reliably. When you touch a subject on the LCD screen, tracking will be activated and the face detection frame will change to a double frame  (tracking frame). This is better if you want to track a subject when it is difficult to keep seeing their face.



* [AF-Boosted MF] within manual adjustment range.

Options



[Face Priority]: The camera focuses according to the AF mode currently selected.

[Face Only]: The camera locks the focus.

Face AF operation by AF mode

MENU > [ Camera Setup] > [AF Mode] and focus operation	MENU > [ Camera Setup] > [Face AF]			
	[Face Priority]		[Face Only]	
	Face detected	No face detected	Face detected	No face detected
[Continuous] (autofocus), [AF-Boosted MF] within the automatic adjustment range	Focus on the detected face	Focus on the subject inside the AF frame	Focus on the detected face	Manual focus
[AF-Boosted MF] within the manual adjustment range (yellow AF frame)	Manual focus			

NOTES



- Typical examples of faces not correctly detected
 - Faces extremely small, large, dark or bright in relation to the overall picture.
 - Faces that are turned to the side, at a diagonal, partially hidden or upside-down.
- Face detection AF, tracking and eye detection cannot be used in the following cases.
 - When the shutter speed used is slower than 1/30 (59.94 Hz system recordings), 1/25 sec (50.00 Hz recordings), or 1/24 sec (59.94 Hz recordings with a 23.98P frame rate), except when slow & fast motion recording mode is activated.
 - When slow & fast motion recording mode is activated with a frame rate lower than 24P.
 - When **MENU** > [ Camera Setup] > [Digital Zoom] is set to [Digital 300x] and the zoom ratio exceeds 60x.
 - When **MENU** > [ Camera Setup] > [Digital Zoom] is set to [Tele-converter 6.0x].
 - When infrared recording is activated.
- Face detection AE cannot be used in the following cases.
 - When shutter speed, ISO speed/gain and aperture are set to manual.
 - When the light metering mode is set to [Spotlight].
- The camera may mistakenly detect the faces of non-human subjects. In such case, turn face detection & tracking off.
- If you set an assignable button to [Face Det. & Tracking], [Eye Detection], [Face AF] or [Face Detection AE] ( 119), you can press the button to adjust those settings.

Tracking a Specific Subject







You can have the camera track other moving subjects that are not faces and also combine the tracking function with one of the autofocus functions to let the camera focus on the desired subject automatically.

When [AF Mode] is set to [Continuous] and [AF Frame] is set to [Whole Area]

Touch the desired subject on the LCD screen.

- A double frame  (tracking frame) is displayed and the camera will start tracking the selected subject.
- Press the CANCEL button to remove the frame and cancel the tracking.
- If tracking fails,  will be displayed. Select the desired subject again.

When [AF Frame] is set to [Whole Area], [Large] or [Small]

- 1 Set an assignable button to [Tracking] ( 119).
- 2 Press the assignable button.
 - The subject selection mark  will appear on the screen.
 - Press the assignable button again or the CANCEL button to end the subject selection mode.
- 3 Touch the desired subject on the LCD screen.
 - The  mark changes to a double frame  (tracking frame) and the camera will start tracking the selected subject.
 - You can also use the joystick (4 directions) to place the center of the  mark on the desired subject and then press SET.
 - If the tracking failed, the  mark will turn red momentarily. Select the subject again.
 - The subject selected for tracking becomes the target for autofocus functions.
- 4 Press SET or the button assigned to [Tracking].
 - The camera stops tracking and returns to subject selection mode.
 - Press the CANCEL button to end the tracking function and return the camera to the focus mode that was used previously.

NOTES

- The camera may start tracking the incorrect subject if there is another subject in the picture with similar color/pattern characteristics. In that case, select the desired subject again.
- Tracking cannot be used in the same cases in which face detection AF and eye detection cannot be used ( 82).

Focus Limit and Macro Shooting

By default, the camera's focus range allows macro shooting. You can activate the focus limit to restrict the focus range. The focus range (1 cm (0.39 in.; at full wide-angle) to ∞) will be limited to 60 cm (2 ft.) to ∞ (throughout the entire zoom range).

Select **MENU** > [ Camera Setup] > [Focus Limit] > [On].

Image Stabilization

You can use the image stabilizer to compensate for camera shake and achieve steadier shots. Select an IS mode that best fits your needs. When you are stationary and zooming in on far subjects using high zoom ratios, it is possible to compensate for a high degree of camera shake by using Powered IS.

Dynamic IS (👉): Dynamic IS compensates for a higher degree of camera shake, such as when shooting while walking, and is more effective as the zoom approaches full wide angle.

Standard IS (👉): Standard IS compensates for a lower degree of camera shake, such as when shooting while remaining stationary, and is suitable for shooting natural-looking scenes.

Powered IS (👉): Powered IS is most effective when you are stationary and zooming in on far subjects using high zoom ratios (approaching the telephoto end). This mode is not suitable for tilting and panning shots.

1 Select **MENU** > [**Camera Setup**] > [**IS Mode**] > Desired option.

- Press the button assigned to [IS Mode] to turn switch between IS modes (📖 119).

2 Select **MENU** > [**Camera Setup**] > [**Image Stabilizer**] > [On].

- The (👉) or (👉) icon appears on the screen.
- Select [Off] instead to turn off the image stabilization, for example, when recording with the camera mounted on a tripod.
- If you set an assignable button to [Image Stabilizer] (📖 119), you can press the button to turn this setting on/off.

3 If a higher level of image stabilization is required, press the **POWERED IS** button.

- (👉) appears on the left of the screen.
- Press the button again to return the camera to the IS mode set in the menu.
- Alternatively, you can also use the **MENU** > [**Camera Setup**] > [**Powered IS**] setting to turn Powered IS on and off.

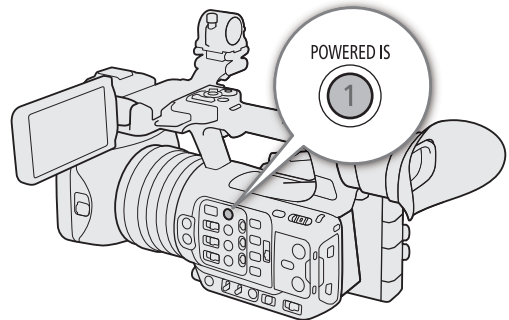

i NOTES

- If the degree of camera shake is too high, the image stabilizer may not be able to compensate fully.
- When using Dynamic IS, the edges of the picture may be adversely affected (ghosting, artifacts and/or dark areas may appear) when compensating for a high degree of camcorder shake.
- The screen will turn black momentarily when you switch between Dynamic IS and Standard IS or vice versa.
- You cannot switch between Dynamic IS and Standard IS while recording.
- When using Dynamic IS, the angle of view will be narrower.

Onscreen Markers, Zebra Patterns and False Color

Using onscreen markers allows you to make sure your subject is correctly framed and is within the appropriate safe area. Zebra patterns help you identify areas that are overexposed. The false color overlay allows you to check if the exposure is correct. You can display the assistance overlays independently on the screen, SDI OUT terminal and HDMI OUT terminal. The assistance overlays will not affect your recordings.

Displaying Onscreen Markers

The camera offers several onscreen markers. You can display multiple onscreen markers simultaneously and select their color individually.

[Center Marker]: Displays a small marker that indicates the center of the screen. You can select the shape of the center marker.

[Horizontal Marker], [Vertical Marker]: Displays a horizontal or vertical line to help you compose level shots.

[Grid Marker]: Displays a grid that allows you to frame your shots correctly (horizontally and vertically).

[Aspect Marker]: Indicates various aspect ratios by displaying border lines or by masking the image outside the selected aspect ratio. The aspect ratio can be set freely by the user.

[Safe Area Marker]: Displays a margin from the edges of the image (using border lines or by masking the image) to indicate the action safe area, text safe area, etc. You can select the core area used as the basis for calculating the safe area and a percentage, relative to the side length or area.

[User Marker 1], [User Marker 2]: Displays up to two rectangular frames whose size and position you can set freely and independently of each other.

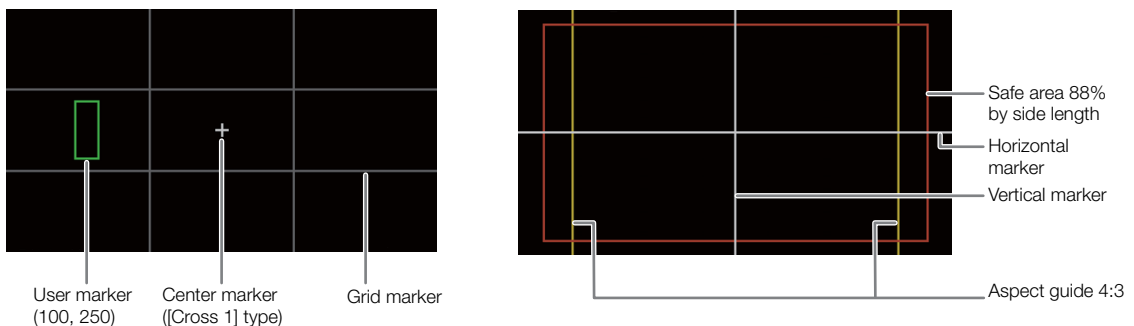

1 Select **MENU** > [ Assistance Functions] > Desired [Markers:] setting > [On].

- Onscreen markers will be displayed on the corresponding video output.
- You can also use direct touch control ( 50) to turn the [Markers: LCD] setting on/off.
- If the respective setting is set to [Off], onscreen markers will not be displayed on the corresponding video outputs even if individual markers are configured.

2 Select the marker(s) you wish to display and configure them with the following procedures.

- You can display multiple markers simultaneously.

Center Marker / Horizontal Marker / Vertical Marker / Grid Marker

1 Select **MENU** > [ Assistance Functions] > [Center Marker], [Horizontal Marker], [Vertical Marker] or [Grid Marker] > Desired marker color.

- Select [Off] to turn off the marker.

2 For [Center Marker] only: Select **MENU** > [Assistance Functions] > [Center Marker Type] > Desired marker shape.

Aspect Marker

- 1 Select **MENU** > [Assistance Functions] > [Aspect Marker] > Desired marker color or transparency of the masked area.
 - Select [Off] to turn off the marker.
- 2 Select **MENU** > [Assistance Functions] > [Marker Aspect Ratio] > Desired option.
- 3 For [Custom] only: Select **MENU** > [Assistance Functions] > [Marker Custom Asp. Ratio] and enter the aspect ratio using the data entry screen (27).

NOTES

Aspect markers will not be displayed in the following cases.

- When the marker aspect ratio is set to [16:9].
- The same applies when the aspect ratio is set manually to [1.78:1] using [Custom].

Safe Area Marker

The safe area is displayed using a border line or by masking the image outside the safe area. It can be calculated as a percentage of the total frame area or as a percentage of the width/height.

- 1 Select **MENU** > [Assistance Functions] > [Safe Area Marker] > Desired marker color/mask opacity level.
 - Select [Off] to turn off the marker.
- 2 Only when an aspect marker is already activated: Select **MENU** > [Assistance Functions] > [Basis for Marker Safe Area] > [Whole Picture] or [Selected Aspect Marker].
- 3 Select **MENU** > [Assistance Functions] > [Marker Safe Area %] > Desired percentage.
 - You can select the margin as a percentage of the total frame area [(Area)] or as a percentage of the width/height [(Side Length)].

User Markers

You can set 2 individual user markers ([User Marker 1] and [User Marker 2]) and adjust their color, size and position separately.

- 1 Select **MENU** > [Assistance Functions] > [User Marker 1] or [User Marker 2] > Desired marker color.
 - Select [Off] to turn off the marker.
- 2 Select **MENU** > [Assistance Functions] > [User Marker 1 Size] or [User Marker 2 Size] and enter the width [W] and height [H] using the data entry screen (27).
- 3 Select **MENU** > [Assistance Functions] > [User Marker 1 Position] or [User Marker 2 Position] and enter the [X] and [Y] coordinates using the data entry screen (27).

NOTES

- You can choose the onscreen display level to turn off all other onscreen displays, leaving only the markers (46).
- If you set an assignable button to one of the [Markers:] settings (119), you can press the button to turn the markers on and off on the corresponding video output.

Displaying Zebra Patterns

The camera has a zebra pattern function that shows black and white diagonal stripes over areas that are overexposed. There are two types of zebra patterns and you can display both simultaneously. Zebra 1 lets you identify areas within a certain range ($\pm 5\%$ of a specified level from 5% to 95%) while zebra 2 lets you identify areas that exceed a specified level (from 0% to 100%).

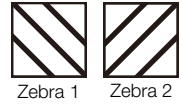

- 1 Press the ZEBRA button to activate the selected zebra pattern on all monitoring devices at once.
 - You can also use direct touch control (📖 50) to turn the [Zebra: LCD] setting on/off.
 - Alternatively, you can press an assignable button set to one of the [Zebra:] settings (📖 119), to turn the zebra pattern overlay on and off on the corresponding video output.
- 2 Select **MENU** > [🔧 Assistance Functions] > [Zebra] > Desired option.
- 3 Select **MENU** > [🔧 Assistance Functions] > [Zebra 1 Level] or [Zebra 2 Level] > Desired option.

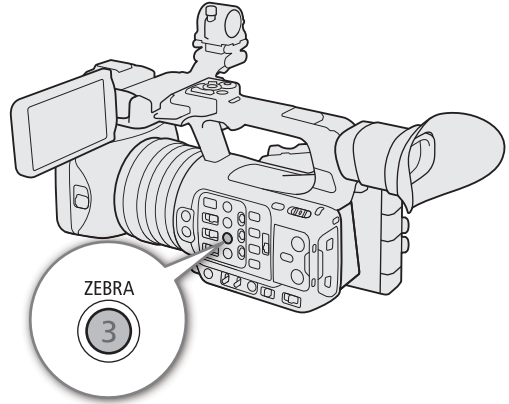

Displaying False Color

In CAMERA mode, you can display the false color overlay to check the brightness levels as different colors.

Select **MENU** > [🔧 Assistance Functions] > Desired [False Color:] setting > [On].

- You can also use direct touch control (📖 50) to turn the [False Color: LCD] setting on/off.
- Alternatively, you can press an assignable button (📖 119) set to one of the [False Color:] settings to turn the false color overlay on and off on the corresponding output destination.

i NOTES

- You can use the **MENU** > [🔧 Assistance Functions] > [False Color Index] setting to check an index of the colors used in the false color overlay.

Color	Meaning
Red	White clipping
Yellow	Just below white clipping
Pink	One stop over 18% gray
Green	18% gray (medium gray)
Blue	Just above black clipping
Purple	Black clipping

- When the Look File registered to the custom picture file is active, the color displayed might not be that of the correct brightness level.

Setting the Time Code

The camera generates a time code signal and records it with the recorded clips. The time code signal can be output from the SDI OUT terminal, TIME CODE terminal or HDMI OUT terminal.

Depending on the frame rate used, you may be able to select between a drop frame and a non-drop frame time code signal (89). The default mode varies depending on the country/region of purchase and, though the time code display style is different for DF and NDF, in this section the NDF display style is used for simplicity's sake.

Selecting the Time Code Mode

You can select the camera's time code mode.

Select **MENU** > [👉 System Setup] > [Time Code Mode] > Desired option.

Options

- [Preset]: The time code starts from an initial value you can select in advance. The default initial time code is 00:00:00:00.
See the following procedures to select the time code running mode and set the initial time code.
- [Regen.]: The camera will read the selected card and the time code will continue from the last time code recorded on the card. The time code runs only while recording so clips recorded consecutively on the same card will have continuous time codes.

Setting the Time Code Running Mode

If you set the time code mode to [Preset], you can select the time code running mode.

Select **MENU** > [👉 System Setup] > [Time Code Run] > Desired option.

Options

- [Rec Run]: The time code runs only while recording so clips recorded consecutively on the same card will have continuous time codes.
- [Free Run]: The time code starts running the moment you confirm the selection and keeps running regardless of the camera's operation.

Setting the Time Code's Initial Value

If you set the time code mode to [Preset], you can set the initial value of the time code.

- 1 Select **MENU** > [👉 System Setup] > [Set Time Code] > [Change].
 - The time code setting screen appears with an orange selection frame indicating the hours.
 - To reset the time code to [00:00:00:00], select [Reset] instead. If the running mode is set to [Free Run], the time code will be reset the moment you confirm the selection and keep running continuously from 00:00:00:00.
- 2 Enter the initial time code using the data entry screen (27).
 - If the running mode is set to [Free Run], the time code will start running from the selected time code the moment you confirm the selection.

Selecting Drop or Non-Drop Frame

When the frame rate is set to 59.94P, 59.94i or 29.97P, you can select between a drop frame (DF) or non-drop frame (NDF) time code, depending on how you plan to use your recordings.

With all other frame rates, the time code is set to non-drop frame (NDF) and cannot be changed.

Select **MENU** > [ System Setup] > [Time Code DF/NDF] > Desired option.



- The time code display will change depending on the setting. When you select [DF], the time code will appear as [00:00:00.00]; when you select [NDF], it will appear as [00:00:00:00].

About the time code display

A letter may appear next to the time code depending on the setting/status. Refer to the following table.

Letter	Description
R	The time code mode is set to [Regen.].
P	The time code mode is set to [Preset] and the running mode is set to [Rec Run].
F	The time code mode is set to [Preset] and the running mode is set to [Free Run].
E	The time code signal is coming from an external source.
No letter	Time code during clip playback.

NOTES

- The frames value of the time code runs from 0 to 23 (frame rate set to 23.98P), from 0 to 24 (frame rate set to 25.00P, 50.00i or 50.00P), or from 0 to 29 (all other frame rates).
- When slow & fast motion recording, frame recording or interval recording are activated, you cannot select the [Free Run] running mode. Conversely, when pre-recording is activated, [Free Run] is set automatically and cannot be changed.
- When slow & fast motion recording, frame recording or interval recording are activated, the time code signal will not be output from any of the terminals.
- When you mix drop frame and non-drop frame time codes, there might be a discontinuity in the time code at the point where the recording starts.
- When you are using the [Free Run] running mode, the time code will continue running as long as the built-in backup battery has some charge left, even if you disconnect all other power sources.
- If you set an assignable button to [Time Code] ( 119), you can press the button to open the [ System Setup] menu page with the time code settings.

Setting the User Bit

You can set a user bit composed of the date or the time of recording or an identification code consisting of 8 characters in the hexadecimal system. There are sixteen possible characters: the numbers 0 to 9 and the letters A to F.

The user bit is recorded with clips and can be output from the SDI OUT terminal, TIME CODE terminal or HDMI OUT terminal. It can be used freely to categorize and manage recordings or to keep additional information about them.

1 Select **MENU** > [ System Setup] > [User Bit Type] > [Setting], [Date] or [Time].

- If you select [Time] or [Date] the rest of the procedure is not necessary.

2 Select [Change].

- To reset the user bit to [00 00 00 00], select [Reset] instead.

3 Enter the user bit using the data entry screen ( 27).

Synchronizing with an External Device

You can use the camera's TIME CODE terminal to synchronize this camera's time code to an external signal. Using the same external time code signal with multiple cameras allows you to set up a multi-camera recording. You can output the time code signal from this camera to other cameras. You can also output the time code signal from the SDI OUT terminal to an editing device (while recording or during playback), so the editor can create video with the same time code.

Additionally, you can use the G-LOCK/SYNC terminal to synchronize this camera's video signal to a reference signal* from an external video device (Genlock synchronization) or to send out the camera's video signal as a synchronization reference signal*.

* As reference video signal (input signal) for Genlock synchronization, you can use an analog blackburst or tri-level HD signal. The reference video output signal will be a tri-level HD signal.

Connecting an External Device

When synchronizing a time code signal, connect the external device to the TIME CODE terminal on the camera. When synchronizing with a reference video signal, connect the external device to the G-LOCK/SYNC terminal. Be sure to set either terminal to input or output in advance.

Connection diagram

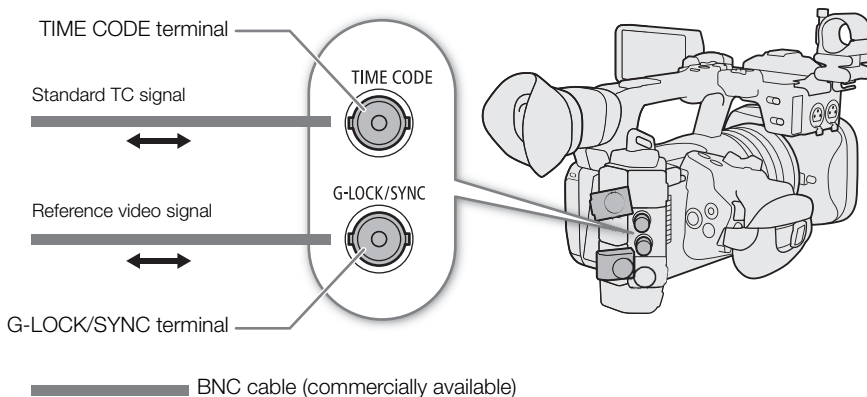

Time Code Signal Input

An external SMPTE-standard LTC timing signal received from the TIME CODE terminal can be recorded as the time code. The user bit of the external timing signal can also be recorded with clips. Before connecting the device, set the TIME CODE terminal to input with the procedure below and make sure the time code running mode is set to [Free Run] (88).

- 1 Select **MENU** > [System Setup] > [TC In/Out] > [In].
- 2 To record the external signal's user bit, select also **MENU** > [System Setup] > [User Bit Recording Mode] > [External].

i NOTES

- Synchronize the camera's time code with an external time code signal that matches the camera's system frequency. Use a 24-frame time code signal when the frame rate is set to 23.98P, a 25-frame time code signal when it is set to 25.00P, 50.00i or 50.00P and a 30-frame time code signal for other frame rates.

- When a suitable external time code signal is received, the camera's own time code will be synchronized to it and the synchronization will be maintained even if you disconnect the cable from the TIME CODE terminal.
- If the external time code signal is incorrect or there is no input signal, the internal time code set in the camera will be recorded instead.
- When an external time code signal is received, the DF/NDF selection will follow the external time code signal's settings.
- If an external time code signal is input while pre-recording is activated, there might be a discontinuity in the time code of the pre-recorded clip.
- Performing any of the following actions while the cable is not connected will cause the synchronization to be disrupted; the correct time code will be restored once you reconnect the cable.
 - Turning the camera on/off
 - Switching to MEDIA mode
 - Changing the video configuration

Time Code Signal Output

The time code signal output from the TIME CODE terminal will be a SMPTE-standard LTC timing signal. The user bit will also be output.

Select **MENU** > [**⚙** System Setup] > [TC In/Out] > [Out].

NOTES

- **About the user bit output:** The user bit set by the user ( 90) will be output. In MEDIA mode, the user bit is not output from the TIME CODE terminal.
- The time code and user bit will not be output when slow & fast motion recording, frame recording or interval recording are activated.

Reference Video Signal Input (Genlock Synchronization)

When a reference sync signal (analog blackburst or tri-level signal) is input through the G-LOCK/SYNC terminal, the phases of the camera's V and H sync will automatically be synchronized to it. The phase difference between the external Genlock signal and the camera is initially set to 0. The H phase can be adjusted within the range of approximately ± 0.4 H.

1 Select **MENU** > [**⚙** System Setup] > [G-LOCK/SYNC Term.] > [Genlock Input].

2 Select **MENU** > [**⚙** System Setup] > [Genlock Adjustment] > [Change].

- To reset the adjustment value to [000], select [Reset] instead.

3 Enter the H-phase adjustment value using the data entry screen ( 27).

NOTES

- When a suitable Genlock signal is input, the Genlock synchronization stabilizes after approximately 10 seconds.
- When a suitable Genlock signal is detected, the **Gen.** icon will flash at the top right of the screen. When the camera locks on the external Genlock signal, the icon will stay on.
- If the external Genlock signal is incorrect, the synchronization may not be stable. In such case, the recorded time code may be incorrect.

Reference Video Signal Output

After changing the function of the G-LOCK/SYNC terminal, you can use the camera's video signal as a reference sync signal (tri-level HD signal) to synchronize an external device to this camera. The reference signal's configuration is determined by the video output configuration of the SDI OUT terminal and other menu settings.

- 1 Select **MENU** > [👉 System Setup] > [G-LOCK/SYNC Term.] > [HD Sync Output].
- 2 If necessary, select **MENU** > [👉 System Setup] > [SYNC Scan Mode] > [P] or [PsF].

Recording Audio

The camera features the following options for audio recording and playback. You can record audio using an external microphone/line-in device (INPUT terminal / MIC terminal), or the built-in microphone.

The audio signal will be output with the video signal from the SDI OUT terminal or HDMI OUT terminal. You can record the audio signal on an external recorder.

Available audio recording formats

	Video format / audio recording function	Audio format				
		Codec	Sampling frequency	Bit depth	Number of audio channels	Bit rate
Video recording	XF-AVC	Linear PCM	48 kHz	24 bit	4 channels	4.5 Mbps
	MP4*	Linear PCM		16 bit	4 channels	3 Mbps
		AAC		16 bit	2 channels	256 Kbps
Audio recording	For slow & fast motion recording	–	48 kHz	24 bit	4 channels	4.5 Mbps
	For second card recording functions	–	8 kHz	16 bit	1 channel	128 Kbps

* Audio for proxy clips is recorded in AAC format.

Audio Settings and Recorded Audio Channels

Menu settings			Recorded audio channels/audio sources			
[Audio Input Selection] ¹		[CH2 Input] ¹	CH1	CH2	CH3	CH4
[CH1/CH2]	[CH3/CH4]					
[INPUT Terminals]	[INPUT Terminals] ²	[INPUT 2]	INPUT 1 terminal	INPUT 2 terminal	INPUT 1 terminal	INPUT 2 terminal
[INPUT Terminals]	[INPUT Terminals] ²	[INPUT 1]	INPUT 1 terminal	INPUT 1 terminal	INPUT 1 terminal	INPUT 2 terminal
[INPUT Terminals]	[MIC Terminal]	[INPUT 2]	INPUT 1 terminal	INPUT 2 terminal	MIC terminal (L)	MIC terminal (R)
[INPUT Terminals]	[MIC Terminal]	[INPUT 1]	INPUT 1 terminal	INPUT 1 terminal	MIC terminal (L)	MIC terminal (R)
[INPUT Terminals]	[MIC Terminal]	[MIC Terminal]	INPUT 1 terminal	MIC terminal (L + R)	MIC terminal (L)	MIC terminal (R)
[INPUT Terminals]	[Built-in Mic]	[INPUT 2]	INPUT 1 terminal	INPUT 2 terminal	Built-in microphone (L)	Built-in microphone (R)
[INPUT Terminals]	[Built-in Mic]	[INPUT 1]	INPUT 1 terminal	INPUT 1 terminal	Built-in microphone (L)	Built-in microphone (R)
[INPUT Terminals]	[Built-in Mic]	[Built-in Mic]	INPUT 1 terminal	Built-in microphone (L + R)	Built-in microphone (L)	Built-in microphone (R)
[INPUT Terminals]	[Multi-Function Shoe] ³	[INPUT 2]	INPUT 1 terminal	INPUT 2 terminal	Audio terminal (commercially available accessory)	Audio terminal (commercially available accessory)
[INPUT Terminals]	[Multi-Function Shoe] ³	[INPUT 1]	INPUT 1 terminal	INPUT 1 terminal	Audio terminal (commercially available accessory)	Audio terminal (commercially available accessory)
[MIC Terminal]	[INPUT Terminals] ²	–	MIC terminal (L)	MIC terminal (R)	INPUT 1 terminal	INPUT 2 terminal
[MIC Terminal]	[MIC Terminal]	–	MIC terminal (L)	MIC terminal (R)	MIC terminal (L)	MIC terminal (R)
[MIC Terminal]	[Built-in Mic]	–	MIC terminal (L)	MIC terminal (R)	Built-in microphone (L)	Built-in microphone (R)
[MIC Terminal]	[Multi-Function Shoe] ³	–	MIC terminal (L)	MIC terminal (R)	Audio terminal (commercially available accessory)	Audio terminal (commercially available accessory)

Menu settings			Recorded audio channels/audio sources			
[Audio Input Selection] ¹		[CH2 Input] ¹	CH1	CH2	CH3	CH4
[CH1/CH2]	[CH3/CH4]					
[Built-in Mic]	[INPUT Terminals] ²	–	Built-in microphone (L)	Built-in microphone (R)	INPUT 1 terminal	INPUT 2 terminal
[Built-in Mic]	[MIC Terminal]	–	Built-in microphone (L)	Built-in microphone (R)	MIC terminal (L)	MIC terminal (R)
[Built-in Mic]	[Built-in Mic]	–	Built-in microphone (L)	Built-in microphone (R)	Built-in microphone (L)	Built-in microphone (R)
[Built-in Mic]	[Multi-Function Shoe] ³	–	Built-in microphone (L)	Built-in microphone (R)	Audio terminal (commercially available accessory)	Audio terminal (commercially available accessory)

¹ Menu items under the [AUDIO] Audio Setup] menu.

² Changes to [INPUT Terminals (Camera)] when a commercially available accessory compatible with the multi-function shoe is attached.

³ Only displayed when a commercially available accessory compatible with the multi-function shoe is attached.

NOTES

- You can press the AUDIO STATUS button to display only the [AUDIO] Audio Setup] status screens. On these status screens (212) you can check the input source selected for each audio channel and other audio-related settings.

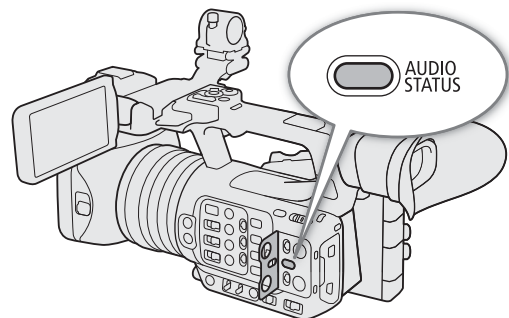

Audio Format for MP4 Clips

Select the audio recording format for MP4 clips (primary clips or sub recording clips).

Select **MENU** > [Recording/Media Setup] > [Main Audio Format (MP4)] or [Audio Format (MP4)] > Desired option.

Recording Audio Using the Second Card Recording Functions

You can record audio in a lighter format as a WAV file by using the second card recording functions. The main clip's 4-channel audio is converted into 1-channel audio at a lower audio quality.

- 1 Insert an SD card into both card slots (A for the main clip, B for the audio file).
- 2 Select **MENU** > [Recording/Media Setup] > [Recording Mode] > [Normal Recording].
- 3 Select **MENU** > [Recording/Media Setup] > [2nd Card Rec Functions] > [Main / Audio Rec].
- 4 Press the REC button to start recording.
 - The main clip and the WAV file will be recorded simultaneously.

i NOTES

- About audio recorded using the second card recording functions.
 - Audio is recorded with the following settings: 8 kHz, 16 bit, 1 channel.
 - If video cannot be recorded due to a card problem, audio will also not be recorded.
 - However, video will be recorded even if audio cannot be recorded due to a card problem.
 - Audio will not be recorded if there is an existing WAV file with the same file name.
 - Audio recording will stop automatically once it reaches 6 hours (video recording will continue).
 - A maximum of 999 WAV files can be recorded.

Connecting an External Microphone or External Audio Input Source to the Camera

To each of the INPUT terminals you can attach commercially available microphones or analog line in sources with an XLR connector. To the MIC terminal you can attach commercially available condenser microphones with a Ø 3.5 mm stereo mini plug/external line input device (analog). Using the supplied microphone holder, you can fix external microphones with a diameter of 19 mm to 20 mm.

- 1 To use a microphone, loosen the microphone lock screw (1), open the microphone holder and insert the microphone (2).
- 2 Tighten the lock screw (3) and put the microphone cable through the cable clamp.
- 3 When using any INPUT terminal, set the corresponding INPUT 1/INPUT 2 (audio source selection) switch to a position other than MIC+48V (4).
- 4 Plug the microphone/external line-in device cable into the desired INPUT terminal (5) or the MIC terminal (6).

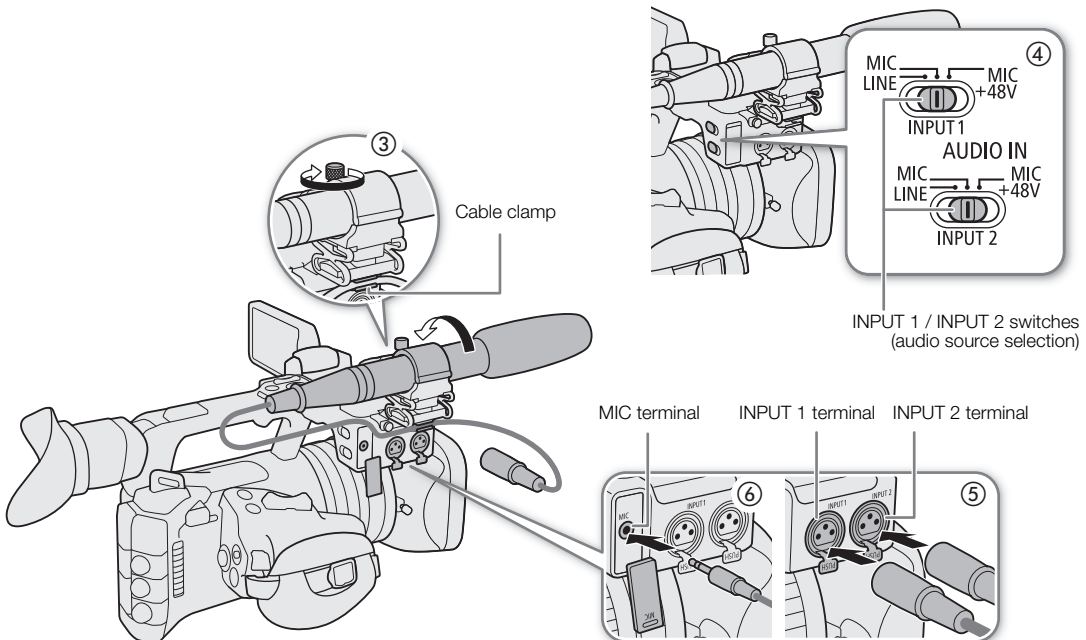
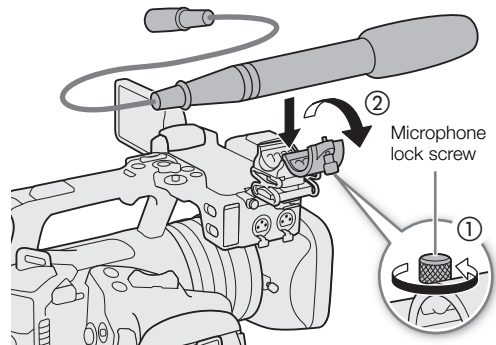

! IMPORTANT

- Do not connect or disconnect microphones and other audio devices from any INPUT terminal when the corresponding INPUT (audio source selection) switch is set to the MIC+48V position. This may damage the camera and/or device.

Selecting the Input Type for the INPUT 1/INPUT 2 Terminals

Change the position of the corresponding INPUT (audio source selection) switch according to the audio device connected to the INPUT 1/INPUT 2 terminals.

Set the INPUT 1 or INPUT 2 switch to LINE, MIC, or MIC+48V.

- When using the INPUT terminals to record to only one channel, use the INPUT 1 terminal.

! IMPORTANT

- When using a microphone that requires phantom power, turn off the camera and set the respective INPUT switch to MIC. After connecting a +48V compatible microphone, switch the INPUT switch to MIC+48V.
- Do not connect or disconnect microphones and other audio devices from any INPUT terminal when the corresponding INPUT (audio source selection) switch is set to the MIC+48V position. This may damage the camera and/or device.

Selecting the Input Type for the MIC Terminal

Change the setting according to the audio device connected to the MIC terminal.

- 1 Select **MENU** > [**J**] Audio Setup] > [MIC Input]
- 2 Select [MIC (with Power Supply)], [MIC], or [LINE]
 - Select [MIC (with Power Supply)] to supply plug-in power to the external microphone.

! IMPORTANT

- Connecting an external microphone that does not require power supply when [MIC Input] is set to [MIC (with Power Supply)], may damage the microphone.

Selecting the Audio Input Source for Audio Channels

You can select the audio input source that will be recorded on CH1/CH2 or CH3/CH4, independently for each pair of audio channels. For details refer to the *Audio Settings and Recorded Audio Channels* table (📖 94).

- 1 Select **MENU** > [**J**] Audio Setup] > [Audio Input Selection] > [CH1/CH2].
- 2 Select [INPUT Terminals], [MIC Terminal] or [Built-in Mic].
- 3 Select the audio input for [CH3/CH4], in the same way.
 - When a commercially available accessory compatible with the multi-function shoe is attached, choose from [INPUT Terminals (Camera)], [MIC Terminal], [Built-in Mic] or [Multi-Function Shoe].
- 4 Press CANCEL to return to the previous screen.

Recording the Same Analog Audio Input to Two Channels

If you set the audio input source to [INPUT Terminals], by default, each audio input is recorded to a separate audio channel (INPUT 1 to CH1 and INPUT 2 to CH2).

If necessary audio from the INPUT 1 terminal can be recorded on both CH1 and CH2 (CH2 as backup). In that case, you can adjust the audio recording levels of each channel independently of each other. It is also possible to record audio to CH2 from the MIC terminal or the built-in microphone.

Select **MENU** > [**J**] Audio Setup > [CH2 Input] > Desired option.

Options

- [INPUT 2]: Records audio to each channel separately. Audio input into INPUT 1 is recorded to CH1, while audio input into INPUT 2 is recorded to CH2.
- [INPUT 1]: Audio input into INPUT 1 is recorded to both channels. Audio input into INPUT 2 will not be recorded.
- [MIC Terminal]: Records audio to each channel separately.* Audio input into INPUT 1 is recorded to CH1, while audio input into the MIC terminal is recorded to CH2.
- [Built-in Mic]: Records audio to each channel separately.* Audio input into INPUT 1 is recorded to CH1, while audio input into the built-in microphone is recorded to CH2.

* Audio is recorded as L+R.

Adjusting the Audio Recording Level

You can adjust the audio recording level of the INPUT terminals, MIC terminal or the built-in microphone. You can select automatic or manual audio level adjustment, and adjust each audio channel separately or adjust CH1/CH2 or CH3/CH4 together (when the audio level adjustment of the audio channels is linked, 99). For the built-in microphone, the adjustments of CH1 apply to both CH1/CH2.

Automatic Audio Level Adjustment for CH1, CH2 or CH1/CH2

Set the audio level switch of the desired channel to A (automatic) to let the camera automatically adjust that channel's audio level.

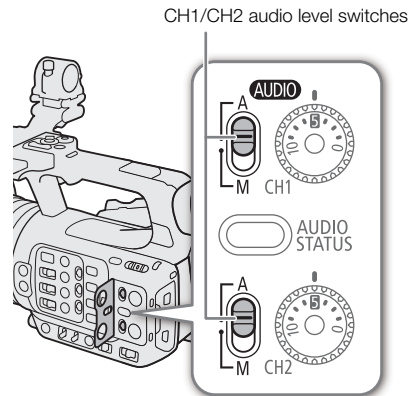

Manual Audio Level Adjustment for CH1, CH2 or CH1/CH2

You can set the audio level manually from $-\infty$ to +18 dB.

- 1 Set the audio level switch of the desired channel to M (manual).
- 2 Turn the corresponding audio level dial to adjust the audio level.
 - For reference, the 0 corresponds to $-\infty$, 5 corresponds to 0 dB, and 10 corresponds to +18 dB.
 - As a guideline, adjust the audio recording level so that the audio level meter on the screen will go to the right of the -18 dB mark (one mark right of the -20 dB mark) only occasionally.

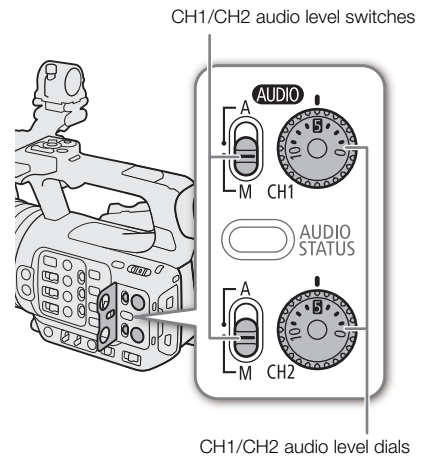

Audio Level Adjustment for CH3, CH4 or CH3/CH4

- 1 Select **MENU** > [Audio Setup] > [Audio Rec Level CH3], [Audio Rec Level CH4] or [Audio Rec Level CH3/CH4] > [Automatic] or [Manual].
 - If you selected [Automatic], the rest of the procedure is not necessary. If you selected [Manual], continue the procedure to set the audio recording level.
- 2 Select **MENU** > [Audio Setup] > [CH3 Level], [CH4 Level] or [CH3/CH4 Level] > Adjust the audio level as needed.
 - For reference, 0 corresponds to $-\infty$, 50 corresponds to 0 dB, and 100 corresponds to +18 dB.
 - As a guideline, adjust the audio recording level so that the audio level meter on the screen will go to the right of the -18 dB mark (one mark right of the -20 dB mark) only occasionally.

Automatic Level Control (ALC): Linking the audio level adjustment of CH1/CH2 or CH3/CH4

- When both CH1 and CH2 are set to the MIC terminal or INPUT terminals and to the same type of analog audio source (external line input or external microphone), you can use the **MENU** > [Audio Setup] > [CH1/CH2 ALC Link] or [CH3/CH4 ALC Link] setting to link the audio level adjustment of both channels.
- When linked, different channels can be adjusted together. Adjust the CH1 audio levels to affect both CH1 and CH2 or adjust the CH3 audio levels to affect both CH3 and CH4.

Audio peak limiter

- You can set **MENU** > [Audio Setup] > [INPUT Limiter] to [On] to activate the audio limiter to limit the amplitude of audio input signals when they start to distort.

NOTES

- We recommend using headphones when adjusting the audio level. If the input level is too high, audio may become distorted even if the audio level indicator shows an appropriate level.
- If you set an assignable button to [Audio Level Indicator] (119), you can press the button to turn the onscreen audio level indicator on and off.

Advanced Audio Input Settings

You can adjust the audio input settings for the INPUT terminals, MIC terminal, and the built-in microphone. The corresponding menu settings become available only when the respective audio input is active and the following conditions are met:

INPUT terminals: INPUT 1 or INPUT 2 switch is set to MIC or MIC+48V

MIC terminal: [MIC Input] is set to [MIC] or [MIC (with Power Supply)]

Microphone Sensitivity (INPUT Terminals)

You can select the external microphone's sensitivity.

Select **MENU** > [**J**] Audio Setup > [INPUT 1 Mic Trimming] or [INPUT 2 Mic Trimming] > Desired sensitivity level.

- You can select one of 5 sensitivity levels from -12 dB to +12 dB.

Microphone Attenuator (INPUT Terminals)

You can activate the external microphone's attenuator (20 dB).

Select **MENU** > [**J**] Audio Setup > [INPUT 1 Mic Att.] or [INPUT 2 Mic Att.] > [On].

External Microphone Characteristics (INPUT Terminals)

Select **MENU** > [**J**] Audio Setup > [INPUT 1 Mic Low Cut] or [INPUT 2 Mic Low Cut] > Desired option.

Options

[Off]: For recording audio under usual conditions.

[LC1]: For recording mainly people's voices.

[LC2]: For reducing the background sound of wind when recording outdoors in windy surroundings (for example, on a beach or close to buildings). Note that when you use this setting some low-frequency sounds may be suppressed along with the sound of wind.

Changing the Reference Level of the External Microphone (INPUT Terminals)

You can select the reference level of each INPUT terminal (-18 dB or -20 dB).

Select **MENU** > [**J**] Audio Setup > [INPUT Reference Level] > Desired option.

Built-in Microphone Sensitivity

You can adjust the sensitivity according as necessary.

Select **MENU** > [**J**] Audio Setup > [Built-in Mic Sensitivity] > Desired option.

Options

[Normal]: For recording audio under usual conditions.

[High]: For recording audio at a higher volume (+6 dB).

Microphone Attenuator (MIC Terminal/Built-in Microphone)

You can activate the microphone attenuator for an external microphone or the built-in microphone (20 dB).

Select **MENU** > [**J**] Audio Setup > [MIC Att.] or [Built-in Mic Att.] > [On].

Microphone Characteristics (MIC Terminal/Built-In Microphone)

You can choose the microphone characteristics as necessary.

Select **MENU** > [🎵] Audio Setup] > [MIC Low Cut] or [Built-in Mic Low Cut] > Desired option.

Options

- [Off]: For recording audio under usual conditions.
- [LC1]: For recording mainly people's voices.
- [LC2]: For reducing the background sound of wind when recording outdoors in windy surroundings (for example, on a beach or close to buildings). Note that when you use this setting some low-frequency sounds may be suppressed along with the sound of wind.

Monitoring the Audio with Headphones

Connect headphones with a \varnothing 3.5 mm stereo mini-plug to the 🎧 (headphone) terminal to monitor the recorded audio.

📘 NOTES

- You can adjust the headphone volume with the **MENU** > [🎵] Audio Setup] > [Headphone Volume] setting. If you set an assignable button to [Headphones +] or [Headphones -] (📖 119), you can press the button to adjust the headphone volume without using the menu.

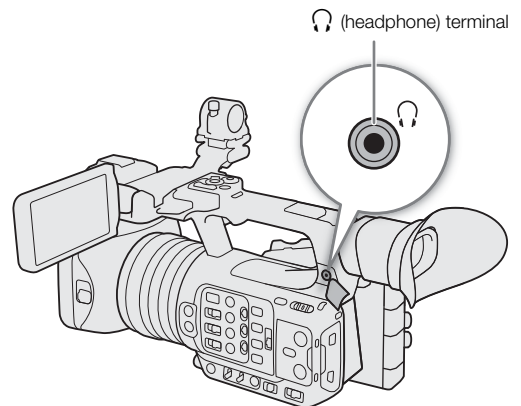

Colors Bars/Audio Reference Signal

You can have the camera generate color bars and a 1 kHz audio reference signal and output them from the following terminals.

	LCD monitor	Viewfinder	SDI OUT terminal	HDMI OUT terminal	🎧 (headphone) terminal
Color bars	●	●	●	●	-
Audio reference signal	-	-	●	●	●

Color Bars

The camera offers SMPTE, EBU and ARIB color bars.

1 Select **MENU** > [📺 Camera Setup] > [Color Bars] > [On].

- The selected color bars appear on the screen.

2 Select **MENU** > [📺 Camera Setup] > [Color Bar Type] > Desired option.

- The selected color bars will be recorded when you press the REC button.
- Turning off the camera or changing the operating mode to MEDIA mode will deactivate the color bars.

NOTES

- If you set an assignable button to [Color Bars] (📖 119), you can press the button to turn the color bars on/off.

Color bars cannot be displayed in the following cases:

- When slow & fast motion recording is activated.
- When the gamma curve component of the [Gamma/Color Space] setting in the custom picture is set to an option other than [BT.709 Wide DR], [BT.709 Normal], [BT.709 Standard] or [Canon 709].

Audio Reference Signal

The camera can output a 1 kHz audio reference signal with the color bars.

Select **MENU** > [🔊 Audio Setup] > [1 kHz Tone] > Desired option.

- You can select one of three audio levels (-12 dB, -18 dB, -20 dB), or [Off] to turn off the signal.
- The reference signal will be output at the selected level when you display the color bars, and will be recorded when you press the REC button.

Video Scopes

The camera can display a simplified waveform monitor or a vectorscope to check your recordings. The selected video scope is displayed on the screen and can be output to other monitoring devices as well.

Displaying a Video Scope

Choose between a waveform monitor or a vectorscope. You can also change opacity, position and waveform monitor size settings.

1 Select **MENU** > [Assistance Functions] > [WFM Function] > [Waveform Monitor] or [Vectorscope].

2 Press the WFM button.

- Alternatively, you can use one of the **MENU** > [Assistance Functions] > [WFM:] settings to turn the video scope on/off separately on the desired video output.
- By default, the video scope will appear on the right of the screen. Using the **MENU** > [Assistance Functions] > [Waveform Settings] or [Vectorscope Settings] > [Position] settings, you can select where to display it (left or right side).
- You can also use direct touch control (50) to turn on/off the display of video scopes, or to change their position.

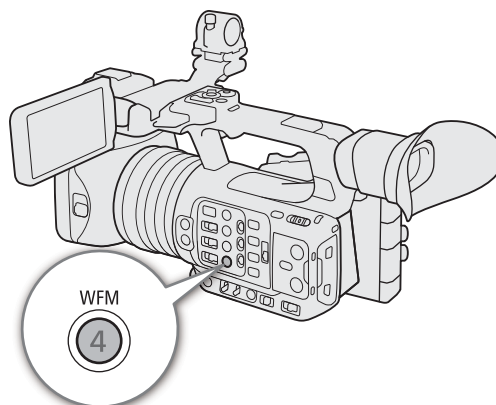

3 If needed, select **MENU** > [Assistance Functions] > [WFM Opacity Level] > Desired option.

- The smaller the percentage the more transparent the onscreen displays.

i NOTES

- The video scopes will also be displayed while adjusting a custom picture file's image settings (125).
- Applying a LUT, view assistance, or range to video on the LCD screen, viewfinder, SDI OUT terminal or HDMI OUT terminal does not affect the waveform function.
- When **MENU** > [System Setup] > [SDI Output Signal] is set to [720x480i] or [720x576i], you cannot output a waveform monitor/vectorscope from the SDI OUT terminal.

Changing the Waveform Monitor Settings

1 Select **MENU** > [Assistance Functions] > [Waveform Settings] > [Type] > Desired option.

- If you selected an option other than [Select Line], skip to step 4.

2 Select **MENU** > [Assistance Functions] > [Waveform Settings] > [Select Line].

3 Enter the Y coordinate of the red horizontal line to display using the data entry screen (27).

- The available range of lines that can be selected depends on the vertical component of the resolution used.
For 2160: 0 to 2158 (in 2-line increments)
For 1080: 0 to 1079 (in 1-line increments)
For 720: 0 to 719 (in 1-line increments)

4 Select **MENU** > [Assistance Functions] > [Waveform Settings] > [Vertical Scale for HDR] > Desired option.

- Select the Y axis (luminance) scale used when displaying the waveform monitor of an HDR image.

5 Select **MENU** > [Assistance Functions] > [Waveform Settings] > [Gain] > [1x] or [2x].

- If you selected [1x], the rest of the procedure is not necessary.

6 Select **MENU** > [Assistance Functions] > [Waveform Settings] > [Y Position] > Desired option.

- The display range of the waveform monitor's Y axis will be reduced by half. Select the minimum luminance value (in %) shown on the Y axis.

7 If needed, touch the waveform monitor on the screen to change its display size (only for LCD/VF).

- You can also select **MENU** > [Assistance Functions] > [Waveform Settings] > [Size: LCD/VF] > Desired option.

Options for [Type]

[Line]: Sets the waveform monitor to line display mode.

[Line+Spot]: The waveform of the area in the red frame is displayed in red on top of the [Line] mode waveform.

[Select Line]: The selected horizontal line (in red) will be displayed along with its waveform.

[RGB]: Shows 3 side-by-side waveforms in an RGB parade.

[YPbPr]: Shows 3 side-by-side waveforms in a YPbPr parade.

Options for [Vertical Scale for HDR]

[IRE]: Displays the video scope in IRE units.

[PQ/HLG]: For HDR-PQ images, displays the video scope in nits (cd/m^2) and the narrow range's (video range) waveform monitor.
For HDR-HLG images, the Y axis shows a relative-index value between 0.0 and 1.0.

NOTES

- If the waveform monitor is activated and the **MENU** > [Custom Picture] > [Edit CP File] > [Knee] > [Point] setting is changed, when you display the waveform monitor, a horizontal line will appear indicating the luminance (Y) level* corresponding to the knee point.
* When a Look File registered to the custom picture file is active, the displayed luminance may not be at the correct level.
- When the waveform monitor's Y axis is set to display in IRE units, a level of 10 bit 64 maps to 0 IRE and 10 bit 940 maps to 100 IRE, regardless of the custom picture settings.

Changing the Vectorscope Settings

1 Select **MENU** > [Assistance Functions] > [Vectorscope Settings] > [Type] > Desired option.

2 Touch the onscreen vectorscope to switch its magnification rate between [1x] and [2x].

- You can also select **MENU** > [Assistance Functions] > [Vectorscope Settings] > [Gain] > Desired option.

Options for [Type]

[Normal]: Displays the usual vectorscope.

[Spot]: The color signal of the area in the red frame is displayed in red on top of the [Normal] mode waveform.

Adding Marks to Clips in CAMERA Mode

When the main recording format is set to XF-AVC, while recording, you can add shot marks (S) to flag an important shot or frame. After recording a clip, you can add an OK mark (OK) or check mark (✓) to help you identify particular clips.

You can add and delete marks also in MEDIA mode (📖 143, 143).

Marks cannot be added to proxy clips.

Adding a Shot Mark while Recording

To add a shot mark to a clip while recording, you must set an assignable button to [Add Shot Mark] in advance.

- 1 Set an assignable button to [Add Shot Mark] (📖 119).
- 2 While you are recording, press the assignable button at the beginning of the shot you wish to mark.
 - [Shot Mark] will appear briefly and the shot mark will be added to the current frame of the clip.

NOTES

- Up to 100 shot marks can be added to a single clip.
- There may be up to a 0.5 second delay from when you press the button to when the camera adds the shot mark.
- When a clip contains a shot mark, S will appear next to the clip's thumbnail in the playback index screen.
- When pre-recording is activated, you cannot add a shot mark before the REC button is pressed, or during interval recording or frame recording.

Adding an OK Mark or ✓ Mark to the Last Clip Recorded

OK marks can be used to protect important clips, as clips with an OK mark cannot be deleted with the camera. To add a mark in CAMERA mode, you must set an assignable button to [Add OK Mark] or [Add ✓ Mark] in advance.

- 1 Set an assignable button to [Add OK Mark] or [Add ✓ Mark] (📖 119).
- 2 After recording a clip, press the assignable button.
 - [OK Mark] or [✓ Mark] will appear briefly and the selected clip mark will be added to the clip.

NOTES

- A clip cannot have both an OK mark and a ✓ mark at the same time.
- When a clip has an OK mark or ✓ mark, the respective icon will appear next to the clip's thumbnail in the playback index screen.

Using Metadata

The camera automatically adds metadata to the recorded clips. You can use Canon XF Utility to check and search for specific metadata. You can also add News Metadata to the recorded clips (📖 107).

Metadata components

Metadata	Entering content			Checking content		
	Camera	Canon XF utility	Content Transfer Mobile	Camera	Canon XF utility	Content Transfer Mobile
User Memo: clip title, creator, location and description.	–	● ¹	–	●	●	–
GPS information: altitude, latitude and longitude.	● ²	● ³	–	●	●	–
Information about the recording: scene and take.	●	–	–	● ⁴	●	–
Information about camera settings: shutter speed, ISO speed/gain value, etc.	– ⁵	–	–	●	●	–
Unique Material Identifiers (UMID): country, organization and user codes based on the SMPTE standard.	● (📖 199)	–	–	● ⁴	–	–
News Metadata (📖 107)	–	–	●	●	–	●

¹ User memo files need to be created using the software and saved on an SD card in advance.

² Only when a GP-E2 GPS Receiver is connected to the camera. While recording, GPS information is recorded automatically by the camera.

³ GPS information can only be added to clips already recorded.

⁴ Only in CAMERA mode.

⁵ Recording data is logged automatically by the camera.

Setting a User Memo Created with Canon XF Utility

Before you can add a user memo, you must first install Canon XF Utility (📖 160). Next, create the user memo and then save it to an SD card. Once you insert the SD card in the camera and select the user memo, it will be added to clips you record.

1 Use Canon XF Utility to save a user memo to an SD card.

- For details, refer to *Managing User Memo Profiles* in the Canon XF Utility Instruction Manual.

2 Insert the SD card into the camera's SD card slot B.

3 Select **MENU** > [🔧 Recording/Media Setup] > [Metadata] > [Add XML File] > [On].

4 Select **MENU** > [🔧 Recording/Media Setup] > [Metadata] > [XML File Format] > [User Memo].

5 Select **MENU** > [🔧 Recording/Media Setup] > [Metadata] > [User Memo] > Desired user memo file.

- The **MEMO** icon appears on the left of the screen. (only when [📺 Monitoring Setup] > [Custom Display 2] > [User Memo] is set to [On].)

📘 NOTES

- After you set a user memo, do not remove SD card B while you are recording. If the SD card is removed, the user memo will not be added to the clip.
- You must set the user memo before you start recording for it to be added to the clips. You cannot change the user memo already added to a clip using the camera but you can do so with Canon XF Utility.

Using News Metadata

When recording, you can add News Metadata* to the recorded clips. Using a smartphone, you can check and edit News Metadata files. The most recently set News Metadata will be prioritized and added. See the following table for details on News Metadata settings.

* Refers to a metadata file compliant with the DPP002 Metadata Exchange for News recommendation ver. 1.1.1.

News Metadata	Entering content		Checking content	
	Camera	Content Transfer Mobile	Camera	Content Transfer Mobile
Story Title, Description, Keyword (Tags), Category, Contributor, Source/Originator, Copyright Holder, Restrictions.	–	●	●	●
Genre	–	●	–	●
Language	–	–	–	●

NOTES

- News Metadata files with file names that exceed 64 characters (extension included) cannot be used.

Setting News Metadata saved on an SD card

Before setting News Metadata, create a News Metadata file and save it to an SD card. Once you insert the SD card into the camera, select the News Metadata file and start recording. The News Metadata will be added to the recorded clips.

1 Save the News Metadata file to an SD card.

- News Metadata files should be saved in the "/XMLTAG" folder of the SD card.

2 Insert the SD card into the camera's SD card slot B.

3 Select **MENU** > [Recording/Media Setup] > [Metadata] > [Add XML File] > [On].

4 Select **MENU** > [Recording/Media Setup] > [Metadata] > [XML File Format] > [News Metadata].

5 Select **MENU** > [Recording/Media Setup] > [Metadata] > [News Metadata] > Desired News Metadata file saved to the SD card.

- The selected News Metadata file will be saved to the camera.

NOTES

- You cannot change the News Metadata already added to a clip using the camera but you can do so using a smartphone.

Setting News Metadata edited with the Content Transfer Mobile

Before setting News Metadata, edit the News Metadata file using Content Transfer Mobile. Connect the camera to a smartphone using the Content Transfer Mobile ( 161, 194) to transfer and save News Metadata files from a smartphone to the camera. Once saved to the camera, select the News Metadata to be added to the recorded clips.

1 Smartphone: edit the News Metadata file with the Content Transfer Mobile.

2 Connect the camera to a smartphone (161, 194).

3 Operate the Content Transfer Mobile to transfer the News Metadata file to the camera.

4 Save the News Metadata to the camera.

- News Metadata files transferred from a smartphone will be saved automatically to the camera.

- Automatically, **MENU** > [ Recording/Media Setup] > [Metadata] > [Add XML File] will be set to [On], and [XML File Format] will be set to [News Metadata].
- Only the most recently transferred file can be saved.

Resetting News Metadata

You can reset the News Metadata added to clips.



- 1 Select **MENU** > [ Recording/Media Setup] > [Metadata] > [News Metadata Reset All].
- 2 Select [OK].

IMPORTANT

- When the camera is turned off normally, the News Metadata file is saved or a previously saved News Metadata is reset. In the case of a power outage or if the power is not terminated normally the file will not be saved or reset.
- News Metadata saved to the camera will be reset if you select **MENU** > [ System Setup] > [Reset] > [All Settings], or if the camera's firmware is updated.

Entering Slate Information About the Recording

You can enter scene and take information to help identify the recording later on.

- 1 Select **MENU** > [ Recording/Media Setup] > [Metadata] > [Scene] or [Take] > [Change].
- 2 Enter the desired text using the keyboard screen ( 27).
 - To clear the scene/take information, select [Reset] instead.

Special Recording Modes

The camera features the following special recording modes.

Slow & fast motion recording: This mode allows you to change the shooting frame rate to achieve a slow motion or fast motion effect during playback. Recording audio in WAV format is also possible.

Pre-recording: The camera will start recording a few seconds before you press the REC button. This is especially useful when it is difficult to predict when to start recording.

Frame recording: The camera will record a pre-defined number of frames every time you press the REC button. This mode is suitable for recording stop motion animation.

Interval recording: The camera will automatically record a pre-defined number of frames at a pre-defined interval. This mode is suitable for recording subjects with little movement, such as natural surroundings or plants.

Continuous recording: The camera keeps a continuous recording on the SD card in the second slot (MP4 format only) to avoid any missed shooting opportunities.

Slow & Fast Motion Recording

The camera can record using a progressive frame rate (shooting frame rate) that is different from the playback frame rate. Recording a clip with a shooting frame rate higher than the [Frame Rate] setting will result in a slow motion effect during playback. Conversely, a lower shooting frame rate will result in a fast motion effect.

Sound is not recorded with the clip, but it can be recorded separately as a WAV file. The maximum recording time of a single clip is the equivalent of approximately 6 hours of playback time.

You can also use direct touch control to perform this function (☞ 50).

Available shooting frame rates

Main recording format ¹	Main resolution ²	Bit rate	Available shooting frame rate	
XF-AVC	3840x2160 Intra-frame	410Mbps	●	
			Frame rate	Shooting frame rate (slow & fast motion recording)
			29.97P	1, 2, 3, 6, 15, 22, 24, 26, 28, 30
			25.00P	1, 5, 15, 17, 19, 21, 23, 25, 26, 28, 30
	23.98P		1, 2, 3, 6, 12, 16, 18, 20, 22, 24, 26, 28, 30	

¹ MENU > [] Recording/Media Setup > [Main Rec Format].

² MENU > [] Recording/Media Setup > [Main Resolution].



Main recording format ¹	Main resolution ²	Available shooting frame rate	
XF-AVC	3840x2160 Intra-frame ³	●	-
	3840x2160 Long GOP	●	-
	1920x1080 Intra-frame	●	-
	1920x1080 Long GOP	●	●
MP4	3840x2160	●	-
	1920x1080	●	●
Frame rate	Shooting frame rate (slow & fast motion recording)		
59.94P	1, 2, 3, 6, 15, 30, 44, 48, 52, 56, 60	90, 120	
50.00P	1, 5, 15, 25, 34, 38, 42, 46, 50, 54, 58, 60	75, 100, 120	
29.97P	1, 2, 3, 6, 15, 22, 24, 26, 28, 30, 32, 36, 40, 44, 48, 52, 56, 60	90, 120	
25.00P	1, 5, 15, 17, 19, 21, 23, 25, 26, 28, 30, 34, 38, 42, 46, 50, 54, 58, 60	75, 100, 120	

Frame rate	Shooting frame rate (slow & fast motion recording)	
23.98P	1, 2, 3, 6, 12, 16, 18, 20, 22, 24, 26, 28, 30, 32, 36, 40, 44, 48, 52, 56, 60	72, 96, 120

¹ **MENU** > [ Recording/Media Setup] > [Main Rec Format].

² **MENU** > [ Recording/Media Setup] > [Main Resolution]

³ When the bit rate is other than 410 Mbps.

- 1 To record audio, insert an SD card into the card slot where video is not being recorded.
- 2 Select **MENU** > [ Recording/Media Setup] > [Recording Mode] > [Slow & Fast Motion] or [S&F Clip/Audio (WAV)].
 - Slow & fast motion recording is activated. [S&F STBY] appears on the screen and the shooting frame rate appears next to the frame rate setting (the playback frame rate).
- 3 Select **MENU** > [ Recording/Media Setup] > [Slow & Fast Frame Rate] > Desired frame rate.
 - You can also choose a preset value (half, same or double the playback frame rate).
- 4 Press the REC button to begin recording.
 - The tally lamp illuminates.
 - [S&F STBY] changes to [S&F ●REC] while recording.
- 5 Press the REC button again to stop recording.
 - The clip is recorded on the selected SD card.
 - When [S&F Clip/Audio (WAV)] is selected, the WAV file will be recorded on the SD card where video is not being recorded.
 - The tally lamp goes out and the onscreen display changes back to [S&F STBY].
- 6 Select **MENU** > [ Recording/Media Setup] > [Recording Mode] > [Normal Recording] to turn off slow & fast motion recording.

NOTES

- The shooting frame rate cannot be changed while recording.
- If you change the system frequency, slow & fast motion recording will be canceled and the shooting frame rate will be reset to its default value.
- **About the time code when slow & fast motion recording is activated:**
 - The time code mode can be set to [Regen.], or to [Preset] with [Rec Run] running mode.
 - If the time code running mode was set to [Free Run], the time code running mode will be changed automatically to [Rec Run] when slow & fast motion recording is activated.
 - When the special recording mode is turned off, the time code running mode will return to its previous setting.
 - The time code signal will not be output from any terminal.
- **Recording WAV files**
 - Audio is recorded with the following settings: 48 kHz, 24 bit, 4 channels.
 - If video cannot be recorded due to a card problem, audio will also not be recorded.
 - However, video will be recorded even if audio cannot be recorded due to a card problem.
 - Audio will not be recorded if there is an existing WAV file with the same file name.
 - Audio recording will stop automatically after reaching 60 minutes (video recording will continue).
 - A maximum of 999 WAV files can be recorded.

Pre-recording

When pre-recording is activated, the camera starts recording continuously onto a temporary memory (approx. 3 seconds) so when you press the REC button, the clip will contain also a few seconds of video and audio recorded before you pressed the button.

You can also use direct touch control to perform this function (📖 50).

- 1 Select **MENU** > [📷 Recording/Media Setup] > [Recording Mode] > [Pre-Recording].
 - [PRE STBY] appears on the screen.
- 2 Press the REC button to begin recording.
 - The tally lamp illuminates.
 - [PRE STBY] changes to [PRE ● REC] while recording.
- 3 Press the REC button again to stop recording.
 - The clip is recorded. The recorded clip will include a few seconds of video and audio recorded before the REC button was pressed.
 - The tally lamp goes out and the onscreen display changes back to [PRE STBY].
- 4 Select **MENU** > [📷 Recording/Media Setup] > [Recording Mode] > [Normal Recording] to stop pre-recording.

NOTES

- Pre-recording will be canceled if the recording mode is changed.
- **About the time code when pre-recording is activated:**
 - The time code of the clip will start a few seconds before the REC button was pressed.
 - The time code will be recorded with the running mode set to [Free Run].
 - If the time code mode was set to [Regen.], or to [Preset] with [Rec Run] running mode, the time code running mode will be changed automatically to [Free Run] when pre-recording is activated.
 - When the special recording mode is turned off, the time code running mode will return to its previous setting.

Frame Recording Mode

Set the number of frames in advance. We recommend operating the camera remotely or stabilizing the camera, for example, on a tripod. Sound is not recorded in this mode.

You can also use direct touch control to perform this function (📖 50).

- 1 Select > [📷 Recording/Media Setup] > [Recording Mode] > [Frame Recording].
 - [FRM STBY] appears on the screen (with [FRM] flashing).
- 2 Select > [📷 Recording/Media Setup] > [Frame Rec: Frame Rate] > Desired option.
- 3 Press the REC button to begin recording.
 - The tally lamp illuminates.
 - [FRM STBY] changes to [FRM ● REC] while recording.
 - The camera automatically records the specified number of frames.
- 4 Repeat until you finish recording.
- 5 Select > [📷 Recording/Media Setup] > [Recording Mode] > [Normal Recording] to stop frame recording.
 - Frame recording mode ends and all of the recorded frames are joined together into one clip.
 - The tally lamp goes out and [STBY] appears on the screen.

i NOTES

- Frame recording cannot be used when the frame rate is set to 59.94i or 50.00i. When in use, frame recording will end if the frame rate is set to 59.94i or 50.00i.
- The number of frames recorded cannot be changed while recording.
- Some frames at the point the recording was stopped may be recorded and added to the end of the clip.
- **About the time code when frame recording is activated:**
 - The time code mode can be set to [Regen.], or to [Preset] with [Rec Run] running mode. The time code advances by the number of frames recorded every time.
 - If the time code running mode was set to [Free Run] or the camera was synchronized to an external time code signal, the time code running mode will be changed automatically to [Rec Run] when frame recording is activated.
 - When the special recording mode is deactivated, the time code running mode will return to its previous setting.
 - The time code signal will not be output from the TIME CODE terminal, SDI OUT terminal or HDMI OUT terminal.

Interval Recording Mode

Set the interval and number of frames in advance. Sound is not recorded in this mode. You can also use direct touch control to perform this function (📖 50).

- 1 Select > [🔧 Recording/Media Setup] > [Recording Mode] > [Interval Recording].
 - [INT STBY] appears at the top of the screen (with [INT] flashing).
- 2 Select > [🔧 Recording/Media Setup] > [Interval Rec: Time Interval] > Desired option.
- 3 Select > [🔧 Recording/Media Setup] > [Interval Rec: Frame Rate] > Desired option.
- 4 Press the REC button to begin recording.
 - The tally lamp illuminates.
 - [INT STBY] changes to [INT ● REC] while recording.
 - The camera automatically records the set number of frames at the specified interval.
- 5 Press the REC button again to stop recording.
 - The tally lamp goes out and [INT STBY] appears at the top of the screen (with [INT] flashing).
- 6 Select > [🔧 Recording/Media Setup] > [Recording Mode] > [Normal Recording] to stop interval recording.

i NOTES

- Interval recording cannot be used when the frame rate is set to 59.94i or 50.00i. When in use, interval recording will end if the frame rate is set to 59.94i or 50.00i.
- The interval and the number of frames recorded cannot be changed while recording.
- Some frames at the point the recording was stopped may be recorded and added to the end of the clip.
- **About the time code when interval recording is activated:**
 - The time code mode can be set to [Regen.], or to [Preset] with [Rec Run] running mode. The time code advances by the number of frames recorded every time.
 - If the time code running mode was set to [Free Run] or the camera was synchronized to an external time code signal, the time code running mode will be changed automatically to [Rec Run] when interval recording is activated.
 - When the special recording mode is deactivated, the time code running mode will return to its previous setting.

- The time code signal will not be output from the TIME CODE terminal, SDI OUT terminal or HDMI OUT terminal.

Continuous Recording

Audio and video are recorded on both cards in this mode, normal recording on SD card A, and continuous recording on SD card B. This function can be used when the main recording format is set to MP4. Video will be recorded in MP4 format and audio will be recorded in linear PCM format.

With the exception of step 5, you can also use direct touch control to perform this function (📖 50).

- 1 Insert an SD card into each card slot (slot A for normal recording, slot B for continuous recording).
- 2 Select **MENU** > [🔧 Recording/Media Setup] > [Recording Mode] > [A]Main / [B]Continuous Rec].
 - The continuous recording mode is activated and [CONT] appears on the screen next to the SD card B indicator.
- 3 Select **MENU** > [🔧 Recording/Media Setup] > [Continuous Recording] > [REC].
 - The tally lamp illuminates and continuous recording starts on SD card B. The onscreen display changes to [●CONT].
- 4 Press the REC button to start recording.
 - Normal recording on SD card A starts.
 - If you press the button before step 3, recording will start on both cards.
- 5 Select **MENU** > [🔧 Recording/Media Setup] > [Continuous Recording] > [STBY].
 - The tally lamp goes out and recording stops on both cards. The onscreen display changes to [CONT].
- 6 Select **MENU** > [🔧 Recording/Media Setup] > [Recording Mode] > [Normal Recording] to turn off continuous recording.

NOTES

- When continuous recording is activated, if recording on SD card B (continuous recording) is not available, normal recording on SD card A will not be possible either.
- Continuous recording will continue even if SD card A becomes full.
- If [Continuous Recording] is set to [STBY] and the main recording format is changed to an option other than MP4, continuous recording will be canceled.

Infrared Recording

You can use the infrared mode to record in very dark situations using available infrared light. You can also use the camera's infrared light to make the recordings even brighter, and select the color for the picture (white or green).

1 Set the INFRARED switch to ON.

- **IR** and **OFF** appear on the screen.

2 **MENU** > [**Camera Setup**] > [IR Rec Color] > Desired option.

3 To turn on the infrared light, select **MENU** > [**Camera Setup**] > [IR Light] > Desired option.

- When the infrared light is on, **OFF** changes to **ON**.

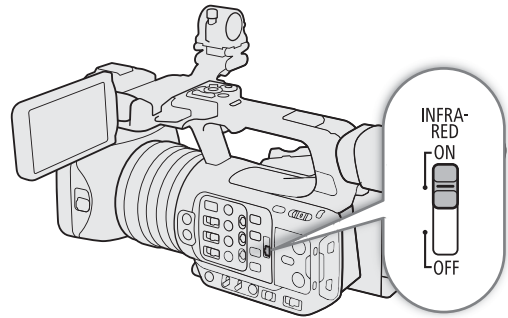

Options

[Toggle]: Allows you to turn the infrared light on and off using an assignable button. Set an assignable button (☰ 119) to [IR Light] in advance and press the assignable button to turn the infrared light on/off.

[Always On]: The infrared light is always on while the camera is in infrared mode.

[Always Off]: The infrared light is always off.

! IMPORTANT

- Depending on usage, recording in infrared mode may constitute an infringement of privacy and publicity rights, as well as a violation of laws or ordinances.

i NOTES

- When infrared recording is activated, the following changes take place.
 - The camera switches to automatic gain and shutter speed adjustment, the aperture is fixed at maximum aperture, and the ND filter is retracted and cannot be used. Also, [AE Response] operation will be [Normal] regardless of the setting.
 - The limit for auto mode, light metering, AE shift and white balance settings cannot be used.
 - When the camera switches to infrared mode, the autofocus may be activated momentarily and the focus point may change. Check that the focus is correct.
- Depending on the light source, autofocus may not work well while zooming.
- In infrared mode the camera's sensor is considerably more sensitive to near-infrared light. Do not point the lens at strong light or heat sources when infrared recording is activated. If there are such light/heat sources in the picture, we recommend shielding the lens before switching the camera to infrared mode.
- If you set an assignable button to [IR Rec Color] (☰ 119), you can press the button to change the color of the recorded picture.
- When using **MENU** > [**Camera Setup**] > [IR Slow Shutter], set **MENU** > [**Monitoring Setup**] > [Run VF at x2 Speed] to [Off].

Using the RC-V100 Remote Controller

You can connect the RC-V100 Remote Controller to the camera in order to control the camera (including advanced recording functions) from a distance. The remote controller lets you turn the camera on, navigate the menus and remotely control the aperture and shutter speed, change picture-related settings like the knee and sharpness, and more.

For details on how to connect and use the remote controller, refer to its instruction manual.

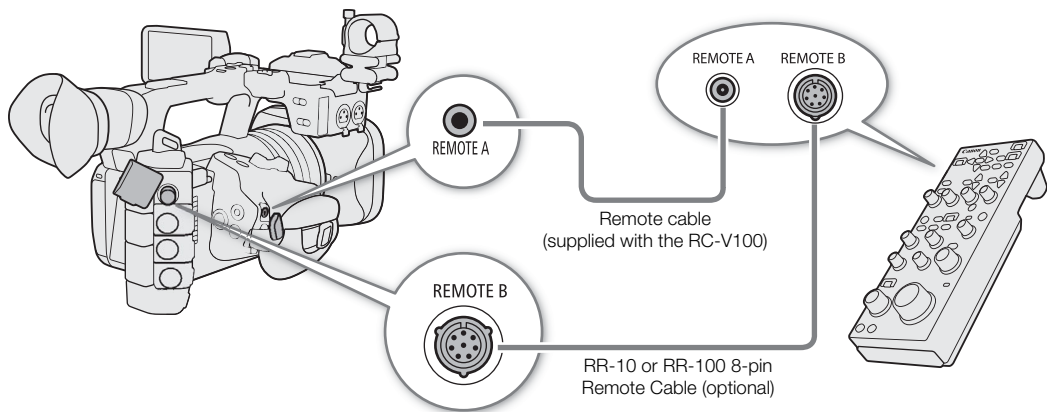

- 1 Turn off the camera and connect the RC-V100 Remote Controller to the camera.
- 2 Turn on the camera in CAMERA mode.
- 3 Select **MENU** > [🔧 System Setup] > [REMOTE Term.] > [RC-V100 (REMOTE A)] or [RC-V100 (REMOTE B)].

Options

[RC-V100 (REMOTE A)]:

Select this option to use the optional RC-V100 connected to the camera with the RC-V100's remote cable.

[RC-V100 (REMOTE B)]:

Select this option to use the RC-V100 connected to an expansion unit with an 8-pin remote cable (all optionals).

[Standard]:

Select this option to use commercially available remote controls.

[Standard + RC-V100]:

Select this option to use a commercially available remote control (connected to the REMOTE A terminal) simultaneously with an optional RC-V100 (connected to the REMOTE B terminal).

i NOTES

- When the camera is set to full auto mode (📷 42), settings related to the aperture, gain, shutter speed and white balance (except for [R Gain] and [B Gain] in the custom picture's [White Balance] settings*) cannot be changed using the remote controller.

* When infrared recording is activated, even the WHITE BALANCE R and B dials will have no effect on the camera.

Recording Remotely Using an NU Protocol Compatible Device

You can connect a device compatible with the NU Protocol to the camera in order to control the camera from a distance.

116

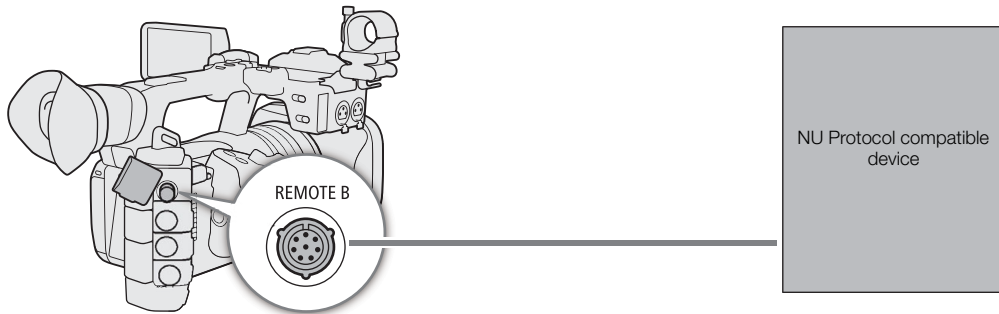

- 1 Turn off the camera and connect the NU Protocol compatible device to the camera.
- 2 Turn on the camera in CAMERA mode.
- 3 Select **MENU** > [**⚙** System Setup] > [REMOTE Term.] > [NU Protocol (REMOTE B)]

Web Camera Function

You can connect the camera to a computer using a USB cable, and use the camera as a web camera (with compatible software). Only video can be recorded while using this function. For more details about supported operative systems or software tested for use with the camera, visit your local Canon website. For more details, refer to the computer's and the USB cable's instruction manuals.

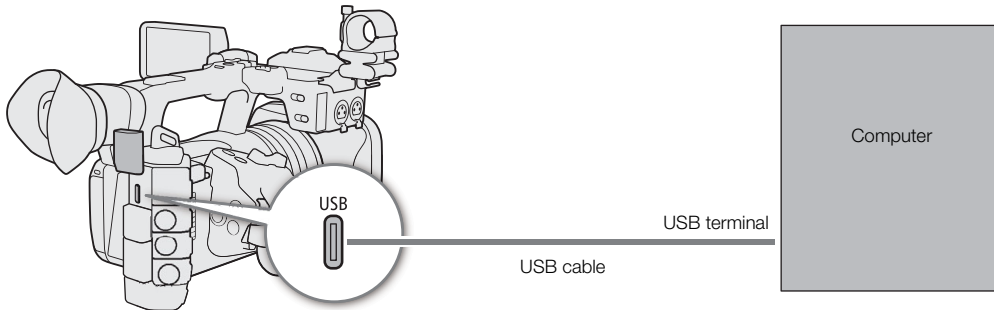

Video output configuration

Video format	Resolution	Frame rate
Motion JPEG	1024x576	30 fps (maximum)

- 1 Select **MENU** > [🔧 System Setup] > [USB (Type-C) Mode] > [Video Output (UVC)].
- 2 Connect the camera to a computer.
- 3 Open the desired compatible software on the computer.
- 4 When the connection ends, disconnect the USB cable from the camera.

i NOTES

- This function cannot be used simultaneously with the Browser Remote function (📖 184), XC Protocol (📖 191), still image recording or during IP streaming.

Assignable Buttons

The camera offers a number of assignable buttons to which you can assign various function. Assign often-used functions to the buttons you find most convenient to personalize the camera to your needs and preferences. You can find 11 assignable buttons on the camera's body, and 4 assignable buttons on the RC-V100 Remote Controller, RC-IP100/RC-IP1000 Remote Camera Controller, Browser Remote, Remote Camera Control Application and Multi-Camera Control. In most cases, the names of the buttons printed on the camera and accessories also indicate their default settings.

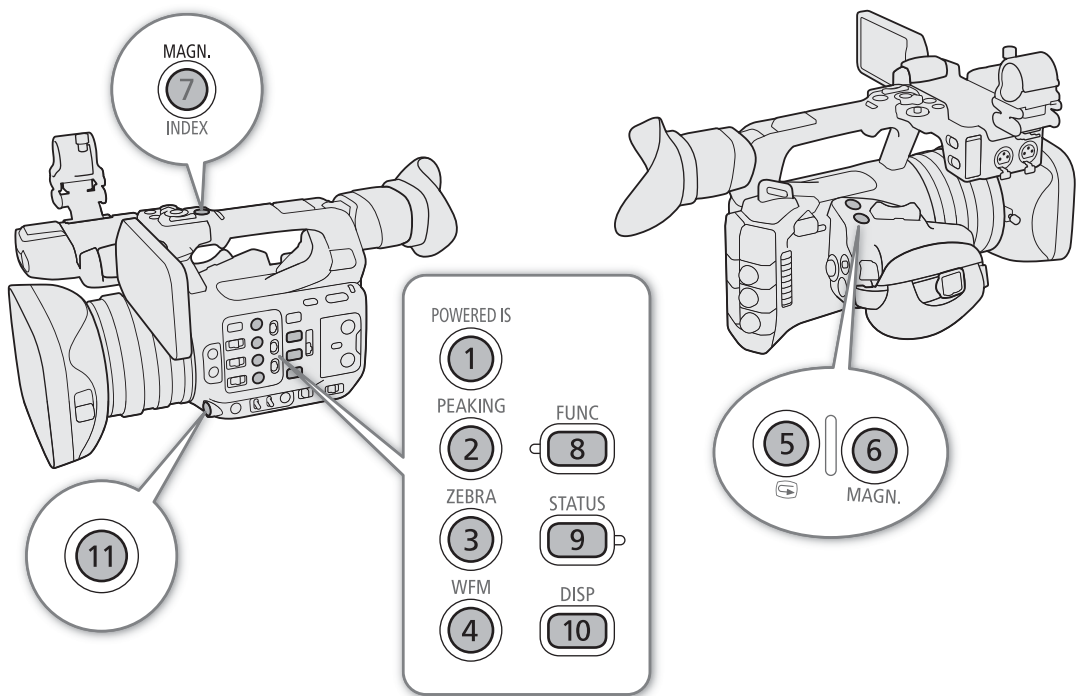

Changing the Assigned Function

Functions can be set separately in CAMERA mode and MEDIA mode.

- 1 Press the MENU button and, while holding it pressed down, press the assignable button whose function you wish to change.
 - A list of available functions appears.
 - You can also select the appropriate menu setting from the various pages of the **MENU** > [Assignable Buttons] menu.
- 2 Select the desired function.
 - The selected function will be assigned to the selected button.

3 If you selected [User Setting], select the menu setting you want to register.

- The selected menu setting will be assigned to the selected button. User-selected settings will be indicated with a **MENU** icon in the [Assignable Buttons] menu.

4 Press the assignable button to use the assigned function as described in the following table.







i NOTES

- You can check the [Assignable Buttons] status screens (211) to see what functions are currently assigned to each button.
- You can reset only the functions assigned to the assignable buttons, without affecting other camera settings, with the **MENU** > [System Setup] > [Reset] > [Assignable Buttons] function. All the assignable buttons will return to their default function.
- When you select **MENU** > [Assignable Buttons] > [Link to Camera] > [Enable], the functions assigned to assignable buttons 1–4 on the camera can also be assigned to assignable buttons 1–4 of the RC-V100, RC-IP100/RC-IP1000, Browser Remote, Remote Camera Control Application and Multi-Camera Control.

Assignable functions

Functions whose names include a video output destination (LCD, terminal name) affect only the specified video output, while [All] indicates the function affects all video outputs.

Function name	Description	CAMERA mode	MEDIA mode	
[NONE]	No function assigned – the button is disabled.	●	●	–
[AF Lock] ¹	Turns the AF lock function on/off.	●	–	76
[PUSH AF/MF]	Activates the PUSH AF/MF function while the button is held pressed down.	●	–	79
[AF Frame]	Toggles the size of the AF frame.	●	–	81
[Face Detection AE]	Turns face detection AE on/off.	●	–	81
[Face AF]	Toggles the [Face AF] setting between [Face Priority] and [Face Only].	●	–	81
[Face Det. & Tracking]	Turns the face detection & tracking function on/off.	●	–	81
[Eye Detection]	Turns eye detection on/off.	●	–	–
[Tracking]	Enters/cancels tracking standby mode.	●	–	83
[Focus Guide]	Turns the focus guide on/off.	●	–	77
[Peaking: All], [Peaking: LCD/VF] [Peaking: LCD], [Peaking: VF], [Peaking: SDI], [Peaking: HDMI]	Turns peaking on/off.	●	–	78
[Magnification], [Magn.: LCD], [Magn.: VF], [Magn.: SDI], [Magn.: HDMI]	Turns magnification on/off.	●	–	78
[Digital Zoom]	Turns the 300x digital zoom on/off.	●	–	71
[Tele-converter]	Cycles through the digital tele-converter options in the following order: 6.0x → 3.0x → 1.5x → Off.	●	–	71
[Push Auto Iris]	The camera automatically adjusts the aperture only while the button is held pressed down.	●	–	65
[Iris +], [Iris –]	Opens up/closes the aperture, respectively.	●	–	65
[ND +], [ND –]	Cycles through ND filter settings in increasing (higher density) or decreasing (lower density) order, respectively.	●	–	64

Function name	Description	CAMERA mode	MEDIA mode	
[Gain Boost] ¹	Switches between a gain level of 36.0 dB (gain boost) and the currently set gain level.	●	–	62
[AE Shift +], [AE Shift –]	Compensates the exposure making the image brighter/darker, respectively.	●	–	67
[Backlight], [Spotlight]	Toggles the light metering mode between [Standard] and [Backlight]/[Spotlight], respectively.	●	–	67
[IR Rec Color]	Changes the color of the infrared picture between white and green.	●	–	114
[IR Light]	Only when MENU > [ Camera Setup] > [IR Light] is set to [Toggle], turns the camcorder's infrared light on/off.	●	–	
[Zebra: All], [Zebra: LCD/VF], [Zebra: LCD], [Zebra: VF], [Zebra: SDI], [Zebra: HDMI]	Turns zebra patterns on/off.	●	–	87
[WFM: All], [WFM: LCD], [WFM: VF], [WFM: SDI] [WFM: HDMI]	Turns the selected video scope on/off.	●	●	103
[LUT: SDI]	Turns on/off the application of the selected LUT.	●	●	154
[View Assist: LCD], [View Assist: VF], [View Assist: HDMI]	Turns view assistance on/off.	●	–	154
[False Color: All], [False Color: LCD], [False Color: VF], [False Color: SDI], [False Color: HDMI]	Turns the false color overlay on/off.	●	–	87
[False Color Index]	Displays/hides the false color index screen.			
[White Balance]	Enters the direct setting mode with the white balance mode highlighted and ready to be adjusted.	●	–	68
[Set White Balance]	Starts the white balance calibration for a custom white balance setting.	●	–	70
[AWB Lock] ¹	While using auto white balance (AWB), locks the current white balance settings.	●	–	69
[ Daylight], [ Tungsten], [ Kelvin]	Changes the white balance mode/setting to the respective option.	●	–	68
[IS Mode]	Toggles between standard and dynamic image stabilization.	●	–	84
[Image Stabilizer]	Turns image stabilization on/off.	●	–	84
[Powered IS]	Turns the Powered IS image stabilizer on/off.	●	–	84
[LCD Setup]	Opens the [ Monitoring Setup] menu page with the settings for adjusting the LCD screen.	●	●	200
[VF Setup]	Opens the [ Monitoring Setup] menu page with the settings for adjusting the viewfinder.	●	●	29
[OSD Output: All], [OSD Output: SDI], [OSD Output: HDMI]	Turns the camera's on screen displays on/off.	●	●	151
[OSD Opacity: All], [OSD Opacity: LCD], [OSD Opacity: VF], [OSD Opacity: SDI], [OSD Opacity: HDMI]	Changes the transparency level of on screen displays.	●	●	152
[DISP]	Changes the onscreen display level.	●	●	46
[OSD Orientation: LCD/VF]	Changes the onscreen display direction in the following order: standard, 90 degrees rotation (to the left), 90 degrees rotation (to the right).	●	–	48

Assignable Buttons

Function name	Description	CAMERA mode	MEDIA mode	
[Markers: All], [Markers: LCD], [Markers: VF], [Markers: SDI], [Markers: HDMI]	Turns onscreen markers on/off.	●	–	85
[Color Bars]	Turns color bars on/off.	●	–	102
[Flicker Reduction]	Turns automatic flicker reduction on/off.	●	–	61
[IP Streaming]	Turns the IP streaming function on/off.	●	–	182
[Photo] ¹	Records a photo.	●	–	42
[Review Recording]	Plays back the last clip recorded in CAMERA mode.	●	–	49
[Time Code]	Opens the [System Setup] menu page with the time code settings.	●	–	88
[Add Shot Mark] ¹	Adds a shot mark to the clip.	●	●	105, 143, 143
[Add Mark], [Add Mark]	Adds an or mark to the clip.	●	●	
[Headphones +], [Headphones –]	Increases/reduces the headphone volume, respectively.	●	●	140
[Monitor Channels]	Switches the audio channels output from the (headphone) terminal and the built-in speaker.	●	●	159
[Audio Level Indicator]	Turns the audio level meter on/off.	●	●	98
[FUNC]	Enters the direct setting mode.	●	–	51
[Slow & Fast Motion]	Turns slow & fast motion recording on/off.	●	–	109
[Slow & Fast Frame Rate]	When slow & fast motion recording is activated, highlights the shooting frame rate in order to adjust it.			
[Output: 60 ⇔ 60 (24) fps] ¹ , [Output: 60 ⇔ 60 (30) fps] ¹	When the frame rate is 59.94P or 59.94i, toggles the frame rate of video output terminals and the LCD screen between said frame rates and 24 fps or 30 fps, respectively.	●	–	–
[Iris]	Enters the direct setting mode with the aperture value highlighted and ready to be adjusted.	●	–	66
[Shutter]	Enters the direct setting mode with the shutter speed highlighted and ready to be adjusted.	●	–	60
[ISO/Gain]	Enters the direct setting mode with the ISO speed or gain value highlighted and ready to be adjusted.	●	–	63
[Status]	Displays the status screens.	●	●	208
[Audio Status]	Displays the [Audio Setup] status screens. You can press SET to open the [Audio Setup] menu.	●	●	212
[Custom Picture]	Opens the [Custom Picture] menu.	●	–	124
[My Menu]	Opens the [My Menu] customized menu.	●	–	26
[Initialize Media]	Opens the [Initialize Media] submenu.	●	●	32
[Play/Pause]	Pauses and resumes the playback.	–	●	137
[INDEX/Cancel Resume] ¹	Returns to the index screen. The next time the clip is selected, playback will start from the beginning.	–	●	137
[INDEX]	Returns to the index screen. The next time the clip is selected, playback will start from the frame where it stopped.			
[REC]	Functions as the REC button. Can only be assigned to assignable button Camera 11.	●	–	41
[Select File]	Displays the file selection screen on the index screen. Additionally, selects a file on the file selection screen.	–	●	137
[Refine]	Displays the [Refine] screen.	–	●	

Function name	Description	CAMERA mode	MEDIA mode	
[MENU] User Setting ¹	Customizable slot. Assign to the button any menu setting you would like to register.	●	●	-

¹ Function can be used only by assigning it to a button.

Custom Picture Settings

The camera lets you change many settings (📖 128) that control various aspects of the image produced. As a set, all these settings are treated as a single custom picture file. After adjusting the desired settings to your preference, you can save up to 20 custom picture files (in the camera or on an SD card), and load them later to apply exactly the same settings (📖 127). You can also save the custom picture file as part of the metadata recorded with XF-AVC clips (📖 127). While recording (excepting pre-recording), and while IP streaming is activated, the custom picture file cannot be selected and some image quality adjustments (including Look Files) are not available.

Selecting Custom Picture Files

In CAMERA mode, select a custom picture file to apply its settings to your recordings or to edit, rename, protect, or transfer it.

1 Select **MENU** > [**CP** Custom Picture] > [Select **CP** File].

- The custom picture file selection screen is displayed.
- Select one of the custom picture files saved in the camera (C1 to C20). To use the settings of a custom picture file saved on an SD card, copy the file to the camera in advance (📖 127).
- You can also use direct touch control's 📷 recording settings (📖 50).

2 Select the desired file.

- When you close the menu, the selected custom picture file's settings will be applied.

Preset Picture Settings

The following settings are saved to custom picture files C1 to C20 as preset custom picture settings. Custom picture files C1 to C9 are protected by default and need to be unprotected before they can be edited.

Preset custom picture file	[Gamma/Color Space]*	[Color Matrix]*	Look File	Characteristics
C1: [BT.709 Normal]	[BT.709 Normal / BT.709]	[Video]	–	These settings are appropriate for playback on BT.709 compliant monitors.
C2: [BT.709 Wide DR]	[BT.709 Wide DR / BT.709]	[Video]	–	These settings produce a wide dynamic range and are appropriate for playback on BT.709 compliant monitors.
C3: [BT.709 Standard]	[BT.709 Standard / BT.709]	[Video]	–	These settings are appropriate for playback on BT.709 compliant monitors, and use a gamma curve that meets ITU-R BT.709 standards.
C4: [Canon Log 3]	[Canon Log 3 / C.Gamut]	[Neutral]	–	These settings use Canon Log 3 gamma and require post-production processing.
C5: [PQ]	[PQ / BT.2020]	[Neutral]	–	These settings use a high dynamic range gamma curve compliant with the PQ standard defined by ITU-R BT.2100.**
C6: [HLG]	[HLG / BT.2020]	[Neutral]	–	These settings use a high dynamic range gamma curve compliant with the HLG standard defined by ITU-R BT.2100.**
C7: [EOS Standard]	[BT.709 Wide DR / BT.709]	[Neutral]	On	Reproduces the image quality and look of an EOS interchangeable lens DSLR camera with its picture style set to [Standard].
C8: [EOS Neutral]	[BT.709 Wide DR / BT.709]	[Neutral]	On	Reproduces the image quality and look of an EOS interchangeable lens DSLR camera with its picture style set to [Neutral].

Preset custom picture file	[Gamma/Color Space]*	[Color Matrix]*	Look File	Characteristics
C9: [Canon 709]	[Canon 709 /BT.709]	[Neutral]	–	These settings produce a look appropriate also for use without post processing, featuring high contrast while ensuring a wide dynamic range optimized for playback on BT.709 compliant monitors.
C10: [USER10] to C20: [USER20]	[BT.709 Normal / BT.709]	[Video]	–	These settings use a gamma curve with a very wide dynamic range, optimized for playback on BT.709 compliant monitors.

* This setting is found under **MENU** > [**CP** Custom Picture] > [Edit **CP** File].

** ITU-R BT.2100 is a standard for a color bit depth of 10 or 12 bits. When the video configuration is set to one of the 8 bit color options, the gamma curve is approximately equivalent to this standard.

NOTES

About the logarithmic gamma curves (Canon Log settings)



- These gamma curves require post-production processing. They were designed to make the most of the imaging sensor characteristics in order to obtain impressive levels of dynamic range.
- In CAMERA mode, you can apply a LUT to the SDI OUT terminal's image to use gamma curve settings more suitable for viewing on a monitor screen.
- There are also other LUTs available that can be applied for processing in post-production. For the latest information on available LUTs, please visit your local Canon website.

About changing custom picture related settings using the RC-V100 Remote Controller



- When an RC-V100 Remote Controller is connected to the camera, you can press the remote controller's CUSTOM PICT. button to open the [**CP** Custom Picture] menu.
- If a protected custom picture file is selected on the camera, custom picture related settings cannot be changed using the remote controller.
- Adjusting custom picture related settings using the remote controller will change the settings registered under the currently selected custom picture file. If you want to keep an important custom picture file, copy it in advance to an SD card or select in advance a custom picture file you do not mind changing.

Editing a Custom Picture File's Settings

In CAMERA mode, adjust the image quality and custom picture file settings to your preference.

- 1 Select a custom picture file ( 124).
- 2 Select **MENU** > [**CP** Custom Picture] > [Edit **CP** File].
 - Select an unprotected custom picture file ( 125).
- 3 Select a setting you wish to change and select the desired option.
 - Refer to *Available Custom Picture Settings* ( 128) for details on the various settings.
 - Repeat step 3 for other settings as necessary.
 - When you close the menu, the new custom picture settings will be applied.

Renaming Custom Picture Files

- 1 Select a custom picture file ( 124).
- 2 Select **MENU** > [**CP** Custom Picture] > [Edit **CP** File] > [Rename] > [Input].
 - Enter the desired file name ( 27).

Protecting Custom Picture Files

Protecting a custom picture file prevents its settings from being accidentally changed.

- 1 Select a custom picture file ( 124).

- 2 Select **MENU** > [**CP** Custom Picture] > [Edit **CP** File] > [Protect] > [Protect].
 -  will appear next to the file name.
 - To remove the protection, select [Unprotect] instead.

Resetting Custom Picture Files

- 1 Select a custom picture file ( 124).
- 2 Select **MENU** > [**CP** Custom Picture] > [Edit **CP** File] > [Reset].
- 3 Select a preset custom picture setting and then select [OK].
 - The custom picture file will be reset to the selected values.

Look Files

You can register LUT files created with Blackmagic Design's DaVinci Resolve as Look Files in the custom picture file. Using a Look File allows you to adjust the video quality of the recorded video. These adjustments apply also to proxy clips, photos, and screen/output terminals.

- 1 Insert the SD card with the desired Look File (.cube format, located in the root directory of the SD card) into the camera's SD card slot B.
- 2 Select a custom picture file. ( 124)
- 3 Select **MENU** > [**CP** Custom Picture] > [Edit **CP** File] > [Gamma/Color Space] > Desired option.
- 4 Select **MENU** > [**CP** Custom Picture] > [Edit **CP** File] > [Look File Setup] > [Register].
 - The Look Files in the SD card will be displayed.
- 5 Select the desired Look File.
- 6 Select the [Gamma/Color Space] setting to use after the Look File is applied.
- 7 Select [OK] twice.
 - The selected Look File will be loaded and registered to the custom picture file.
 - The image quality adjustments set in the Look File will be applied, and **LOOK** will appear on the screen.
 - When disabling the image quality adjustments set in the Look File, select **LOOK** > [**CP** Custom Picture] > [Edit **CP** File] > [Look File] > [Off].

NOTES

About Look files

- The camera supports LUT files (3D LUT/.cube format) in 17 grid or 33 grid format created with Blackmagic Design's DaVinci Resolve.
 - LUT files with input ranges outside the 0 to 1 range in the header ("LUT_3D_INPUT_RANGE") are not supported.
 - LUT files which include values outside of the 0 to 1 range in the data area are not supported.
 - LUT files 2 MB and larger, as well as files with a name containing over 65 characters are not supported.
 - Only the following characters can be used in the file name:
Numbers 0 to 9, upper/lower case letters a to z, underscore (_), hyphen (-), period (.) and a single byte space.
- Save a Look File to the root directory of the SD card.
 - If the correct input/output gamma curve and color space conversion are not selected, video will not be output correctly.
 - A Look File cannot be used if the [Gamma/Color Space], [HLG Color] or [Over 100%] settings are changed after registering it.

- When the gamma curve component of the [Gamma/Color Space] setting in the custom picture is set to either [BT.709 Normal], [BT.709 Standard] or [BT.709 Wide DR], super-white (video signal above 100%) and super-black (video signal below 0%) levels of brightness will be clipped. When the video signal contains super-white brightness levels, select **MENU** > [**CP** Custom Picture] > [Edit **CP** File] > [Other Functions] > [Over 100%] > [Press] and then activate the Look File to apply it to a signal compressed to 100%.

Deleting a Look File

You can delete Look Files registered in custom picture files.

- 1 Select a custom picture file (📖 124).
- 2 Select **MENU** > [**CP** Custom Picture] > [Edit **CP** File] > [Look File Setup] > [Delete] > [OK].
 - The Look File will be deleted and the image quality adjustments will be reversed to the original settings of the selected custom picture file.

Saving a Custom Picture File

Copying Custom Picture Files

You can copy custom picture files between the camera and SD card. Insert in advance into the camera the card where you want to save your custom picture files or the card that contains the custom picture file you want to load.

Copying a File from the Camera to an SD Card

- 1 Select a custom picture file (📖 124).
- 2 Select **MENU** > [**CP** Custom Picture] > [Save **CP** File] > [Copy to SD Card B].
- 3 Select the destination file on the card and then select [OK].
 - Select an existing custom picture file to overwrite it or [New File] to save the settings as a new custom picture file on the card.
- 4 When the confirmation message appears, press SET.

NOTES

- Custom picture files are exclusively compatible for use only with the same camera model.

Replacing a File in the Camera with a File on an SD Card

- 1 Select the custom picture file that you wish to replace (📖 124).
- 2 Select **MENU** > [**CP** Custom Picture] > [Save **CP** File] > [Load from SD Card B].
- 3 Select the file with the settings that you want to replicate and then select [OK].
 - The file in the camera will be overwritten by the one on the card.
- 4 When the confirmation message appears, press SET.

Embedding the Custom Picture File in Clips (CAMERA Mode)

When you record in XF-AVC format after having set custom picture settings, you can have the custom picture file embedded in the metadata and saved along with the clips. When displaying the information screen in MEDIA mode, you can check the custom picture settings used at the time of recording.

Select **MENU** > [ Recording/Media Setup] > [Metadata] > [Add **CP** File] > [On].

Available Custom Picture Settings

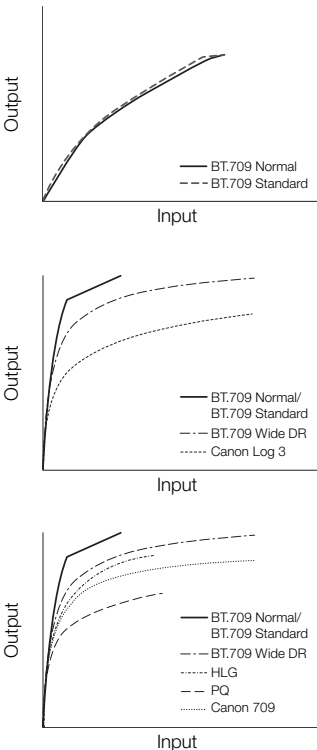
Menu items	Options / Additional information
<p>[Gamma/Color Space]¹</p>  <p>The first graph compares BT.709 Normal (solid line) and BT.709 Standard (dashed line). The second graph compares BT.709 Normal/Standard (solid line), BT.709 Wide DR (dashed line), and Canon Log 3 (dotted line). The third graph compares BT.709 Normal/Standard (solid line), BT.709 Wide DR (dashed line), HLG (dotted line), PQ (dash-dot line), and Canon 709 (dotted line).</p>	<p>[Canon Log 3 / C.Gamut], [Canon Log 3 / BT.2020], [Canon Log 3 / BT.709], [PQ / BT.2020], [HLG / BT.2020], [BT.709 Wide DR / BT.2020], [BT.709 Wide DR / BT.709], [BT.709 Normal / BT.2020], [BT.709 Normal / BT.709], [BT.709 Standard / BT.709], [Canon 709 / BT.709]</p> <p>Combination of gamma curve and color space settings that affects the overall look and color space of the image.</p> <p>Gamma curve</p> <p>[Canon Log 3]: Logarithmic gamma curve that keeps the characteristics of the [Canon Log] setting while expanding its dynamic range. Requires image processing in post-production.</p> <p>[PQ]: HDR (high dynamic range) gamma curve compliant with the PQ standard defined by ITU-R BT.2100.*</p> <p>[HLG]: HDR (high dynamic range) gamma curve compliant with the HLG standard defined by ITU-R BT.2100.*</p> <p>[BT.709 Wide DR]: Gamma curve with a very wide dynamic range. Optimized for playback on BT.709 compliant monitors. Equivalent to the [Wide DR] setting in previous camera models.</p> <p>[BT.709 Normal]: Gamma curve that produces darker dark areas and reduced contrast in the highlights, compared to the ITU-R BT.709 standard. Optimized for playback on BT.709 compliant monitors. Equivalent to the [Normal1] setting in previous camera models.</p> <p>[BT.709 Standard]: Gamma curve that meets ITU-R BT.709 standards, for playback on BT.709 compliant monitors. Equivalent to the [Normal 3] setting in previous camera models.</p> <p>[Canon 709]: Gamma curve appropriate also for use without post processing, featuring high contrast while ensuring a wide dynamic range. Use this when outputting to a BT.709 compliant monitor.</p> <p>* ITU-R BT.2100 is a standard for a color bit depth of 10 or 12 bits. When the video configuration is set to one of the 8 bit color options, the gamma curve is approximately equivalent to this standard.</p> <p>Color space</p> <p>[C.Gamut]: Color space developed by Canon based on the specific characteristics of the camera's imaging sensor. It covers a wider color gamut than that of BT.2020.</p> <p>[BT.2020]: Color space that meets ITU-R BT.2020 standards, which defines parameters for ultra-high-definition television (4K/8K).</p> <p>[BT.709]: Standard color space that is compatible with sRGB specifications.</p>
<p>[Color Matrix]¹</p>	<p>[Neutral], [Production Camera], [Video]</p> <p>The color matrix affects the overall color tonality of the image.</p> <p>[Neutral]: Reproduces neutral colors.</p> <p>[Production Camera]: Reproduces colors more suitable for motion picture production.</p> <p>[Video]: Reproduces colors with a contrast suitable for TV broadcasting.</p>
<p>[Look File]¹</p>	<p>[On], [Off]</p> <p>Image quality adjustments set in the Look File will be applied.</p>
<p>[Look File Setup]¹</p>	
<p>[Register]</p>	<p>Registers a Look File to a custom picture file.</p>
<p>[Delete]</p>	<p>Deletes a Look File registered to a custom picture file.</p>
<p>[HLG Color]¹</p>	<p>[BT.2100], [Vivid]</p> <p>Changes the quality of color reproduction when using the hybrid log gamma (HLG). This setting is only available when [Gamma/Color Space] is set to [HLG / BT.2020].</p> <p>[BT.2100]: Color reproduction according to ITU-R BT.2100 specifications.</p> <p>[Vivid]: More saturated color reproduction according to the 'Traditional Colour' approach in ITU-R BT.2390.</p>

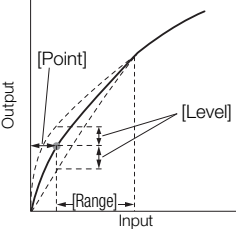
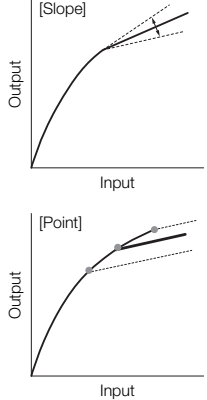
Menu items	Options / Additional information
[Black]	
[Master Pedestal]	<p>–50 to +50 (±0)</p> <p>Increases or decreases the black level. Higher settings will make dark areas brighter but decrease contrast. This setting is not available when the gamma curve component of the [Gamma/Color Space] setting is set to one of the [Canon Log 3] options.</p>
[Master Black Red], [Master Black Green], [Master Black Blue]	<p>–50 to +50 (±0)</p> <p>These settings correct the color cast in blacks. These settings are not available when the gamma curve component of the [Gamma/Color Space] setting is set to one of the [Canon Log 3] options.</p>
[Black Gamma]	
[Level]	–50 to +50 (±0)
[Range], [Point]	–20 to +50 (±0)
	<p>These settings control the lower part of the gamma curve (dark areas of the image). These settings are only available when the gamma curve component of the [Gamma/Color Space] setting is set to one of the [BT.709 Normal] or [BT.709 Standard] options.</p> <p>[Level]: Raises or lowers the lower part of the gamma curve. [Range]: Selects the adjustment range from the selected [Point]. [Point]: Determines the shape of the lower part of the gamma curve.</p>
[Low Key Saturation]	
[Activate]	<p>[On], [Off]</p> <p>Set this setting to [On] to enable the adjustment of color saturation in dark areas with the [Level] setting.</p>
[Level]	<p>–50 to +50 (±0)</p> <p>Specifies how saturated colors are in dark areas.</p>
[Knee]	
[Activate]	<p>[On], [Off]</p> <p>Set this setting to [On] to enable the adjustment of the knee point with the following settings. These settings are only available when the gamma curve component of the [Gamma/Color Space] setting is set to one of the [BT.709 Normal] or [BT.709 Standard] options.</p>
[Automatic]	<p>[On], [Off]</p> <p>Set this setting to [On] to enable the automatic adjustment of the [Knee] settings.</p>
[Slope]	–35 to +50 (±0)
[Point]	50 to 109 (95)
[Saturation]	–10 to +10 (±0)
	<p>These settings control the upper part of the gamma curve (highlights of the image). By compressing the highlights, you can prevent parts of the image from being overexposed.</p> <p>[Slope]: Determines the slope of the gamma curve above the knee point. [Point]: Sets the knee point of the gamma curve. [Saturation]: Adjusts the color saturation in the highlights.</p>

Menu items	Options / Additional information
[Sharpness]	
[Level]	-10 to +50 (±0) Sets the sharpness level of the video output signal and the recorded signal.
[Detail Frequency]	-8 to +8 (±0) Sets the center frequency of horizontal sharpness. Setting higher values increases the frequency, which, in turn, increases the sharpness.
[Coring Level]	-30 to +50 (±0) Sets the level of correction of artifacts caused by high sharpness levels (coring). Higher values prevent sharpness from being applied to minute details, resulting in less noise.
[Limit]	-50 to +50 (±0) Restricts how much sharpness is applied.
[Noise Reduction]	
[Automatic]	[Off], [On]
[Spatial Filter]	[Off] , 1 to 12 Reduces noise by applying a soft focus-like effect on the entire picture. When set to a value other than [Off], afterimages are not produced but the whole image will have a softer look.
[Frame Correlation]	[Off] , 1 to 3 Reduces noise elements by comparing the current image to the previous one (field). When set to a value other than [Off], the perceived resolution will not be affected but an afterimage may appear for moving subjects.
[Skin Detail]	
[Effect Level]	[Off] , [Low], [Middle], [High]
[Hue]	-16 to +16 (±0)
[Chroma], [Area], [Y Level]	0 to 31 (16) The camera applies a softening filter to areas in the picture with skin tones to give a more pleasant appearance. By changing these settings, you can determine what areas will be detected as skin tones. A zebra pattern will appear on the screen or video output terminal over areas of the image that are detected as having skin tones. [Effect Level]: Adjusts the level of the filter. [Hue]: Adjusts the hue for detection of skin tones. [Chroma]: Adjusts the color saturation for detection of skin tones. [Area]: Adjusts the color range for detection of skin tones. [Y Level]: Adjusts the brightness for detection of skin tones.
[Color Matrix Tuning]	
[Gain]	-50 to +50 (±0)
[Phase]	-18 to +18 (±0) These settings adjust the color intensity ([Gain]) and color phase ([Phase]) of the color matrix, affecting the color tones of the whole image.
[R-G], [R-B], [G-R], [G-B], [B-R], [B-G]	-50 to +50 (±0) Each matrix changes the tint of the picture along the color gradations detailed below, affecting the color tones of the whole image. [R-G]: cyan/green and red/magenta; [R-B]: cyan/blue and red/yellow; [G-R]: magenta/red and green/cyan; [G-B]: magenta/blue and green/yellow; [B-R]: yellow/red and blue/cyan; [B-G]: yellow/green and blue/magenta.

Menu items	Options / Additional information
[White Balance]	
[R Gain], [G Gain], [B Gain]	<p>–50 to +50 (±0)</p> <p>These settings adjust the amount of white balance throughout the whole image by changing the intensity of red tones ([R Gain]), green tones ([G Gain]) and blue tones ([B Gain]).</p>
[Color Correction]¹	
[Select Area]	<p>[Off], [Area A], [Area B], [Area A&B]</p> <p>The camera detects areas with certain color characteristics (color phase, chroma, area and Y level) and corrects them when recording. You can set the color correction for up to two different areas (A and B) and apply the color correction to either one ([Area A] or [Area B]) or both of them ([Area A&B]).</p> <p>While color correction is activated, parts of the image that are not detected as having the characteristics specified for area A or B will appear colorless on the screen or the image output from the output terminals (except when adjusting the [Revision Level]/[Revision Phase] settings).</p>
[Area A Setting Phase], [Area B Setting Phase]	<p>0 to 31 (0)</p> <p>These settings determine the color phase of the area to be corrected (A or B, respectively).</p>
[Area A Setting Chroma], [Area B Setting Chroma], [Area A Setting Area], [Area B Setting Area], [Area A Setting Y Level], [Area B Setting Y Level]	<p>0 to 31 (16)</p> <p>These settings determine the following color characteristics of the area to be corrected (A or B, respectively).</p> <p>[Area A Setting Chroma], [Area B Setting Chroma]: Color saturation. [Area A Setting Area], [Area B Setting Area]: Color range. [Area A Setting Y Level], [Area B Setting Y Level]: Brightness.</p>
[Area A Revision Level], [Area B Revision Level]	<p>–50 to +50 (±0)</p> <p>These settings adjust the amount of correction applied to the color saturation in the corrected area (A or B, respectively).</p>
[Area A Revision Phase], [Area B Revision Phase]	<p>–18 to +18 (±0)</p> <p>These settings adjust the amount of correction applied to the color phase in the corrected area (A or B, respectively).</p>
[Other Functions]	
[Over 100%]	<p>[Through], [Press], [Clip]</p> <p>Determines how the camera handles video signals exceeding 100%. This setting is not available when the gamma curve component of the [Gamma/Color Space] setting is set to one of the [Canon Log 3], [PQ], [HLG] or [Canon 709] options.</p> <p>[Through]: Leave the signal unchanged. [Press]: Compress a signal of up to 108% down to 100% levels. [Clip]: Clip the signal at 100%.</p>

¹ These settings cannot be changed during recording or IP streaming (with the exception of pre-recording).

NOTES

- The following settings are not available when infrared recording is activated.
 - [Color Matrix]
 - [HLG Color]
 - [Low Key Saturation]
 - [Knee] > [Saturation]
 - [Skin Detail]
 - [Color Matrix Tuning]
 - [White Balance]
 - [Color Correction]
- Depending on other menu settings, you may not be able to obtain the desired image effect even after changing the custom picture settings.

- When an RC-V100 Remote Controller is connected to the camera, the following custom picture settings can be changed using the buttons and dials on the remote controller.
 - [Black] > [Master Pedestal], [Master Black Red], [Master Black Blue]
 - [Black Gamma] > [Level]
 - [Knee] > [Automatic], [Slope], [Point] (only when [Knee] > [Activate] is set to [On])
 - [Sharpness] > [Level]
 - [White Balance] > [R Gain], [B Gain]

Saving and Loading Menu Settings

After you adjust settings in the various menus, you can save those settings in the camera or on SD card B. You can load those settings at a later date or on another camera of the same model so that you can use that camera in the same way.

Saving Menu Settings

- 1 Select **MENU** > [👉 System Setup] > [Transfer Menu/📁] > [Save].
- 2 Select [To Camera] or [To SD Card B] and then select [OK].
 - The camera's menu settings will be saved to the selected destination. If menu settings were previously saved, the old file will be overwritten by the current menu settings.

Loading Menu Settings

- 1 Select **MENU** > [👉 System Setup] > [Transfer Menu/📁] > [Load].
- 2 Select [From Camera] or [From SD Card B] and then select [OK].
 - The camera's menu settings will be replaced by the settings in the previously saved file. Then, the screen will turn black momentarily and the camera will restart.

NOTES

- The following menu settings are not saved with this operation.
 - **MENU** > [📷 Camera Setup] > [Color Bars]
 - **MENU** > [📷 Recording/Media Setup] > [Metadata] > [News Metadata]
 - **MENU** > [📷 Recording/Media Setup] > [Metadata] > [User Memo]
 - **MENU** > [📷 Assistance Functions] > [Magnification], [Magn. Output]
 - **MENU** > [📷 Assistance Functions] > [Waveform Settings] > [Size: LCD/VF]
- The root certificate for secure FTP transfers is not saved.
- When menu settings are loaded with this operation, even protected custom picture files in the camera will be replaced.

Playback

This section explains how to play back files recorded with the camera. For details on playing back recordings using an external monitor, refer to *Connecting to an External Monitor or External Recorder* (150).

Displaying the Index Screen

- 1 Press the **POWER** switch and set it to ON.
- 2 Press the MEDIA button (14)
 - The camera is set to MEDIA mode and the clip thumbnails will appear in the index screen.
 - Use the joystick to move the orange selection frame.
 - Flick up/down on the screen to move to the next/previous page.



- | | |
|--|---|
| <ol style="list-style-type: none"> 1 Key lock (15) 2 Shot mark¹ (143) 3 OK mark¹/✓ mark¹ (143) 4 Orange selection frame 5 Proxy clip (55) 6 Clip identification (camera index, reel number, clip number and clip/audio file name) (37) 7 Recording date and time 8 Network status / functions (180) 9 Recording media A / B <ul style="list-style-type: none"> • An orange dot will be displayed next to the card currently selected. 10 Index screen currently displayed (136) | <ol style="list-style-type: none"> 11 File selection (137) <ul style="list-style-type: none"> • The file selection screen is displayed. 12 Chunk recording clip (57) 13 Clip thumbnail 14 Power supply level (45) 15 Clip number / Total number of clips 16 Recording date (month and day only) and time 17 Clip's start time code 18 Clip duration 19 Custom picture file embedded¹ (127) 20 Special recording mode (109) 21 Color sampling and resolution, audio recording format 22 Frame rate² (54) |
|--|---|

¹ XF-AVC clips only.

² For clips recorded using slow & fast motion recording, the shooting frame rate and playback frame rate will both be displayed.

i NOTES

- If the card contains XF-AVC clips recorded at a system frequency other than the one currently used by the camera, you will not be able to play back the clips and the clip thumbnails will not appear in the index screen. To play back such clips, change the camera's system frequency (📖 54) to match the recordings on the card.

Switching Card Slots

If both card slots contain a card, press the SLOT SELECT button to play back recordings from the other card. You can also switch card slots by touching the orange dot next to the card currently selected.

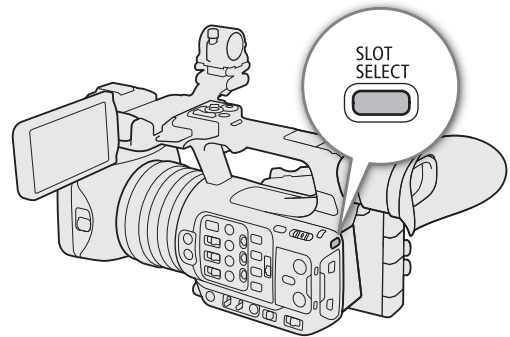

Switching Index Screens

The clip index screen that appears when you switch to MEDIA mode depends on the current recording settings.

- 1 Press the INDEX button.
 - The index screen selection menu appears.
 - You can also touch the recording format on the index screen to display the index screen selection menu.
- 2 Select the desired index screen.
 - The selected index screen appears.
 - You can also select an index screen by touching the respective recording format displayed on the screen.
 - Select [Cancel] to return to the previous index screen.

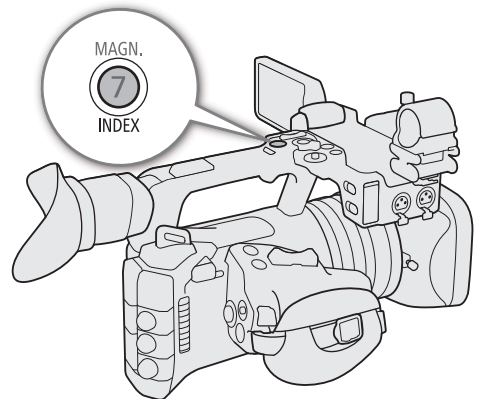

Options

[XF-AVC Index]: Clips in XF-AVC format.

[MP4 Index]: Clips in MP4 format.

[Photo index]: Photos recorded on the card.

[WAV Index]: Audio files in WAV format.

Playing Back Recordings

After selecting the desired index screen, play back the desired clips, photos or audio files. You can use the touch screen, assignable buttons, or joystick to play back the recordings.

Touch the thumbnail of the recording you want to play back.

- Playback will start.
- You can also move the orange selection frame using the joystick, and then press and hold the joystick (for approximately 1 second) to start playback.
- Touch the screen to display the PAUSE icon (||), then touch it to pause playback. You can also press the joystick to pause/resume playback.
- Press the INDEX button or flick the screen down to stop the playback and return to the index screen.
- While browsing photos, press the joystick left/right to move to the previous/next photo.

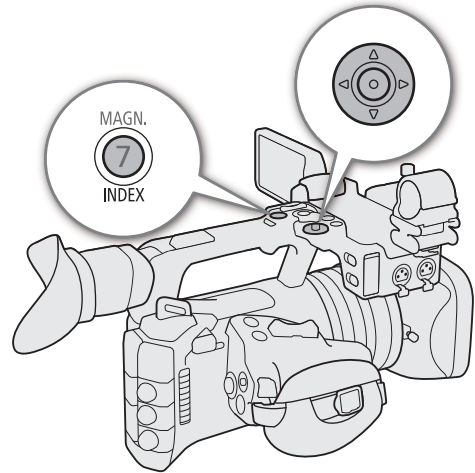

i NOTES

- The following image files may not be displayed correctly.
 - Images not recorded with this camera.
 - Images edited on a computer.
 - Images whose file names have been changed.
- Chunk recording clips are not played back.

Refining Clip Selection for Playback

Play back only the selected clips in succession.

- 1 Touch on the index screen.
 - The file selection screen is displayed.
 - Touch to return to the index screen.
- 2 Touch a thumbnail to select a clip, then touch .
 - The Refine screen is displayed.
 - Touch to return to the file selection screen, or to return to the index screen.
- 3 Touch the desired thumbnail on the Refine screen.
 - Subsequent operations are the same as for *Playing Back Recordings*.
 - Once playback ends, the screen returns to the Refine screen.



File selection screen example

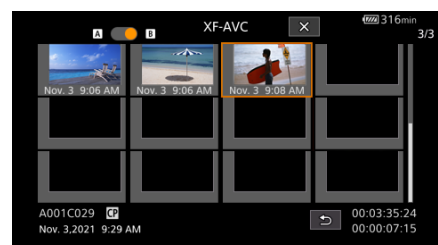

Refine screen example

Onscreen Displays During Clip Playback

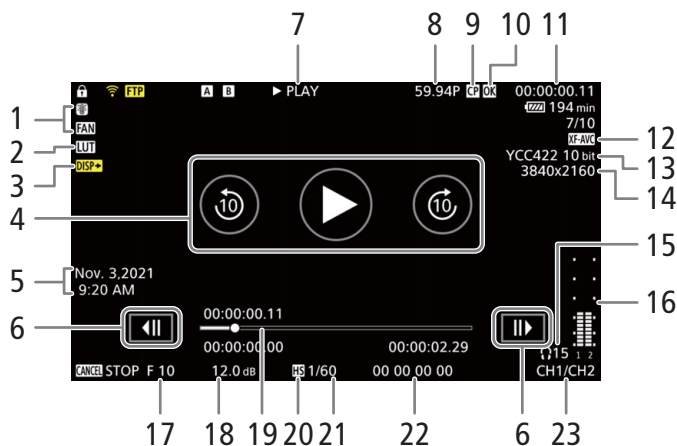

- | | |
|--|---|
| <p>1 Fan operation (📖 40) and temperature warning (📖 220)</p> <p>2 LUT (📖 154)</p> <p>3 Output onscreen displays (📖 151)</p> <p>4 Playback button ▶
Advance 10 seconds ⏩
Go back 10 seconds ⏪</p> <p>5 Recording date and time¹</p> <p>6 Frame reverse button ◀◀◀
Frame advance button ▶▶▶</p> <p>7 Playback operation</p> <ul style="list-style-type: none"> ▶ PLAY Playback ⏸ PAUSE Playback pause 10 sec ▶▶▶ Advance 10 seconds ◀◀◀ 10 sec Go back 10 seconds ◀◀◀/▶▶▶ Frame reverse/Frame advance F FWD x5 Fast forward (speed: x5) F FWD x15 Fast forward (speed: x15) F FWD x60 Fast forward (speed: x60) F REV x5 Rewind (speed: x5) F REV x15 Rewind (speed: x15) F REV x60 Rewind (speed: x60) | <p>8 Frame rate² (📖 54)</p> <p>9 Custom picture file embedded³ (📖 127)</p> <p>10 <input type="checkbox"/> mark³/<input checked="" type="checkbox"/> mark³ / Proxy clip (📖 55, 143)</p> <p>11 Time code (📖 88)</p> <p>12 Video format (📖 54)</p> <p>13 Color sampling and color bit depth (📖 54)</p> <p>14 Resolution (📖 54)</p> <p>15 Headphone volume (📖 140)</p> <p>16 Audio level meter⁴</p> <p>17 Aperture value⁵ (📖 65)</p> <p>18 ISO speed/Gain⁵ (📖 62)</p> <p>19 Progress bar</p> <p>20 High sensitivity mode recording (📖 63)</p> <p>21 Shutter speed⁵ (📖 60)</p> <p>22 User bit (📖 90)</p> <p>23 Audio output channels (📖 159)</p> |
|--|---|

¹ Only when [📄 Monitoring Setup] > [Custom Display] > [Date/Time] is set to [On].
² For clips recorded using slow & fast motion recording, the shooting frame rate and playback frame rate will both be displayed.
³ XF-AVC clips only.
⁴ Only when [📄 Monitoring Setup] > [Custom Display] > [Audio Level Indicator] is set to [On].
⁵ Only when [📄 Monitoring Setup] > [Custom Display] > [Camera Data] is set to [On].

i NOTES

- You can press the DISP button repeatedly to change the level of onscreen displays (📖 46).

WAV file playback screen

See *Onscreen Displays During Clip Playback* (📖 138) for the description of onscreen displays that are common on all playback screens.

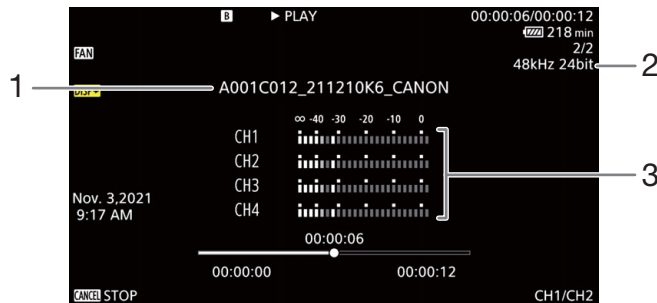

- 1 Audio file name
2 Sampling frequency and bit depth
3 Audio level meter

Clip Playback Controls

The following playback types are available using the joystick and the touch screen. You can also change the position in the video using the progress bar.

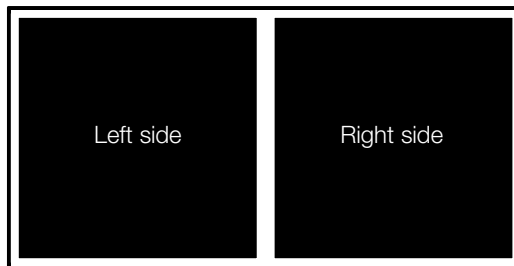

Playback type	Operation
Fast playback ¹	During playback, push the joystick up or down. Repeat to increase the playback speed to approximately 5x → 15x → 60x the normal speed ² .
Advance 10 seconds	During playback, touch the right side of the screen twice. During playback pause, touch Ⓢ on the right side of the screen.
Go back 10 seconds	During playback, touch the left side of the screen twice. During playback pause, touch Ⓢ on the left side of the screen.
Frame advance/reverse	During playback pause, push the joystick up or down, or touch ◀▶▶▶.
Skip to the beginning of the next clip	During playback/playback pause, push the joystick right or flick the screen to the left.
Skip to the beginning of the current clip	During playback/playback pause, push the joystick left.
Skip to the previous clip	During playback, push the joystick left twice. During playback/playback pause, flick the screen to the right.
Change the playback/playback pause position in the video	During playback/playback pause, touch or slide the progress bar.

¹ You may notice some anomalies (blocky video artifacts, banding, etc.) in the playback picture.

² The speed indicated on the screen is approximate.

NOTES

- There is no audio during any of the playback types listed in the previous table.

Adjusting the Volume

You can use headphones or the built-in speaker to listen to the audio during normal playback. When you connect headphones to the  (headphone) terminal, the speaker will be muted. The audio signal will also be output from the SDI OUT terminal and the HDMI OUT terminal.

1 Select **MENU** > [] **Audio Setup** > [**Headphone Volume**] or [**Speaker Volume**].

2 Select the desired level.

NOTES

- For details on changing the audio channel, refer to *Audio Output Channels* (📖 159).
- If you set an assignable button to [**Headphones +**] or [**Headphones -**] (📖 119), you can press the button to adjust the headphone volume without using the menu.

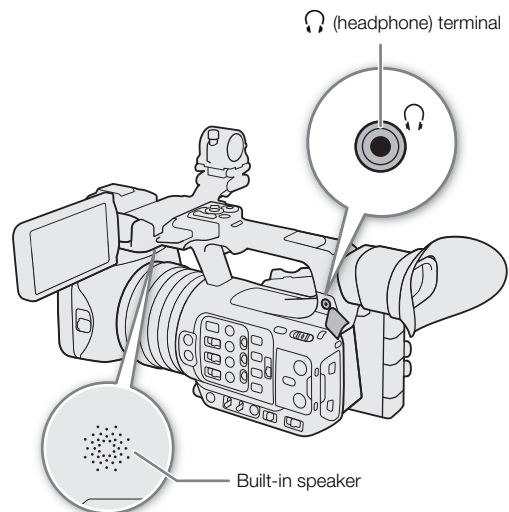







File Operations

You can perform various operations on the file selected in the index screen using the file menu. Available options will depend on the type of recording selected.

File Menu Operations



- 1 Select the desired recording.
- 2 Press SET.
 - The file menu will be displayed. Available functions will differ depending on the recording.
 - You can also touch the screen for approximately 1 second to display the file menu.
- 3 Select a menu item.

File menu options

Menu item	Description	Index screen			
		[XF-AVC]	[MP4]	[Photos]	[WAV]
[Cancel]	Closes the menu.	●	●	●	●
[Play] ¹	Starts playback.	●	●	●	●
[Display Clip Info]	Displays the information screen (📖 142).	●	●	–	–
[Select]	Displays the file selection screen on the index screen. Alternatively, selects a file on the file selection screen.	●	●	–	–
[Deselect]	Clears selection for a file.	●	●	–	–
[Deselect All]	Clears selection for all files and returns to the index screen.	●	●	–	–
[Refine]	Displays the Refine screen.	●	●	–	–
[End Refining]	Returns from the Refine screen to the index screen.	●	●	–	–
[Reselect]	Returns from the Refine screen to the selection screen.	●	●	–	–
[Add  Mark] or [Delete  Mark] ^{2, 3}	Adds or deletes an  mark (📖 143, 143).	●	–	–	–
[Add  Mark] or [Delete  Mark] ^{2, 3}	Adds or deletes a  mark (📖 143, 143).	●	–	–	–
[Del. All Shot Marks] ²	Deletes all the shot marks (📖 144).	●	–	–	–
[Recover] ¹	Recovers a recording.	●	●	–	●
[Delete]	Deletes a recording (📖 144).	●	●	●	●
[Delete User Memo]	Deletes the user memo and GPS information of a clip (📖 144).	●	●	–	–
[FTP Transfer]	Transfers a clip using the FTP protocol (📖 181).	●	●	–	–
[Stop]	Ends photo playback.	–	–	●	–

¹ Excluding chunk recording clips.

² Excluding proxy clips.

³ If the clip already contains an  or  mark, the option to delete the mark will appear in the menu.

Displaying Clip Information

1 Select the desired clip in the clip index screen.

2 On the file menu, select [Display Clip Info].

- The [Clip Info] screen will appear.
- Push the joystick left/right to move to the previous/next clip. Press the CANCEL button to return to the index screen.



- | | |
|---|---|
| 1 Thumbnail of the selected clip | 10 Shot mark (P) and OK mark / OK mark ³ (P) |
| 2 Clip geotagged with GPS information | 11 Custom picture file embedded ³ (YCC422) |
| 3 Thumbnail of the previous clip | 12 Proxy clip (S)/Chunk recording clip (S) |
| 4 Thumbnail of the next clip | 13 Color sampling ³ and color bit depth (10 bit) |
| 5 Special recording mode ¹ (S&F REC) | 14 Clip's start time code |
| 6 Recording date and time | 15 Clip's end time code |
| 7 Clip file name (A001C007_211210F6_CANON) | 16 Clip duration |
| 8 Compression, bit rate and resolution (LongGOP 260 Mbps 3840x2160) | |
| 9 Frame rate ² (59.94P) | |

¹ INT REC, FRM REC or S&F REC will be displayed depending on the special recording mode.
² For clips recorded using slow & fast motion recording, the shooting frame rate and playback frame rate will both be displayed.
³ XF-AVC clips only.

Displaying User Memo/News Metadata

From the [Clip Info] screen, you can push the joystick up or down, or touch [▲]/[▼] on the screen to display user memo or News Metadata details. To return to the [Clip Info] screen, push the joystick in the direction displayed to the left of [Clip Info] at the bottom of the screen ([←]/[→]) or touch [Clip Info] at the top of the screen.

Displaying Custom Picture Settings

If a custom picture file was embedded with the clip, you can push the joystick up or down, or touch [▲]/[▼] on the screen to display the custom picture settings used. To return to the [Clip Info] screen, push the joystick in the direction displayed to the left of [Clip Info] at the bottom of the screen ([←]/[→]) or touch [Clip Info] at the top of the screen.

Adding **OK** Marks or **✓** Marks

You can add an OK mark (**OK**) or check mark (**✓**) to XF-AVC clips to help you identify particular clips. Since clips with an **OK** mark cannot be deleted with the camera, you can use this mark also to protect important clips.

Adding an **OK** Mark or **✓** Mark During Playback

You can add an **OK** mark or **✓** mark to a clip during playback or playback pause.

- 1 Set an assignable button to [Add **OK** Mark] or [Add **✓** Mark] (📖 119).
- 2 During playback/playback pause of an XF-AVC clip, press the assignable button to add the clip mark.
 - [**OK**Mark] or [**✓**Mark] will appear briefly and the selected clip mark will be added to the clip.
 - Playback will be paused.

Adding an **OK** Mark or **✓** Mark from the Index Screen

- 1 Select the desired clip from the XF-AVC index screen.
- 2 Press SET (file menu) and select [Add **OK** Mark] or [Add **✓** Mark] > [OK].
 - The selected clip mark is added to the clip.

i NOTES

- A clip cannot have both an **OK** mark and **✓** mark at the same time. When you add a **✓** mark to a clip with an **OK** mark, the **OK** mark will be deleted. Similarly, when you add an **OK** mark to a clip with a **✓** mark, the **✓** mark will be deleted.

Deleting **OK** Marks or **✓** Marks

You can delete an **OK** mark or **✓** mark added to an XF-AVC clip.

- 1 Select the desired clip from the XF-AVC index screen.
- 2 Press SET (file menu) and select [Delete **OK** Mark] or [Delete **✓** Mark] > [OK].
 - The selected mark is deleted.

Adding/Deleting Shot Marks

During the playback of a clip recorded in XF-AVC format, you can add shot marks (**S**) to particular frames in the clip that you want to single out. You can also delete all shot marks at once.

Adding Shot Marks during Playback

- 1 Set an assignable button to [Add Shot Mark] (📖 119).
- 2 During playback/playback pause of an XF-AVC clip, press the assignable button at the point in the clip where you want to add the shot mark.
 - [Shot Mark] will appear briefly and the shot mark will be added to the current frame of the clip.
 - Playback will be paused.

Deleting All the Shot Marks from a Clip

- 1 Select the desired XF-AVC clip in the index screen.
- 2 Press SET (file menu) and select [Del. All Shot Marks] > [OK].
 - All shot marks in the selected clip are deleted.

Deleting Recordings

You can delete clips, photos and audio files in WAV format. To delete clips with an **OK** mark, you need to delete the **OK** mark beforehand (📖 143).

- 1 Select the desired file in the index screen.
 - Photos are selectable on the playback screen.
- 2 Press SET (file menu) and select [Delete] > [OK].
 - The file is deleted.
 - The operation cannot be canceled.

IMPORTANT

- **Be careful when deleting recordings. Once deleted, they cannot be recovered.**

Deleting the User Memo and GPS Information from a Clip

- 1 Select the desired clip in the index screen.
- 2 Press SET (file menu) and select [Delete User Memo] > [OK].
 - The user memo and GPS information that were recorded in the selected clip's metadata are deleted.

Video Output Configuration

The video signal output from the SDI OUT terminal or the HDMI™ OUT terminal, depends on the clip's video configuration and on various menu settings.

HDMI OUT Terminal Video Output Configuration (Recording)

Main recording video configuration			MENU > [System Setup]	Video output configuration ¹	MENU > [System Setup]	Video output configuration ¹
Main recording format	Resolution	Frame rate	[HDMI Output Signal]	HDMI OUT terminal ²	[SDI Output Signal]	SDI OUT terminal ²
XF-AVC MP4(HEVC) MP4(H.264)	3840x2160	59.94P 50.00P	3840x2160P	3840x2160	3840x2160P	3840x2160
			1920x1080P	1920x1080	1920x1080P	1920x1080
			1920x1080i	1920x1080 59.94i / 50.00i	1920x1080i (PsF)	1920x1080 59.94i / 50.00i
			1280x720P	1280x720	1280x720P	1280x720
			-	-	720x480i ³ 720x576i ³	720x480 59.94i 720x576 50.00i
		29.97P 25.00P	3840x2160P	3840x2160	3840x2160P	3840x2160
			1920x1080P	1920x1080	1920x1080P	1920x1080
			1920x1080i	1920x1080 59.94i / 50.00i	1920x1080i (PsF)	1920x1080 29.97PsF (59.94i) / 25.00PsF (50.00i)
			1280x720P	1280x720 59.94P / 50.00P	1280x720P	1280x720 59.94P / 50.00P
			-	-	720x480i ³ 720x576i ³	720x480 29.97PsF (59.94i) 720x576 25.00PsF (50.00i)
		23.98P	3840x2160P	3840x2160	3840x2160P	3840x2160
			1920x1080P	1920x1080	1920x1080P	1920x1080
			1920x1080i	1920x1080 59.94i	1920x1080i (PsF)	1920x1080 59.94i
			1280x720P	1280x720 59.94P	1280x720P	1280x720 59.94P
			-	-	720x480i	720x480 59.94i

Main recording video configuration			MENU > [System Setup]	Video output configuration ¹	MENU > [System Setup]	Video output configuration ¹
Main recording format	Resolution	Frame rate	[HDMI Output Signal]	HDMI OUT terminal ²	[SDI Output Signal]	SDI OUT terminal ²
XF-AVC MP4(HEVC) MP4(H.264)	1920x1080	59.94P 50.00P	1920x1080P	1920x1080	1920x1080P	1920x1080
			1920x1080i	1920x1080 59.94i / 50.00i	1920x1080i (PsF)	1920x1080 59.94i / 50.00i
			1280x720P	1280x720	1280x720P	1280x720
			-	-	720x480i ³ 720x576i ³	720x480 59.94i 720x576 50.00i
		59.94i ⁴ 50.00i ⁴	1920x1080i	1920x1080	1920x1080i (PsF)	1920x1080
			1280x720P	1280x720 59.94P / 50.00P	1280x720P	1280x720 59.94P / 50.00P
			-	-	720x480i ³ 720x576i ³	720x480 59.94i 720x576 50.00i
			1920x1080P	1920x1080	1920x1080P	1920x1080
		29.97P 25.00P	1920x1080i	1920x1080 59.94i / 50.00i	1920x1080i (PsF)	1920x1080 29.97PsF (59.94i) / 25.00PsF (50.00i)
			1280x720P	1280x720 59.94P / 50.00P	1280x720P	1280x720 59.94P / 50.00P
			-	-	720x480i ³ 720x576i ³	720x480 29.97PsF (59.94i) 720x576 25.00PsF (50.00i)
			1920x1080P	1920x1080	1920x1080P	1920x1080
	23.98P	1920x1080i	1920x1080 59.94i	1920x1080i (PsF)	1920x1080 59.94i	
		1280x720P	1280x720 59.94P	1280x720P	1280x720 59.94P	
		-	-	720x480i	720x480 59.94i	
		1280x720P	1280x720	1280x720P	1280x720	
	1280x720	59.94P 50.00P	1280x720P	1280x720	1280x720P	1280x720
			-	-	720x480i ³ 720x576i ³	720x480 59.94i 720x576 50.00i

¹ In most cases, the output signal's frame rate will be the same as that used for recording (except when slow & fast motion recording is activated).

² Color sampling will be YCC422 10 bit. The video signal's effective bit depth will be output.

³ Available options depend on the system frequency.

When the camcorder's language is set to simplified Chinese this setting is not available. Conversely, when this resolution is selected, [简体中文] (simplified Chinese) will not appear as one of the camcorder's language options.

⁴ Only when MENU > [Recording/Media Setup] > [Main Rec Format] is set to [XF-AVC YCC422 10 bit].

Video Output Configuration (Playback)

Main recording video configuration			MENU > [System Setup]	Video output configuration ¹	MENU > [System Setup]	Video output configuration ¹
Main recording format	Resolution	Frame rate	[HDMI Output Signal]	HDMI OUT terminal ²	[SDI Output Signal]	SDI OUT terminal ²
XF-AVC MP4 (HEVC) MP4 (H.264)	3840x216	59.94P 50.00P	3840x2160P	3840x2160	3840x2160P	3840x2160
			1920x1080P	1920x1080	1920x1080P	1920x1080
			1920x1080i	1920x1080 59.94i / 50.00i	1920x1080i (PsF)	1920x1080 59.94i / 50.00i
			1280x720P	1280x720	1280x720P	1280x720
			-	-	720x480i ³ 720x576i ³	720x480 59.94i 720x576 50.00i
		29.97P 25.00P	3840x2160P	3840x2160	3840x2160P	3840x2160
			1920x1080P	1920x1080	1920x1080P	1920x1080
			1920x1080i	1920x1080 59.94i / 50.00i	1920x1080i (PsF)	1920x1080 29.97PsF (59.94i) / 25.00PsF (50.00i)
			1280x720P	1280x720 59.94P / 50.00P	1280x720P	1280x720 59.94P / 50.00P
			-	-	720x480i ³ 720x576i ³	720x480 29.97PsF (59.94i) 720x576 25.00PsF (50.00i)
		23.98P	3840x2160P	3840x2160	3840x2160P	3840x2160
			1920x1080P	1920x1080	1920x1080P	1920x1080
			1920x1080i	1920x1080 59.94i	1920x1080i (PsF)	1920x1080 59.94i
			1280x720P	1280x720 59.94P	1280x720P	1280x720 59.94P
			-	-	720x480i	720x480 59.94i

Main recording video configuration			MENU > [☛ System Setup]	Video output configuration ¹	MENU > [☛ System Setup]	Video output configuration ¹		
Main recording format	Resolution	Frame rate	[HDMI Output Signal]	HDMI OUT terminal ²	[SDI Output Signal]	SDI OUT terminal ²		
XF-AVC MP4 (HEVC) MP4 (H.264)	1920x1080	59.94P 50.00P	3840x2160P	1920x1080	3840x2160P	1920x1080		
			1920x1080P		1920x1080P			
			1920x1080i	1920x1080 59.94i / 50.00i	1920x1080i (PsF)	1920x1080 59.94i / 50.00i		
			1280x720P	1280x720	1280x720P	1280x720		
			-	-	720x480i ³ 720x576i ³	720x480 59.94i 720x576 50.00i		
		59.94i 50.00i	3840x2160P	1920x1080	3840x2160P	1920x1080	3840x2160P	1920x1080
			1920x1080P		1920x1080P			
			1920x1080i		1920x1080i (PsF)			
			1280x720P	1280x720 59.94P / 50.00P	1280x720P	1280x720 59.94P / 50.00P		
			-	-	720x480i ³ 720x576i ³	720x480 720x576		
		29.97P 25.00P	3840x2160P	1920x1080	3840x2160P	1920x1080	3840x2160P	1920x1080
			1920x1080P		1920x1080P			
			1920x1080i	1920x1080 59.94i / 50.00i	1920x1080i (PsF)	1920x1080 29.97PsF (59.94i) / 25.00PsF (50.00i)		
			1280x720P	1280x720 59.94P / 50.00P	1280x720P	1280x720 59.94P / 50.00P		
			-	-	720x480i ³ 720x576i ³	720x480 29.97PsF (59.94i) 720x576 25.00PsF (50.00i)		
		23.98P	3840x2160P	1920x1080	3840x2160P	1920x1080	3840x2160P	1920x1080
			1920x1080P		1920x1080P			
			1920x1080i	1920x1080 59.94i	1920x1080i (PsF)	1920x1080 59.94i		
			1280x720P	1280x720 59.94P	1280x720P	1280x720 59.94P		
			-	-	720x480i	720x480 59.94i		
1280x720	59.94P 50.00P	3840x2160P	1280x720	3840x2160P	1280x720			
		1920x1080P		1920x1080P				
		1920x1080i		1920x1080i (PsF)				
		1280x720P		1280x720P				
		-	-	720x480i ³ 720x576i ³	720x480 59.94i 720x576 50.00i			

Main recording video configuration			MENU > [👉 System Setup]	Video output configuration ¹	MENU > [👉 System Setup]	Video output configuration ¹
Main recording format	Resolution	Frame rate	[HDMI Output Signal]	HDMI OUT terminal ²	[SDI Output Signal]	SDI OUT terminal ²
MP4 (H.264)	1280x720	29.97P 25.00P	3840x2160P	1280x720 59.94P / 50.00P	3840x2160P	1280x720 59.94P / 50.00P
			1920x1080P		1920x1080P	
			1920x1080i		1920x1080i (PsF)	
			1280x720P		1280x720P	
		–	–	720x480i ³ 720x576i ³	720x480 29.97PsF (59.94i) 720x576 25.00PsF (50.00i)	
		23.98P	3840x2160P	1280x720 59.94P	3840x2160P	1280x720 59.94P / 50.00P
			1920x1080P		1920x1080P	
			1920x1080i		1920x1080i (PsF)	
			1280x720P		1280x720P	
			–	–	720x480i	720x480 59.94i

¹ In most cases, the output signal's frame rate will be the same as that used for recording.

² Color sampling will be YCC422 10 bit. The video signal's effective bit depth will be output.

³ Available options depend on the system frequency.

Connecting to an External Monitor or External Recorder

When you connect the camera to an external device, be it a monitor (to monitor the recording or for playback) or an external video recorder (for recording), adjust the required settings in the menu. For details about output signals, refer to *Video Output Configuration* (📖 145).

Connection diagram

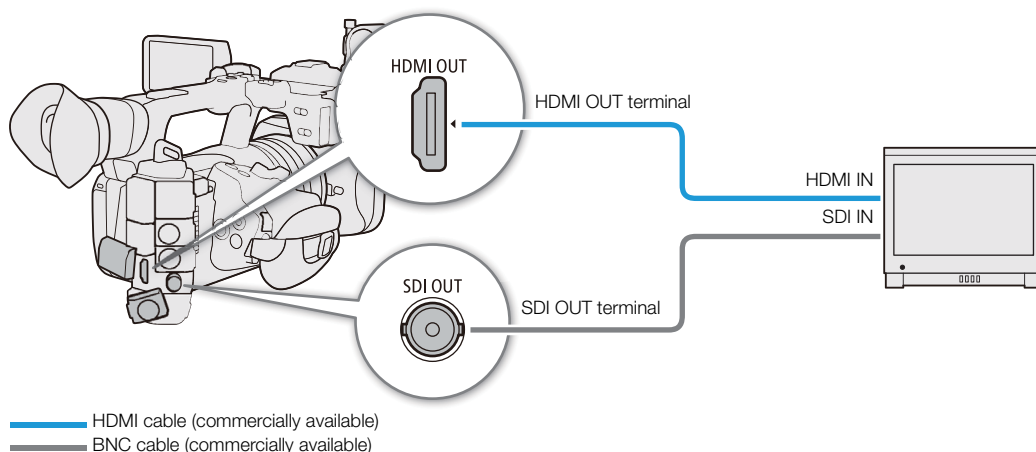

i NOTES

- Powering the camera from a power outlet using an AC adapter is recommended.

Using the SDI OUT Terminal

The digital signal that is output from the SDI OUT terminal includes the video signal, audio signal, time code signal and the recording command signal. When using the SDI OUT terminal, you can output various assistance displays (onscreen displays, markers, etc.) in order to check them also on an external monitor.

- 1 Select **MENU** > [**⚙** System Setup] > [SDI Output] > [On].
- 2 To change the 3G-SDI mapping level, select **MENU** > [**⚙** System Setup] > [3G-SDI Mapping] > [Level A] or [Level B].
 - You can select a video output signal compliant with Level A or Level B of the SMPTE ST 425-1 standard.

SD Resolution Output

Select the desired output method when outputting in SD resolution.

Select **MENU**> [**⚙** System Setup] > [SD Resize on Output] > Desired option.



i NOTES

- You can set **MENU** > [**📷** Recording/Media Setup] > [Rec Command(EXT REC)] to [On] to use the camera's REC button to control also the recording operation of an external recorder connected to the SDI OUT terminal. However, the recording command will not be output during slow & fast motion recording, interval recording, frame recording or continuous recording, so this function cannot be used when said recording modes are activated.
- When the frame rate is 23.98P and [SDI Output Signal] is set to [1280x720P], the frames value of the time code output from the SDI OUT terminal will be converted so it runs from 0 to 29.



- When outputting in SD resolution and using the magnification function, [SD Resize on Output] will be locked to [Squeeze].

Using the HDMI OUT Terminal

The digital signal that is output from the HDMI™ OUT terminal includes the video signal and audio signal. You can output also the time code signal, recording command and various assistance displays (onscreen displays, markers, etc.) in order to check them also on an external monitor. In CAMERA mode, the camera's time code can be output as well.

- 1 Connect the HDMI cable to the HDMI OUT terminal.
- 2 Select **MENU** > [ System Setup] > [HDMI Output Signal] > Desired option.
- 3 To output the time code signal, select **MENU** > [ Recording/Media Setup] > [HDMI Time Code] > [On].

NOTES

- You can set **MENU** > [ System Setup] > [Linked to HDMI Monitor] to [On] to automatically change the HDMI OUT terminal's output resolution according to the capabilities of the connected monitor. When this setting is set to [Off], the output resolution is set according to the menu settings and if the connected monitor is not compatible with the signal output from the camera, HDMI output will stop.
- The HDMI OUT terminal is for output only. Do not connect the camera to another device's output terminal using the HDMI OUT terminal as this will cause a malfunction.
- Correct operation cannot be guaranteed when connecting the camera to DVI monitors.
- Video may not be output correctly depending on the connected external monitor/recorder or the HDMI cable used. In such case, use another terminal.
- If the camera's time code is being output and **MENU** > [ Recording/Media Setup] > [Rec Command(EXT REC)] is set to [On], you can use the camera's REC button to control also the recording operation of an external recorder connected to the HDMI OUT terminal.
- During slow & fast motion recording, interval recording, frame recording or continuous recording, the recording command will not be output.
- The time code will not be output from the HDMI OUT terminal in the following cases.
 - In MEDIA mode.
- If **MENU** > [ System Setup] > [HDMI Output Signal] is set to [1280x720P], when the frame rate is set to 23.98P, the frames value of the time code output from the HDMI OUT terminal will be converted so it runs from 0 to 29.

Superimposing Onscreen Displays on Video Outputs

You can output the camera's onscreen displays along with the video output from the SDI OUT terminal or the HDMI OUT terminal to check the onscreen displays on an external monitor. You can also adjust the opacity level of superimposed onscreen displays. This setting will not affect your recordings.

Select **MENU** > [ Monitoring Setup] > One of the [OSD Output:] settings > [On].

- **DISP** appears on the right of the screen (In CAMERA mode, only if **MENU** > [ Monitoring Setup] > [Custom Display 2] > [OSD Output] is set to [On]).

NOTES

- If you set an assignable button to one of the [OSD Output:] settings, you can press the button to turn the camera's onscreen displays on and off.

Changing the Opacity Level of Onscreen Displays

You can make onscreen displays more visible or less conspicuous by changing their opacity level. You can select to which screens to apply the opacity levels.

- 1 To change the visibility of onscreen displays on individual video outputs, select **MENU** > [⏏] Monitoring Setup] > Desired [OSD Opacity:] setting > [On].
- 2 Select **MENU** > [⏏] Monitoring Setup] > [OSD Opacity Level] > Desired option.
 - The smaller the percentage the more transparent the onscreen displays.
- 3 Select **MENU** > [⏏] Monitoring Setup] > [OSD Opacity: Appl. Screens] > [All] or [Only Rec/Playback Screens].
 - You can apply the selected opacity level to all onscreen displays (including menus, etc.) or only to onscreen displays on the shooting and playback screens.

NOTES

- If you set an assignable button to one of the [OSD Opacity:] settings, you can press the button to change the opacity level of onscreen displays on the corresponding video outputs.

Selecting the Output Range

You can select the output range of video signals (when using log gamma or PQ/HLG HDR) output from the SDI OUT terminal or the HDMI OUT terminal to determine how the image levels are mapped to code values. Moreover, you can select the setting independently for Canon Log output and for HDR output.

Applied output range settings

Custom picture file			Applied range settings
[Gamma]	[Look File]	[Gamma/Color Space] after the Look File is applied	MENU > [⏏] Monitoring Setup] > [Range: SDI] / [Range: HDMI]
[Canon Log 3]	[Off]	–	[During Canon Log Output]
	[On]	[Conform to Custom Picture]	
[PQ]	[Off]	–	[During HDR Output]
	[On]	[Conform to Custom Picture]	
[HLG]	[Off]	–	
	[On]	[Conform to Custom Picture]	
[BT.709 Wide DR]	[Off]	–	– (Fixed narrow range)
	[On]	[Conform to Custom Picture]	
[BT.709 Normal]	[Off]	–	
	[On]	[Conform to Custom Picture]	
[BT.709 Standard]	[Off]	–	
	[On]	[Conform to Custom Picture]	
[Canon 709]	[Off]	–	
	[On]	[Conform to Custom Picture]	
–	[On]	[SDR BT.709]	[During HDR Output]
		[SDR BT.2020]	
		[HDR PQ(BT.2100)]	
		[HDR HLG(BT.2100)]	

When using the SDI OUT terminal

- 1 Select **MENU** > [ Monitoring Setup] > [Range: SDI].
- 2 Select [During Canon Log Output] or [During HDR Output] > Desired option.
 - Repeat the procedure as necessary to select the output range for other terminals or output signals.

Options for [Range: SDI]

[Full Range]: The signal output will use full range coding.

[Narrow Range]:
The signal output will use narrow range (video range) coding.

When using the HDMI OUT terminal

- 1 Select **MENU** > [ Monitoring Setup] > [Range: HDMI].
- 2 Select [During Canon Log Output] or [During HDR Output] > Desired option.

Options

[Full Range Priority]:
The signal output will use full range coding whenever possible but will change the range automatically according to the capabilities of the connected monitor.

[Narrow Range]:
The signal output will use narrow range (video range) coding.

NOTES

- Settings will change depending on the gamma curve component of the [Gamma/Color Space] setting in the custom picture file and the [Gamma/Color Space] setting after a Look File has been applied. When a LUT is applied, settings will change also depending on the gamma curve selected for the output signal. If a user LUT is applied, the output range will be determined by the user LUT's [Range (Output)] setting.
- During playback, the applied range is determined according to the gamma used at the time of recording.
- When [View Assist: HDMI] ( 158) is set to [On], [Range: HDMI] is disabled.

Applying a LUT/the View Assistance Function to the LCD Screen

While recording using special gamma curves, you can apply a LUT to the image output from the SDI OUT terminal or the View Assistance function to the image displayed on the screen and video output from the HDMI OUT terminal. These functions change the color space (and in some settings, the gamma curve) used, making it easier to check the image on the display device used.

Whether or not a LUT/the View Assistance function can be used, and the available LUTs, depend on the [Gamma/Color Space] and [Look File] settings in the custom picture file (📖 126). If these settings are changed, LUT/view assistance will be turned off.

LUTs

List of LUTs

Applied LUT	Output settings with LUT applied		Description
	Gamma curve	Color space	
[BT.709]	BT.709 Wide DR	BT.709	LUT for viewing on external monitors compatible with BT.709 specifications.
[BT.2020]	BT.709 Wide DR	BT.2020	LUT for viewing on external monitors compatible with ITU-R BT.2020 standards, which define parameters for ultra-high-definition television (4K/8K).
[DCI]	DCI	DCI-P3	LUT for viewing on external monitors that support color spaces and gamma curves that follow the guidelines established by DCI (Digital Cinema Initiatives).
[PQ]	PQ	BT.2020	LUT for viewing HDR (high dynamic range) images on external monitors compatible with the PQ standard defined by ITU-R BT.2100. The signal output will use narrow range (video range) coding.
[HLG]	HLG	BT.2020	LUT for viewing HDR (high dynamic range) images on external monitors compatible with the HLG standard defined by ITU-R BT.2100. The signal output will use narrow range (video range) coding.
[CMT 709]	CMT 709	BT. 709	LUT for viewing on external monitors compatible with BT.709 specifications. It produces a look suitable for a cinema production, keeping a wide dynamic range without clipping when log recording.
[User LUT1] to [User LUT4]	Registered gamma curve	BT.709, BT.2020, unchanged	LUT for viewing on the LCD screen. Used to check the registered gamma curve, as well as the color space and range settings.

Available LUTs

Custom picture file		Available LUTs						
[Look File]	[Gamma/Color Space] after the Look File is applied	[BT.709]	[BT.2020]	[DCI]	[PQ]	[HLG]	[CMT 709]	[User LUT1] to [User LUT4]
[Off]	–	See the following table (A)						
	[Conform to Custom Picture]							
[On]	[SDR BT.709]	–	–	–	–	–	–	–
	[SDR BT.2020]	●	–	–	–	–	–	–
	[HDR PQ(BT.2100)]	●	–	–	–	–	–	–
	[HDR HLG(BT.2100)]	●	–	–	–	–	–	–

Available LUTs (A)

Custom picture file	Available LUTs						
[Gamma/Color Space]	[BT.709]	[BT.2020]	[DCI]	[PQ]	[HLG]	[CMT 709]	[User LUT1] to [User LUT4]
[Canon Log 3 / C.Gamut]	●	●	●	●	●	●	●
[Canon Log 3 / BT.2020]	●	●	–	●	●	–	●
[Canon Log 3 / BT.709]	●	–	–	–	–	–	●
[PQ / BT.2020]	●	–	–	–	–	–	–
[HLG / BT.2020]	●	–	–	–	–	–	–
[BT.709 Wide DR / BT.2020]	●	–	–	–	–	–	–
[BT.709 Wide DR / BT.709]	–	–	–	–	–	–	–
[BT.709 Normal / BT.2020]	–	–	–	–	–	–	–
[BT.709 Normal / BT.709]	–	–	–	–	–	–	–
[BT.709 Standard / BT.709]	–	–	–	–	–	–	–
[Canon 709 / BT.709]	–	–	–	–	–	–	–

View Assistance

List of View Assistances

Applied View Assistance	Output settings with View Assistance applied		Description
	Gamma curve	Color space	
[BT.709] or [On (BT.709)] ¹	Equivalent to BT.709 Wide DR	Equivalent to BT.709	View Assistance for viewing on the LCD screen.
[CMT 709]	Equivalent to CMT 709	Equivalent to BT.709	View Assistance for viewing on the LCD screen. It produces a look suitable for a cinema production, keeping a wide dynamic range without clipping when log recording.
[HDR Assist. (800%)] ²	Original gamma curve	Equivalent to BT.709	View Assistance for viewing HDR (high dynamic range) images. The View Assistance follows the ITU-R BT.2100 transfer function to convert a brightness range of 800% or 400% respectively into a linear brightness scale.
[HDR Assist. (400%)] ²			

¹ Only **MENU** > [⏏] Monitoring Setup > [View Assist: HDMI] can be selected.

² Excluding **MENU** > [⏏] Monitoring Setup > [View Assist: HDMI].

Available View Assistances

Custom picture file	Available View Assistances				
[Look File]	[Gamma/Color Space] after the Look File is applied	[BT.709]	[CMT 709]	[HDR Assist. (800%)]	[HDR Assist. (400%)]
[Off]	–	See the following table (B)			
	[Conform to Custom Picture]				
[On]	[SDR BT.709]	–	–	–	–
	[SDR BT.2020]	●	–	–	–
	[HDR PQ(BT.2100)]	●	–	–	●
	[HDR HLG(BT.2100)]	●	–	–	●

Available View Assistances (B)

[Gamma/Color Space]	Available View Assistances			
	[BT.709]	[CMT 709]	[HDR Assist. (800%)]	[HDR Assist. (400%)]
[Canon Log 3 / C.Gamut]	●	●	●	●
[Canon Log 3 / BT.2020]	●	–	●	●
[Canon Log 3 / BT.709]	●	–	–	–
[PQ / BT.2020]	●	–	–	●
[HLG / BT.2020]	●	–	–	●
[BT.709 Wide DR / BT.2020]	●	–	–	–
[BT.709 Wide DR / BT.709], [BT.709 Normal / BT.2020], [BT.709 Normal / BT.709], [BT.709 Standard / BT.709], [Canon 709 / BT.709]	–	–	–	–

Applying a LUT

- 1 Select **MENU** > [📺] Monitoring Setup > [LUT: SDI] > [On].
 - The LUT is applied and the gamma curve and color space of the displayed image will change.
- 2 Select **MENU** > [📺] Monitoring Setup > [LUT Selection: SDI] > Desired LUT.
 - When only one option is available, it will be grayed out.

NOTES

- If you set an assignable button to [LUT: SDI] (📄 119), you can press the button to turn the selected LUT on and off.
- The LUT will be temporarily disabled when you select **MENU** > [🔧] Assistance Functions > [False Color: LCD] > [On].

Adjusting the Color Quality for HLG Output

You can change the quality of the color reproduction when the [HLG] LUT is used.

Select **MENU** > [📺] Monitoring Setup > [HLG Color] > Desired option.

Options

- [BT.2100]: Color reproduction according to ITU-R BT.2100 specifications.
- [Vivid]: More saturated color reproduction according to the 'Traditional Colour' approach in ITU-R BT.2390.

User LUTs

You can register in the camera up to four LUT files created with Blackmagic Design's DaVinci Resolve as user LUTs and apply them to video output from the SDI OUT terminal. User LUTs can be applied when the gamma in the custom picture file is a log gamma curve. You can adjust the output color space and range of user LUTs. Use an SD card to copy LUT files to the camera.

Registering a User LUT

- 1 Insert the SD card with the desired LUT file (.cube format) into the camera's SD card slot B.

- 2 Select **MENU** > [⏏] Monitoring Setup] > [User LUT 1] to [User LUT 4] > [Register].
- 3 Select the LUT file on SD card B.
- 4 Select the color space for the output signal ([Color Space (Output)]).
 - To leave the color space unchanged, select [Do Not Convert] instead.
- 5 Select the output range ([Range (Output)]).
- 6 Select [OK].
 - The selected LUT file will be registered in the camera.

Applying a User LUT

- 1 Select **MENU** > [⏏] Monitoring Setup] > [LUT: SDI] > [On]
- 2 Select **MENU** > [⏏] Monitoring Setup] > [LUT Selection: SDI] > Desired option.
 - After registering a user LUT, it will appear as one of the options ([USERLUT1 ★] to [USERLUT4 ★]) when you select the desired LUT.
 - Only registered user LUTs are listed in the options.

Deleting a User LUT

- 1 Select **MENU** > [⏏] Monitoring Setup] > [User LUT 1] to [User LUT 4] > [Delete] > [OK].
 - The selected user LUT will be deleted.

Resetting All the User LUTs

- 1 Select **MENU** > [⏏] Monitoring Setup] > [Reset All User LUTs] > [OK].
 - All user LUTs will be deleted.

Renaming a User LUT

You can rename each of the four user LUTs in the camera.

- Select **MENU** > [⏏] Monitoring Setup] > [User LUT 1] to [User LUT 4] > [Rename].
- Enter the desired LUT name (up to 8 characters) using the keyboard screen (📖 27).

Checking a User LUT's Settings

Select **MENU** > [⏏] Monitoring Setup] > [User LUT Info] > Desired user LUT.

NOTES

About LUT files

- The camera supports LUT files (3D LUT/.cube format) in 17 grid or 33 grid format created with Blackmagic Design's DaVinci Resolve.
- LUT files with input ranges outside the 0 to 1 range in the header ("LUT_3D_INPUT_RANGE") are not supported.
- LUT files which include values outside of the 0 to 1 range in the data area are not supported.
- LUT files 2 MB and larger, as well as files with a name containing over 65 characters are not supported.
- Only the following characters can be used in the file name:
Numbers 0 to 9, upper/lower case letters a to z, underscore (_), hyphen (-), period (.) and a single byte space.
- Save a LUT file to the root directory of the SD card.
- If the correct color space for the output signal ([Color Space (Output)]) is not selected, video will not be output correctly.
- User LUT files in the camera cannot be overwritten. If necessary, delete a user LUT file in the camera before registering a different LUT file.

Applying the View Assist Function

1 Select **MENU** > [⏏] Monitoring Setup > one of the [View Assist:] settings > [On].

- The view assistance function is applied and the gamma curve and color space of the displayed image will change.
- The signal output will use narrow range (video range) coding.
- You can also adjust this setting using direct touch control (📖 50).

2 Select **MENU** > [⏏] Monitoring Setup > One of the [Select View Assist:] settings.

- When only one option is available, it will be grayed out.

NOTES

- Setting [View Assist: HDMI] to [On] disables the > [⏏] Monitoring Setup > [Range: HDMI] setting.
- The colors modified by using this function are an approximation, and when [BT.709] is selected, differ from the colors obtained when you set [Gamma/Color Space] in the custom picture file (📖 128) to [BT.709 Wide DR / BT.709].
- The colors in the dark areas / highlights of the image may not be displayed accurately.

Adjusting the Gain Difference When Converting HDR to SDR

You can adjust the SDR gain difference relative to HDR within a range of ± 7.5 dB (in 0.5 dB increments) in the following cases:

- When the main clip is set to HDR* and a LUT or view assistance function that changes the color space to BT.709 is applied to the output.
- When the main clip is set to HDR* and [Proxy Rec Color Conversion] is set to [BT.709 (Wide DR)] / [BT.709 (CMT 709)].

* When the [Gamma/Color Space] setting in the custom picture file is set to [PQ / BT.2020] or [HLG / BT.2020], or when the [Gamma/Color space] setting after applying a Look File is set to [HDR PQ (BT.2100)] or [HDR HLG (BT.2100)].

Select **MENU** > [⏏] Monitoring Setup > [Gain for HDR→SDR Conv.] > Desired option.

Audio Output Channels

The camera can output audio from the SDI OUT terminal or the HDMI OUT terminal,  (headphone) terminal or speaker. When recording or playing back clips recorded with 4-channel audio, you can select which audio channels are output from the HDMI OUT terminal and headphones.

Audio output configuration

Recorded audio configuration		Audio output during recording/playback		
Audio format	Audio bit depth	SDI OUT terminal	HDMI OUT terminal	 (headphone) terminal
4-channel linear PCM	24 bit, 16 bit	4-channel linear PCM 24 bit	2-channel linear PCM 16 bit	2 channels
2-channel AAC	16 bit			

To select the audio channels for headphone output

Select **MENU** > [] Audio Setup] > [Monitor Channels] > Desired audio output option (L/R).

- Options like [CH1+2] indicate that two audio channels (CH1 and CH2 in this example) are mixed and output from the same side.

To select the audio channels for HDMI output

Select **MENU** > [] Audio Setup] > [HDMI OUT Channels] > [CH1/CH2] or [CH3/CH4].

Working with Files on a Computer

Canon offers software applications as free downloads that allow you to save on a computer/smartphone files recorded with the camera.

160

Saving Files

Use Canon XF Utility to save and organize XF-AVC clips and other recorded files on a computer. You can use the Canon XF plugins to easily use XF-AVC clips directly from Avid non-linear editing (NLE) software. The software and plugins are available as free downloads from your local Canon website. Check the download page for the system requirements and latest information.

You will find detailed instructions about installing and uninstalling the software in the "Read This First" file (Install-XF Utility.pdf) included in the compressed file you will download from the website. For details about using the software, refer to the instruction manual (PDF file) that is installed with the software.

Canon XF Utility (for Windows/macOS): Software application that allows you to save clips on a computer, check, play back and organize clips and grab still frames from clips.

Canon XF Plugin for Avid Media Access (for Windows/macOS): Plugin that allows you to easily import clips from a card or a local folder in the computer to the compatible version of Avid Media Composer (an NLE application compatible with Avid Media Access), directly from within the application.

Saving MP4 Clips

Make sure to save clips recorded with this camera to a computer. To do so, you will need a card reader connected to a computer or a computer with an SD card slot. For details on transferring files from the SD card, refer to the computer's instruction manual or OS's help modules.

Under certain circumstances, clips may be split and recorded as separate files. Using MP4 Join Tool you can join the split files of and save them as a single seamless clip.

Transferring Files to a Computer

- 1 Insert an SD card with the desired clips into the SD card slot of the computer or card reader connected to the computer.
- 2 Follow the OS's onscreen instructions.
- 3 Copy the clips on the SD card to the computer.
 - Recordings on the SD card are located in folders named "XXX_mmdd" under the "DCIM" folder, where XXX is the folder number (100 to 999) and mmdd stands for the recording date (📖 38).

Joining Clips Split by the Camera

Use MP4 Join Tool to join MP4 clips split by the camera in the following cases.

- When the camera switches to the other SD card while recording video due to the relay recording function (📖 35).
- The video (stream) file in the clip will be split approximately every 4 GB. Clips are also split during chunk recording.

MP4 Join Tool is available as a free download (for Windows or macOS) from your local Canon website. Check the download page for the system requirements and latest information.

You will find detailed instructions about installing and uninstalling the software in the "Read This First" file (Install-MP4 Join Tool.pdf) included in the compressed file you download. For details about using the software, refer to the instruction manual (PDF file) that is installed with the software.

Saving WAV Files

Audio files in WAV format can be saved to a computer in the same way as MP4 files. Copy the desired audio files (located in the “/PRIVATE/AUDIO” folder of the SD card) to the computer.

Saving Recordings to a Smartphone

You can save MP4 clips and proxy clips recorded with the camera, as well as News Metadata files to a smartphone. A Content Transfer Mobile is needed for this operation. You can connect a smartphone to the camera using a compatible USB cable* or the network functions (📖 194).

* For details on compatible USB cables, visit your local Canon website.

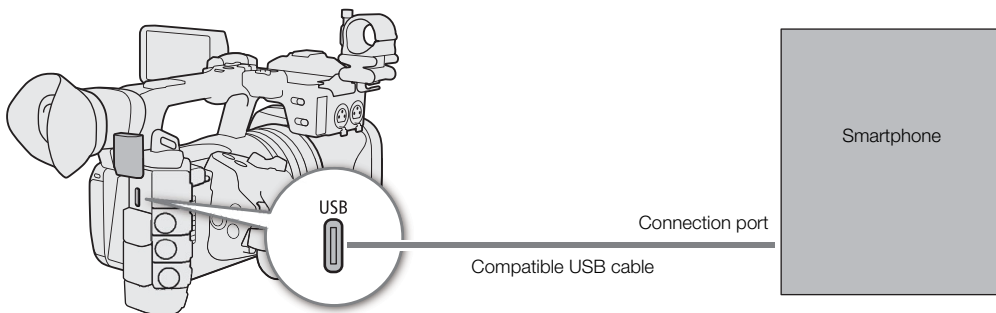

- 1 Select **MENU** > [🔧 System Setup] > [USB (Type-C) Mode] > [Canon App(s) for iPhone].
- 2 Connect the smartphone to the camera using a compatible USB cable.
- 3 Open the application on the smartphone.
- 4 Use the application to save the files.
- 5 When the connection ends, disconnect the USB cable from the camera.

NOTES

- Chunk recording clips cannot be saved to a smartphone.

Automatically Transferring Recording Data to an FTP Server

You can use Content Transfer Mobile to automatically transfer proxy and chunk recording clips (in MP4 format) to an FTP server. Install Content Transfer Mobile on your smartphone in advance (📖 194).

- 1 **Connect the smartphone to the camera.**
 - When using a USB cable, perform steps 1 to 3 of *Saving Recordings to a Smartphone* (📖 161).
 - When using network functions, perform steps 2 to 6 of *Transferring Recordings to a Smartphone* (📖 194).
- 2 **Smartphone: specify the destination FTP server on Content Transfer Mobile, and enable the automatic recording transfer function.**
- 3 **Enable proxy clip recording (📖 55) or chunk recording (📖 57), then press REC to start recording.**
 - Recorded clips are automatically transferred.
- 4 **End the connection.**
 - When using a USB cable, perform step 5 of *Saving Recordings to a Smartphone* (📖 161).
 - When using network functions, perform step 8 of *Transferring Recordings to a Smartphone* (📖 194).

Network functions and connection types

You can use the following network functions by connecting the camera to a network using Wi-Fi or the  (Ethernet) terminal.

Network function	Description	Wired network (Ethernet)	Wi-Fi		
			Infrastructure ¹	Camera Access Point ²	
FTP File Transfer	Transfer clips recorded with the camera to another device connected to the network using the FTP protocol.			●	181
IP Streaming	Stream the camera's live video and audio over IP to a compatible IP video decoder connected to the network.	●	●	–	182
Browser Remote	Control the camera remotely from the Web browser of a connected device.			●	184
Canon App	Transfer clips/audio recorded with the camera to a smartphone, or apply News Metadata created/edited with the Content Transfer Mobile to the camera.	–	●	–	194
XC Protocol	Control the camera remotely through an IP connection using a controller/application compatible with the XC protocol.	●	●	●	191

¹ Connection to a Wi-Fi network via an external access point (wireless router, etc.)

² Direct connection to one Wi-Fi-enabled device where the camera serves as the Wi-Fi access point.

Before using the network functions

- The instructions in this chapter assume you already have a correctly configured and working network and correctly configured network device(s). If necessary, refer to the documentation provided with the network devices you plan to use.
- Configuring the network settings requires adequate knowledge about configuring and using wired (Ethernet) and/or wireless (Wi-Fi) networks. Canon cannot provide support regarding network configurations.

IMPORTANT

- Canon shall not be liable for any loss of data or damage resulting from incorrect network configuration or settings. Additionally, Canon shall not be liable for any loss or damage caused by the use of network functions.
- Avoid using open networks or networks without sufficiently strong security settings. Using an unprotected network can expose your data to monitoring by unauthorized third parties.

i NOTES

- Do not open the card compartment cover while using network functions.
- Do not place cables connected to the camera's SDI OUT terminal or HDMI OUT terminal, INPUT terminals, MIC terminal or USB terminal near the built-in wireless antenna. Doing so may negatively affect the wireless communication or the audio recorded.

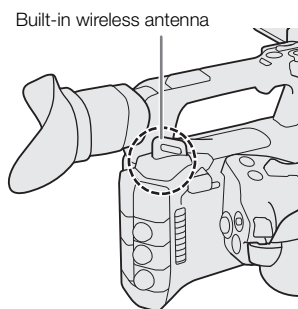

Using a Wi-Fi Network

Wi-Fi Connection Types

You can connect the camera in Infrastructure mode, using an access point (wireless router etc.), or in Camera Access Point mode, directly to a network device. The type of connection you can use, depends on the network function you wish to use (📖 163).

For an Infrastructure connection, the camera offers 4 ways to configure an access point and the method you use will depend on the type and specifications of the access point and network you plan to use.

Camera Access Point: When shooting in a location where there are no access points available, the camera can serve as a wireless access point*. Wi-Fi enabled devices will be able to connect to the camera directly.

* Limited only to the connection between the camera and supported Wi-Fi enabled devices. The functionality is not the same as that of commercially available access points.

Infrastructure connection:

WPS (button): If your wireless router supports Wi-Fi Protected Setup (WPS), setup will be easy and require minimal configuring and no passwords. To check if your wireless router has a WPS button and for details about how to activate the Wi-Fi protected setup, refer to the instruction manual of your wireless router.



WPS (PIN code): Even if your wireless router does not have a dedicated WPS button, it may support WPS using a PIN code instead. For setup using a PIN code, you will need to know in advance how to activate the wireless router's WPS function. For details refer to the instruction manual of your wireless router.

Searching for Access Points: If your access point does not support the WPS function or you are using a smartphone's mobile connection (tethering), you can have the camera search for access points in the area.

Entering the SSID and authentication method: Manually enter the SSID and other information about the access point.

! IMPORTANT

- Depending on the country/region of use, some restrictions on outdoor use or Camera Access Point connections may apply when using the IEEE 802.11b/g/a/n/ac wireless standard. Check the applicable areas of use and restrictions in advance (📖 237).

Using a Wired (Ethernet) Network

Connect a commercially available Ethernet cable to the camera's  (Ethernet) terminal to use a wired network. Use Category 5e or better shielded twisted pair (STP) Ethernet cables compatible with Gigabit Ethernet (1000BASE-T) and with good shielding capability. For more details about the Ethernet adapter and Ethernet cables, refer to the manufacturer's instruction manual.

Connecting

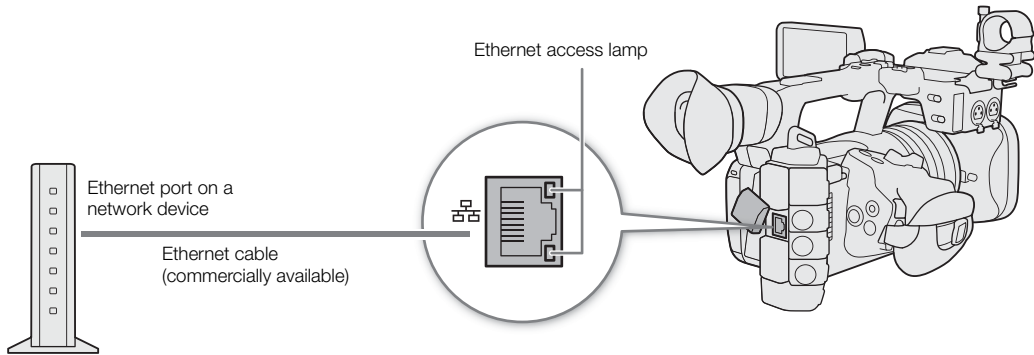

Configuring Connection Settings

To connect to a network you will need to define in advance a connection setting (SET), which is a combination of one or two communication settings (networks, NW) and one or two network function settings (MODE). You can save in the camera up to 25 individual communication settings and function settings, and up to 20 combinations of connection settings (SET1 to SET20).

To configure a connection setting for the first time, you will follow the setup wizard (📖 167). Using the wizard, you can set up only one network and one function per connection setting. After having configured multiple connection settings, you can change them (for example to add a secondary network or second function) and you can create new ones combining existing communication and function settings (📖 175).

If you configure a connection setting with both the [IP Streaming] and [Browser Remote] network functions, you will be able to use both functions simultaneously.

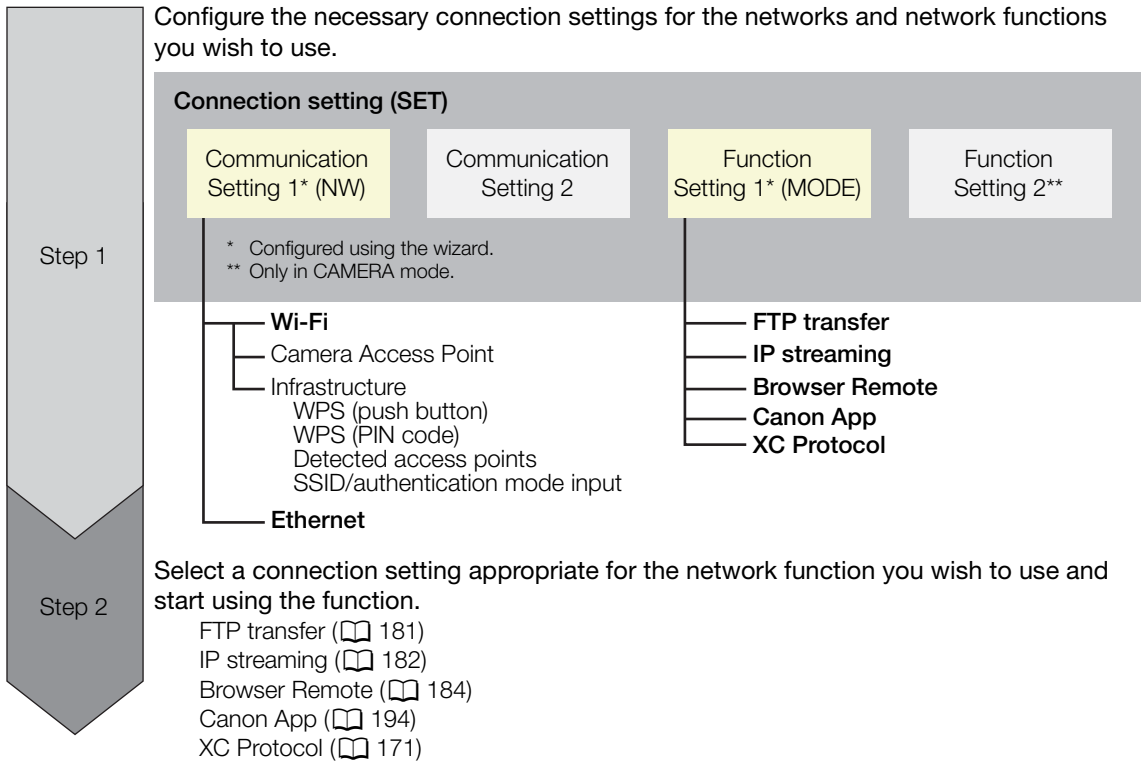

Activating a Network Connection

Activate the desired network connection to use network functions or to configure the connection setting online.

- 1 Select **MENU** > [📶 Network Settings] > [Network] > [Enable].
- 2 When using connection settings that you saved previously, select **MENU** > [📶 Network Settings] > [Connect] > Desired connection setting ([SET1] to [SET20]) > [OK].
 - To end the network connection, set [Connect] to [Disconnect] instead.

Adding a New Connection Setting Using the Wizard

You can use the wizard to set up a new connection setting. This section uses a connection to a Wi-Fi network using the WPS push button method as an example. Refer to the instruction manual of the access point for details about the location and operation of the WPS button.

- 1 Enable the network functions (📖 166).
- 2 Select **MENU** > [📶 Network Settings] > [New Conn. Setting (Wizard)] > Desired network function > [OK].
- 3 Select [Create New Comm. Setting].
 - Once you have added multiple communication settings, you can select [Select Existing Setting] to reuse the settings for a network that you saved previously.
- 4 Select [Wi-Fi 📶].
 - To configure a wired (Ethernet) network (📖 171).
- 5 Select [Connect with WPS] > [WPS (Push Button)].
 - To use a different configuration method, complete the corresponding procedure.
 - Camera Access Point (📖 171)
 - WPS using a PIN code (📖 172)
 - Detected access points (📖 173)
 - SSID/authentication mode input (📖 173)
 - Manual setup without connecting to the network (📖 174)
- 6 Press and hold the WPS button on the wireless router and then, on the camera, select [OK].
- 7 To configure the IPv4 settings automatically and not use IPv6 settings, select [Automatic Setting] > [Disable].
 - To configure IPv4 settings manually (📖 174).
 - To use the default IPv6 settings, select [Enable] instead. After completing the wizard, change the IPv6 settings as necessary (📖 177).
- 8 Select [OK] to continue to configure the function settings.
 - The communication settings are saved to an [NW] file.
 - Continue with one the following procedures to configure the selected function's settings.
 - FTP transfer (📖 167), IP streaming (📖 169), Browser Remote (📖 170), Canon App (📖 170), XC Protocol (📖 171)

NOTES

- The [WPS (Push Button)] method may not work correctly depending on the devices used or the surrounding conditions. In such case try using [WPS (PIN Code)] (📖 172) or selecting one of the detected networks (📖 173).

Function Settings

FTP Transfer

This section continues the connection settings wizard (📖 167). In the function settings you will configure the FTP server settings and other settings related to the handling of folders and files. If necessary, consult the network administrator in charge of the FTP server.

- 1 Select [Create New Func. Setting].
 - Once you have added multiple function settings, you can select [Select Existing Setting] to reuse the settings for an FTP server that you saved previously.
- 2 Select the desired transfer mode.

3 Configure the destination FTP server. Select [Server] and [Port No.] > [OK].

- Enter the FTP server's IP address or host name using the keyboard screen. Enter the port number using the data entry screen (☞ 27).
- Usually, the port number used is 21 (FTP or FTPS transfers) or 22 (SFTP transfers).
- Depending on the FTP mode selected in step 2, perform either step 4 or steps 4-5 and then continue to step 6.

SFTP transfers

4 Enter the user name and password for the SSH protocol's authentication. Select [User Name] and [Password] > [OK].

- Enter the desired user name and password using the keyboard screen (☞ 27).

FTP/FTPS transfers

4 Select [Enable] to use passive mode or [Disable] to use active mode.

- In most cases, select [Disable].

5 Enter the user name and password for the FTP server. Select [User Name] and [Password] > [OK].

- Enter the desired user name and password using the keyboard screen (☞ 27).

All transfer modes

6 Select the destination folder on the server.

7 Select [OK]

- The function settings are saved to a [MODE] file.

8 Select the connection setting (SET1 to SET20) where to save the settings.

9 Select [OK].

- The camera will connect to the network and will be ready to use the FTP transfer function (☞ 181).

Options for [FTP Mode]

[FTP]: Transfer method where the data is not encrypted.

[FTPS]: Secure transfer method using a root certificate (☞ 174).

[SFTP]: Secure transfer method using an SSH secure channel.

Options for [Destination Folder]

[Root Directory]: Files are saved on the root directory of the destination FTP server.

[Select Folder]: Enter the desired path using the keyboard screen (☞ 27). If the folder does not exist on the destination FTP server, it will be created automatically.

IP Streaming

This section continues the connection settings wizard (□ 167). In the function settings you will configure the streaming video bit rate and resolution, the protocol used and the receiver's settings. For details refer to the instruction manual of the decoder device or software you will use.

- 1 Select [Create New Func. Setting].
 - Once you have added multiple function settings, you can select [Select Existing Setting] to reuse IP streaming settings that you saved previously.
- 2 Select the desired protocol.
 - Depending on the selected protocol, perform steps 3 to 6 if necessary and then continue to step 7.

[RTP+FEC] streaming

- 3 Configure the receiver's settings. Select [Destination Server] and [Dest. Port No.] > [OK].
 - Enter the receiver's IP address using the keyboard screen. Enter the port number using the data entry screen (□ 27).
 - Using the default port number is recommended.
- 4 Configure the settings used to send FEC packets. Select [FEC Port No.] and [FEC Interval] > [OK].
 - Enter the port number using the data entry screen (□ 27).
 - Using the default settings is recommended.
 - Proceed to step 7.

[RTSP+RTP] streaming

- 3 Configure the receiver's settings. Select [Destination Server] and [Dest. Port No.] > [OK].
 - Enter the receiver's IP address using the keyboard screen. Enter the port number using the data entry screen (□ 27).
 - Using the default port number is recommended.
- 4 Enter the user name and password of the RTSP client. Select [RTSP: User Name] and [RTSP: Password] > [OK].
 - Enter the desired user name and password using the keyboard screen (□ 27).
 - Proceed to step 7.

SRT

- 3 Select the connection mode.

Caller: Connect to a decoder or a computer from the camera.

Listener: Listens for connections from the decoder or computer.
- 4 When [Caller] is selected, enter [Destination Server], [Dest. Port No.] and [Stream ID], then select [OK].
 - Using the default port number is recommended.
- 5 When [Listener] is selected, enter [Listening Port No.] then select [OK].
 - Enter the port number of the decoder or computer.
- 6 Select [Encryption Settings], enter [Passphrase] and [Latency], and then select [OK].

All streaming protocols

- 7 Select the video streaming configuration.
- 8 Select the audio channels.
- 9 Depending on the resolution and frame rate, a screen may prompt you to change other settings. Change the settings as necessary.
- 10 Select [OK].
 - The function settings are saved to a [MODE] file.

- 11 Select the connection setting (SET1 to SET20) where to save the settings.
- 12 Select [OK].
 - The camera will connect to the network and will be ready to start streaming.
- 13 Connect the decoder to the network and complete any necessary configurations on the receiving side so the decoder is ready to receive video over IP.
 - To start streaming, refer to *IP Streaming* (📖 182).

Options for [Protocol]

- [UDP]: This protocol prioritizes transfer speeds but does not guarantee the reliability/integrity of the data. Lost or delayed IP packets are ignored.
- [RTP]: Standard protocol for video/audio broadcasts over the Internet. Lost or delayed IP packets are ignored.
- [RTP+FEC]: This setting uses the RTP protocol and adds a layer of FEC error correction so the receiving side* can recover lost or delayed IP packets.
- [RTSP+RTP]: This setting uses the RTSP (real time streaming) protocol to control the streaming server (camera) in real time and the RTP protocol for the broadcast over IP. With the RTSP protocol, the receiver can control when to start and stop the broadcast.
- [SRT]: A protocol for high-speed transmission that suppresses the occurrence of lost/delayed packets. Transmitted data can be encrypted.

* A decoder compatible with FEC error correction is required.

Browser Remote

This section continues the connection settings wizard (📖 167). A user name and password are required to log in to the Browser Remote application. In the function settings you will configure up to three different users for single-user or two-user operation.

- 1 Select [Create New Func. Setting].
 - Once you have added multiple function settings, you can select [Select Existing Setting] to reuse Browser Remote settings that you saved previously.
- 2 Enter the user names and passwords as necessary.
- 3 Select [OK] twice.
 - The function settings are saved to a [MODE] file.
- 4 Select the connection setting (SET1 to SET20) where to save the settings.
- 5 Select [OK].
 - The camera will connect to the network and will be ready to accept commands from the Browser Remote application (📖 184).

Canon App (Connecting to a Smartphone)

This section details the necessary settings to connect the camera to a smartphone through a network. Be sure to connect both the smartphone and the camera to the same network in advance.

A Content Transfer Mobile is necessary to connect the camera to a smartphone. For details on downloading the necessary Content Transfer Mobile, refer to *Transferring Recordings to a Smartphone* (📖 194). For more details, refer to the smartphone's instruction manual.

- 1 Select [Create New Func. Setting].
 - Once you have added multiple function settings, you can select [Select Existing Setting] to reuse Canon App settings that you saved previously.
- 2 Select [OK].
- 3 As indicated on the screen, open the application on the smartphone.
- 4 Select the camera using the Content Transfer Mobile.

- If the camera and the smartphone are connected to the same network, the camera will be detected automatically.
- 5 Select [OK].
 - The connection will be completed.
 - The function settings are saved to a [MODE] file.
 - 6 Select the connection setting (SET1 to SET20) where to save the settings.
 - 7 Select [OK].
 - The connection will be completed and the camera will be ready to operate with the connected smartphone (📖 194).

XC Protocol

Set a user name and password to connect to an XC Protocol compatible device connected to a network.

- 1 Select [Create New Func. Setting].
- 2 Set the authentication method used by the XC Protocol (HTTP) server.
 - After selecting [Basic Authentication] or [Digest Authentication], set the user name and password.
User name: 5 to 15 alphanumeric characters or symbols.
Password: 8 to 32 alphanumeric characters or symbols (use at least 2 types from each).
- 3 Select [OK].
 - The function settings are saved to a [MODE] file.
- 4 Select the connection setting (SET1 to SET20) where to save the settings.
- 5 When the confirmation message appears, press SET.
 - The camera will connect to the network and will be ready to accept commands from the remote controller/application (📖 191).

Other Connection Methods

This section explains how to configure communication settings using methods other than the WPS push button.

Ethernet Settings

- 1 In the [Network Type] screen, select [Ethernet 📶].
- 2 Make sure the Ethernet cable is correctly connected (📖 165) and select [Setup with Network Connection].
 - Select [Setup without Network Connection] to only configure the settings, without connecting to the network.
- 3 Set the IP address (📖 174).
- 4 Select [OK] to continue to configure the function settings.
 - The communication settings are saved to an [NW] file.
 - Continue with one the following procedures to configure the selected function's settings.
FTP transfer (📖 167), IP streaming (📖 169), Browser Remote (📖 170), XC Protocol (📖 171)

Camera Access Point

Connect a network device with the camera's access point. Two configuration methods are available: easy connection and manual connection.

- 1 In the [Select a network] screen, select [Camera Access Point Mode].
- 2 Select the configuration method.
 - Depending on the selected method, perform either step 3 or steps 3-7 and then continue to step 8.

[Easy Connection]

3 The camera will assign the network name (SSID) and password automatically. Review the settings for the camera's Wi-Fi access point and select [OK].

- These settings are necessary to connect a network device to the camera.
- QR code connection is also possible. Touch [QR] on the screen to display a QR code to be read with a network device.

[Manual Connection]

3 Enter the SSID (network name) for the Camera Access Point and then select [OK].

- Enter the desired network name using the keyboard screen (☞ 27).

4 Select the Wi-Fi channel.

- Select [Automatic Setting] to have the camera select the channel automatically, or select [Manual Setting] > Desired channel.

5 Select the encryption settings.

- Select [AES] to use AES encryption, or [Disable] to use no encryption.
- If you selected [Disable], skip to step 7.

6 Enter the password for the Camera Access Point and then select [OK].

- Enter the desired password using the keyboard screen (☞ 27).

7 Set the IP address (☞ 174).

Both configuration methods

8 Select [OK] to continue to configure the function settings.

- The communication settings are saved to an [NW] file.
- Continue with one the following procedures to configure the selected function's settings. FTP transfer (☞ 167), Browser Remote (☞ 170), XC Protocol (☞ 171)

9 Before you can save the connection setting, connect the network device to the camera.

- Activate the device's Wi-Fi function, select the camera's SSID (network name) from the list and enter the password to connect to the camera.

WPS using a PIN Code

Connect to an access point using a PIN code. For most wireless routers, you must use a Web browser to access the setup screen. For details on how to set up the access point, refer to the access point's user manual.

1 In the [Select a network] screen, select [Connect with WPS] > [WPS (PIN Code)].

- The camera will generate and display an 8-digit PIN code.

2 Enter the PIN code into the wireless router's WPS (PIN code) setup screen and then, on the camera, select [OK].

3 Set the IP address (☞ 174).

4 Select [OK] to continue to configure the function settings.

- The communication settings are saved to an [NW] file.
- Continue with one the following procedures to configure the selected function's settings. FTP transfer (☞ 167), IP streaming (☞ 169), Browser Remote (☞ 170), Canon App (☞ 170), XC Protocol (☞ 171)

Detected Access Points

The camera will automatically detect access points in the vicinity. After you select the desired access point, you only need to enter the selected network's password to connect the camera. Be sure to activate tethering in advance when using a smartphone as an access point. For details about the access point's network name (SSID) and password refer to the wireless router's instruction manual or consult the network administrator in charge of the access point.

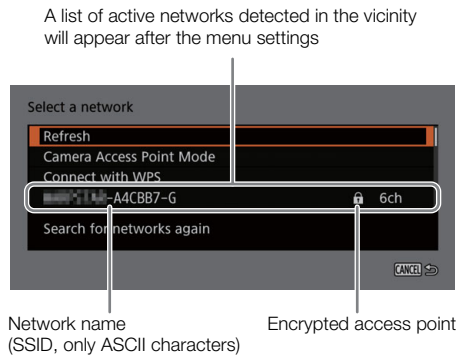

- 1 In the [Select a network] screen, scroll through the list of detected networks and select the desired network.
 - If the access point is encrypted, enter the password of the access point using the keyboard screen (27).
- 2 Set the IP address (174).
- 3 Select [OK] to continue to configure the function settings.
 - The communication settings are saved to an [NW] file.
 - Continue with one the following procedures to configure the selected function's settings.
 - FTP transfer (167), IP streaming (169), Browser Remote (170), Canon App (170), XC Protocol (171)

SSID/Authentication Mode Input

You can connect to a specific access point by manually entering its details. For details about the access point's network name (SSID) and password refer to the wireless router's instruction manual or consult the network administrator in charge of the access point.

- 1 In the [Select a network] screen, select [Enter SSID/Authentication Method].
- 2 Enter the SSID (network name) of the desired network and then select [OK].
 - Enter the desired network name using the keyboard screen (27).
- 3 Select the network's authentication method.
 - If you select [Open System], select [Disable] (no encryption) and skip to step 6, or select [WEP] and continue the procedure.
 - If you select [Shared Key] or [Open System] > [WEP], select the key index.
- 4 Enter the password of the desired network and then select [OK].
 - Enter the desired password using the keyboard screen (27).
- 5 Set the IP address (174).
- 6 Select [OK] to continue to configure the function settings.
 - The communication settings are saved to an [NW] file.
 - Continue with one the following procedures to configure the selected function's settings.
 - FTP transfer (167), IP streaming (169), Browser Remote (170), Canon App (170), XC Protocol (171)

Offline Configuration without Connecting to a Network

1 In the [Select a network] screen, select [Configure Offline].

2 Select the network type.

- If you select [Infrastructure], continue with the procedure to enter the SSID and authentication mode, from step 2 (📖 173).
- If you select [Camera Access Point Mode], continue from that procedure, from step 2 (📖 171).

Configuring the Camera's IP Address

This section explains how to configure the IP address. Available settings will change depending on the network function selected.

1 Select the method used to configure IPv4 settings, [Automatic Setting] or [Manual Setting].

- When using the wizard to add a new connection setting, make the selection in the [IP Address Settings (IPv4)] screen.
- If you select [Automatic Setting], skip to step 4.

[Manual Setting]

2 Select [IP Address] and [Subnet Mask] and enter the desired addresses using the data entry screen (📖 27).

- To use a default gateway, select [Use Gateway] > [Enable] and then select [Gateway] and enter the address.
- To use a DNS address, select [Use DNS Address] > [Manual Setting] and enter the address.

3 Select [OK].

Both methods

4 Select whether to use TCP/IPv6 settings or not.

- To use IPv4 settings, select [Disable].
- To configure IPv6 settings (📖 177).

Other Network Settings

Reading/Deleting a Root Certificate for FTP Transfer

When you use the [FTPS] transfer mode, you will need to read onto the camera the same root certificate saved on the FTP server. You can also check the content of a previously loaded root certificate or delete it.

1 Set the camera to MEDIA mode.

2 Save the desired root certificate file onto the root directory of a card and insert it into card slot B.

3 Select **MENU** >  Network Settings] > [Advanced Settings] > [FTP Transfer Settings] > [Read Root Certificate] > [OK].

- The root certificate file is read from the card.
- After reading a root certificate file, you can select [Root Certificate Details] to check the certificate's issuer and expiration date, or select [Delete Root Certificate] to delete the root certificate in the camera.

NOTES

- Only one root certificate, with one of the following file names, can be read by the camera: "ROOT.CER", "ROOT.CRT" and "ROOT.PEM".
- If you transfer files using FTPS transfer with a self-signed certificate, you may not be able to trust the destination server.

802.1X Authentication

The camera is compatible with the following protocols.

EAP-TLS: X.509 supported

EAP-TTLS, PEAP: MS-CHAP v.2 supported

Select **MENU** > [ Network Settings] > [Advanced Settings] > [802.1X Authentication] > [Setup Wizard].

- Follow the wizard to complete the authentication settings.
When you select the [EAP-TLS] protocol, the root certificate, client certificate and private key will be read from the card.
When you select the [EAP-TTLS] or [PEAP] protocol, select [User Name] and [Password] and enter the information using the keyboard screen ( 27). Then, read the root certificate from the card.
- After reading the authentication files, select [Check Settings] to check their content. Select [Delete Settings] to delete the authentication files in the camera.

Giving a Nickname to the Camera

You can give the camera a nickname that is used on network connections and network devices to make it easier to identify.

Select **MENU** > [ Network Settings] > [Nickname].

- Enter the desired nickname using the keyboard screen ( 27).

Checking and Changing Connection Settings (SET)



You can check and, if necessary, change the settings of connection settings (SET) registered in the camera. In addition to deleting and renaming connection settings, you can also add to a connection setting a secondary network or second function.

Checking the Content of a Connection Setting

Select **MENU** > [ Network Settings] > [Connection Setting] > Desired connection setting ([SET1] to [SET20]) > [Check Settings].

- The detailed content of the connection setting is displayed.
- Push the joystick left/right to review all the settings and press the CANCEL button to return to the menu.

Changing Settings using the Wizard

- 1 Select **MENU** > [ Network Settings] > [Connection Setting] > Desired connection setting ([SET1] to [SET20]) > [Change with Wizard].
- 2 Select the desired network function and then follow the wizard as described in the previous procedure (from step 3,  167) and make any changes as necessary.

Changing Connection Settings using Existing Settings

You can use previously registered communication settings ([NW] files) or function settings ([MODE] files) to easily replace the content of a connection setting or to add a second network or network function in addition to those registered using the wizard.

- 1 Select **MENU** > [ Network Settings] > [Connection Setting] > Desired connection setting ([SET1] to [SET20]) > [Select Existing Setting].

To add/replace a communication or function setting

- 2 Select the setting you want to change > [Select Existing Setting] > Desired NW or MODE file.
 - In the list of communication settings and function settings registered in the camera, only those that can be selected will be displayed in white and others will be grayed out.
- 3 Select [Set].
 - If necessary, select [Check Comm. Settings] or [Check Function Settings] to check the content of the selected file before making the change.

To delete a communication or function setting



- 2 Select the setting you want to remove > [Clear Selected] > [OK].

NOTES

- A connection setting can have two communication settings (primary/secondary network) and up to two function settings (only for [IP Streaming] and [Browser Remote]).
- If both communication settings are deleted, the connection setting itself will be reset and will appear as [Unspecified].

Renaming Connection Settings

You can rename connection setting (SET) files to make them easier to identify from the list.

- Select **MENU** > [ Network Settings] > [Connection Setting] > Desired connection setting ([SET1] to [SET20]) > [Settings Name].
- Enter the desired name (up to 12 characters) using the keyboard screen ( 27).

Deleting Connection Settings

- Select **MENU** > [ Network Settings] > [Connection Setting] > Desired connection setting ([SET1] to [SET20]) > [Delete Settings] > [OK].
- The connection setting will be deleted.

NOTES

- Even if you delete a connection setting, the individual communication/function settings stored in it are not deleted. You can reuse these settings to configure other connection settings.



Checking and Changing Communication Settings (NW)/Function Settings (MODE)

You can check the content of communication settings ([NW] files) and function settings ([MODE] files) saved in the camera and change or delete them as necessary.

Checking the Content of a Communication Setting/Function Setting

- 1 Select **MENU** > [ Network Settings] > [Advanced Settings] > [Communication Settings] or [Function Settings].
- 2 Select the desired communication setting ([NW1] to [NW25]) or function setting ([MODE1] to [MODE25]).
- 3 Select [Check Settings].
 - The detailed content of the selected setting is displayed.
 - Push the joystick left/right to review all the settings and press the CANCEL button to return to the menu.

Changing/Deleting Communication Settings/Function Settings

- 1 Select **MENU** > [ Network Settings] > [Advanced Settings] > [Communication Settings] or [Function Settings].
- 2 Select the desired communication setting ([NW1] to [NW25]) or function setting ([MODE1] to [MODE25]).
- 3 Select [Change Settings] and change the various settings as necessary.
 - If in step 2 you selected an [Unspecified] settings file, the only option available is [Create New with Wizard] ( 167).
 - Select [Delete Settings] > [OK] to delete the communication setting/function setting.

Configuring TCP/IPv6 Settings

If in the wizard you selected [Enable] to use IPv6 settings, change the settings as necessary after completing the wizard.

- 1 After step 3 in the previous procedure, select [TCP/IPv6] > [TCP/IPv6 Settings] > [Enable].
 - This step is not necessary if you selected [Enable] when you used the wizard to add a new connection setting.
 - Continue the procedure to change the default IPv6 settings.
- 2 To configure the IPv6 settings manually, select [Manual Setting] > [Enable].
 - [DNS Server] changes to [Manual Setting].
- 3 Select [DNS Server] > Desired option.
 - If you selected [Disable] in step 2, you can set [DNS Server] to [Auto Assign].
 - When not using a DNS server, select [Disable].
- 4 If you set [DNS Server] to [Manual Setting] in step 3, configure the [DNS Address].
 - Enter the IP address using the data entry screen ( 27).

When [Manual Setting] is set to [Enable]

- 5 Select [Manual Address] (manually entered IPv6 address), [Prefix Length] (bits available for the network address) and [Gateway] (gateway's IP address) and enter the necessary information.
 - Enter the IP addresses and prefix length using the data entry screen ( 27).

Individual settings available for manual change (communication settings)

Menu item	Setting options and additional information
[Wi-Fi]	
[SSID]	–
[Advanced Settings]	[Authentication Method], [Password]
[TCP/IPv4]	
[IP Address Settings]*	[Automatic Setting], [Manual Setting]
[DNS Server]	[Disable], [Auto Assign], [Manual Setting]
[DNS Address]*, [IP Address]*, [Subnet Mask]*, [Gateway]*	
[TCP/IPv6]	
[TCP/IPv6 Settings]*	[Disable], [Enable]
[Manual Setting]	[Disable], [Enable]
[DNS Server]	[Disable], [Auto Assign], [Manual Setting]
[DNS Address], [Manual Address], [Prefix Length], [Gateway]	Enter the desired address using the data entry screen ( 27).

Individual settings available for manual change (function settings)

Menu item	Setting options and additional information
[FTP Transfer]	
[Destination Server]	
[Server]*, [Port No.]*	
[User Name/Password]	
[User Name]*, [Password]*	
[Destination Folder]*	
[Dest. Folder Structure]	[Default], [Camera]
[Overwrite Files]	[Skip], [Save As (New Name)], [Overwrite] Determines how to deal with files to be transferred when files with the same name already exists in the destination folder. [Skip]: The file will not be transferred. [Save As (New Name)]: The file will be transferred and “_1” will be added to the end of the file name. [Overwrite]: The file will be transferred, overwriting any file with the same name on the FTP server.
[Passive Mode]*	[Disable], [Enable]
[New Folder by Date]	[Enable], [Disable] [Enable]: A new subfolder under the transfer destination folder “YYYYMMDD\HHMMSS” will be created for every transfer operation. [Disable]: All the files will be transferred to the folder specified for the [Destination Folder] setting.
[IP Streaming]	
[Protocol]*	[UDP], [RTP], [RTP+FEC], [RTSP+RTP], [SRT]
[Destination Server]*, [Dest. Port No.]*, [FEC Port No.]*	
[FEC Interval]	10 to 100 (intervals of 5)
[RTSP: User Name]*, [RTSP: Password]*	
[SRT: Connection Mode]	[Caller], [Listener]
[SRT: Stream ID]	
[SRT: Listening Port No.]	
[SRT: Encryption Settings]	[Disable], [AES-128], [AES-192], [AES-256]
[SRT: Passphrase]	
[SRT: Latency]	
[Video Output Conf.]*	[9Mbps/1920x1080 59.94P], [4Mbps/1920x1080 59.94P], [9Mbps/1920x1080 50.00P], [4Mbps/1920x1080 50.00P], [9Mbps/1920x1080 59.94i], [4Mbps/1920x1080 59.94i], [9Mbps/1920x1080 50.00i], [4Mbps/1920x1080 50.00i],
[Audio Out Channels]*	[CH1/CH2], [CH3/CH4]

* Change these settings as explained in the wizard (📖 167).

Changing Browser Remote Settings

- 1 Select **MENU** > [📶 Network Settings] > [Advanced Settings] > [Browser Remote Settings].

2 Change the various settings as necessary.

- You can select [Port No. (HTTP)] or [Port No. (HTTPS)] to change the port numbers used for each connection. Using the default port numbers (HTTP: 80, HTTPS: 443) is recommended.
- To use an HTTPS connection, select [HTTPS] > [Enable].

To use a secure HTTPS connection, use a Camera Access Point connection setting and connect the network device to the camera using a normal HTTP connection (📖 184) and download the necessary certificate from the Browser Remote's settings tab (📖 190). After you import the certificate you downloaded to your Web browser, you will be able to use a secure HTTPS connection.

To change XC Protocol settings

1 Select **MENU** > [ Network Settings] > [Advanced Settings] > [XC Protocol Settings].

2 Change the various settings as necessary.

- You can select [Port No. (HTTP)] to change the port number used for connection. Using the default port number (HTTP: 80) is recommended.

Checking the Network's Status

Unless you selected to configure a connection setting offline (without connecting to the network), immediately after configuring a new connection setting, the camera will connect to the network automatically and the selected function settings will be activated. The icons displayed on the screen will indicate the type of network selected and the connection status. When you disable the network functions or disconnect from the network, the icons will disappear.

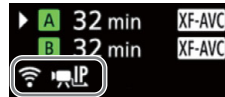

Network connection icons

 Wi-Fi (Infrastructure):

In yellow – the camera is connecting to or disconnecting from the network. In white – the network function can be used.

 Wi-Fi (Camera Access Point):

In yellow – starting the camera's access point. In white – the camera's access point is ready. Connect the Wi-Fi enabled device to the camera.

 Ethernet:

In yellow – the camera is connecting to or disconnecting from the network. In white – the network function can be used.

Network function icons

 FTP: FTP file transfer ( 181)

 IP: IP streaming ( 182)

FTP File Transfer

In MEDIA mode, you can transfer clips from the camera to another device connected to the network, using the FTP protocol.

The following explanations assume that the FTP server is on, ready and correctly configured.

Transferring a Single Clip

- 1 Connect the camera to the desired network and activate the network functions (📖 166).
 - Select a connection setting with the [FTP Transfer] function setting.
- 2 Select the desired clip in the [XF-AVC] or [MP4] index screen (📖 135).
- 3 Press SET to open the file menu and select [FTP Transfer] > [OK].
 - The camera will connect to the FTP server and the file will be transferred.
 - Select [Cancel] to interrupt the file transfer in progress.

Transferring All Clips

- 1 Connect the camera to the desired network and activate the network functions (📖 166).
 - Select a connection setting with the [FTP Transfer] function setting.
- 2 Open the [XF-AVC] or [MP4] index screen (📖 135).
- 3 Select **MENU** > [ Network Settings] > [FTP Transfer All Clips] > [OK].
 - The camera will connect to the FTP server and all the files will be transferred.
 - Select [Cancel] to interrupt the file transfer in progress.

IMPORTANT

- Observe the following precautions when transferring files. Failing to do so may interrupt the transfer and incomplete files may remain at the transfer destination.
 - Do not open the card compartment cover.
 - Do not remove the power source or turn off the camera.
- If incomplete files remain at the transfer destination, check the content and make sure they are safe to delete before deleting them.

NOTES

- Depending on the access point's settings and capabilities, it may take some time to transfer files.

IP Streaming

In CAMERA mode, you can stream the camera's live video and audio over IP to a compatible IP video decoder* connected to the network. You can use IP streaming for live broadcasts or to send video reports from a location with poor network connectivity.

* This can be a dedicated video transfer device or decoder software on a computer. For details about compatible decoders, please visit your local Canon website.

Configuration of video streamed over IP

Main recording video configuration			Streamed video configuration					
Video format	Resolution	Frame rate	Video			Audio		
			Bit rate	Resolution	Frame rate	Audio format	Bit rate	
XF-AVC, MP4 (H.264)	3840x2160, 1920x1080	59.94P	9 Mbps, 4 Mbps	1920x1080	59.94P, 59.94i		MPEG-2 AAC 2 channels*	256 Kbps
		59.94i			59.94i			
		50.00P			50.00P, 50.00i			
		50.00i			50.00i			

* When the audio of the primary clip uses 4 channels, you can select which channels to stream over IP.

1 On the receiver's side: Connect the decoder to the network and complete any necessary configurations so it is ready to receive video over IP.

- For details refer to the instruction manual of the decoder device or software you will use.

2 On the camera: Connect the camera to the desired network and activate the network functions (☞ 166).

- Select a connection setting with the [IP Streaming] function setting.

3 Select **MENU** > [Network Settings] > [Activate IP Streaming] > [Enable].

- The camera will start streaming video over the selected network.
- You can press the REC button to simultaneously record the same image in the camera.

4 On the receiver's side: Connect to the camera.

When the streaming protocol is [RTSP+RTP], access the following URL and log in using the RTSP user name and password (☞ 169).

rtsp://xxx.xxx.xxx.xxx/stream
Camera's IP address

When the streaming protocol is [SRT] and the connection mode is [Listener], access the following URL.

srt://xxx.xxx.xxx.xxx/xxx...
Camera's IP address Listener port number

- If the data to be transmitted is encrypted, enter the SRT passphrase.

5 On the camera: To end the streaming, select **MENU** > [Network Settings] > [Activate IP Streaming] > [Disable].

IMPORTANT

- Streamed data is not encrypted (except when encrypted with SRT protocol).

NOTES

- Except when the streaming protocol is [RTSP+RTP], once IP streaming is activated, the camera will continue to broadcast video and audio data over the network, regardless of the status of the receiver. Be careful to set up the correct IP address and test in advance that the receiving decoder can indeed receive the signals.

- Depending on the network used and the connection conditions, you may experience lost or delayed IP packets.
- After streaming continuously for 24 hours, the camera will stop the IP streaming momentarily and then restart it automatically.
- When using IP streaming together with the Browser Remote function, you may experience stuttering issues in the streamed video or audio. When the two functions are used simultaneously, it is recommended not to log out from/reconnect to Browser Remote.
- Opening the card compartment cover and removing a card while IP streaming is activated may cause brief stops in the streamed video and audio.
- IP streaming cannot be used in the following cases:
 - When using a recording mode other than [Normal Recording].
 - When [2nd Card Rec Functions] is set to an option other than [Off].
 - When using the web camera function (📖 117).

Browser Remote: Controlling the Camera from a Network Device

In CAMERA mode, you can operate the camera remotely using Browser Remote, an application that can be accessed on a connected network device. Using Browser Remote you can check the camera's live image and control various recording settings*. You can also check other important indications, such as remaining recording time on the card, remaining battery charge/power source details, time code, etc.

* White balance, ISO speed/gain, shutter speed, ND filter, aperture, focus and zoom.

Starting Browser Remote

After connecting the camera to the network In CAMERA mode, you can start the Browser Remote application on the Web browser* of any network device** connected to the same network.

* A Web browser that supports JavaScript and is enabled to accept cookies is required.

** For details about compatible devices, operating systems, Web browsers, etc., please visit your local Canon website.

Preparations on the Camera

- 1 Connect the camera to the desired network and activate the network functions (📖 166).
 - Select a connection setting with the [Browser Remote] function setting.
- 2 Check the Browser Remote's URL in the [📶 Network Settings] status screen (📖 216).
 - When using IPv6 settings, check the camera's IP address instead (📖 215).
 - Write down the URL or IP address if necessary.

On the Network Device

- 1 Connect the network device to the camera or to the same access point as the camera.
- 2 Start the Web browser on the network device.
- 3 Enter Browser Remote's URL.
 - Enter the URL / IP address you checked previously into the Web browser's address bar as follows.

http://xxx.xxx.xxx.xxx:nnn

 Camera's IP address Port No. (can be omitted when using the default port no.)

- To use an HTTPS connection, enter "https:" instead of "http:".
- When using IPv6 settings, enter the camera's IPv6 IP address instead.

4 Enter the user name and password.

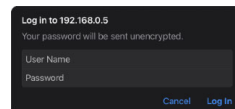

Example of the login screen. The screen may differ depending on the Web browser and version used.

- Be sure to log in with the user name and password of one of the users that were set on the camera (📖 170). If necessary, consult the administrator who configured the camera's settings.
 - The Browser Remote screen will appear. The screen displayed may be different depending on the user information used to log in.
- 5 To change the application's language, select [⋮] > [Language 🗨️] > Desired language.
- Most buttons and controls emulate physical controls on the camera and are labeled in English only, regardless of the language selected.

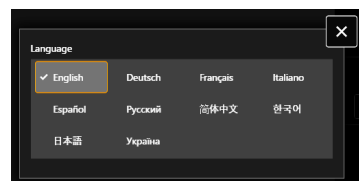

6 Use the Browser Remote controls to operate the camera.

- Descriptions of the controls are given in the following pages.

7 When you have finished using Browser Remote, select [⋮] > [Log Out] on the Browser Remote screen to end the application.

 NOTES

- Depending on the network used and the connection performance, you may notice delays in the refreshing of the live view image and other settings. If the delay is too long, changing the resolution of the live view image is recommended (📖 190).
- If Browser Remote is set to a language other than the language set on the network device, the application may not be displayed correctly.

Using Browser Remote

i NOTES

- Browser Remote does not support multi-touch gestures.

The Main Remote Operation Screen



- 1 Network connection indicator**
While Browser Remote is correctly connected to the camera, the dots will keep turning on and off in a loop.
- 2 Live view screen**
Shows the camera's live view image.
- 3 Recording operation (45) and recording command (199) (same as on the camera)**
- 4 Time code (same as on the camera)**
- 5 Add a shot mark**
- 6 Add a mark**
- 7 Add an mark**
- 8 Camera's nickname (175)**
- 9 [LIVE VIEW] button**
Touch the button to display the camera's live view image on the Browser Remote screen.
- 10 [Touch Focus] button**
Touch the button to unlock (enable) the touch focus mode.
- 11 IP streaming**
Available only when using a connection setting with both the [Browser Remote] and [IP Streaming] function settings.
- 12 [REC] button**
Touch the button to start recording. The recording operation indicator changes to **[●REC]** and the center of the button turns red.
The time code will advance while recording.
Touch the button again to stop recording. The recording operation indicator changes back to **[STBY]**.

13 Card selection and approximate remaining recording time

14 [SLOT SELECT] button

Touch to select the other card when both card slots contain a card.

15 Assignable buttons

16 Assignable functions check

17 Double slot recording

18 Remaining battery charge / Power supply level (🔋 45)

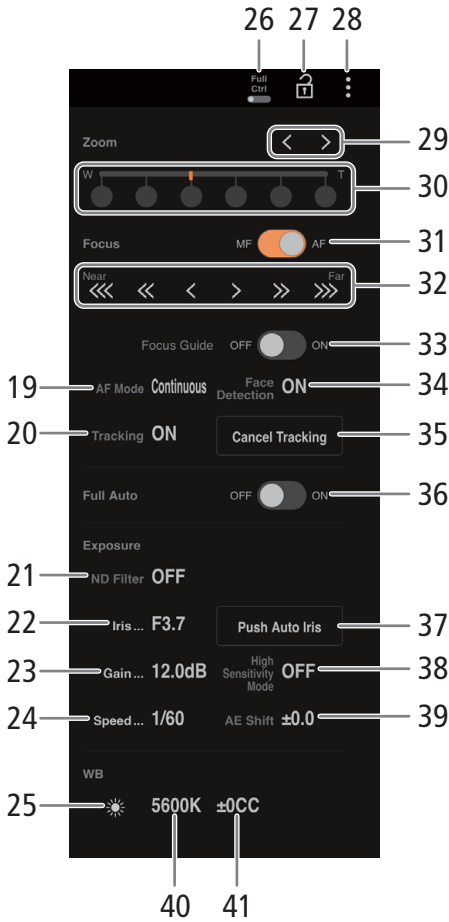

- 19 AF mode
Select the AF mode.
- 20 Tracking
- 21 ND filter
- 22 Aperture value
- 23 ISO speed/gain value
- 24 Shutter speed

25 White balance method selection

When the white balance mode is set to **[AWB]**, touch **[AWB Lock]** to lock the current white balance settings. Touch again to resume the automatic white balance (AWB).
When the white balance mode is set to **[A]** or **[B]**, touch **[A/B]** to register a custom white balance.

26 Full Ctrl (full controls) switch (189)

Detailed settings for AF operations, aperture, ISO speed/gain, AE operations and custom picture

27 Key lock button

Touch the icon to lock the Browser Remote screens in order to prevent settings from being changed inadvertently. Controls on the camera are not locked.

28 Browser Remote settings (190)

29 Manual zoom buttons

Touch to adjust the zoom. Hold **[<|>]** pressed down to continue zooming in/out.

30 Fixed zoom positions

Select one of the fixed zoom positions. When using a slow zoom speed, it may take some time until the lens start moving.

31 Focus mode switch

32 Manual focus controls

When **[Focus]** is active, touch **[<<<]**, **[<<]** or **[<]** to focus closer or **[>]**, **[>>]** or **[>>>]** to focus farther. There are three levels of adjustment - **[<|>]** is the smallest and **[<<<|>>>]** the largest. Keep touching the button (long press) for a continuous operation.

33 [Focus Guide] switch

Touch to display the focus guide (77).

34 [Face Detection] button (81)

35 [Cancel Tracking] button

36 Full auto switch (42)

37 [PUSH AUTO IRIS] button

38 High sensitivity mode

39 AE shift

40 Color temperature

41 Color compensation

Full Controls

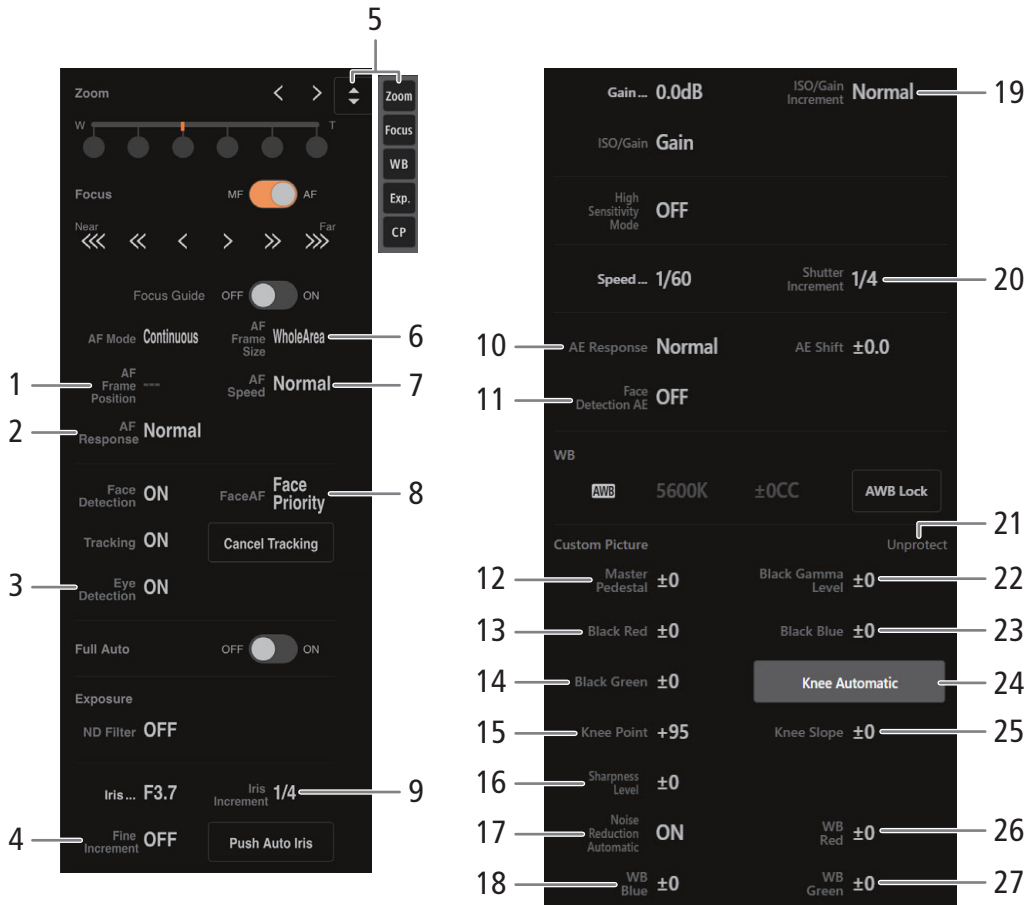

- | | |
|--|--|
| <ul style="list-style-type: none"> 1 AF frame position 2 AF response 3 Eye detection 4 Fine aperture adjustment 5 Function shortcut button
Displays the various adjustable functions. Touch the function you wish to adjust. 6 AF frame 7 AF speed 8 Face AF
Select the desired Face AF setting. 9 Aperture increment | <ul style="list-style-type: none"> 10 AE response 11 Face Detection AE 12 Master Pedestal 13 Black Red 14 Black Green 15 Knee Point 16 Sharpness Level 17 Noise Reduction Automatic 18 White Balance Blue 19 ISO/Gain increment 20 Shutter increment 21 Custom picture file protection status 22 Black Gamma Level 23 Black Blue 24 Knee Automatic 25 Knee Slope 26 White Balance Red 27 White Balance Green |
|--|--|

⋮ Browser Remote Settings Tab

1 Language selection

Changes the language used for controls in the [📄] (metadata input) screen and for error messages. Still, most of the application's controls emulate physical buttons on the camera and appear in English only, regardless of the language selected.

2 Display style

Touch to select the background color of the Browser Remote screens.

3 Secured connection

Touch to download the certificate required to use a secure HTTPS connection.

4 Live view resolution

Select [Large] (higher resolution) or [Small] (lower resolution) depending on the quality of the connection.

5 Log out

Touch to log out from the Browser Remote application.

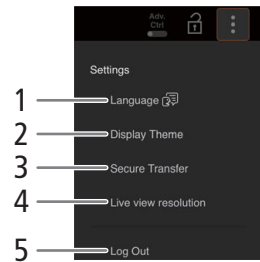

Recording Remotely Using an XC Protocol Compatible Controller/Application

Set the IP address of the camera on the optional XC Protocol compatible RC-IP100/RC-IP1000 Remote Camera Controller or Remote Camera Control Application¹ to control the camera remotely. Additionally, you can remotely operate the camera using Multi-Camera Control² from a smartphone connected to the same network as the camera.

¹ Available from your local Canon website.

² Available from the App Store.

1 In CAMERA mode, activate the network functions (📖 166)

- Select a connection setting with the [XC Protocol] function setting.

Recording remotely using the RC-IP100/RC-IP1000 Remote Camera Controller

You can remotely control camera settings like the aperture and shutter speed, or change picture related settings like the knee and sharpness. For more details on the connection, settings and the RC-IP100/RC-IP1000 refer to the RC-IP100/RC-IP1000 instruction manual.

NOTES

- When connected to the camera, the following functions of the RC-IP100 cannot be used.
 - **F1/F2 knob:** PT Speed, R Gain, B Gain, Noise Reduction.
 - **USER1/USER2 button:** One Shot AF, Preset Color Settings, Color Space.
 - **Control lever:** pan/tilt operations.
 - **TRACE tab.**
 - **FUNC tab:** Soft Zoom Control, PT Acceleration, ND Filter Mode, Infrared, Wiper, Washer, AUX1, AUX2, AUX3, AUX4, Enhanced ND Filter.
- The following RC-IP1000 buttons/levers/dials cannot be used when connected to the camera.
 - Camera settings area: ABB button.
 - Pan/tilt operation area: PAN/TILT lever, pan/tilt SPEED dial.
 - Iris/zoom/focus operation area: ONE-SHOT AF button.

You cannot use functions that are not supported by the camera. If you assign an unsupported function to the menu operation area, USER buttons area, F1/F2/F3/F4/F5 dials, or USER 1 to USER 10 buttons in the SYSTEM menu, it will be displayed in gray on the RC-IP1000's LCD panel.

- Even if the camera's controls are locked (key lock), you can use the RC-IP100/RC-IP1000 to operate the camera (📖 15).
- **About changing custom picture related settings using the optional RC-IP100/RC-IP1000 Remote Camera Controller**
 - If a protected custom picture file is selected on the camera, custom picture related settings cannot be changed using the remote camera controller or Remote Camera Control Application.
 - Adjusting custom picture related settings using the remote camera controller or Remote Camera Control Application will change the settings registered under the currently selected custom picture file. If you want to keep an important custom picture file, backup it or select in advance a custom picture file you do not mind changing.

Recording remotely using the Remote Camera Control Application

During recording, you can check the angle of view using Live View and adjust various picture related settings. For details about connection/setup and the Remote Camera Control Application, refer to the Remote Camera Control Application manual.

i NOTES

- The following functions are not available when operating the camera from the Remote Camera Control Application.

- Menu 

[Camera Power]

[Operational Settings]:

[Keyboard Shortcuts] > [Pan Left], [Pan Right], [Tilt Up], [Tilt Down], [Pan/Tilt Left and Up], [Pan/Tilt Right and Up], [Pan/Tilt Left and Down], [Pan/Tilt Right and Down], [Call Preset Home], [Pan/Tilt Speed +], [Pan/Tilt Speed -], [Prepare Trace], [Execute Trace]

[PTZ Direction Settings]

[Preset/Trace Settings]:

[Preset] > [Preset List] > [Preset Name], [Camera Settings]

[Trace]



[Camera Settings Page]

- Camera controls

[Basic] tab:

[PTZ/Focus] > [One Shot AF], [Pan/Tilt Speed], [Pan/Tilt]

[Preset] > [Speed Level], [Home]

[Exposure] > Modes other than  (full auto) and  (manual exposure).

[Exposure] > [ND filter] > [Auto]



[White Balance] > [R Gain], [B Gain]

[Trace]

[Details] tab:

[Exposure] > [Enhanced ND Filter]

[Other Functions] > [Wiper]

- Even when camera operation is disabled by key lock, operation is possible using the Remote Camera Control Application ( 15).
- When adjusting custom picture related settings, refer to *About changing custom picture related settings using the optional RC-IP100/RC-IP1000 Remote Camera Controller* ( 191).

Recording remotely using Multi-Camera Control

You can use a smartphone connected to the same network as the camera to remotely operate the camera and record video. During recording, you can check the angle of view using Live View and adjust various picture related settings.

1 Install Multi-Camera Control on your smartphone.

- Download and install Multi-Camera Control from the App Store.
- There is no need to repeat this step after the first time.

2 Connect the smartphone to the same network (access point) as the camera

- For details, refer to the smartphone's instruction manual.

3 Activate the desired network connection ( 166).

- Select a connection setting with the [XC Protocol] function setting.

4 Open Multi-Camera Control on the smartphone.**5 Operate the smartphone to connect to the camera.****6 Operate Multi-Camera Control on the smartphone to record remotely.**

7 When you finish the procedure, set **MENU** > [ Network Settings] > [Network] to [Disable].

- You can also set **MENU** > [ Network Settings] > [Connect] to [Disconnect].

 NOTES

- Even if the camera's controls are locked (key lock), you can use Multi-Camera Control to operate the camera ( 15).

Transferring Recordings to a Smartphone

You can transfer and save MP4 clips or proxy clips recorded with the camera, audio in WAV format and News Metadata files to a smartphone (connected to the same network as the camera) (📖 161).

1 Install Content Transfer Mobile on your smartphone.

- Download and install the Content Transfer Mobile from the App Store.
- There is no need to repeat this step after the first time.

2 Connect the smartphone to the same network (access point) as the camera.

- Be sure to activate tethering in advance when using a smartphone as an access point.
- For details, refer to the smartphone's instruction manual.

3 Activate the desired network connection (📖 166).

- Select a connection setting with the [Canon App] function setting.

4 As indicated on the screen, open the application on the smartphone.

5 Operate the smartphone to connect to the camera.

6 Select [OK].

7 Using the Content Transfer Mobile, transfer recordings from the camera.

8 When you finish the procedure, set **MENU** > [ Network Settings] > [Network] to [Disable].

- You can also set **MENU** > [ Network Settings] > [Connect] to [Disconnect].
- When you end the connection from the smartphone, **MENU** > [ Network Settings] > [Network] will be set to [Disable].

 NOTES

- When setting up a connection with the [Canon App] function setting using the GP-E2 GPS Receiver, connect the receiver to the multi-function shoe.

Menu Options

For details about how to select an item, refer to *Using the Menus* (📖 25). For details about each function, see the reference page or the explanation accompanying the menu entry. Setting options in boldface indicate default values.

Depending on the camera's operating mode and the settings, some menu items may not be available. Such menu items do not appear or appear grayed out in menu screens.

To skip directly to the page of a specific menu:

[📷 Camera Setup] menu	📖 195	[🛠 Assistance Functions] menu	📖 203
[🖼 Custom Picture] menu	📖 197	[🌐 Network Settings] menu	📖 205
[📹 Recording/Media Setup] menu	📖 197	[👤 Assignable Buttons] menu	📖 205
[🎵 Audio Setup] menu	📖 199	[⚙ System Setup] menu	📖 205
[📺 Monitoring Setup] menu	📖 200	[★ My Menu] customized menu	📖 207

[📷 Camera Setup] menu (CAMERA mode only)

Menu item	Setting options and additional information	
[Light Metering]	[Backlight], [Standard], [Spotlight]	(📖 67)
[AE Shift]	-2.0 to +2.0 in 0.25 point intervals (±0)	(📖 67)
[AE Response]	[High], [Normal], [Low]	(📖 65)
[Iris Increment]	[1/3 stop], [1/4 stop]	(📖 66)
[Fine Increment]	[On], [Off]	
[Iris Limit]	[On], [Off]	(📖 65)
[Iris Ring Direction]	[Reverse], [Normal]	(📖 66)
[Shutter Increment]	[1/3 stop], [1/4 stop]	(📖 60)
[ISO/Gain]	[ISO], [Gain]	(📖 62)
[Limit for Auto Mode]	When [ISO/Gain] is set to [ISO]: ISO 200 to [Off/ISO 12800] in 1/3 stop intervals When [ISO/Gain] is set to [Gain]: -6 dB to [Off/21.0 dB] in 1 dB intervals Available values may differ depending on the gamma settings.	(📖 62)
[ISO/Gain Increment]	[ISO]: [1 stop], [1/3 stop] [Gain]: [Normal], [Fine]	(📖 62)
[ISO/Gain L]	When [ISO/Gain] is set to [ISO]: [1 stop] ISO200 to ISO12800 in 1 stop intervals [1/3 stop] ISO200 to ISO12800 in 1/3 stop intervals When [ISO/Gain] is set to [Gain]: [Normal] -6.0 dB to 21.0 dB in 3 dB intervals ([0.0 dB]) [Fine] -6.0 dB to 21.0 dB in 0.5 dB intervals ([0.0 dB]) The initial values may differ depending on the gamma settings: [BT.709 Normal], [BT.709 Standard]: ISO200 ([1 stop] / [1/3 stop]) [PQ], [HLG]: ISO400 ([1 stop]), ISO320 ([1/3 stop]) [BT.709 Wide DR], [Canon Log 3], [Canon 709]: ISO800 ([1 stop]), ISO500 ([1/3 stop])	(📖 62)

Menu item	Setting options and additional information	
[ISO/Gain M]	When [ISO/Gain] is set to [ISO]: [1 stop] ISO200 to ISO12800 in 1 stop [1/3 stop] ISO200 to ISO12800 in 1/3 stop intervals When [ISO/Gain] is set to [Gain]: [Normal] -6.0 dB to 21.0 dB in 3 dB intervals ([6.0 dB]) [Fine] -6.0 dB to 21.0 dB in 0.5 dB intervals ([6.0 dB]) The initial values may differ depending on the gamma settings: [BT.709 Normal], [BT.709 Standard]: ISO400 ([1 stop] / [1/3 stop]) [PQ], [HLG]: ISO800 ([1 stop]), ISO640 ([1/3 stop]) [BT.709 Wide DR], [Canon Log 3], [Canon 709]: ISO1600 ([1 stop]), ISO1000 ([1/3 stop])	(62)
[ISO/Gain H]	When [ISO/Gain] is set to [ISO]: [1 stop] ISO200 to ISO12800 in 1 stop [1/3 stop] ISO200 to ISO12800 in 1/3 stop intervals When [ISO/Gain] is set to [Gain]: [Normal] -6.0 dB to 21.0 dB in 3 dB intervals ([12.0 dB]) [Fine] -6.0 dB to 21.0 dB in 0.5 dB intervals ([12.0 dB]) The initial values may differ depending on the gamma settings: [BT.709 Normal], [BT.709 Standard]: ISO800 ([1 stop] / [1/3 stop]) [PQ], [HLG]: ISO1600 ([1 stop]), ISO1250 ([1/3 stop]) [BT.709 Wide DR], [Canon Log 3], [Canon 709]: ISO3200 ([1 stop]), ISO2000 ([1/3 stop])	(62)
[Shockless Gain]	[High], [Normal], [Low], [Off]	
[High Sensitivity Mode]	[On], [Off]	(63)
[White Balance: PRESET]	[☀ Daylight] , [☀ Tungsten], [K Kelvin]	(68)
[Shockless WB]	[On], [Off]	(68)
[AWB Response]	[High], [Normal] , [Low]	(69)
[C. Temp. Increment]	[Mired] , [Kelvin]	(68)
[AF Mode]	[AF-Boosted MF], [Continuous]	(76)
[AF Frame]	[Whole Area] , [Large], [Small]	(81)
[AF Frame Position]	[Selectable] , [Center Frame]	
[AF Speed]	[High], [Normal] , [Low]	(80)
[AF Response]	[High], [Normal] , [Low]	
[Face Det. & Tracking]	[On] , [Off]	(81)
[Face Detection AE]	[On], [Off]	
[Face AF]	[Face Priority] , [Face Only]	
[Eye Detection]	[On], [Off]	
[Focus Limit]	[On], [Off]	(83)
[Focus Ring Direction]	[Reverse], [Normal]	(76)
[Focus Ring Response]	[High], [Normal] , [Low]	
[Zoom Speed Level]	[High], [Normal] , [Low]	
[High-Speed Zoom]	[On], [Off]	(73)
[Digital Zoom]	[Tele-converter 6.0x], [Tele-converter 3.0x], [Tele-converter 1.5x], [Digital 300x], [Advanced 30x], [Off]	(71)
[Handle Zoom Speed]	[Off], [1] to [16]	(74)
[Grip Zoom Speed]	[Constant], [Variable] , [User Setting]	(73)
[Constant Speed]	[1] to [16] ([8])	
[User Setting]	[User 1] to [User 3]	
[Color Bars]	[On], [Off]	(102)
[Color Bar Type]	[SMPTE] , [EBU] ¹ , [ARIB]	
[Flicker Reduction]	[Automatic], [Off]	(61)

Menu item	Setting options and additional information
[Conversion Lens]	[TL-U58], [WA-U58], [Off] (75)
[Diffraction Correction]	[On], [Off] (29) Corrects the lack of sharpness on the image that may be caused at certain apertures.
[IS Mode]	[Dynamic], [Standard] (84)
[Image Stabilizer]	[On] , [Off]
[Powered IS]	[On], [Off]
[IR Rec Color]	[White] , [Green] (114)
[IR Light]	[Toggle] , [Always On], [Always Off]
[IR Slow Shutter]	[On], [Off]

¹ The default value depends on the country/region of purchase.

[**CP** Custom Picture] menu (CAMERA mode only)

Menu item	Setting options and additional information
[Select CP File]	[C1:BT.709 Normal] , [C2:BT.709 Wide DR], [C3:BT.709 Standard], [C4:Canon Log 3], [C5:PQ], [C6:HLG], [C7:EOS Standard], [C8:EOS Neutral], [C9:Canon 709], [C10:User10] to [C20:User20] (124)
[Edit CP File]	
[Rename]	– (125)
[Protect]	[Unprotect], [Protect]
[Reset]	[BT.709 Normal] , [BT.709 Wide DR], [BT.709 Standard], [Canon Log 3], [PQ], [HLG], [EOS Standard], [EOS Neutral], [Canon 709], [USER (BT.709 Normal)]
Detailed custom picture settings	Refer to the tables in the <i>Available Custom Picture Settings</i> section. (128)
[Save CP File]	(127)
[Copy to SD Card B], [Load from SD Card B]	–

[**REC** Recording/Media Setup] menu

Menu item	Setting options and additional information
[Initialize Media]	[SD Card A], [SD Card B] (32)
[System Frequency]	[59.94 Hz] , [50.00 Hz] ¹ (54)
[Main Rec Format]	[XF-AVC YCC422 10 bit] , [MP4(HEVC) YCC422 10 bit], [MP4(HEVC) YCC420 10 bit], [MP4(H.264) YCC420 8 bit] (54)
[Main Resolution]	XF-AVC: [3840x2160 Intra-frame], [3840x2160 Long GOP] , [1920x1080 Intra-frame], [1920x1080 Long GOP], [1280x720 Long GOP] (54) MP4: [3840x2160] , [1920x1080], [1280x720]
[Frame Rate]	When [System Frequency] is set to [59.94 Hz]: [59.94i]*, [59.94P] ¹ , [29.97P], [23.98P] (54) When [System Frequency] is set to [50.00 Hz]: [50.00i]*, [50.00P] ¹ , [25.00P] * XF-AVC clips only. Not available when slow & fast motion recording is activated.
	Available options vary depending on the main resolution.

Menu item	Setting options and additional information	
[Bit Rate]	[410Mbps] , [300Mbps], [250Mbps], [240Mbps], [50Mbps], [25Mbps] Available values may differ depending on the [Main Resolution] and [Frame Rate] settings.	(54)
[Main Audio Format (MP4)]	[AAC 16 bit 2CH] , [LPCM 16 bit 4CH]	(95)
[Recording Mode]	[Normal Recording] , [Slow & Fast Motion], [S&F Clip / Audio (WAV)], [Pre-Recording], [A]Main / [B]Continuous Rec, [Frame Recording], [Interval Recording]	(35, 109)
[Slow & Fast Frame Rate]	Available options and default value vary depending on other settings. See the tables on the reference page.	(109)
[Continuous Recording]	[REC] , [STBY]	(113)
[Frame Rec: Frame Rate]	[1] , [3], [6], [9]	(111)
[Interval Rec: Time Interval]	[1 sec] , [2 sec], [3 sec], [5 sec], [10 sec], [15 sec], [30 sec], [1 min], [2 min], [3 min], [5 min], [10 min]	(112)
[Interval Rec: Frame Rate]	[1] , [3], [6], [9]	
[2nd Card Rec Functions]	[Off] , [A]Main / [B]Proxy Rec, [A]Main / [B]Sub Rec, [A]Main / [B]Audio Rec, [Relay Recording], [Double Slot Recording], [A]Main / [B]Chunk Rec	(35)
[B]Rec Format]	[XF-AVC YCC422 10 bit], [XF-AVC YCC420 8 bit], [MP4(HEVC) YCC422 10 bit], [MP4(HEVC) YCC420 10 bit], [MP4(H.264) YCC420 8 bit] Available options vary depending on the main recording format and the second card recording functions.	(55, 58)
[B]Resolution/Bit Rate]	Main recording: XF-AVC [XF-AVC YCC422 10 bit]: [3840x2160 Intra-frame], [3840x2160 Long GOP], [1920x1080 Intra-frame], [1920x1080 Long GOP], [1280x720 Long GOP], [1920x1080 50Mbps L.GOP], [1280x720 24Mbps L.GOP] Main recording: XF-AVC [XF-AVC YCC420 8 bit]: [1920x1080 35Mbps L.GOP], [1280x720 24Mbps L.GOP], [1280x720 17Mbps L.GOP] Main recording: XF-AVC [MP4(H.264) YCC420 8 bit]: [3840x2160], [1920x1080], [1280x720], [1920x1080 35Mbps], [1920x1080 16Mbps], [1920x1080 9Mbps], [1280x720 9Mbps], [1280x720 8Mbps], [1280x720 6Mbps], [1280x720 4Mbps] Main recording: MP4 [MP4(HEVC) YCC422 10 bit]: [1920x1080], [1280x720], [1920x1080 50Mbps], [1280x720 12Mbps] Main recording: MP4 [MP4(HEVC) YCC420 10 bit]: [1920x1080], [1280x720], [1920x1080 35Mbps], [1280x720 9Mbps] Main recording: MP4 [MP4(H.264) YCC420 8 bit]: [1920x1080], [1280x720], [1920x1080 35Mbps], [1920x1080 9Mbps], [1280x720 9Mbps], [1280x720 8Mbps], [1280x720 6Mbps], [1280x720 4Mbps] Available options vary depending on the main recording format, the second card recording functions and the B recording format.	(55, 58)
[B] Frame Rate]	[Same as Main Recording] , [59.94i], [50.00i]	(58)
[B]Audio Format (MP4)]	[AAC 16 bit 2CH] , [LPCM 16 bit 4CH]	(95)
[Proxy Rec Color Conversion]	[Conform to Custom Picture] , [BT.709 (Wide DR)], [BT.709 (CMT 709)]	(55)
[Chunk Rec: Time Setting]	[30 sec] , [1 min], [2 min]	(57)

Menu item	Setting options and additional information
[Metadata]	
[Camera Index]	[A] to [Z] (37)
[Reel Number], [Clip Number]	[001] to [999]
[User Defined]	User defined string up to 5 characters ([CANON]) (38)
[Stream Number/Proxy]	[01_Proxy], [01P] (38)
[Scene], [Take]	Scene description up to 16 characters / Take description up to 8 characters (108)
[Add XML File]	[On], [Off] (106, 107)
[XML File Format]	[News Metadata], [User Memo]
[News Metadata]	[Off], list of available News Metadata files
[News Metadata Reset All]	– (108)
[User Memo]	[Off], list of available user memo files (106)
[Country Code], [Organization], [User Code]	Identifiers up to 4 characters ([00_] default for [Organization] only) [Country Code]: This identifier is the country code defined by ISO-3166-1 and is to be entered starting from the left. [Organization]: This identifier represents the organization that owns or operates the camera and can be obtained by registering with the SMPTE Registration Authority. If the organization is not registered, enter [0000]. [User Code]: This identifier designates the user. Leave this blank if [Organization] is set to [0000].
[Add  File]	[On], [Off] (127)
[Clip Numbering]	[Reset], [Continuous] (37)
[Rec Command(EXT REC)]	[On], [Off] (151)
[HDMI Time Code]	[On], [Off] (151)
[MP4 Clip/Photo Numbering]	[Reset], [Continuous] (38)
[Volume Label]	[Canon], [Canon + Metadata] (33)
[OSD Recording]	[Time Code/Date/Time], [Date/Time], [Time Code], [Time], [Date], [Off] (43) Selects the onscreen displays that will be recorded as they appear on the screen. • Cannot be set while the CAMERA mode screen is rotated.
[OSD Recording Position]	[Top Left], [Top Right], [Bottom Left], [Bottom Right] (43) Selects the position of the onscreen displays that will be recorded as they appear on the screen. • Cannot be set while the CAMERA mode screen is rotated.

¹ The default value depends on the country/region of purchase.

[Audio Setup] menu

Menu item	Setting options and additional information
[Audio Input Selection]	
[CH1/CH2], [CH3/CH4]	[INPUT Terminals], [MIC Terminal], [Built-in Mic] (97) For [CH3/CH4] when a compatible optional accessory is attached to the multi-function shoe: [Input Terminals (Camera)], [MIC Terminal], [Built-in Mic], [Multi-Function Shoe]
[CH2 Input]	[INPUT 2], [INPUT 1], [Built-in Mic] ¹ , [MIC Terminal] ² (97) ¹ Only when recording with 4 channels and [Audio Input Selection] > [CH3/CH4] is set to [Built-in Mic], or when recording with 2 channels. ² Only when recording with 4 channels and [Audio Input Selection] > [CH3/CH4] is set to [MIC Terminal], or when recording with 2 channels.
[CH1/CH2 ALC Link], [CH3/CH4 ALC Link]	[Linked], [Separated] (99)

Menu item	Setting options and additional information	
[Audio Rec Level CH2], [Audio Rec Level CH3], [Audio Rec Level CH4], [Audio Rec Level CH3/CH4]	[Automatic] , [Manual]	(99)
[CH2 Level], [CH3 Level], [CH4 Level], [CH3/CH4 Level]	0 to 100 (50)	
[INPUT 1 Mic Trimming], [INPUT 2 Mic Trimming]	[+12 dB], [+6 dB], [0 dB] , [-6 dB], [-12 dB]	(100)
[INPUT 1 Mic Att.], [INPUT 2 Mic Att.]	[On], [Off]	(100)
[INPUT 1 Mic Low Cut], [INPUT 2 Mic Low Cut]	[Off] , [LC1], [LC2]	(101)
[INPUT Reference Level]	[-18 dB] , [-20 dB]	(100)
[INPUT Limiter]	[On], [Off]	(99)
[MIC Att.]	[On], [Off]	(100)
[MIC Low Cut]	[Off] , [LC1], [LC2]	(101)
[MIC Input]	[MIC (with Power Supply)] , [MIC], [LINE]	(97)
[Built-in Mic Sensitivity]	[Normal] , [High]	(100)
[Built-in Mic Att.]	[On], [Off]	(100)
[Built-in Mic Low Cut]	[Off] , [LC1], [LC2]	(101)
[1 kHz Tone]	[-12 dB], [-18 dB], [-20 dB], [Off]	(102)
[Headphone Volume]	[Off], 1 to 15 (8)	(140)
[Speaker Volume]	[Off], 1 to 15 (8)	
	In MEDIA mode only, this setting is an alternative way to adjust the built-in speaker's volume.	
[Monitor Channels]	[CH1/CH2] , [CH1/CH1], [CH2/CH2], [CH1+2/CH1+2], [CH3/CH4], [CH3/CH3], [CH4/CH4], [CH3+4/CH3+4], [CH1/CH3], [CH2/CH4], [CH1+3/CH2+4]	(159)
[HDMI OUT Channels]	[CH1/CH2] , [CH3/CH4]	
[Assign CH2 Switch & Dial]	[CH2] , [CH3]	(94)
	Adjust the audio levels for channel CH2 or CH3 using the CH2 audio level switch and dial.	

[ Monitoring Setup] menu

Menu item	Setting options and additional information	
[LCD Brightness], [LCD Contrast]	-50 to +50 (±0)	(23)
[LCD Color]	-20 to +20 (±0)	
[LCD Sharpness]	1 to 4 (2)	
[LCD Luminance]	[Normal] , [+1], [+2]	
[LCD Mirror Image]	[On], [Off]	
[VF Brightness], [VF Contrast]	-50 to +50 (±0)	(29)
[VF Color]	-20 to +20 (±0)	
[VF Sharpness]	1 to 4 (2)	
[VF Luminance]	[Normal] , [High]	
[VF Eye Sensor]	[On] , [Off]	(29)
[Run VF at x2 speed]	[On], [Off]	(29)

Menu item	Setting options and additional information	
[B&W Image: LCD], [B&W Image: VF], [B&W Image: SDI], [B&W Image: HDMI]	[On], [Off]	(23, 29)
[OSD Output: SDI], [OSD Output: HDMI]	[On], [Off]	(151)
[OSD Orientation: LCD/VF]	[0 Degrees], [↶ 90 Degrees Left], [↷ 90 Degrees Right]	(48)
[OSD Orientation: SDI], [OSD Orientation: HDMI]	[Linked to LCD/VF], [↶ 90 Degrees Left], [↷ 90 Degrees Right]	
[DISP Level 1]	[All Displays], [All Displays (Periph. Border)]	(46)
[DISP Level 2]	[Main Recording Displays], [Only FUNC/MENU]	
[DISP Level 3]	[Only REC/STBY], [No Displays]	
[Apply Peripheral Border]	[DISP Level 1/2/3], [DISP Level 1/2], [DISP Level 1], [DISP Level 2], [DISP Level 3], [Off]	(47)
[Custom Display 1]		(43)
[Light Metering], [Custom Picture]	[On], [Off]	
[Zoom Indicator]	[Bar], [Numerical]	
[Zoom Position], [Grip Zoom Speed: User], [Object Distance]	[Always On], [Normal], [Off]	
[ND Filter]	[Only Warnings], [Normal], [Off]	
[Focus Mode], [Key Lock], [Full Auto], [IR Rec], [White Balance], [AE Shift]	[On], [Off]	
[Exposure Bar]	[On], [Disable During AE], [Off]	
[Iris], [ISO/Gain], [Shutter], [Peaking], [Tele-converter], [Conversion Lens], [Magnification], [LUT], [Image Stabilizer]	[On], [Off]	

Menu item	Setting options and additional information	
[Custom Display 2]		(43)
[Remaining Battery], [Remaining Rec Time]	[Only Warnings], [Normal] , [Off]	
[Recording Mode], [Interval Counter], [Genlock], [Time Code], [Reel/Clip Number]	[On] , [Off]	
[Photo]	[Only Warnings], [Normal] , [Off]	
[Temperature/Fan], [Resolution/Color Sampling], [Frame Rate], [Output Terminals Status], [OSD Output]*, [Rec Command(EXT REC)], [User Memo]*, [User Bit]*, [OSD Recording], [Monitor Channels]*, [Audio Level Indicator], [Multi-Function Shoe], [Network Functions], [USB HOST], [GPS]	[On] , [Off] [On], [Normal]: Show the icon/onscreen display always or whenever the necessary conditions are triggered. [Only Warnings]: Show the icon/onscreen display only when a critical level is reached. • The default setting for items marked with an asterisk (*) is [Off].	
[Date/Time]	[Date/Time], [Time], [Date], [Off]	
[Custom Display]		(138)
	These settings are available only in MEDIA mode and determine whether the following onscreen displays will appear on the playback image.	
[Audio Level Indicator]	[On] , [Off]	
[Date/Time], [Camera Data]	[On], [Off] [Audio Level Indicator]: The audio level meter (clips only). [Date/Time]: The date and time when the clip/photo was recorded. [Camera Data]: The aperture value, shutter speed and ISO speed/gain value used to record the clip (clips only).	
[Displayed Units]	[Meters] , [Feet] ¹ Changes the distance units used in camera displays between meters and feet.	
[OSD Opacity: LCD], [OSD Opacity: VF], [OSD Opacity: SDI], [OSD Opacity: HDMI]	[On], [Off]	(152)
[OSD Opacity Level]	[75%] , [62.5%], [50%], [37.5%], [25%]	
[OSD Opacity: Appl. Screens]	[All] , [Only Rec/Playback Screens]	
[Tally OSD: LCD], [Tally OSD: VF], [Tally OSD: SDI], [Tally OSD: HDMI]	[On] , [Off]	(47)
[Tally OSD Settings]	[REC/Tally In (PGM/PVW)], [REC], [Tally In (PGM/PVW)]	
[Tally OSD Position]	[Frame] , [Top], [Bottom]	
[LUT: SDI]	[On], [Off]	(154)
[LUT Selection: SDI]	[BT.709] , [BT.2020], [DCI], [PQ], [HLG], [CMT 709], [User LUT1]* to [User LUT4]* * Available only when user LUTs have been registered in the camera.	
[View Assist: LCD], [View Assist: VF]	[On], [Off]	(154)
[Select View Assist: LCD], [Select View Assist: VF]	[BT.709] , [HDR Assist. (800%)], [HDR Assist. (400%)], [CMT 709]	(154)

Menu item	Setting options and additional information	
[View Assist: HDMI]	[On], [Off]	(📖 154)
[Select View Assist: HDMI]	[BT.709] , [CMT 709]	(📖 158)
[HLG Color]	[BT.2100], [Vivid]	(📖 156)
[Gain for HDR→SDR Conv.]	-7.5 dB to +7.5 dB in 0.5 dB intervals (-3.0 dB)	(📖 158)
[User LUT 1] to [User LUT 4]		(📖 154)
[Register]	List of available files.	
[Color Space (Output)]	[BT.709 Gamut], [BT.2020 Gamut], [Do Not Convert]	
[Range (Output)]	[Full Range], [Narrow Range]	
[Delete], [Rename]*	- * Up to 8 characters.	
[Reset All User LUTs]	-	
[User LUT Info]	-	
[Range: SDI]		(📖 152)
[During Canon Log Output]	[Full Range] , [Narrow Range]	
[During HDR Output]	[Full Range], [Narrow Range]	
[Range: HDMI]		(📖 152)
[During Canon Log Output]	[Full Range Priority] , [Narrow Range]	
[During HDR Output]	[Full Range Priority], [Narrow Range]	

¹ The default value depends on the country/region of purchase.

[🔍 Assistance Functions] menu

Menu item	Setting options and additional information	
[Focus Guide]	[On], [Off]	(📖 77)
[Peaking: LCD], [Peaking: VF], [Peaking: SDI], [Peaking: HDMI]	[On], [Off]	(📖 78)
[Peaking]	[Peaking 1] , [Peaking 2]	
[Peaking 1]		
[Color]	[White] , [Red], [Yellow], [Blue]	
[Gain]	[Off], 1 to 15 (8)	
[Frequency]	1 to 4 (2)	
[Peaking 2]		
[Color]	[White], [Red] , [Yellow], [Blue]	
[Gain]	[Off], 1 to 15 (15)	
[Frequency]	1 to 4 (1)	
[Magnification]	[On], [Off]	(📖 78)
[Magn. Output]	[LCD] , [VF], [SDI], [HDMI]	
[B&W during Magn.]	[On], [Off]	
[False Color: LCD], [False Color: VF], [False Color: SDI], [False Color: HDMI]	[On], [Off]	(📖 87)
[False Color Index]	-	

Menu item	Setting options and additional information	
[Zebra: LCD], [Zebra: VF], [Zebra: SDI], [Zebra: HDMI]	[On], [Off]	(87)
[Zebra]	[Zebra 1] , [Zebra 2], [Zebra 1+2]	
[Zebra 1 Level]	[5 ±5%] to [95 ±5%] in 5 percentage point intervals ([70 ±5%])	
[Zebra 2 Level]	0% to 100% in 5 percentage point intervals ([100%])	
[WFM: LCD], [WFM: VF], [WFM: SDI], [WFM: HDMI]	[On], [Off]	(103)
[WFM Opacity Level]	[Linked to OSD Opacity] , [100%], [80%], [60%], [40%], [20%] Select the WFM opacity level. If set to [Linked to OSD Opacity], it will be linked to the [OSD Opacity Level] setting.	
[WFM Function]	[Waveform Monitor] , [Vectorscope]	
[Waveform Settings]		(103)
[Size: LCD/VF]	[Normal] , [2x] Changes the size of the waveform displayed on the screen.	
[Position]	[Right] , [Left]	
[Type]	[Line] , [Line+Spot], [Select Line], [RGB], [YPbPr]	
[Gain]	[1x] , [2x]	
[Vertical Scale for HDR]	[IRE] , [PQ/HLG]	
[Y Position]	[0%] , [15%], [30%], [45%], [50%]	
[Select Line]	0 to 719 in 1-line increments ([360]), 0 to 1079 in 1-line increments ([540]), 0 to 2158 in 2-line increments ([1080]) Available options depend on the resolution and operating mode (CAMERA/MEDIA mode).	
[Vectorscope Settings]		(104)
[Position]	[Right] , [Left]	
[Type]	[Normal] , [Spot]	
[Gain]	[1x] , [2x]	
[Markers: LCD], [Markers: VF], [Markers: SDI], [Markers: HDMI]	[On] , [Off]	(85)
[Center Marker]	[Yellow], [Blue], [Green], [Red], [Black], [Gray], [White], [Off]	(85)
[Center Marker Type]	[Cross 1] , [Cross 2], [Dot 1], [Dot 2]	
[Horizontal Marker], [Vertical Marker], [Grid Marker]	[Yellow], [Blue], [Green], [Red], [Black], [Gray], [White], [Off]	
[Aspect Marker]	[Yellow], [Blue], [Green], [Red], [Black], [Gray], [White], [Mask 100%], [Mask 75%], [Mask 50%], [Mask 25%], [Off]	(86)
[Marker Aspect Ratio]	[4:3], [13:9], [14:9], [16:9], [1.375:1], [1.66:1], [1.75:1], [1.85:1], [1.90:1], [2.35:1], [2.39:1] , [9:16], [Custom]	
[Marker Custom Asp. Ratio]	1.00:1 to 9.99:1 ([1.00:1])	
[Safe Area Marker]	[Yellow], [Blue], [Green], [Red], [Black], [Gray], [White], [Mask 100%], [Mask 75%], [Mask 50%], [Mask 25%], [Off]	(86)
[Basis for Marker Safe Area]	[Whole Picture] , [Selected Aspect Marker]	
[Marker Safe Area %]	[80% (Side Length)], [88% (Side Length)], [90% (Side Length)], [93% (Side Length)], [95% (Side Length)] , [80% (Area)], [90% (Area)], [92.5% (Area)], [95% (Area)]	
[User Marker 1], [User Marker 2]	[Yellow], [Blue], [Green], [Red], [Black], [Gray], [White], [Off]	(86)
[User Marker 1 Size], [User Marker 2 Size]	2x2 to 1920x1080 only even numbers ([100x100])	
[User Marker 1 Position], [User Marker 2 Position]	(-960, -540) to (960, 540) ([0, 0])	

[🌐 Network Settings] menu

Menu item	Setting options and additional information
[Network]	[Enable], [Disable] (📖 166)
[Connect]	[Disconnect] , [SET1] to [SET20]
[Connection Setting]	[SET1] to [SET20] (📖 175)
[Check Settings]	–
[Change with Wizard]	–
[Select Existing Setting]	–
[Settings Name]	File name up to 12 characters
[Delete Settings]	–
[New Conn. Setting (Wizard)]	[FTP Transfer], [IP Streaming], [Browser Remote], [Canon App], [XC Protocol] (📖 167)
[Activate IP Streaming]	[Enable], [Disable] (📖 182)
[FTP Transfer All Clips]	In MEDIA mode only. (📖 181)
[IPv4 address name]	Displays the current IPv4 address information.
[View Error Info]	Displays the latest network related error message.
[Advanced Settings]	(📖 176)
[Communication Settings]	[NW1] to [NW25]
[Function Settings]	[MODE1] to [MODE25]
[Browser Remote Settings]	[User Name/Password], [Port No. (HTTP)], [Port No. (HTTPS)], [HTTPS] (📖 178)
[XC Protocol Settings]	[Authentication Method], [User Name/Password], [Port No. (HTTP)] (📖 171)
[802.1X Authentication]	[Setup Wizard], [Check Settings], [Delete Settings] (📖 175)
[Nickname]	User defined string up to 16 characters ([XF605]) (📖 175)

[🔗 Assignable Buttons] menu

Following are the default settings for each assignable button. For a complete list of the functions that can be assigned, refer to the detailed table (📖 120).

Menu item	Setting options and additional information
[Camera]	1: [Powered IS] , 2: [Peaking: LCD/VF] , 3: [Zebra: LCD/VF] , 4: [WFM: All] , 5: [Review Recording] , 6: [Magnification] , 7: [Magnification] (MEDIA mode: [INDEX]), 8: [FUNC] , 9: [Status] , 10: [DISP] , 11: [(NONE)]
[Browser Remote/XC Prot.]	(📖 119)
[Link to Camera]	[Enable], [Disable]
	1: [Magnification] , 2: [Peaking: All] , 3: [Zebra: All] , 4: [WFM: All]
[REMOTE A/B]	(📖 119)
[Link to Camera]	[Enable], [Disable]
	1: [Magnification] , 2: [Peaking: All] , 3: [Zebra: All] , 4: [WFM: All]

[🔧 System Setup] menu

Menu item	Setting options and additional information
[Reset]	[All Settings], [Assignable Buttons] These settings reset the following camera settings to default values/settings. [All Settings]: All the camera's settings except for the hour meter. [Assignable Buttons]: Only the assignable buttons.

Menu item	Setting options and additional information	
[Transfer Menu/ CP]		(133)
[Save]	[To Camera], [To SD Card B]	
[Load]	[From Camera], [From SD Card B]	
[Time Zone]	List of world time zones. [UTC-05:00 New York] or [UTC+01:00 Central Europe] ¹	(24)
[Date/Time]	–	
[Date Format]	[YMD], [YMD/24H], [MDY] , [MDY/24H], [DMY] , [DMY/24H] ¹	
[Language 	[Deutsch], [English] , [Español], [Français], [Italiano], [Polski], [Português], [Русский], [Українська], [简体中文], [한국어], [日本語]	(24)
[REMOTE Term.]	[NU Protocol (REMOTE B)], [Standard + RC-V100], [RC-V100 (REMOTE B)], [RC-V100 (REMOTE A)], [Standard]	(115)
	NU Protocol refers to a Canon proprietary communication protocol that makes connecting to certain accessories possible.	
[HDMI Output Signal]	[3840x2160P] , [1920x1080P], [1920x1080i], [1280x720P]	(151)
[Linked to HDMI Monitor]	[On] , [Off]	
[SDI Output]	[On] , [Off]	(150)
[SDI Output Signal]	[3840x2160P], [1920x1080P] , [1920x1080i(PsF)], [1280x720P], [720x480i]* or [720x576i]* * Depends on the system frequency.	
[3G-SDI Mapping]	[Level A], [Level B]	(150)
[SD Resize on Output]	[Letterbox], [Side Crop], [Squeeze]	(150)
[Time Code Mode]	[Preset] , [Regen.]	(88)
[Time Code Run]	[Rec Run] , [Free Run]	
[Time Code DF/NDF]	[DF] , [NDF]	(89)
[Set Time Code]	[00:00:00:00] to 59.94 Hz: [23:59:59:29] 50.00 Hz: [23:59:59:24]	(88)
[TC In/Out]	[In] , [Out]	(91, 92)
[User Bit Recording Mode]	[Internal] , [External]	(91)
[User Bit Type]	[Setting] , [Time], [Date]	(90)
[G-LOCK/SYNC Term.] ²	[HD Sync Output], [Genlock Input]	(92, 93)
[Genlock Adjustment] ²	–1023 to +1023 (000)	(92)
	The phase difference between the external Genlock signal and the camera is initially set to 0. This setting allows you to adjust it within the range of approx. ±0.4 H (–1023 to 1023). To set a 4-digit adjustment value, set the first field to 10 or –10.	
[SYNC Scan Mode]	[P] , [PsF]	(93)
[Key Lock]	[All Buttons], [All Except REC Button]	(15)
[REC Button]	[Disable], [Enable]	
	Enables or disables the use of the REC buttons.	
[Assign. Button 11 as REC]	[On], [Off]	(119)
	When this setting is set to [On], assignable button Camera 11's function changes to [REC] and cannot be changed. This turns assignable button 11 to an alternative REC button.	
[Onscreen REC/STBY Button]	[On], [Off]	(42)
	When this setting is set to [On], the recording operation indicator (REC/STBY) on the CAMERA mode screen becomes an onscreen button you can touch to start/stop recording.	
[Touch Screen Response]	[Normal] , [Low]	(23)
[Power Supply LED]	[On] , [Off]	(14)
	When this setting is set to [Off], the power indicator will not illuminate even when the camera is powered on.	

Menu item	Setting options and additional information
[Tally Lamp (Front)], [Tally Lamp (Rear)]	[On], [Off] (14, 17) When this setting is set to [On], the tally lamp illuminates/flashes according to the camera and tally input status.
[Tally Lamp Settings]	[Power/Media/Tally In (PGM)], [REC/Tally In (PGM)], [REC], [Tally In (PGM)] When this setting is set to [Power/Media/Tally In (PGM)], the tally lamp illuminates/flashes according to battery and recording warnings and the SD card recording status.
[SD Card Access LED]	[On], [Off] (32) When this setting is set to [On], the card access indicator illuminates when the camera is accessing the card.
[Fan Mode]	[Automatic], [Always On] (40)
[Review Recording]	[Entire Clip], [Last 4 sec] (49)
[GPS Auto Time] ²	[On], [Off] When this setting is set to [On], the camera automatically adjust its date and time settings according to the information received from the GPS signal. <ul style="list-style-type: none"> • While the automatic date/time adjustment is activated, the MENU > [ System Setup] > [Date/Time] setting will not be available. • The time will not be updated while recording video.
[USB (Type-C) Mode]	[Video Output (UVC)], [Canon App(s) for iPhone], [PTP Connection/GP-E2] (117) Select [PTP Connection/GP-E2] when connecting the GP-E2 GPS Receiver to the camera using an optional interface cable.
[DC IN Warning (V)]	11.5 V to 15.0 V in 0.1 V intervals (13.0 V) (22)
[Reset Hour Meter]	The camera has two “hour meters” – the first keeps track of total operation time and the second keeps track of operation time since the last time the second hour meter was reset with this function.
[Certification Information]	This displays select certification information that apply to this camera.
[Firmware]	
[Camera]	Check/update the firmware version of the camera.

¹ The default value depends on the country/region of purchase.

² Only when the GP-E2 GPS Receiver is connected to the camera.

[My Menu] menu (CAMERA mode only)

Menu item	Setting options and additional information
[CAMERA-1: Edit] to [CAMERA-5: Edit]	[Register], [Move], [Delete], [Reset All], [Rename] (26)

Displaying the Status Screens

You can use the status screens to check the camera's various settings. You can also output the status screens to an external monitor.

1 Press the STATUS button to open the status screens.

- The status screen most recently displayed will appear unless you turned off the camera or changed the operating mode.
- You can also press the AUDIO STATUS button to open directly only the [🎵] Audio Setup] status screen.

2 Scroll through the status screens to check the desired settings.

- You can also touch the icons on the screen to display the desired screen.
- Bring the cursor to a page number and push the joystick left/right to move between the status screens.
- You can also touch the desired page number, or flick the screen to the left/right to move between pages.

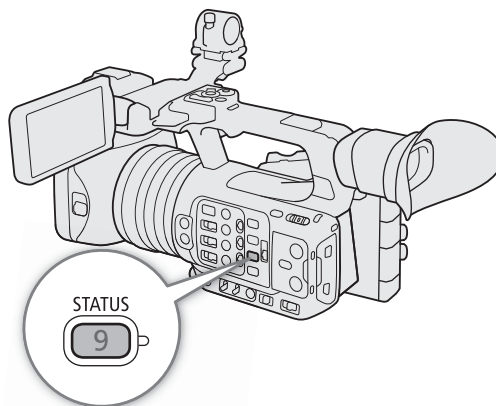

3 Press the STATUS button again or select [X CLOSE] to close the status screens.

- You can also touch [X] to close the status screens.
- You can also press the MENU button to close the status screens and open the menu instead.

To skip directly to the page of a specific status screen:

[☑] Gamma/Color Space/Range	(📖 209)	[🎵] Audio Setup]	(📖 212)
[📷] (custom picture file in use)	(📖 209)	[🔧] System Setup]	(📖 213)
[📺] Camera Setup]	(📖 210)	[📀] Recording/Media Setup]	(📖 214)
[⚙️] Assignable Buttons]	(📖 211)	[🌐] Network Settings]	(📖 215)

[**Γ**] Gamma/Color Space/Range] status screens (CAMERA mode only)

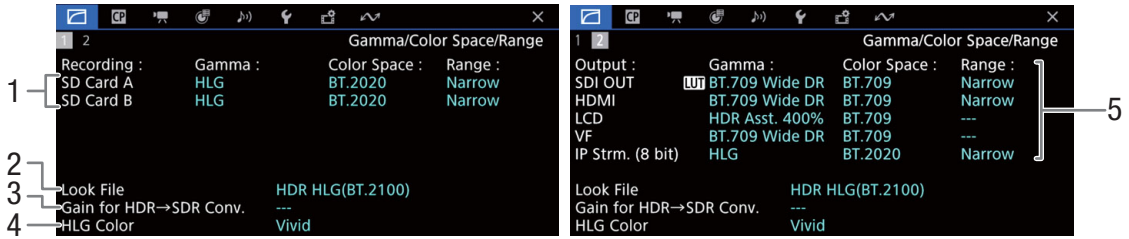

- 1 Gamma curve, color space (📖 128) and range used for clips recorded on the cards
- 2 Look File applied (📖 126)
- 3 Gain for HDR-to-SDR conversion (📖 158)
- 4 HLG color quality (📖 128)
- 5 Gamma curve, color space (📖 128, 154) and range (📖 152) used for video outputs/monitoring devices
 [SDI OUT]: Video output from the SDI OUT terminal.
 [HDMI]: Video output from the HDMI OUT terminal
 [LCD]: LCD screen
 [VF]: Image output from the viewfinder.
 [IP Strm. (8 bit)]: IP streaming signal (📖 182)

[**CP**] status screens (CAMERA mode only)

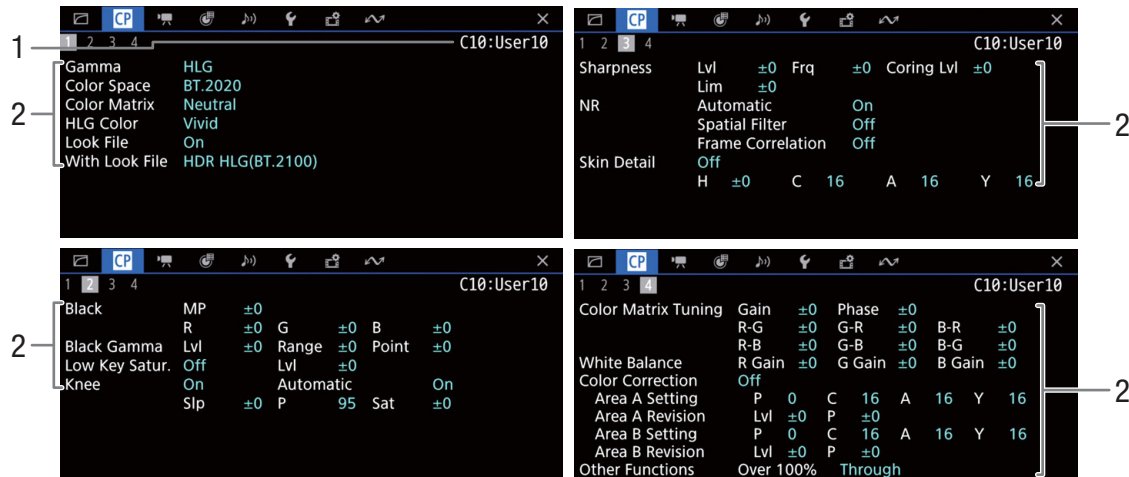

- 1 Custom picture file name (📖 124)
- 2 Custom picture settings (📖 128)

210

[Camera Setup] status screens (CAMERA mode only)

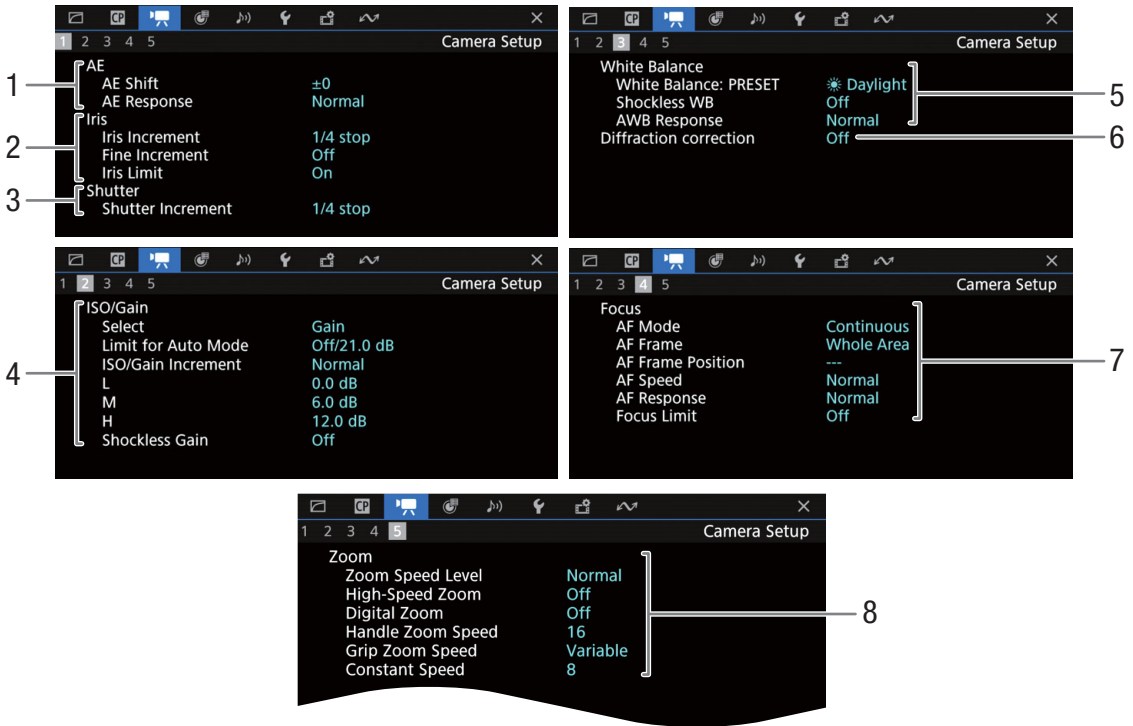

- | | |
|--|--|
| <ul style="list-style-type: none"> 1 Automatic exposure (AE)
AE shift (67), AE response (65) 2 Aperture (65)
Iris increment, fine increment, iris limit 3 Shutter speed increment (60) 4 ISO speed/Gain (62)
Selected mode, limit for automatic adjustment,
ISO/Gain increment, ISO/GAIN switch, shockless gain | <ul style="list-style-type: none"> 5 White balance (68)
PRESET, shockless white balance, auto white balance (AWB) response 6 Lens diffraction correction (29) 7 Focus (76)
AF mode, AF frame settings, AF speed and response settings, focus limit 8 Zoom (71)
Zoom speed level, high-speed zoom, digital zoom, handle zoom speed, grip zoom speed, constant speed |
|--|--|

[Assignable Buttons] status screens

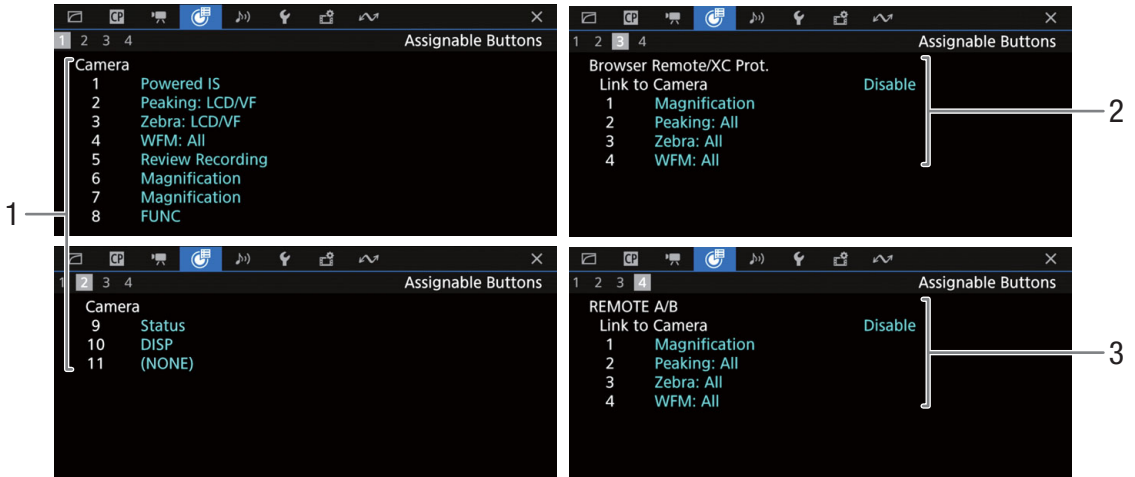

Current functions of the assignable buttons (📖 119)

- 1 On the camera's body
- 2 Browser Remote, XC Protocol
- 3 On the RC-V100 Remote Controller

[🎵] Audio Setup] status screens

CAMERA mode:

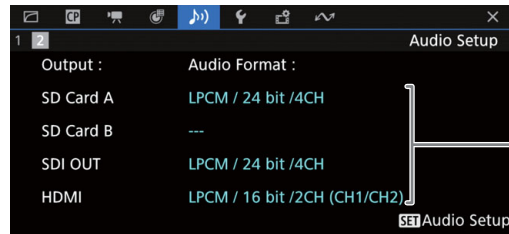

MEDIA mode:

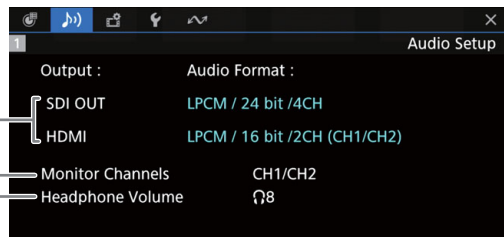

- 1 Audio source input, audio level adjustment mode and audio level indicator for each audio channel (📖 94)
- 2 Audio channels output from the headphones/speaker (📖 159)
- 3 Headphone volume (📖 140)
- 4 Audio configuration used for recording on the cards (📖 94) and for output (SDI OUT terminal, HDMI OUT terminal, 📖 159)
- 5 Press SET to open the [🎵] Audio Setup] menu (only when the status screen was opened using the AUDIO STATUS button)

[🔧 System Setup] status screens



- | | |
|---|---|
| <ul style="list-style-type: none"> 1 HDMI OUT terminal status (📖 151): Signal type (HDMI/DVI), video output, frame rate, audio output 2 Time code output from the HDMI OUT terminal¹ (📖 151) 3 Output of onscreen displays (📖 151) 4 SDI OUT terminal status (📖 150): Video output, 3G-SDI mapping 5 Output of onscreen displays (📖 151) 6 User bit¹ (📖 90) 7 USB (Type-C) mode status | <ul style="list-style-type: none"> Information about the Canon battery pack (📖 19) 8 Remaining recording time 9 Remaining charge level (visual bar) 10 Battery life indicator 11 Total operation time 12 Operation time since using [Reset Hour Meter] (📖 207) 13 GPS information²
Latitude, longitude, elevation, coordinated universal time (UTC) |
|---|---|

¹ CAMERA mode only.

² Only when the GP-E2 GPS Receiver is connected to the camera.

[Recording/Media Setup] status screens

Pages 2 to 7 are displayed only in CAMERA mode.

214

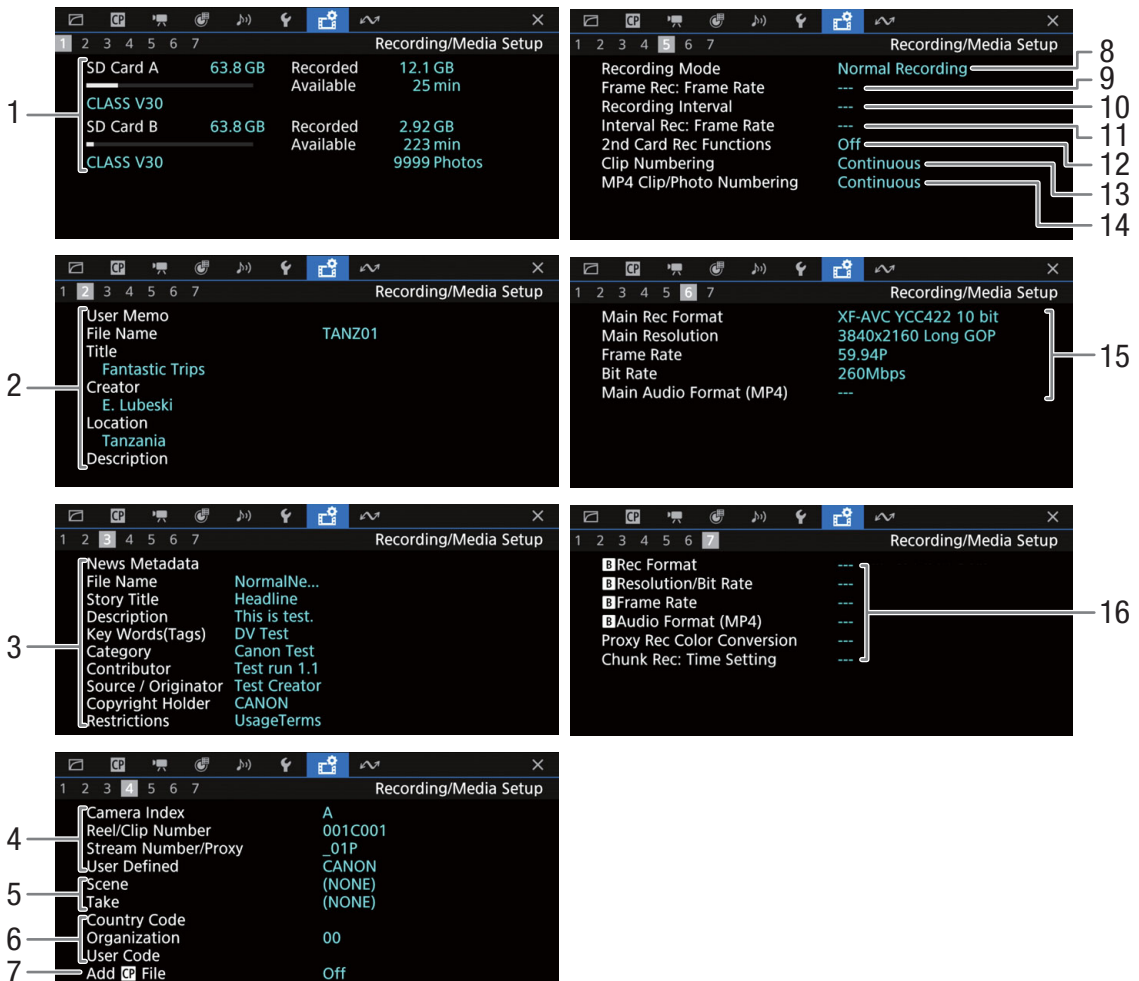

- 1 Information about SD cards A and B
Visual bar*, total capacity, used (recorded) space, approximate available recording time, speed class and number of remaining photos (SD card B only)
* Repeatedly recording short clips at low bit rates (such as for chunk recording) may result in not being able to record even if there is available card space.
- 2 User memo (106)
User memo file name, title, creator, location and description
- 3 News Metadata (106)
File Name, Story Title, Description, Keyword (Tags), Category, Contributor, Source/Originator, Copyright Holder, Restrictions.
- 4 Clip name information (37)
Camera index, reel/clip number, stream number/proxy, user-defined field
- 5 Scene and take information (108)
- 6 Unique material identifier (UMID) code (199): country, organization, user
- 7 Custom picture file embedded (127)
- 8 Recording mode (35)
- 9 Frame recording frame rate (111)
- 10 Interval recording time interval (112)
- 11 Interval recording frame rate (112)
- 12 Second card recording function (35)
- 13 Clip numbering (37)
- 14 MP4 clip/photo numbering (38)
- 15 Main recording video configuration (54)
Video format, color sampling, resolution, frame rate, bit rate and audio format (only MP4 clips) (95)
- 16 recording video configuration (58)
Video format, resolution and bit rate, frame rate, audio format (only MP4 clips) (95), color conversion for proxy clips, chunk recording time setting

i NOTES

- Depending on the card, the total space displayed on the screen may differ from the nominal capacity printed on the card itself.

[Network Settings] status screens

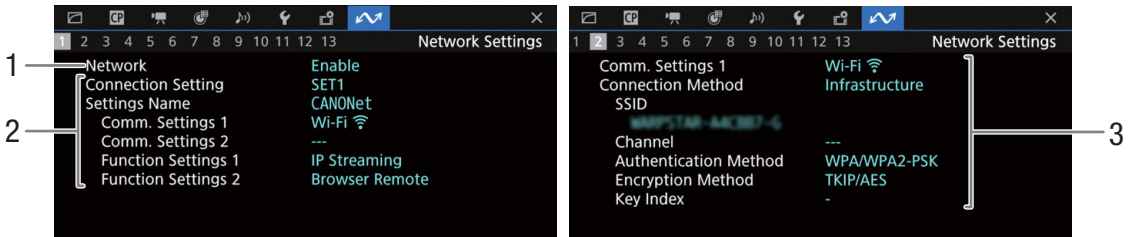

Network connection used (166)

- | | |
|---|---|
| <ol style="list-style-type: none"> 1 Network functions activated/deactivated 2 Connection setting in use 3 Connection setting (SET) number, name, communication settings (primary network and secondary network) and function settings | <ol style="list-style-type: none"> 3 Communication settings of the primary/secondary network
Network type, connection method, SSID (network name), Wi-Fi channel, authentication, encryption and key index |
|---|---|

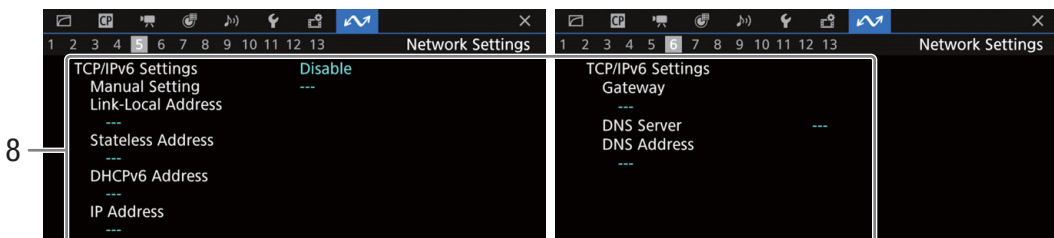
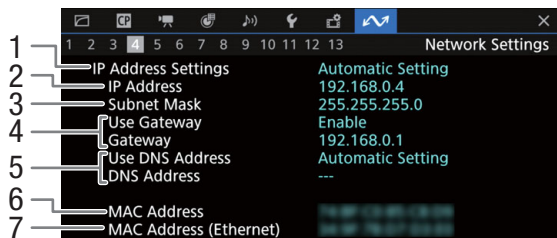

TCP/IP settings of the current network connection (174)

- | | |
|--|---|
| <ol style="list-style-type: none"> 1 IP address assignment method 2 IP address 3 Subnet mask 4 Default gateway | <ol style="list-style-type: none"> 5 DNS server 6 Camera's MAC address 7 MAC address (Ethernet) 8 IPv6 settings (177) |
|--|---|

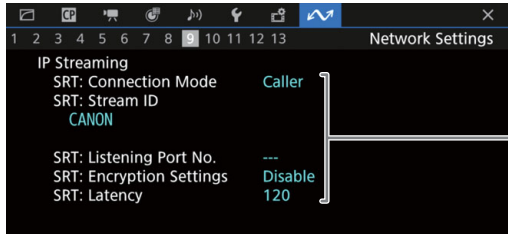
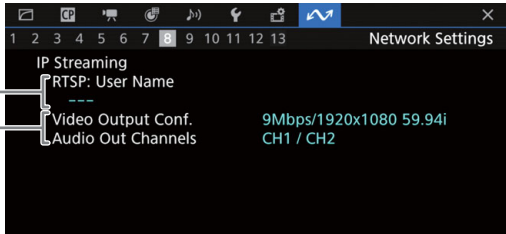
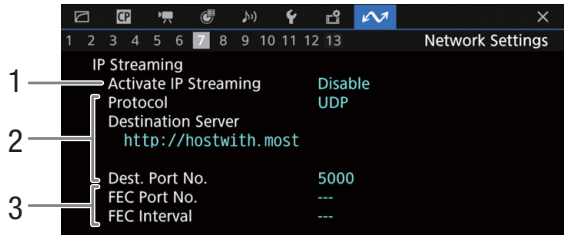

IP streaming settings (CAMERA mode only, 169)

- 1 IP streaming activated/deactivated (182)
- 2 Streaming protocol and receiver settings
- 3 Error correction settings
- 4 RTSP user name required to control streaming sessions
- 5 Streaming video configuration and audio channels
- 6 IP Streaming SRT settings: connection mode, stream ID, listening port number, encryption, latency

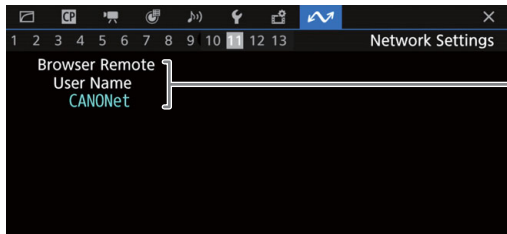
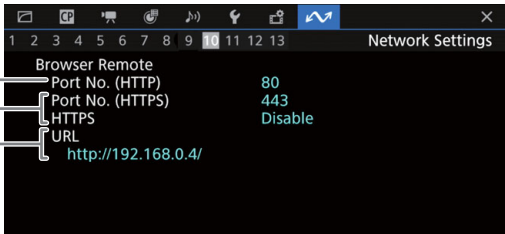

Settings for Browser Remote (CAMERA mode only, 170)

- 1 Port number (HTTP)
- 2 HTTPS connection (178) Port number, HTTPS activated/deactivated
- 3 Camera's URL
- 4 Users

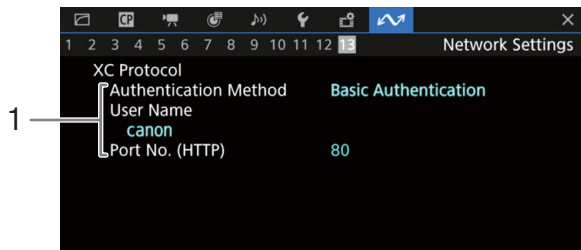

XC Protocol (CAMERA mode only, 191)

- 1 Authentication Method, User name, Port number (HTTP)



FTP transfer settings (MEDIA mode only, 167)

- 1 Transfer mode, user name and FTP server (or host) name



Canon App

- 1 Canon App
Connection device name, USB (Type-C) mode

Troubleshooting

If you have a problem with your camera, refer to this section. Consult your dealer or a Canon Service Center if the problem persists.

Power source

The camera will not turn on or it turns off by itself.

- The battery pack is depleted. Replace or charge the battery pack.
- Remove the battery pack and reattach it correctly.

Shortly after turning it on, the camera turns off on its own.

- You are using a battery pack that is not compatible for use with this camera. Use a recommended battery pack (☐ 233).

Cannot charge the battery pack.



- The temperature of the battery pack is outside the charging range. If the battery pack's temperature is below 0 °C (32 °F), warm it before charging it; if it is above 40 °C (104 °F), let the battery pack cool down before charging it.
- Charge the battery pack in temperatures between 0 °C and 40 °C (32 °F and 104 °F).
- The battery pack is faulty. Replace the battery pack.

The battery pack is depleted extremely quickly even at normal temperatures.

- Check the [🔧 System Setup] status screen (☐ 213) to check if the battery pack has reached the end of its battery life. If so, buy a new battery pack.

Recording

The camera's controls are not responsive/disabled.

- When the KEY LOCK switch is set to , all buttons excluding lens rings (or all buttons with the exception of REC buttons and the INFRARED switch) are locked and cannot be operated. Set the KEY LOCK switch to . You can change which controls are locked with the **MENU** > [🔧 System Setup] > [Key Lock] setting.

Performing a recording operation (pressing a button/touching the onscreen button) will not start recording.

- The card is full or it already contains the maximum number of clips (999 clips). Delete some clips (☐ 144) or save your recordings and initialize the card (☐ 32) to free some space. Alternatively, replace the card.
- The REC button was pressed while all the camera's controls were locked (key lock, ☐ 15). Unlock the controls or set **MENU** > [🔧 System Setup] > [Key Lock] to [All Except REC Button].
- The REC button that was used may be disabled. Change the **MENU** > [🔧 System Setup] > [REC Button] and [Onscreen REC/STBY Button] settings to enable the use of the desired button or onscreen button.
- Power supply to the camera has reached the level set for the power level warning (☐ 207). Check the power source.
- The camera cannot record while the [Color Correction] settings in the custom picture file (☐ 131) are being adjusted (except for the [Revision Level]/[Revision Phase] settings).

The point when the recording operation was performed does not match the beginning/end of the recording.

- There may be a slight interval between pressing the REC button (or touching the onscreen button) and the actual start/end of recording. This is not a malfunction.

The camera will not focus.

- The camera may not be able to focus on certain subjects using autofocus. Focus manually (☐ 76).
- When the AF mode is set to AF-boosted MF, start focusing manually until the AF frame changes to white (automatic adjustment range).
- The viewfinder is not adjusted. Use the diopter adjustment lever to make the proper adjustment (☐ 29).
- The lens is dirty. Clean the lens with a soft lens-cleaning cloth.

When a subject flits across in front of the lens, the image appears slightly bent.

- This is a phenomenon typical of CMOS image sensors. When a subject crosses very quickly in front of the camera, the image may seem slightly warped. This is not a malfunction.

Bright red, green or blue dots appear on the screen.

- The camera's CMOS sensor is a delicate piece of precision engineering. Direct exposure of the sensor to ion rays or other types of cosmic radiation may affect it and this may rarely appear as bright colored dots on the screen. This is the nature of CMOS image sensors and does not represent a malfunction.
- The effects of the damage may be more noticeable when the camera is used in places subject to high temperatures, when a high ISO speed or gain level is used and when slow shutter speeds are used.

Abnormal images appear on the screen and the camera cannot record properly.

- While recording using an almost empty battery pack together with an AC adapter, the AC adapter was inadvertently disconnected or the power supply was suddenly interrupted. Reconnect the AC adapter and turn the camera off and then on again or replace the battery pack with a fully charged one.

Changing between recording (●REC) and record standby (STBY) takes longer than usual.

- When the card contains a large number of clips, some operations may take longer than usual. Save your recordings and initialize the card (☐ 32). Alternatively, replace the card.

Clips or photos cannot be recorded properly.

- This may occur as clips and photos are recorded/deleted over time. Save your recordings and initialize the card (☐ 32).

After using the camera for a long time, it becomes hot.

- The camera may become hot after using it continuously for long periods of time; this is not a malfunction. If the camera becomes unusually hot or it becomes hot after using it only for a short while, it may indicate a problem with the camera. Consult a Canon Service Center.

Playback

Cannot delete clips/photos

- XF-AVC clips with an **OK** mark cannot be deleted with the camera. Remove the **OK** mark (☐ 143).
- The LOCK switch on the SD card is set to prevent accidental erasure. Change the position of the LOCK switch.
- Photos that were protected using other devices cannot be deleted with this camera.

Deleting clips takes longer than usual.

- When the card contains a large number of clips, some operations may take longer than usual. Save your recordings and initialize the card (☐ 32).

Indicators and Onscreen Displays

 appears in red on the screen.

- Battery pack is depleted. Replace or charge the battery pack.

 appears on the screen.

- The camera cannot communicate with the battery pack attached so the remaining battery time cannot be displayed.

The power indicator/tally lamp does not illuminate.

- Set **MENU** > [ System Setup] > [Power Supply LED], [Tally Lamp (Front)] or [Tally Lamp (Rear)] to [On].

 appears in red on the screen.

- Overcurrent has been detected in the device connected to the USB (HOST) terminal. Disconnect the device and turn on the camera again.

The power indicator/tally lamp flashes quickly.  (4 flashes per second)

- The battery pack is depleted. Replace or charge the battery pack.
- There is not enough available space on the cards. Delete recordings (☐ 144) to free some space or replace the card.
- A system error has occurred. Turn the camera off and then on again. If this does not solve the problem, consult a Canon Service Center.

The power indicator/tally lamp flashes slowly.  (1 flash per second)

- The combined available space on the cards is low. Delete recordings (☐ 144) to free some space or replace the card.

 appears in red on the screen.

- An SD card error occurred. Remove and reinsert the SD card. If the display does not change back to normal, save your recordings and initialize the SD card (☐ 32).

A / B appears in red on the screen followed by [END].

- The indicated card is full. Delete recordings (📖 144) to free some space or replace the card.

Even after stopping recording, the access indicator stays illuminated in red.

- The clip is being recorded on the card. This is not a malfunction.

🔥 appears in yellow on the screen.

- The camera's internal temperature has reached a predetermined level. You can continue using the camera.

🔥 appears in red on the screen.

- The camera's internal temperature has reached a higher level. Turn off the camera and wait until the temperature has decreased.

FAN appears in red on the screen.

- The cooling fan may not be working properly. The camera will automatically turn off after a few minutes. Consult a Canon Service Center.

The ND filter indicator appears in red or as [- -] on the screen, and the ND filter indicators on the RC-V100 Remote Controller are flashing.

- The ND filter mechanism may not be working properly. Consult a Canon Service Center.

Picture and Sound

There is no picture from an external monitor.

- Make sure the cable connecting the camera to the monitor is correctly connected on both sides.
- Check that the correct video input is selected on the external monitor.

There is no picture or sound from an external monitor connected to the SDI OUT terminal

- **MENU** > [🔧 System Setup] > [SDI Output] is set to [Off].
- Check that the settings of the external monitor/recorder match the configuration of the output signal selected on the camera (📖 145).
- Check that the external monitor's settings match the configuration of the output signal selected on the camera (📖 145).
- Replace the cable.

There is no picture or sound from an external monitor/recorder connected to the HDMI OUT terminal

- Disconnect the HDMI cable and then restore the connection or turn the camera off and then on again.
- Check that the settings of the external monitor/recorder match the configuration of the output signal selected on the camera (📖 145).
- Replace the HDMI cable.

An assistance display (peaking/zebra pattern/video scope/onscreen markers/false color/magnification/B&W image/LUT/view assistance/tally OSD) does not appear or is not applied on the screen.

- These assistance displays have separate settings that allow you to turn the display on/off on individual monitoring devices/video outputs. Check the settings to see that the desired function is enabled on the desired monitor/video output.
- Onscreen displays output has not been enabled. Activate the output of the camera's onscreen displays (📖 151).

Screen displays turn on and off repeatedly.

- The battery pack is depleted. Replace or charge the battery pack.
- Remove the battery pack and reattach it correctly.

Abnormal characters appear on the screen and the camera does not operate properly.

- Remove all the cards and disconnect the power source. After a moment, reconnect the power and reinsert the cards. If the problem still persists, use the **MENU** > [🔧 System Setup] > [Reset] > [All Settings] function. This resets all the camera's settings to default values, except for the hour meter.

Video noise appears on screen.

- Keep a distance between the camera and devices that emit strong electromagnetic fields such as near powerful magnets and motors, MRI machines or high-voltage power lines.

Horizontal bands appear on the screen.

- This is a phenomenon typical of CMOS image sensors when recording under some types of lighting. This is not a malfunction. You may be able to reduce the symptoms by setting the shutter speed mode to [Speed] and the shutter speed to a value matching the frequency of the local electrical system: 1/50* or 1/100 for 50 Hz systems, 1/60 or 1/120 for 60 Hz systems.

*May not be available depending on the frame rate.

Audio is not recorded.

- The audio input source is not correctly selected (☐ 97) or a microphone is not connected to the selected terminal.
- When using the INPUT 1/INPUT 2 terminals, make sure you are using an XLR connector. When using the MIC terminal, make sure you are using a condenser microphone with a Ø 3.5 mm stereo mini plug.
- The external microphone is not turned on or its battery is depleted.
- The external microphone connected to the INPUT 1/INPUT 2 terminal requires phantom power. Set the corresponding INPUT 1/INPUT 2 audio source selection switch to MIC+48V (☐ 97).
- The external microphone connected to the MIC terminal requires plug-in power but **MENU** > [🎧] Audio Setup] > [MIC Input] is set to an option other than [MIC (with Power Supply)].
- To record audio for slow & fast motion clips, set the recording mode to [S&F Clip / Audio (WAV)] (☐ 35).

Sound is distorted or is recorded at lower levels.

- This may happen when the appropriate audio level is not set correctly. Adjust the audio recording level manually (☐ 99). You can also activate the microphone attenuator (☐ 100) to reduce the audio level.
- The audio source selected for the INPUT terminal or MIC terminal is incorrect. When using an external microphone, set the INPUT switch to MIC or set **MENU** > [🎧] Audio Setup] > [MIC Input] to one of the [MIC] options. When using an analog audio device set the INPUT switch or the [MIC Input] setting to [LINE].
- The audio level is adjusted manually and the recording level is set too low. Check the audio level meter on the screen and adjust the audio level correctly (☐ 98).

The picture is displayed correctly but there is no sound from the built-in speaker.

- Speaker volume is turned off. Adjust the volume (☐ 140).
- Disconnect any cables/external devices connected to the 🎧 (headphone) terminal.

Cards and Accessories

Cannot insert the card.

- The card you are trying to insert is not facing the correct direction. Turn it over and insert it (☐ 32).

Cannot record on the SD card.

- A compatible card must be used (☐ 31).
- Initialize the card (☐ 32) when you use it with the camera for the first time.
- The card is full or it already contains the maximum number of clips (999 clips). Delete recordings (☐ 144) to free some space or replace the card.
- The clip number has reached its maximum value. Save your recordings and initialize the card (☐ 32) or delete all the clips (☐ 144).
- The LOCK switch on the SD card is set to prevent accidental erasure. Change the position of the LOCK switch.
- The folder and file numbers for MP4 clips and photos have reached their maximum value. Set **MENU** > [📷 Recording/Media Setup] > [MP4 Clip/Photo Numbering] to [Reset] and insert a new card.

Recording to and playing back from a card is slow.

- This may occur as recordings are made and deleted repeatedly over time. Save your recordings and initialize the card (☐ 32).

The RC-V100 Remote Controller or commercially available remote control does not work.

- Make sure that **MENU** > [🔧 System Setup] > [REMOTE Term.] is set to [RC-V100 (REMOTE B)] or [RC-V100 (REMOTE A)] when using the RC-V100 Remote Controller or to [Standard] when using a commercially available remote control (☐ 115).
- Turn off the camera, reconnect the remote controller and then turn the camera back on again.
- When the currently selected custom picture file is protected, detailed custom picture settings cannot be adjusted using the RC-V100. Unprotect the file (☐ 125).

Connections with External Devices

Video noise appears on a nearby TV screen.

- When using the camera in a room where a TV is located, keep a distance between the AC adapter and the power or antenna cables of the TV.

Network Functions

Check This First

- Are the camera, computer or other network devices all turned on?
- Is the network working and correctly configured?
- Are all network devices correctly connected to the same network as the camera?
- When using a Wi-Fi network, are there any obstructions between the camera and the access point or between the network device used and the access point?

Cannot connect with an access point.

Cannot establish a Camera Access Point connection with a network device.

- If the network connection icon (☐ 180) does not turn white, turn the camera off and then on.
- When connecting to an access point, check that the settings on the network device the camera is trying to connect with are correct.
- When you reset all the camera settings, all network settings are lost as well. Configure the network settings again (☐ 171).
- The wireless signal is not strong enough or there are other devices in the vicinity interfering with the wireless signal. Refer to *Precautions Regarding Wi-Fi Networks* (☐ 223).

Cannot connect with a wired (Ethernet) network.

- Use a category 5e or better shielded twisted pair (STP) Ethernet cable.
- Try replacing the Ethernet cable.
- When you reset all the camera settings, all network settings are lost as well.
- Check that the network device to which the camera is connected is on and functioning properly. To use 1000BASE-T connection speeds, make sure to use network devices compatible with Gigabit Ethernet (1000BASE-T).

The Browser Remote application will not start on the Web browser.

- Make sure to use a connection setting with the [Browser Remote] function setting.
- The URL entered into the Web browser's address bar is incorrect. Select **MENU** > [Network Settings] > [Connection Setting] > Connection setting in use > [Check Settings] and check the camera's IP address. Use this IP address as the URL (☐ 184).

The Browser Remote screen is not displayed correctly on the Web browser.

- The device, operating system or Web browser used may not be supported. For the latest information about supported systems, visit your local Canon website.
- Enable JavaScript and cookies in your Web browser's settings. For details, refer to the help modules or online documentation of the Web browser used.

Cannot start IP streaming.

- Make sure IP streaming was activated on the camera (☐ 182).
- If the IP streaming protocol is set to an option other than [RTSP+RTP], make sure the [Destination Server] is set correctly (☐ 169).
- IP streaming is not possible in the following cases.
 - When using slow & fast motion recording, pre-recording, frame recording, interval recording or the second card recording functions.
 - When the recording format for the main clip is set to MP4 (HEVC).
 - When using the camera as a web camera.

Cannot connect to a smartphone.

- Connect the camera and the smartphone to the same network if they are connected to different networks.
- Enable the tethering (sharing a mobile connection) function on the smartphone if it is disabled.

Cannot connect the optional XC Protocol compatible Remote Camera Controller / Remote Camera Control Application / Multi-Camera Control.

- Make sure to use a connection setting with the [XC Protocol] function setting.
- Check that the settings on the Remote Camera Controller / Remote Camera Control Application / Multi-Camera Control that the camera is trying to connect with are correct.

Precautions Regarding Wi-Fi Networks

When using a Wi-Fi network, try the following corrective actions if the transmission rate drops, the connection is lost, or other problems occur.

Positioning a network device (access point, mobile device, etc.)

- When using a Wi-Fi network indoors, place the network device in the same room as the camera.
- Place the network device in an open, unobstructed location, where people or objects do not come between it and the camera.
- Place the network device as close as possible to the camera. Change the height or facing of the network device, as necessary.

Nearby electronic devices

- If the transmission rate over a Wi-Fi network drops because of interference from the following electronic devices, switching to the 5 GHz band or to a different channel may solve the problem.
- Wi-Fi networks using the IEEE 802.11b/g/n protocol operate in the 2.4 GHz band. For this reason, the transmission rate may drop if there are nearby microwave ovens, cordless telephones, wireless microphones and Bluetooth or similar devices operating on the same frequency band.
- If another access point operating on the same frequency band as the camera is used nearby, the transmission rate may drop.

Using multiple cameras/access points

- Check that there are no IP address conflicts among the devices connected to the same network.
 - If multiple cameras are connected to a single access point, connection speeds may be reduced.
 - To reduce radio wave interference when there are multiple access points using IEEE 802.11b/g or IEEE 802.11n (in the 2.4 GHz band), leave a gap of four channels between each wireless access point. For example, use channels 1, 6, and 11, channels 2, 7, and 12, or channels 3, 8, and 13.
- If you can use IEEE 802.11a/n/ac (in the 5 GHz band), switch to IEEE 802.11a/n/ac and specify a different channel, leaving an appropriate gap between channels according to the wireless standard and frequency band used. For example, when using IEEE 802.11ac (VHT80), leave a gap of 8 channels between access points.

List of Messages

Refer to this section if a message appears on the screen. The messages in this section appear in alphabetical order. Note that for some messages, an indication of the card involved ([SD Card A], [SD Card B] or [SD Card]) may appear above the message itself.

Media full

- The card is full. Replace the card or delete recordings (☐ 144) to free some space on the card.
- Recording will not start because the card is full. Switch to the card in the other card slot to record.

Media is almost full

- Available space on one or both cards is insufficient as described below. Replace the relevant card(s) or delete recordings (☐ 144) to free some space on the card.
 - During normal recording, the space available on the card being used for recording is low.
 - During relay recording, the combined space available on cards A and B is low.
 - During sub recording or double slot recording, the space available on card A or B (the fullest one) is low.
 - During proxy recording, the space available on card A (primary clips) is low. Otherwise, when recording only on card B (proxy clips), the space available on card B is low.
 - During audio recording, the space available on card A (primary clips) is low. Otherwise, when recording on card B (audio recording), the space available on card B is low.
 - During continuous recording, the space available on card B (continuous) is low.

Accessing <...> Do not remove

- You opened the card compartment cover while the camera was recording on the card. Be sure to stop the recording before removing the card.

The following settings were changed.

- The settings displayed on the screen were changed automatically due to a change in one of the [⚙️ Recording/Media Setup] settings. Check the settings before you continue recording.

An error has occurred Turn the camera off, then on again

- An error has occurred. Turn off the camera. If the error persists, when the error message appears, turn off the camera while you press and hold the MENU button. All the camera's settings will be reset except for the hour meter. Turn on the camera again.

Memory card is write-protected

- The LOCK switch on the SD card is set to prevent accidental erasure. Change the position of the LOCK switch.

Check the memory card

- Cannot access the card. If the card is correctly inserted, remove it. Check it has no defects or other problems and then reinsert it.
- A card error occurred and recording/playback is not possible. Try removing and reinserting the card or replace it.
- You inserted a MultiMedia Card (MMC) into the camera. Use a recommended SD card (☐ 31).
- If after the message disappears, [A] or [B] appears in red, perform the following: Turn off the camera and remove and reinsert the card. If [A] or [B] turns back to green you can resume recording/playback. If the problem persists, save your recordings and initialize the card (☐ 32).

No photos

- There are no photos on the SD card.

Cover is open

- The card compartment cover was open when the camera was turned on or switched to CAMERA mode. Insert a card and close the card compartment cover.

Management file error

- Cannot record because the camera cannot write to the file control information. This may occur if the files on the card were accessed using another device. Save your recordings and initialize the card (☐ 32).

Recording was stopped.

- The file control information is corrupted or there was an encoder error. Turn the camera off and then on again. Then, remove the card being used and reinsert it. Alternatively, replace the card. If this does not solve the problem, consult a Canon Service Center.

* Corrupted file control information cannot be recovered. Cards or XF-AVC clips with corrupted file control information cannot be read by the software (Canon XF Utility or plugins for NLE applications).

No clips

- There are no clips of the selected video format on the selected card.

Number of clips already at maximum

- The card selected for recording already contains the maximum number of clips (999 clips). Replace the card or use the card in the other card slot.
- Because both cards reached the maximum number of clips, double slot recording is not available.

The memory card is not compatible with the current recording settings.

- One of the following recording settings was used with a card with a video speed class lower than V90. Change to a V90 card.
 - Slow & fast motion recording mode is activated and the frame rate selected is for slow recording.
 - The recording format was set to [XF-AVC YCC422 10 bit] with a resolution of [3840x2160 Intra-frame] and a frame rate of [59.94P] / [50.00P].
- One of the following recording settings was used with a card with a video speed class lower than V60. Change to a V60 or V90 card.
 - The recording format was set to [XF-AVC YCC422 10 bit] with a resolution of [3840x2160 Intra-frame] and a frame rate other than [59.94P] / [50.00P].
 - The recording format was set to [XF-AVC YCC422 10 bit] with a resolution of [3840x2160 Long GOP] or [1920x1080 Intra-frame].
 - The recording format was set to [MP4(HEVC)YCC422 10 bit] with a resolution of [3840x2160].

With the current [Gamma/Color Space] settings, setting the main recording format to one of the 10 bit options is recommended.

- The main recording format is set to one of the options using 8 bit color but the color space component of the [Gamma/Color Space] setting in the custom picture file is set to [C.Gamut] or [BT.2020]. Using a 10 bit color bit depth is recommended to fully realize the characteristics of the selected color space.

May not be possible to record clips on this media

- The card used does not meet the camera's requirements. Use a recommended card (☞ 31).

If you change this setting, you will not be able to use the current Look File.

- The Look File's adjustments to the image quality cannot be applied because the [Gamma/Color Space], [HLG Color], [Over 100%] settings in the custom picture file are different from those registered with the Look File. Change these settings or register a different Look File.

This photo cannot be displayed

- You may not be able to display photos taken with other devices or image files created or edited on a computer.

Cannot play back

- The XF-AVC clip's file control information is corrupted or there was a decoder error. Turn the camera off and then on again. If this does not solve the problem, consult a Canon Service Center.
 - * Corrupted file control information cannot be recovered. Cards or XF-AVC clips with corrupted file control information cannot be read by the software (Canon XF Utility or plugins for NLE applications).
- Playback was stopped because the card's read speed was too slow. Use a recommended card for recording/playback (☞ 31).

Some clips require data recovery

- The power may have been suddenly turned off or the card may have been removed while the camera was recording. As a result, one or more clips contain corrupted data. You can try to recover the clips (☞ 34).

Some audio files require data recovery.

- The power may have been suddenly turned off or the card may have been removed while the camera was recording. As a result, one or more audio files contain corrupted data. You can try to recover the files (☞ 34).

The sound of the camcorder zooming may also be recorded

- When you use the zoom while **MENU** > [**Camera Setup**] > [Zoom Speed Level] is set to [High], the zoom motor's operation sound may be picked up in the recording. Change the zoom speed level to avoid this (☞ 71).

INFRARED switch position changed (ON/OFF). Check the focus.

- The focus may change when you turn the infrared mode on or off. Check that the focus is correct.

Invalid operation

- The following are not valid operations and cannot be performed.
 - In MEDIA mode, during playback, trying to add a shot mark to a frame that has one already.
 - Trying to add an **OK** mark and a **✓** mark to the same clip.
 - Pressing the REC button when no cards are inserted in the camera.

Recommend checking the data and initializing

- The card cannot be used for any of the following reasons. Save your recordings and initialize the card (☞ 32).
 - A problem has occurred with the card.
 - The camera cannot read the data on the card.
 - The card was initialized using a computer.
 - The card is partitioned.

Low Power Warning Check the power supply.

- The input power supplied to the camera (DC IN terminal) has reached the level set for the power level warning (☞ 207). Check the power source.
- The message appears every time you press the REC button when the power supply is too low (as described above).

Battery communication error. Does this battery display the Canon logo?

- You attached a battery pack that is not recommended by Canon for use with this camera.
- If you are using a battery pack recommended by Canon for use with this camera, there may be a problem with the battery pack or camera. Consult a Canon Service Center.

Buffer overflow. Recording was stopped.

- Recording was stopped because the card's write speed was too slow. Use a recommended card (☞ 31).
- Save your recordings and initialize the card (☞ 32).

File name error

- XF-AVC clip numbers or MP4 clip/photo numbers have reached their maximum value. Save your recordings and initialize the card (☞ 32) or delete all the recordings (☞ 144).

Fan error

- The cooling fan may not be working properly. The camera will turn off automatically after a few minutes. Consult a Canon Service Center.

Recorded at 50.00 Hz/59.94 Hz Recommend checking the data and initializing

- The card contains clips that were recorded using a system frequency different from the one currently used by the camera. To record on this card, save your recordings and initialize the card with the camera (☞ 32). To play back the XF-AVC clips recorded on the card, change the camera's system frequency (☞ 54) to match the recordings on the card.

60 minutes have elapsed. Audio (WAV) recording will stop.

- Recording of the audio file will stop after 60 minutes but video recording will continue unaffected.

SD Card A→SD Card B / SD Card B→SD Card A Switched

- This message appears when you use the SLOT SELECT button to switch the card slot in use or recording continued from one card to the other.

SD Card A→SD Card B / SD Card B→SD Card A Will switch in a moment

- The card is almost full so recording will continue on the other card in approximately 1 minute.

Cannot switch SD card slots

- The SLOT SELECT button was pressed while the camera is recording. Wait until recording is finished to change the selected card slot.

Number of Shot Marks at maximum

- The shot mark could not be added because the clip already contains 100 shot marks.

No WAV files

- There are no WAV files saved on the SD card. Playback is possible once WAV files have been recorded.

Network Functions

Along with this list, refer also to the instruction manuals of the access point or other external devices you are using.

No response from access point.

- Check that the access point is working properly.
- Refer to *Precautions Regarding Wi-Fi Networks* (□ 223) and check if there are applicable steps you can take.

Unable to connect to access point.

- The camera's encryption method is different from that of the access point. Change the settings on the camera to match the access point.

Unable to connect to access point. Retry from the beginning.

- To configure a new network connection using the WPS function (push button method), refer to the access point's instruction manual and check how to activate the WPS function on the wireless router.

Ethernet connection lost.

- You attempted to use an Ethernet (wired) network connection but the Ethernet cable is not connected. Check that the Ethernet cable is correctly connected to the camera and to the network device.
- Check that any network hubs, routers and servers are turned on and working properly.

The camera's temperature is too high.

Network connection terminated.

- The network connection has been lost because the internal temperature of the camera is too high. Turn off the camera and let it cool down before using it again.

No connectable device found

- Check that the Content Transfer Mobile is open.
- Check that the camera and the smartphone are connected to the same network.

No Wi-Fi network found with the selected SSID.

- Check the access point's SSID (network name) and make sure the same name is used in the camera's settings.
- Check that the access point is working properly and try again.

Error code returned from the FTP server for the data session.

- The FTP server terminated the connection. Restart the FTP server.
- Change the file access permission settings on the FTP server to allow reading, writing and accessing logs.
- Allow access permissions to the selected destination folder on the FTP server.
- Check that the FTP server is turned on and working properly.
- Check that there is enough available space on the storage device (hard disk drive, etc.)

Security of server connection cannot be verified. To always trust this server and connect, set [Trust Destination Server] to [Enable].

- Check that the necessary certificate is correctly configured.
- To trust and use this server even without the proper certificate, set [Trust Destination Server] to [Enable].

Another device with the same IP address already connected to the network.

- Another device on the same network has the same IP address as the camera. Change the IP address of the conflicting device or the camera.
- When using a network with a DHCP server, if the camera's IP address assignment is set to [Manual Setting], change it to [Automatic Setting] (□ 174).

Multiple access points detected. Unable to connect. Retry from the beginning.

- Other Wi-Fi devices are using the WPS function (push button method) to connect. Try the operation again or use other methods to configure the network (□ 171).

Another device has set the same IP address.

- Another device on the same network has the same IP address as the camera. Change the IP address of the conflicting device or the camera.

A user with the same login name is already accessing the camera.

- This message appears on the screen of the connected device. Another device connected to the network is already operating the camera. To use this device, first end the connection on the device accessing the camera.

No address assigned by the DHCP server.

- The camera is set to automatic IP address assignment. If the selected network does not use a DHCP server, change the camera's IP address assignment to [Manual Setting] and configure the IP address (☐ 174).
- Check the DNS server.
 - Check that the DHCP server is turned on and working properly.
 - Make sure the DHCP server has enough IP addresses to assign.
- Check the network.
 - Check if a router with an active gateway function is not being used on the network you are trying to connect to.
 - Set the correct gateway address on the camera and on all the devices connected to the same network.
 - Contact the network's administrator and obtain the correct gateway address. Enter the same address in the camera's network settings.

No response from DNS server.

- The camera is set to automatic IP address assignment. If the selected network does not use a DNS server, change the camera's DNS address to [Disable] and configure the IP address (☐ 174).
- Enter the same IP address of the DNS server used in the camera's network settings.
- Check the DNS server.
 - Check that the DNS server is turned on and working properly.
 - On the DNS server, set the correct IP address and the name corresponding to the same address.
- Check the network.
 - Check if a router with an active gateway function is not being used on the network you are trying to connect to.
 - Contact the network's administrator and obtain the correct gateway address. Enter the same address in the camera's network settings.
 - Set the correct gateway address on the camera and on all the devices connected to the same network.

Connection refused by FTP server.

- The FTP server is set to allow connections only with specific IP addresses. Check the camera's IP address (☐ 175), and add it to the FTP server's permission list settings.

Unable to disconnect from FTP server. Error code returned.

- The camera could not disconnect from the FTP server for an unknown reason. Turn the camera and FTP server off and then on again.

File transfer completion was not confirmed by FTP server.

- The camera did not receive a transfer completion notification from the FTP server for an unknown reason. Turn the camera and FTP server off and then on again and try the file transfer again.

Unable to connect to FTP server.

- Enter the correct address for the FTP server in the camera's network settings.
- The authentication method is set to [Open System] but the encryption key is incorrect. Check uppercase/lowercase letters and other characters and make sure to enter the correct encryption key.
- The default port number is 21 (or 22 for SFTP transfers). Check the FTP server's port number and enter the same port number in the camera's network settings.
- Check that the server name of the selected FTP server is correctly configured on the DNS server and that the same name is used also in the camera's network settings.
- Check the FTP server.
 - Check that the FTP server is turned on and working properly.
 - Check that the correct IP address assigned to the FTP server is the same as the FTP server's IP address in the camera's network settings.
 - Access to the FTP server may be protected by a firewall due to security software or broadband routers. Change the firewall's settings to allow connection to the FTP server.
 - You may be able to access the FTP server by setting the camera's passive mode to [Enable] (☐ 167).
 - Contact the network's administrator and obtain the correct IP address and port number for the FTP server. Enter the same information in the camera's network settings.
- Check the network.
 - Check if a router with an active gateway function is not being used on the network you are trying to connect to.
 - Contact the network's administrator and obtain the correct gateway address. Enter the same address in the camera's network settings.
 - Set the correct gateway address on the camera and on all the devices connected to the same network.

Unable to connect to FTP server. Error code returned.

- The maximum number allowed of connections to the FTP server was reached. Reduce the number of network devices connected to the FTP server or increase the number of connections allowed.

Unable to log in to FTP server. Error code returned.

- Check the FTP server's [User Name] and [Password] in the camera's network settings.
- Change the file access permission settings on the FTP server to allow reading, writing and accessing logs.
- Change the destination folder so the path includes only ASCII characters.

Wi-Fi error. Incorrect encryption method.

- Make sure the camera and access point are using the same authentication/encryption method.

Wi-Fi connection lost.

- The camera could not connect to the access point or network device.
- The wireless signal may be affected by nearby cordless telephones, microwave ovens, refrigerators or other devices. Operate the camera in a place more distant from such interference.



Wi-Fi authentication unsuccessful

- The camera's authentication mode and/or encryption key are different from those of the access point. Change the settings on the camera to match the access point.

Incorrect Wi-Fi password.

- Set the correct encryption key on the camera and the access point.

A streaming error occurred.

- Connection to the decoder or computer failed while the SRT protocol is in Caller mode. Set the decoder or computer to reception waiting state, then set [ Network Settings] > [Activate IP Streaming] to [Enable] again ( 182).

Handling Precautions

230

Camera

Be sure to observe the following precautions to ensure maximum performance.

- Do not use or store the camera in dusty or sandy places. The camera is not waterproof – avoid also water, mud or salt. If any of the above should get into the camera it may damage the camera and/or the lens. Consult a Canon Service Center as soon as possible.
- Be careful to avoid dust and dirt particles accumulating on the lens or entering the camera. When you finish using the camera, make sure to attach the body cap to the lens mount and the lens cap and dust cap to the lens.
- Do not use the camera near strong electromagnetic fields such as near powerful magnets and motors, MRI machines or high-voltage power lines. Using the camera in such places may cause anomalies in the video, or audio/video noise. When not using the viewfinder, attach the viewfinder cap to the viewfinder.
- Do not point the camera/viewfinder toward an intense light source, such as the sun on a sunny day or an intense artificial light source. Doing so may damage the image sensor or the camera's internal components. Be especially careful when using a tripod. When you are not using the camera, make sure to attach the lens cap to the lens. When not using the viewfinder, attach the viewfinder cap to the viewfinder.
- Do not carry the camera by the LCD monitor or store the camera in a forced position, without returning the LCD monitor to its correct position. This may damage to the monitor's joints.
- Do not apply excessive force when touching the screen. This may cause irregularities in the display quality or damage to the monitor's joints.
- Do not apply protective film to the touch screen. The camera features a capacitive touch screen that may stop working correctly with a protective overlay.

Long-term storage

If you do not intend to use the camera for a long time, store it in a place free of dust, in low humidity, and at temperatures not higher than 30 °C (86 °F).

Battery Pack

DANGER!

Treat the battery pack with care.

- Keep it away from fire (or it might explode).
- Do not expose the battery pack to temperature higher than 60 °C (140 °F). Do not leave it near a heater or inside a car in hot weather.
- Do not try to disassemble or modify it.
- Do not drop it or subject it to shocks.
- Do not get it wet.

- Dirty terminals may cause a poor contact between the battery pack and the camera. Wipe the terminals with a soft dry cloth.

- Be sure to attach the terminal cover (Figure 1) to transport or store the battery pack. Do not allow any metal objects to touch the terminals (Figure 2), as this can cause a short circuit and damage the battery pack.
- Deplete the battery pack completely before charging it fully. The correct time may not be displayed if a fully charged battery pack is used continuously in high temperatures or is left unused for long periods of time. Also, the correct remaining time may not be displayed, depending on the battery life. Use the time shown on the screen as an approximation.
- The battery terminal cover has a []-shaped hole. This is useful when you wish to differentiate between charged and uncharged battery packs.
- You can use the battery charger and AC adapter to charge battery packs in any country/region with power supply between 100 and 240 V AC, 50/60 Hz. Consult a Canon Service Center for information on plug adapters for overseas use.

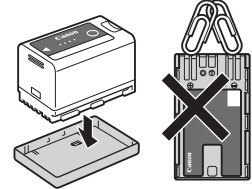

Figure 1

Figure 2

Long-term storage

- Store battery packs in a dry place at temperatures no higher than 30 °C (86 °F).
- To extend the battery life of the battery pack, deplete it completely before storing it.
- Charge and deplete all your battery packs fully at least once a year.

Recording Media

- Periodically backing up recordings from the cards used to a computer is recommended. Data may be corrupted or lost due to defects or exposure to static electricity. Canon shall not be liable for lost or corrupted data.
- Do not touch or expose the terminals to dust or dirt.
- Do not use cards in places subject to strong magnetic fields.
- Do not leave cards in places subject to high humidity and high temperature.
- Do not attach any labels or stickers on the cards.
- Do not disassemble, bend, drop, or subject cards to shocks and do not expose them to water.

Disposal

When you delete data on a card, only the file allocation table is altered and stored data is not physically erased. Take the necessary precautions when you dispose of the card, for example by physically damaging it to prevent the leakage of private data.

If giving the card to another person, initialize it. Fill it up with unimportant recordings, and then initialize it again. This makes recovering the original recordings very difficult.

Built-in Backup Battery

The camera has a built-in rechargeable lithium battery to keep the date/time and other settings. The built-in backup battery is recharged while you use the camera; however, it will be depleted completely if you do not use the camera for about 3 months.

To recharge the built-in backup battery: Turn off the camera and attach a power source (sufficiently charged battery or DC IN terminal). The built-in backup battery will be fully charged in approx. 24 hours.

Maintenance/Others

Condensation

232

Moving the camera rapidly between hot and cold temperatures may cause condensation (water droplets) to form on its internal surfaces. Stop using the camera if condensation is detected. Continued use may damage the camera. Condensation may form in the following cases:

- When the camera is moved quickly from cold to warm places
- When the camera is left in a humid room
- When a cold room is heated rapidly

When condensation is detected

The precise time required for water droplets to evaporate will vary depending on the location and weather conditions. As a general rule, wait for 2 hours before resuming use of the camera.

To avoid condensation

Remove the battery pack and any cards. Then, place the camera in an airtight plastic bag and let it adjust gradually to temperature changes before removing it from the bag.

Cleaning

Camera body

- Use a soft dry cloth to clean the camera's body. Never use chemically treated cloths or volatile solvents such as paint thinner.

Lens

- Remove any dust or dirt particles using a non-aerosol type blower.
- Use a clean, soft lens-cleaning cloth to gently wipe the lens. Never use tissue paper.

LCD screen

- Clean the LCD screen using a clean, soft lens-cleaning cloth and commercially available cleaning fluid for eyeglasses.
- Condensation may form on the surface of the screen when the temperature changes suddenly. Wipe it with a soft dry cloth.

Optional Accessories

The following optional accessories are compatible with this camera. The availability differs from area to area. For details about compatible optional accessories, refer to their respective instruction manuals and the **XF/XA System Expansion User Guide** (PDF file), available from your local Canon website.

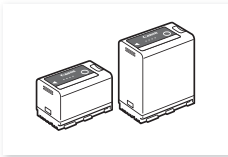

BP-A30, BP-A60
Battery Pack¹

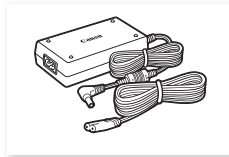

CA-CP200 L Compact Power Adapter

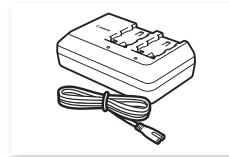

CG-A10 Battery Charger

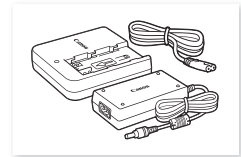

CG-A20 Battery Charger and
CA-CP200 B Compact
Power Adapter

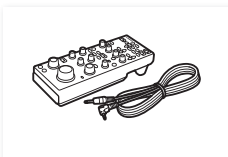

RC-V100
Remote Controller

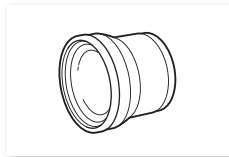

TL-U58
Tele-converter

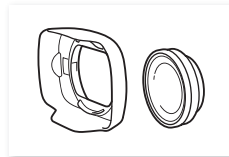

WA-U58
Wide Attachment



GP-E2 GPS Receiver²

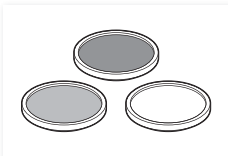

Protect Filter 58 mm,
ND4L Filter 58 mm,
ND8L Filter 58 mm

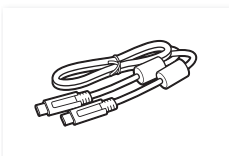

IFC-100U Interface Cable



IFC-40AB III / IFC-150AB III
Interface Cable

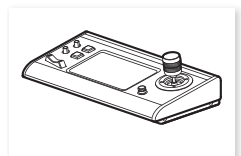

RC-IP100
Remote Camera Controller³



RC-IP1000 Remote Camera
Controller³

¹ These battery packs are compatible with Intelligent System. The camera can communicate with the battery pack and display a more accurate approximate remaining usage time (in minutes).

² An optional IFC-40AB III/IFC-150AB III Interface Cable is required for a wired connection between this accessory and the camera.

³ This is a class A product. In a domestic environment this product may cause radio interference in which case the user may be required to take adequate measures.

For our customers in the USA: Call or visit your local retailer/dealer for genuine Canon video accessories. You can also obtain genuine accessories for your Canon camera by calling: 1-800-828-4040, Canon U.S.A. Information Center.

! IMPORTANT

• **Use of genuine Canon accessories is recommended.**

The message [Battery communication error] is displayed if you use a non-genuine Canon battery pack, and user response is required. Note that Canon shall not be liable for any damages resulting from accidents, such as malfunction or fire, that occur due to use of non-genuine Canon battery packs.



This mark identifies genuine Canon video accessories. When you use Canon video equipment, we recommend Canon-brand accessories or products bearing the same mark.

Specifications

XF605

System

- Recording System

Clips:

XF-AVC

Video compression: MPEG-4 AVC / H.264
 Audio format: Linear PCM, 24 bit, 48 kHz, 4 channels
 File format: MXF

MP4

Video compression: H.265 / HEVC, MPEG-4 AVC / H.264
 Audio format: Linear PCM, 16 bit, 48 kHz, 4 channels
 MPEG-2 AAC-LC, 16 bit, 48 kHz, 2 channels
 File format: MP4

WAV

Audio format: Audio files for slow & fast motion recording
 Linear PCM, 24 bit, 48 kHz, 4 channels
 Audio files for second card recording functions
 Linear PCM, 16 bit, 8 kHz, 1 channel
 File format: BWF

Photos: DCF (Design rule for Camera File system), compatible with Exif Ver. 2.31, JPEG compression

- Video Configuration (recording/playback)

Primary clips:

XF-AVC

Bit rate: 600 Mbps, 500 Mbps, 410 Mbps, 310 Mbps, 300 Mbps, 250 Mbps, 240 Mbps,
 160 Mbps / Intra-frame
 260 Mbps, 160 Mbps, 50 Mbps, 25 Mbps, 24 Mbps / Long GOP
 Resolution: 3840x2160, 1920x1080, 1280x720
 Color sampling: YCbCr 4:2:2, 10 bit
 Frame rate: 59.94P, 59.94i, 50.00P, 50.00i, 29.97P, 25.00P, 23.98P

MP4

Bit rate: 225 Mbps, 170 Mbps, 150 Mbps, 135 Mbps, 100 Mbps, 50 Mbps, 35 Mbps,
 12 Mbps, 9 Mbps, 8 Mbps / Long GOP
 Resolution: 3840x2160, 1920x1080, 1280x720
 Color sampling: YCbCr 4:2:2, 10 bit, 4:2:0, 10 bit, 4:2:0, 8 bit
 Frame rate: 59.94P, 50.00P, 29.97P, 25.00P, 23.98P

Sub recording clips:

XF-AVC

Bit rate: 310 Mbps, 300 Mbps, 250 Mbps, 240 Mbps, 160 Mbps / Intra-frame,
 160 Mbps, 50 Mbps, 24 Mbps / Long GOP
 Resolution: 3840x2160, 1920x1080, 1280x720
 Color sampling: YCbCr 4:2:2, 10 bit
 Frame rate: 59.94P, 59.94i, 50.00P, 50.00i, 29.97P, 25.00P, 23.98P

MP4

Bit rate: 150 Mbps, 100 Mbps, 50 Mbps, 35 Mbps, 12 Mbps, 9 Mbps,
 8 Mbps / Long GOP
 Resolution: 3840x2160, 1920x1080, 1280x720
 Color sampling: YCbCr 4:2:2, 10 bit, 4:2:0, 10 bit, 4:2:0, 8 bit
 Frame rate: 59.94P, 50.00P, 29.97P, 25.00P, 23.98P

Proxy clips:

XF-AVC

Bit rate:	35 Mbps, 24 Mbps, 17 Mbps / Long GOP
Resolution:	1920x1080, 1280x720
Color sampling:	YCbCr 4:2:0, 8 bit
Frame rate:	59.94P, 59.94i, 50.00P, 50.00i, 29.97P, 25.00P, 23.98P

MP4

Bit rate:	16 Mbps, 9 Mbps, 6 Mbps, 4 Mbps / Long GOP
Resolution:	1920x1080, 1280x720
Color sampling:	YCbCr 4:2:0, 8 bit
Frame rate:	59.94P, 50.00P, 29.97P, 23.98P, 25.00P

Chunk recording clips:

MP4

Bit rate:	16 Mbps / Long GOP
Resolution:	1920x1080
Color sampling:	YCbCr 4:2:0, 8 bit
Frame rate:	59.94P, 50.00P

• **Recording Media (not included)**

SD, SDHC (SD High Capacity) or SDXC (SD eXtended Capacity) cards

• **Image Sensor**

Type 1.0 (1.0 in.) single-plate CMOS sensor

Effective pixels (approximate): 8,290,000 pixels (3840x2160)

• **LCD Touch Screen**

8.8 cm (3.5 in.) color LCD, 16:9 aspect ratio, approx. 2,760,000 dots, 100% coverage, capacitive touch screen operation

- View assistance (Gamma: equivalent to BT.709 Wide DR / equivalent to CMT 709 / original, Color space: equivalent to BT.709).
- Assistance displays can be output (onscreen displays, peaking, zebra pattern, magnification, B&W image, video scope, false color).

• **Viewfinder:** 0.92 cm (0.36 in.) organic LED display, approx. 1,770,000 dots, 100% coverage

- View assistance (Gamma: equivalent to BT.709 Wide DR / equivalent to CMT 709 /original, Color space: equivalent to BT.709).
- Assistance displays can be output (onscreen displays, peaking, zebra pattern, magnification, B&W image, video scope, false color).

• **Lens**

f=8.3 – 124.5 mm, F/2.8 – 4.5, 15x optical zoom, 9-bladed iris diaphragm

35mm equivalent focal length: approx. 28.3 – 424.6 mm (Dynamic IS)

approx. 25.5 – 382.5 mm (other IS modes)

• **Lens Configuration:** 18 elements in 14 groups (including 2 aspheric elements)

• **Filter Diameter:** 58 mm

• **Minimum Focusing Distance**

60 cm (2 ft.) throughout the zoom range; 1 cm (0.39 in.) at full wide angle

• **Shutter Speed**

Automatic, speed (1/3-stop increments, 1/4-stop increments), angle, clear scan, slow, off

• **Iris**

Manual (1/3-stop increments, 1/4-stop increments, fine adjustment available), push auto iris, automatic aperture

- **ISO Speed/Gain**
Manual, automatic adjustment
ISO Speed: ISO200 to ISO12800
Gain: -6 dB to 21.0 dB
- **ND Filter**
Built-in (Off, 1/4, 1/16, 1/64), motor operated
- **Exposure**
AE shift, light metering modes (standard, spotlight, backlight)
- **White Balance**
Custom white balance (two sets, A and B); two preset settings (daylight, 5,600 K¹ and tungsten lamp, 3,200 K¹); color temperature setting (2,000 K to 15,000 K); automatic white balance (AWB)
Color temperature and color compensation (CC) adjustment available for all settings except custom white balance and AWB.
¹ Color temperatures are approximate and given only as a reference.
- **Focus**
Manual focus, autofocus (AF-boosted MF, continuous AF, Face AF); face detection and subject tracking available
AF type: Dual Pixel CMOS AF, contrast-detection AF
- **Image Stabilization**
Optical-shift image stabilizer + digital compensation (Standard IS, Dynamic IS, Powered IS)
- **Sensor Sensitivity (2000 lux, 89.9% reflection, [High Sensitivity Mode] set to [On])**
59.94 Hz: F12 (at 59.94P)
50.00 Hz: F13 (at 50.00P)
- **Infrared mode:** Available, including built-in infrared light
- **Wi-Fi**
Wireless Standard: IEEE802.11b/g/n (2.4 GHz band), IEEE802.11a/n/ac (5 GHz band)
Connection Methods:
Infrastructure (Wi-Fi Protected Setup (WPS), search for access points, manual), Camera Access Point
Authentication Methods: Open, shared key, WPA-PSK, WPA2-PSK
Encryption Methods: WEP-64, WEP-128, TKIP, AES
- **Built-in Microphone**
Stereo electret condenser microphone
- **Size of Photos**
3840x2160

Terminals

- **SDI OUT Terminal**
BNC jack, output only, 0.8 Vp-p / 75 Ω, unbalanced
Video
 - SD: SMPTE ST 259
 - HD: SMPTE 292
 - 3G: SMPTE 424, SMPTE 425
 - 6G: SMPTE ST 2081
 - 12G: SMPTE ST 2082
 Audio
 - SD: SMPTE ST 272
 - Other than SD: SMPTE ST 299
Embedded audio, time code (VITC/LTC)
- LUTs (BT.709, BT.2020, DCI, PQ, HLG, CMT 709, User LUT 1 to 4).

- Assistance displays can be output (superimposed onscreen displays, peaking, zebra pattern, magnification, B&W display, video scope, false color).
- **HDMI OUT Terminal**
HDMI connector, output only, time code
 - View assistance (Gamma: equivalent to BT.709 Wide DR / equivalent to CMT 709, Color space: equivalent to BT.709).
 - Assistance displays can be output (onscreen displays, peaking, zebra pattern, magnification, B&W image, video scope, false color).
- **INPUT Terminals (INPUT 1 and INPUT 2)**
XLR 3-pin jack (pin1: shield, pin2: hot, pin3: cold), 2 sets, balanced
Sensitivity:
 - MIC setting: -60 dBu (volume center, full scale -18 dB) / microphone attenuator: 20 dB
 - LINE setting: 4 dBu (volume center, full scale -18 dB)
- **MIC Terminal**
Ø 3.5 mm stereo mini-jack
Sensitivity:
 - [MIC], [MIC (with Power Supply)] setting:
 - 72 dBV (volume center, full scale -18 dB) / microphone attenuator: 20 dB
 - Plug-in power supply: 2.5 V DC
 - [LINE] setting: -12 dBV (volume center, full scale -18 dB)
- **G-LOCK/SYNC Terminal**
BNC jack, 1.0 Vp-p / 75 Ω
GENLOCK setting: input only; SYNC OUT setting: output only, tri-level HD signal
- **🎧 (Headphone) Terminal**
Ø 3.5 mm stereo mini-jack, $-\infty$ to -8 dBV (16 Ω load, volume range Min to Max)
- **TIME CODE Terminal**
BNC jack, input/output
Input setting: 0.5 Vp-p to 18 Vp-p / 100 kΩ; Output setting: 1.3 Vp-p / 50 Ω or less
- **USB Terminal**
USB Type-C™ receptacle
- **USB (HOST) Terminal**
USB Type-A receptacle (used for future functionality expansion)
- **REMOTE A Terminal, REMOTE B Terminal**
REMOTE A: Ø 2.5 mm stereo sub-mini jack
REMOTE B: Circular 8-pin jack (for the optional RC-V100 Remote Controller, RS-422 interface)
- **🌐 (Ethernet) Terminal: Ethernet, 1000BASE-T compatible**

Power/Others

- **Power Supply (rated)**
14.4 V DC (battery pack), 24.0 V DC (DC IN)
- **Power Consumption and Approximate Continuous Recording Times**
Values are listed in the following order: Power consumption / Continuous recording time with a BP-A30 battery / Continuous recording time with a BP-A60 battery. The values were measured using normal recording (second card recording function turned off), the LCD monitor ([LCD Luminance] set to [Normal]) and the SDI OUT terminal (3G-SDI).
 - Approx. 14.3 W / 175 min. / 360 min. (XF-AVC, 3840x2160 600Mbps Intra-frame at 59.94P)
 - Approx. 13.9 W / 180 min. / 370 min. (XF-AVC, 3840x2160 500Mbps Intra-frame at 50.00P)
 - Approx. 14.2 W / 175 min. / 365 min. (XF-AVC, 3840x2160 260Mbps Long GOP at 59.94P)
 - Approx. 13.6 W / 185 min. / 380 min. (XF-AVC, 3840x2160 260Mbps Long GOP at 50.00P)

- **Operating Temperature**
0 – 40 °C (32 – 104 °F)
- **Dimensions (W x H x D)²**
Camera body only: 168 x 173 x 333 mm (6.6 x 6.8 x 13.1 in.)
Camera with lens hood, eye cup, microphone holder: 200 x 219 x 385 mm (7.9 x 8.6 x 15.2 in.)
- **Weight² (including grip belt)**
Camera body: 2010 g (4.4 lb.)
Camera with lens hood, eye cup, microphone holder, BP-A30 battery and one SD card: 2460 g (5.4 lb.)

Accessories

CG-A20 Battery Charger

- **Rated Input:** 24 V DC, 1.8 A
- **Rated Output:** 16.7 V DC, 1.5 A
- **Operating Temperature:** 0 – 40 °C (32 – 104 °F)
- **Dimensions² (W x H x D):** 100 x 24 x 100 mm (3.9 x 0.9 x 3.9 in.)
- **Weight²:** 145 g (5.1 oz.)

CA-CP200 L Compact Power Adapter

- **Rated Input:** 100 – 240 V AC, 50/60 Hz, 90 VA (100 V AC) – 120 VA (240 V AC)
- **Rated Output:** 24 V DC, 1.8 A
- **Operating Temperature:** 0 – 40 °C (32 – 104 °F)
- **Dimensions² (W x H x D):** 67.5 x 37 x 134 mm (2.7 x 1.5 x 5.3 in.)
- **Weight²:** 290 g (10.2 oz.)

BP-A30 Battery Pack

- **Battery Type:** Rechargeable lithium ion battery, compatible with Intelligent System
- **Rated Voltage:** 14.4 V DC
- **Rated Battery Capacity:** 3,100 mAh / 45 Wh
- **Operating Temperature:** 0 – 40 °C (32 – 104 °F)
- **Dimensions² (W x H x D):** 41.5 x 45.1 x 69.7 mm (1.6 x 1.8 x 2.7 in.)
- **Weight²:** 225 g (7.9 oz)

² All dimensions and weights are approximate.

Reference Tables

Approximate Recording Time on a Card

Approximate times, for reference only, based on a single recording that continues until the card is full.

Main recording format and bit rate		32 GB	128 GB	512 GB
XF-AVC	600 Mbps	6 min.	27 min.	109 min.
	500 Mbps	8 min.	32 min.	131 min.
	410 Mbps	9 min.	39 min.	156 min.
	310 Mbps	12 min.	51 min.	207 min.
	300 Mbps	13 min.	54 min.	216 min.
	260 Mbps	15 min.	61 min.	246 min.
	250 Mbps	16 min.	64 min.	256 min.
	240 Mbps	16 min.	66 min.	267 min.
	160 Mbps	25 min.	100 min.	401 min.
	50 Mbps	80 min.	321 min.	1,284 min.
MP4 (HEVC)	225 Mbps	16 min.	71 min.	285 min.
	170 Mbps	23 min.	94 min.	377 min.
	135 Mbps	29 min.	118 min.	475 min.
	100 Mbps	40 min.	160 min.	642 min.
	50 Mbps	80 min.	321 min.	1,284 min.
MP4 (H.264)	150 Mbps	25 min.	107 min.	428 min.
	35 Mbps	114 min.	458 min.	1,834 min.

Charging Times

Charging times are approximate and vary according to charging conditions, ambient temperature and initial charge of the battery pack.

Battery pack	BP-A30	BP-A60
Charging time using the supplied CG-A20 Battery Charger	170 min.	300 min.

Appendix: Camera Dimensions

Unless indicated with the " (inch) mark, all units are in mm. √ represents the depth of a hole or socket.

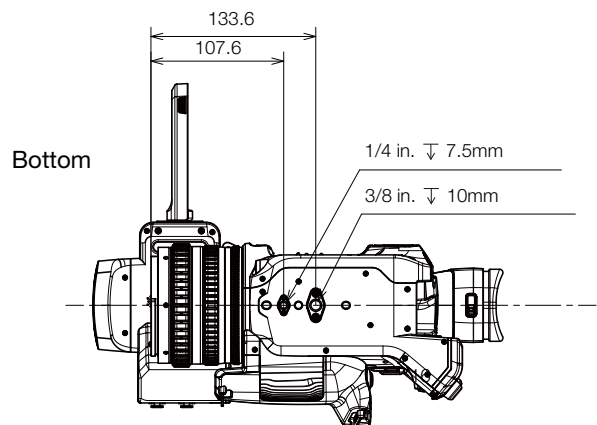
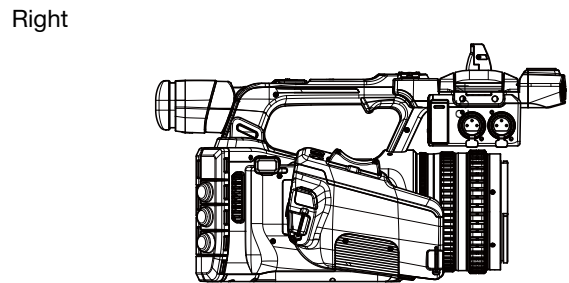
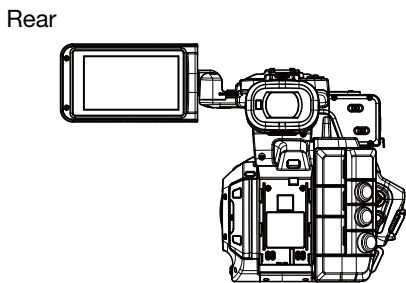
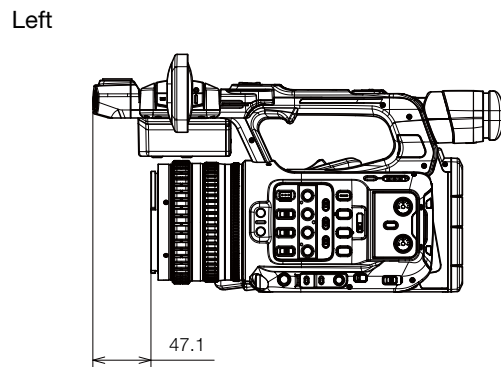
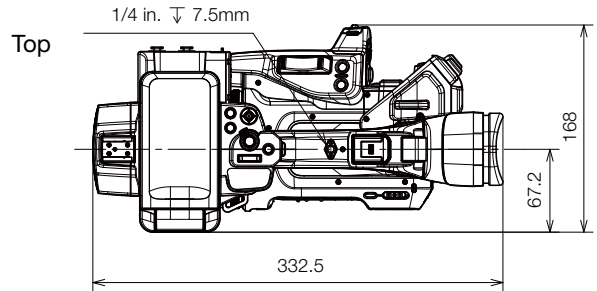
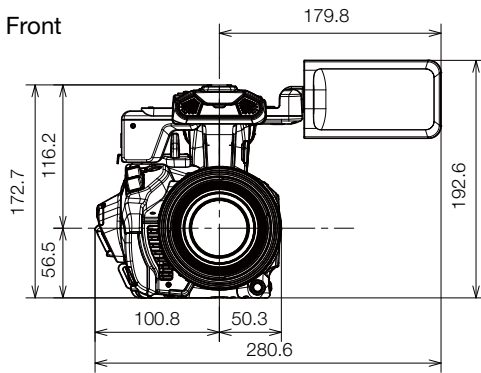

Camera with lens hood, microphone holder and eye cup

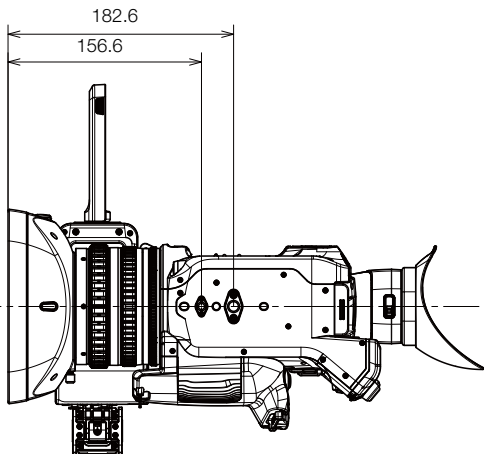
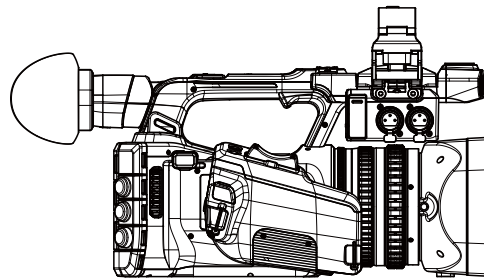
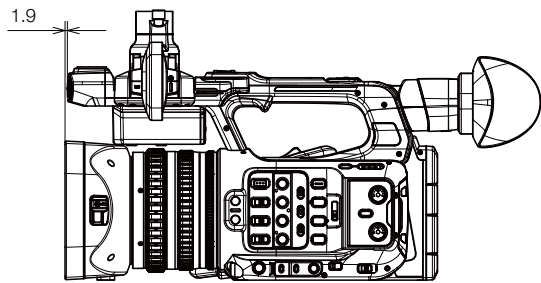
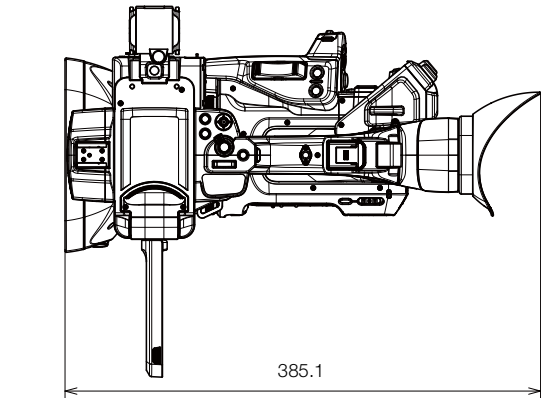
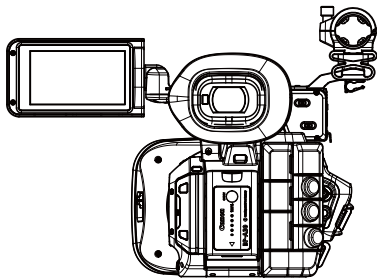
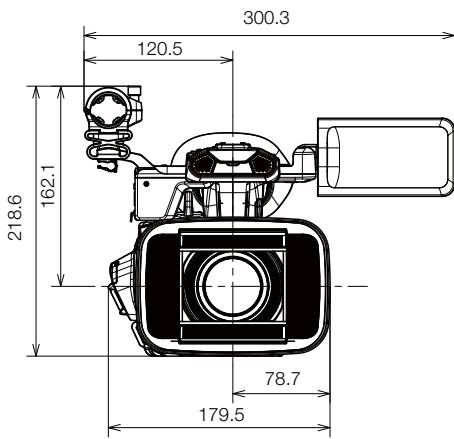

🔊 (headphones) terminal101, 140
 802.1X Authentication175

A

Abroad, using the camera231
 Access point163, 164
 Accessories10, 233
 AE shift67
 Air vents13, 17, 40
 Aperture65
 Automatic aperture (auto iris)65
 Push auto iris65
 Assignable buttons119
 Audio
 Audio level98
 Bit depth94
 Format95
 Output channels159
 Peak limiter99
 Recording94
 Audio files (for slow & fast motion clips)109
 Audio recording35, 95
 Audio reference signal102
 Authentication173, 175
 AWB (auto white balance)69
 AWB lock69

B

Bit rate54
 Browser Remote184
 Built-in backup battery231
 Button connection mode (WPS)164, 167

C

C.Gamut124
 Camera Access Point171
 Camera dimensions241
 Camera nickname175
 Canon App163, 170, 194
 Canon Log 3
 (gamma curves)128
 Canon XF Utility (download)160
 Card volume label33
 Check marks (☑)105, 143
 Chunk recording57

Clips

Adding marks/ marks 105, 143
 Adding shot marks 105, 143
 Clip information 142
 Clip name format 37
 Clip numbering 37, 38
 Deleting 144
 Playback 137
 Proxy clips 55
 Recording 41
 Recovering 34
 Color bars 102
 Color bit depth 54
 Color compensation (CC) value 68
 Color sampling 54
 Color space 128, 154
 Computer 160
 Condensation 232
 Connection to external devices 150
 Content Transfer Mobile 161
 Continuous recording 113
 Conversion lens 75
 Custom displays 43, 201
 Custom picture 124
 Detailed custom picture settings 128
 Look File 126
 Preset settings 124

D

Data entry / keyboard screen 27
 Date and time 24
 DC IN terminal 22, 238
 DCI-P3 154
 Deleting recordings 144
 Detection of access points 173
 Digital tele-converter 71
 Direct setting mode 51
 Direct touch control 50
 Double slot recording 35
 Drop frame (time code) 89
 Dynamic IS 84

- E**
- Encryption172, 173
 - Exposure bar67
 - Exposure compensation67
 - Eye cup30
 - Eye detection81
- F**
- Face detection AF, face detection AE81
 - False color87
 - Fan40
 - FEC error correction169
 - File menu141
 - File names37
 - File numbering (MP4 clips/photos)38
 - File operations141
 - Flicker reduction61
 - Focus76
 - AF-boosted MF79
 - AF speed80
 - Continuous AF80
 - Face-only AF81
 - Focus assistance functions77
 - Focus limit83
 - Manual focus76
 - Tracking83
 - Focus guide77
 - Focus ring (lens)76
 - Frame rate54
 - Frame recording111
 - Frame recording mode111
 - Free-run (time code)88
 - FTP transfer181
 - Full auto mode42
 - Full range/Video range (level mapping)152
 - FUNC button51
- G**
- Gain62
 - Gamma curve128, 154
 - Genlock92
 - G-LOCK/SYNC terminal91
 - GPS information106, 144, 213
 - GPS receiver (optional)44, 207
- H**
- H.264 codec54
 - HDMI OUT terminal145, 151
 - HDR (high dynamic range)128, 154, 158
 - Headphones101, 140
 - HEVC (H.265) codec54
 - HLG (hybrid log gamma)128, 154, 156
 - Hour meter207
 - HTTPS178
- I**
- Image stabilizer84
 - INDEX button136
 - Index screens135
 - Infrared light114
 - Infrared recording114
 - Infrastructure164
 - Initializing a card32
 - INPUT terminals94, 96, 97
 - Interval recording112
 - Interval recording mode112
 - IP address (IPv4 settings)174
 - IP streaming182
 - IPv6 settings177
 - Iris65
 - ISO speed62
- J**
- Joystick25
- K**
- Key lock15
- L**
- Language24
 - LCD monitor23
 - Lens28
 - Lens correction (diffraction)29
 - Lens hood28
 - Lens mount28
 - Light metering mode67
 - Look File126
 - LUT (lookup table)154

M

Macro shooting	83
Magnification	78
Main recording (primary clips)	35, 54
Main recording format	54
Maintenance	232
Manual network configuration	173
Menu settings	133, 195
Message list	224
Metadata	106
MIC terminal	94, 96
Microphone	
External	96, 97
Sensitivity / Attenuator / Low cut filter	100
Microphone holder	28, 96
MP4	53
MP4 Join Tool (download)	160
Multi-Camera Contro	192
Multi-function shoe	30
MXF (file format)	235
My Menu	26

N

ND filter	64
Network	
Communication setting (NW)	166, 176
Configuration	166
Connection setting (SET)	166, 175
Connection status	180
Function setting (MODE)	166, 176
Network functions	163
Network connection	
Wi-Fi	164
Wired (Ethernet)	165
News Metadata	106
Non-drop frame (time code)	89

O

OK marks (OK)	105, 143
Onscreen displays	43, 138
Display level	46
Opacity/transparency	152
Output	151
Peripheral border display	47
Onscreen markers	85
Output range	152

P

Peaking	78
Phantom power (microphone)	97
Photos	
Photo numbering	38
Recording	42
Viewing	137
PIN code connection mode (WPS)	172
Playback	135
Plug-in power (microphone)	97
Portrait mode	48
Portrait orientation (vertical video)	48
Power indicator	14
Power supply	19
AC adapter (DC IN)	22, 238
Canon battery packs	19
Checking power levels/remaining	
battery charge	21, 45, 213
Power level warnings	207
POWER switch	14
Powered IS	84
Pre-recording	111
Progress bar (playback)	138
Proxy recording	55

R

RC-IP100/RC-IP1000	191
RC-V100	115
Real-time streaming (RTSP)	169
REC button	41
Rec Run (time code)	88
Recording	
Photos	42
Primary clips	41
Proxy clips (simultaneous recording)	55
Sub recording clips	
(simultaneous recording)	58
Recording command	151
Recording media	31, 231
Reference tables (charging, usage and	
recording times)	240
Reference video signal input	92
Relay recording	35
Remote Camera Control Application	191
Remote Camera Controller	191
Remote Controller	115

Remote operation	184
Resetting all camera settings	205
Resolution (frame size)	54
Reviewing a clip	49
Root certificate (FTPS)	174
Router	164
Running mode (time code)	88

S

Safe area	85
Saving recordings to a computer	160
SD card	
Compatible cards	31
Initializing	32
Inserting/Removing	32
Recording method	35
Switching card slots	33, 136
SDI OUT terminal	150
Second card recording functions	35
Secure FTP (SFTP, FTPS)	167
Setup menus	25, 195
Shooting frame rate	109
Shot marks	105, 143
Shutter speed	60
Slow & fast motion recording	109
Speaker	16
Special recording modes	109
Specifications	235
SSID	173
Standard IS	84
Status screens	208
Sub recording	58
Synchronization	91
System frequency	54

T

Tally lamp	41
Tally OSD	47
Time code	88
Time code synchronization	91
TIME CODE terminal	91
Tracking	83
Tripod	16
Troubleshooting	218
Turning the camera on/off	14

U

USB (HOST) terminal	13
USB terminal (Type-C)	18
User bit	90
User LUTs	156
User memo	106

V

Vectorscope	104
Video configuration	53
Video format (XF-AVC, MP4)	53
Video output configuration	145
Video recording method	35
Video scopes	103
View assistance	154
Viewfinder	29
Volume	140
Volume label	33

W

WAV audio files	109
Waveform monitor	103
White balance	68
Wide DR	128, 154
WPS (Wi-Fi Protected Setup)	164, 167, 172

X

XC Protocol	191
XF/XA System Expansion User Guide	233
XF-AVC	53

Z

Zebra pattern	87
Zoom	71
Zoom ring	72
Zoom rocker	73

Trademark Acknowledgements

- SD, SDHC and SDXC Logos are trademarks of SD-3C, LLC.
- Microsoft and Windows are trademarks or registered trademarks of Microsoft Corporation in the United States and/or other countries.
- macOS, App Store, iPhone are trademarks of Apple Inc., registered in the U.S. and other countries.
- Avid and Media Composer are trademarks or registered trademarks of Avid Technology, Inc. or its subsidiaries in the United States and/or other countries.
- Wi-Fi is a registered trademark of the Wi-Fi Alliance.
- Wi-Fi Certified, WPA, WPA2, and the Wi-Fi Certified logo are trademarks of the Wi-Fi Alliance.
- WPS as used on the camera's settings, onscreen displays and in this manual signifies Wi-Fi Protected Setup.
- JavaScript is a trademark or registered trademark of Oracle Corporation, its affiliates or subsidiaries in the United States and other countries.
- The terms HDMI, HDMI High-Definition Multimedia Interface, HDMI Trade dress and the HDMI Logos are trademarks or registered trademarks of HDMI Licensing Administrator, Inc.
- USB Type-C™ and USB-C™ are trademarks of USB Implementers Forum.
- DaVinci Resolve™ is the trademark of Blackmagic Design Pty Ltd.
- Other names and products not mentioned above may be trademarks or registered trademarks of their respective companies.

Licensing Information

- This device incorporates exFAT technology licensed from Microsoft.
- This product is licensed under AT&T patents for the MPEG-4 standard and may be used for encoding MPEG-4 compliant video and/or decoding MPEG-4 compliant video that was encoded only (1) for a personal and noncommercial purpose or (2) by a video provider licensed under the AT&T patents to provide MPEG-4 compliant video. No license is granted or implied for any other use for MPEG-4 standard.
- THIS PRODUCT IS LICENSED UNDER THE AVC PATENT PORTFOLIO LICENSE FOR THE PERSONAL USE OF A CONSUMER OR OTHER USES IN WHICH IT DOES NOT RECEIVE REMUNERATION TO (i) ENCODE VIDEO IN COMPLIANCE WITH THE AVC STANDARD ("AVC VIDEO") AND/OR (ii) DECODE AVC VIDEO THAT WAS ENCODED BY A CONSUMER ENGAGED IN A PERSONAL ACTIVITY AND/OR WAS OBTAINED FROM A VIDEO PROVIDER LICENSED TO PROVIDE AVC VIDEO. NO LICENSE IS GRANTED OR SHALL BE IMPLIED FOR ANY OTHER USE. ADDITIONAL INFORMATION MAY BE OBTAINED FROM MPEG LA, L.L.C. SEE [HTTP://WWW.MPEGLA.COM](http://www.mpegla.com)

CANON PROFESSIONAL DIGITAL VIDEO EQUIPMENT LIMITED WARRANTY FOR PRODUCTS PURCHASED IN THE UNITED STATES

The limited warranty set forth below is given by Canon U.S.A., Inc. ("Canon USA") with respect to Canon Professional Digital Video Equipment (the "Equipment") packaged with this limited warranty and purchased in the United States. This limited warranty is only effective upon presentation of your Bill of Sale or other proof of purchase. The Equipment is warranted to the original end-user purchaser, when delivered in new condition in its original container, under normal use against defective materials or workmanship as follows:

Parts: Defective parts will be exchanged for new parts or comparable rebuilt parts for a period of ONE YEAR from the date of original purchase.

Labor: For a period of ONE YEAR from the date of original purchase, labor will be provided free of charge by Canon USA's factory service centers or designated service facilities located in the United States.

When returning Equipment under this warranty, you must pre-pay the shipping charges, and you must enclose a copy of the Bill of Sale or other proof of purchase with a complete explanation of the problem. During the ONE-YEAR warranty period, repairs will be made and the Equipment will be return-shipped to you free of charge. For repairs after the warranty period is over, you will be given an estimate of the cost of repair and an opportunity to approve or disapprove of the repair expense before it is incurred. If you approve, repairs will be made and the Equipment will be returned to you at your risk and expense. If you disapprove, we will return-ship the Equipment to you at no charge to you to an address within the United States.

This limited warranty only applies if the Equipment is used in conjunction with compatible computer equipment and compatible software, as to which items Canon USA will have no responsibility. Canon USA shall have no responsibility under this limited warranty for use of the Equipment in conjunction with incompatible peripheral equipment and/or incompatible software. Non-Canon brand peripheral equipment and software which may be distributed with, or factory loaded on, the Equipment, are sold 'AS IS' without warranty of any kind by Canon USA, including any implied warranty regarding merchantability or fitness for a particular purpose. The sole warranty with respect to such non-Canon brand items is given by the manufacturer or producer thereof. If the Equipment contains a hard disk drive, Canon USA recommends that data stored on that drive be duplicated or backed up to prevent its loss in the event of failure or other malfunction of such drive.

In order to obtain warranty service, please contact the authorized Canon retail dealer from whom you purchased the Equipment or contact the CANON INFORMATION CENTER AT 855-CINE-EOS (855-246-3367) or on the Internet at pro.usa.canon.com/support. You will be directed to the nearest service facility for your Equipment.

This Limited Warranty covers all defects encountered in normal use of the Equipment and does not apply in the following cases:

- A. Loss or damage to the Equipment due to abuse, mishandling, accident, improper maintenance, use of non-Canon accessories or failure to follow operating, maintenance or environmental instructions prescribed in Canon USA's user's manual;
- B. If the Equipment is defective as a result of leaking batteries, sand, dirt or water damage;
- C. If defects or damages are caused by the use of parts or supplies (other than those sold by Canon USA) that cause damage to the Equipment or that cause abnormally frequent service calls or service problems;
- D. If defects or damages are caused by service other than Canon USA's factory service centers or authorized service facilities;
- E. Any internal modification to product hardware or firmware;
- F. Any applicable fee for Maintenance of the Equipment;
- G. If the Equipment has had its serial number or dating altered or removed.

This Limited Warranty does not apply to Equipment purchased outside the United States. This Limited Warranty does not apply to accessories or consumables for the Equipment, which are sold "AS IS", without warranty of any kind by Canon USA. Please retain this warranty card and your Bill of Sale as a permanent record of your purchase. This card ensures that you are contacted promptly should there be a safety inspection, modification or product recall under applicable laws or regulations.

NO IMPLIED WARRANTY, INCLUDING MERCHANTABILITY AND FITNESS FOR A PARTICULAR PURPOSE APPLIES TO THIS EQUIPMENT AFTER THE APPLICABLE PERIOD OF EXPRESS WARRANTY OR GUARANTY (EXCEPT AS MENTIONED ABOVE) GIVEN BY ANY PERSON, FIRM OR CORPORATION WITH RESPECT TO THIS EQUIPMENT SHALL BIND THE UNDERSIGNED (SOME STATES DO NOT ALLOW LIMITATIONS ON HOW LONG AN IMPLIED WARRANTY LASTS, SO THE ABOVE LIMITATION OR EXCLUSION MAY NOT APPLY TO YOU). CANON USA SHALL NOT BE LIABLE FOR LOSS OF REVENUES OR PROFITS, EXPENSE FOR SUBSTITUTE EQUIPMENT OR SERVICE, STORAGE CHARGES, LOSS OR CORRUPTION OF DATA, INCLUDING WITHOUT LIMITATION, LOSS OR CORRUPTION OF DATA STORED ON THE EQUIPMENT'S HARD DRIVE, OR ANY OTHER SPECIAL, INCIDENTAL OR CONSEQUENTIAL DAMAGES CAUSED BY THE USE, MISUSE OR INABILITY TO USE THE EQUIPMENT, REGARDLESS OF THE LEGAL THEORY ON WHICH THE CLAIM IS BASED, AND EVEN IF CANON USA HAS BEEN ADVISED OF THE POSSIBILITY OF SUCH DAMAGES. NOR SHALL RECOVERY OF ANY KIND AGAINST CANON USA BE GREATER THAN THE PURCHASE PRICE OF THE EQUIPMENT SOLD BY CANON USA AND CAUSING THE ALLEGED DAMAGE. WITHOUT LIMITING THE FOREGOING, YOU ASSUME ALL RISK AND LIABILITY FOR LOSS, DAMAGE OR INJURY TO YOU AND YOUR PROPERTY AND TO OTHERS AND THEIR PROPERTY ARISING OUT OF USE, MISUSE OR INABILITY TO USE THE EQUIPMENT NOT CAUSED DIRECTLY BY THE NEGLIGENCE OF CANON USA (SOME STATES DO NOT ALLOW THE EXCLUSION OR LIMITATION OF INCIDENTAL OR CONSEQUENTIAL DAMAGES, SO THE ABOVE LIMITATION MAY NOT APPLY TO YOU). THIS WARRANTY SHALL NOT EXTEND TO ANYONE OTHER THAN THE ORIGINAL PURCHASER OF THIS EQUIPMENT OR THE PERSON FOR WHOM IT WAS PURCHASED AS A GIFT.

This warranty gives you specific legal rights, and you may also have other rights which vary from state to state.

CANON PROFESSIONAL DIGITAL VIDEO EQUIPMENT LIMITED WARRANTY FOR PRODUCTS PURCHASED IN CANADA

The limited warranty set forth below is given by Canon Canada Inc. ('Canon Canada') with respect to Canon Professional Digital Video Equipment (the 'Equipment') packaged with this limited warranty and purchased in Canada. This limited warranty is only effective upon presentation of your Bill of Sale or other proof of purchase. The Equipment is warranted to the original end-user purchaser, when delivered in new condition in its original container, under normal use against defective materials or workmanship as follows:

Parts: Defective parts will be exchanged for new parts or comparable rebuilt parts for a period of ONE YEAR from the date of original purchase.

Labor: For a period of ONE YEAR from the date of original purchase, labor will be provided free of charge by Canon Canada's factory service center or designated service facilities located in Canada.

When returning Equipment under this warranty, you must pre-pay the shipping charges, and you must enclose a copy of the Bill of Sale or other proof of purchase with a complete explanation of the problem. During the ONE-YEAR warranty period, repairs will be made and the Equipment will be return-shipped to you free of charge. For repairs after the warranty period is over, you will be given an estimate of the cost of repair and an opportunity to approve or disapprove of the repair expense before it is incurred. If you approve, repairs will be made and the Equipment will be returned to you at your risk and expense. If you disapprove, we will return-ship the Equipment to you at no charge to you to an address within Canada.

This limited warranty only applies if the Equipment is used in conjunction with compatible computer equipment and compatible software, as to which items Canon Canada will have no responsibility. Canon Canada shall have no responsibility under this limited warranty for use of the Equipment in conjunction with incompatible peripheral equipment and/or incompatible software. Non-Canon brand peripheral equipment and software which may be distributed with, or factory loaded on, the Equipment, are sold 'AS IS' without warranty of any kind by Canon Canada, including any implied warranty or condition regarding merchantability or fitness for a particular purpose. The sole warranty with respect to such non-Canon brand items is given by the manufacturer or producer thereof. If the Equipment contains a hard disk drive, Canon Canada recommends that data stored on that drive be duplicated or backed up to prevent its loss in the event of failure or other malfunction of such drive.

In order to obtain warranty service, please contact the authorized Canon retail dealer from whom you purchased the Equipment or contact the CANON PROFESSIONAL SERVICE CENTRE 1-800-667-2666 or on the Internet at www.canon.ca/pro. You will be directed to the nearest service facility for your Equipment.

This Limited Warranty covers all defects encountered in normal use of the Equipment and does not apply in the following cases:

- A. Loss or damage to the Equipment due to abuse, mishandling, accident, improper maintenance, use of non-Canon accessories or failure to follow operating, maintenance or environmental instructions prescribed in Canon Canada's user's manual;
- B. If the Equipment is defective as a result of leaking batteries, sand, dirt or water damage;
- C. If defects or damages are caused by the use of parts or supplies (other than those sold by Canon Canada) that cause damage to the Equipment or that cause abnormally frequent service calls or service problems;
- D. If defects or damages are caused by service other than Canon Canada's factory service centers or authorized service facilities;
- E. Any internal modification to product hardware or firmware;
- F. Any applicable fee for Maintenance of the Equipment;
- G. If the Equipment has had its serial number or dating altered or removed.

This Limited Warranty does not apply to Equipment purchased outside Canada. This Limited Warranty does not apply to accessories or consumables for the Equipment, which are sold "AS IS", without warranty of any kind by Canon Canada. Please retain this warranty card and your Bill of Sale as a permanent record of your purchase. This card ensures that you are contacted promptly should there be a safety inspection, modification or product recall under applicable laws or regulations.

NO IMPLIED WARRANTY OR CONDITION, INCLUDING MERCHANTABILITY AND FITNESS FOR A PARTICULAR PURPOSE APPLIES TO THIS EQUIPMENT AFTER THE APPLICABLE PERIOD OF EXPRESS WARRANTY OR GUARANTY (EXCEPT AS MENTIONED ABOVE) GIVEN BY ANY PERSON, FIRM OR CORPORATION WITH RESPECT TO THIS EQUIPMENT SHALL BIND THE UNDERSIGNED (SOME PROVINCES DO NOT ALLOW LIMITATIONS ON HOW LONG AN IMPLIED WARRANTY OR CONDITION LASTS, SO THE ABOVE LIMITATION OR EXCLUSION MAY NOT APPLY TO YOU). CANON CANADA SHALL NOT BE LIABLE FOR LOSS OF REVENUES OR PROFITS, EXPENSE FOR SUBSTITUTE EQUIPMENT OR SERVICE, STORAGE CHARGES, LOSS OR CORRUPTION OF DATA, INCLUDING WITHOUT LIMITATION, LOSS OR CORRUPTION OF DATA STORED ON THE EQUIPMENT'S HARD DRIVE, OR ANY OTHER SPECIAL, INCIDENTAL OR CONSEQUENTIAL DAMAGES CAUSED BY THE USE, MISUSE OR INABILITY TO USE THE EQUIPMENT, REGARDLESS OF THE LEGAL THEORY ON WHICH THE CLAIM IS BASED, AND EVEN IF CANON CANADA HAS BEEN ADVISED OF THE POSSIBILITY OF SUCH DAMAGES. NOR SHALL RECOVERY OF ANY KIND AGAINST CANON CANADA BE GREATER THAN THE PURCHASE PRICE OF THE EQUIPMENT SOLD BY CANON CANADA AND CAUSING THE ALLEGED DAMAGE. WITHOUT LIMITING THE FOREGOING, YOU ASSUME ALL RISK AND LIABILITY FOR LOSS, DAMAGE OR INJURY TO YOU AND YOUR PROPERTY AND TO OTHERS AND THEIR PROPERTY ARISING OUT OF USE, MISUSE OR INABILITY TO USE THE EQUIPMENT NOT CAUSED DIRECTLY BY THE NEGLIGENCE OF CANON CANADA (SOME PROVINCES DO NOT ALLOW THE EXCLUSION OR LIMITATION OF INCIDENTAL OR CONSEQUENTIAL DAMAGES, SO THE ABOVE LIMITATION MAY NOT APPLY TO YOU). THIS WARRANTY SHALL NOT EXTEND TO ANYONE OTHER THAN THE ORIGINAL PURCHASER OF THIS EQUIPMENT OR THE PERSON FOR WHOM IT WAS PURCHASED AS A GIFT.

This warranty gives you specific legal rights, and you may also have other rights which vary from province to province.



Canon Inc. 30-2, Shimomaruko 3-chome, Ohta-ku, Tokyo 146-8501, Japan
Canon Europa N.V. Bovenkerkerweg 59, 1185 XB Amstelveen, The Netherlands <http://www.canon-europe.com>

The information in this document is verified as of January 2024. Subject to change without notice.
Visit your local Canon website to download the latest version.