



MV7

Podcast Microphone

The Shure MV7 USB cardioid microphone user guide. Includes specifications and how to set up, update, and troubleshoot the mic.
Version: 4.3 (2024-D)

Table of Contents

MV7 Podcast Microphone	3	Control your Levels	11
General Description	3	Use Lock Mode to Lock In Your Sound	11
Features	3	Monitor Your Sound	11
Connect Your MV7	3	Three Ways to Use Your MV7 Podcast Microphone	11
Quick Setup	4	How to Avoid Plosives When Recording	11
Touch Panel Interface	4	Using the MV7 for Video Calls	11
Controls	5	How to Set Up the MV7 as an Aggregate Device in an iOS DAW	11
LED Behavior	5	Troubleshooting	11
The MV7 Microphone	5	Firmware Update	12
MV7 Outputs	5	Keep equipment connected during updates	12
Mounting Instructions	6	System Requirements	13
Windscreen	6	System Requirements and Compatibility: Mac	13
Auto Level Mode	6	System Requirements and Compatibility: Windows	13
Near	7	System Requirements and Compatibility: iOS	13
Far	7	System Requirements and Compatibility: Android	13
Additional Tips	7	Additional Resources	13
The Shure MOTIV Desktop App	8	Specifications	13
Mic Setup: Auto Level	8	MV7 Yoke Assembly	16
Mic Setup: Manual	9	Accessories	17
Monitor Mix Blend	10	Furnished Accessories	18
EQ Modes	10	Replacement Parts	18
Advanced Mic Settings	11	Optional Accessories	18
MV7 Tips	11	Certifications	18
		Information to the user	18

MV7

Podcast Microphone

General Description

The Shure MV7 is a professional-quality USB dynamic microphone, ideal for close mic applications that require vocal intelligibility with a balanced tone. The attractive and durable all-metal design features an adjustable yoke that can be mounted onto a variety of microphone stands for flexible placement options. A touch panel user interface provides control of microphone gain, headphone level, monitor mix blend and muting.

Features

Convenient Plug-and-Play Operation

Compatible with Windows and Mac computers. Also compatible with iOS and Android devices with applicable cables. (Cables not provided.)

Note: See <https://www.shure.com/en-US/motiv-compatibility> for information on recommended Android devices.

Voice Isolation Technology

Highly directional cardioid pattern isolates your voice and removes unwanted background noise

Durable, Versatile Design

- Hybrid USB/cardioid microphone can be used for digital or analog recording
- Adjust settings with the intuitive touch panel interface
- Rugged, all-metal construction and excellent cartridge protection for outstanding reliability

Flexible Sound Control with the ShurePlus MOTIV™ Desktop Application

The MOTIV Desktop Application offers control over microphone settings and includes the following additional features:

- **Auto Level Mode** Automatically adjusts microphone settings to take the guesswork out of gain and compression settings
- **Custom user presets**
- **Switchable EQ filters** High-pass filter and voice boost emphasis (presence boost) options in Manual mode

Connect Your MV7

1. Plug the included Micro-B USB cable into your MV7.
2. Connect the other end of the Micro-B USB cable to your laptop.
3. Plug your headphones into the monitor output.

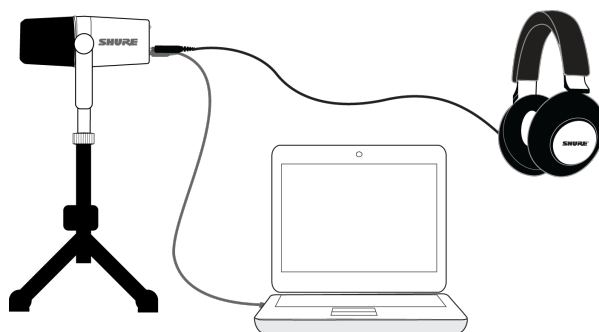

Quick Setup

1. **Use the correct cable to plug the microphone into your computer.**

The LEDs on the MV7 will pulse when the connection is made.

2. **Download the app at <https://www.shure.com/MOTIVdesktop>.**

Your computer may request permission to use the external device the first time the app is opened.

3. **Select your microphone from the drop down menu.**

Access customized controls for your MOTIV microphone.

4. **Check audio levels and adjust microphone settings.**

Manually adjust microphone gain or select Auto Level Mode for worry free audio setup. See the "Advanced Mic Settings" topic for information on advanced features.

Touch Panel Interface

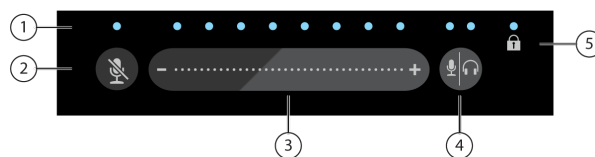

Touch Panel

- ① **LED bar** Displays microphone and headphone level. The LED color indicates which level is being displayed or adjusted.

- **Green:** Microphone level
- **Orange:** Headphone level
- **Green/Orange:** Monitor Mix blend level

- ② **Mute Button** Press to mute and unmute the microphone.

- ③ **Volume Control Slider** Adjust microphone or headphone level by swiping your finger several times up and down the control surface.

④ **Monitor Toggle** Press the mode/headphone button to toggle between microphone (green) and headphone (orange) volume controls. Long press to activate monitor mix controls (both green and orange). Another long press to return to separate microphone and headphone volume controls.

⑤ **Lock Indicator** Displays whether the settings lock is on or off. Settings lock prevents changes to microphone settings from accidental touches. When Lock mode is on, the microphone settings screen is grayed out on the desktop application.

Controls

Adjust monitor mix: Press and hold Monitor Toggle for 2 seconds to access monitor mix controls. Swipe left to hear more mic audio (green) or swipe right to hear more playback audio (orange). Press and hold Monitor Toggle to return to separate microphone and headphone volume controls.

Settings lock: Press and hold both Mute and Monitor Toggle for 2 seconds to lock and unlock settings.

Exit Auto Level Mode: Press and hold Mute for 2 seconds

Note: Auto Level Mode can only be enabled through the MOTIV Desktop Application.

LED Behavior

Live meters: Turn your Touch Panel LEDs into a visual volume meter for easy monitoring. If are using Manual mode and notice the level reaches the input meter peak, switch to Auto Level or lower the mic gain.

Night mode: Select the Night mode to lower the brightness of the Touch Panel LEDs from a bright display (Normal) to less bright (Dim). The Night mode display option is ideal for discreet recording in low-light situations.

Access the Live meters and Night mode toggles by going to Settings > LED Behavior in the MOTIV app settings tab.

Note: For information on dB values related to the Touch Panel slider, see the Touch Panel Values table in the Specifications appendix.

The MV7 Microphone

The MV7 features a dynamic capsule with a cardioid pattern, which uses Voice Isolation Technology to pick up sound directly in front of the microphone.

MV7 Outputs

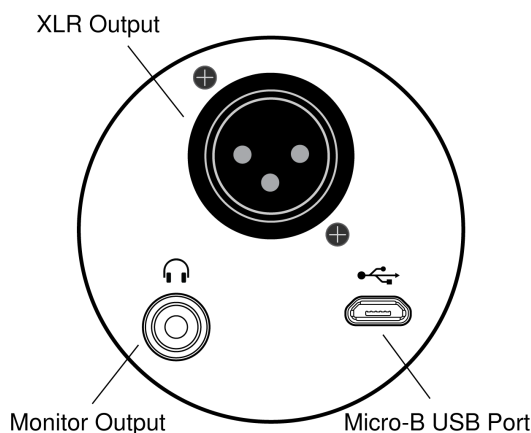

- **Passive XLR output:** Connect to XLR mixers and interfaces.

Note: XLR audio is not affected by software settings.

- **3.5mm monitor output:** Connect to headphones and earphones
- **Micro-B USB:** Use the included USB-A and USB-C cable to connect to your computer

Mounting Instructions

The MV7 microphone comes equipped with a 5/8"-27 threaded mount, the thread size most commonly found on microphone stands. This mount can be used with a microphone stand or hung from a boom. Some stands may require an adapter, which is not provided.

Note: Be very careful not to unloosen the screws all the way.

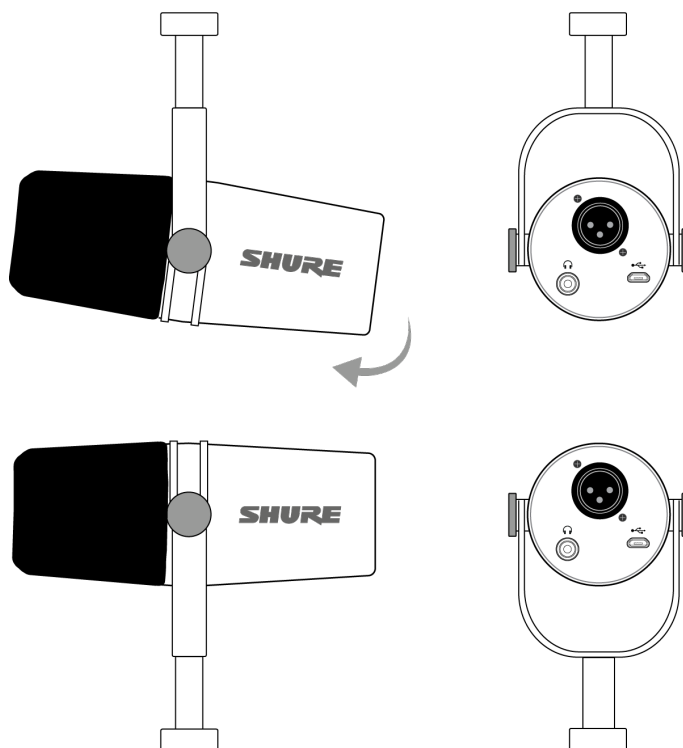

To easily flip the microphone orientation, loosen the screws and rotate 180 degrees.

Windscreen

The windscreen offers maximum protection from plosives and creates a warmer, more intimate sound for speech applications, like podcasting and gaming.

Auto Level Mode

Use the following suggestions as a great starting point for your most common MV7 needs. Keep in mind that there are many effective ways to mic a voice. The closer you can get to the microphone, the better, but Auto Level Mode really helps to get you sounding your best. Experiment to find which mic placement works best for you.

Near

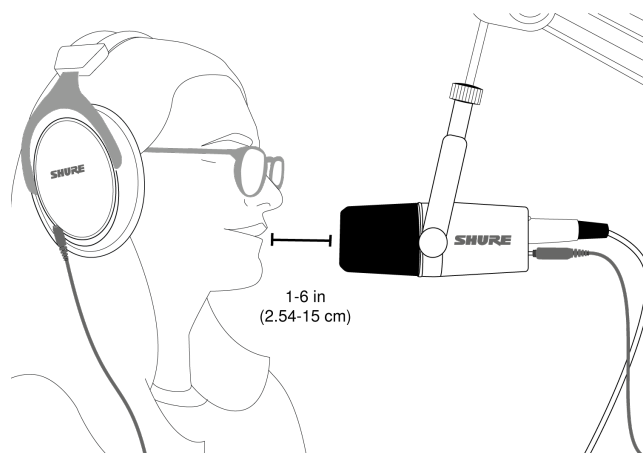

For podcast and voice recording applications. Position the MV7 in front of and as close to your face as possible. Speak directly into the mic, 1-6 inches (2.54 - 15 cm) away for a more intimate voice sound with maximum rejection of off-axis sounds. Speaking closer to the microphone results in more bass response, similar to voices on a radio broadcast. Make additional gain adjustments if necessary.

Far

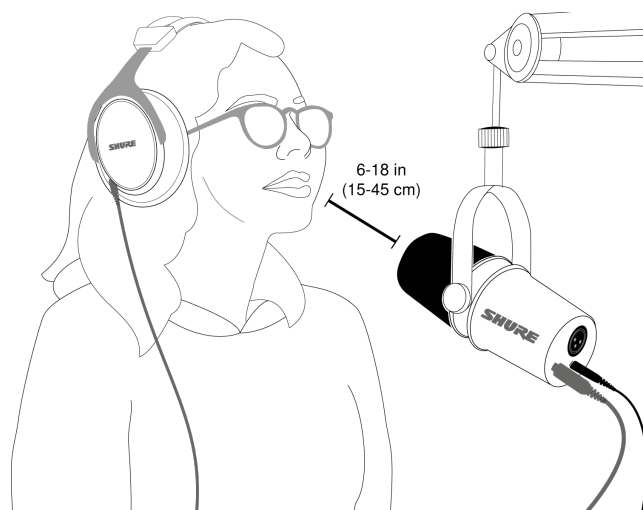

Ideal when the sound source is further from the microphone, like in gaming when the person needs to be closer to the screen or gaming console. Aim the microphone directly at the sound source. Place the microphone 6 to 18 inches (15 to 45 cm) away from the sound source. Make additional gain adjustments if necessary.

Tip: Because the MV7 is highly directional, ensure that the microphone is directly pointed towards the source. If possible, experiment with mic placement to find where it sounds best. Make additional gain adjustments as necessary.

Additional Tips

Shure offers educational articles and publications on recording techniques for a variety of instruments and applications. Visit [Shure Educational Articles](#) for more information.

The Shure MOTIV Desktop App

Use the Shure MOTIV desktop app to quickly adjust microphone settings. The device stores the most recently used settings for quick setup.

Mic Setup: Auto Level

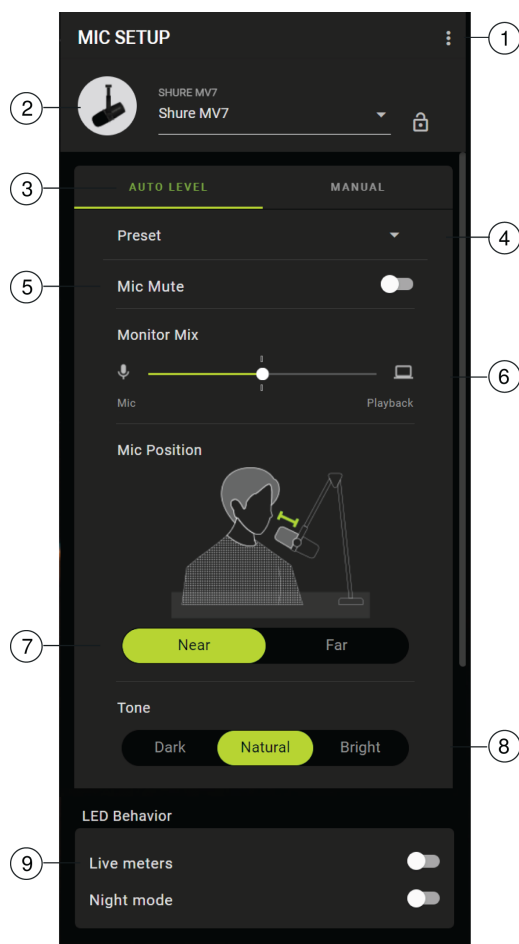

① **Settings** Click the three dots to access MOTIV software information, manage presets, application preferences and check for firmware updates.

② **Mic Selection/Settings Lock** Tap the caret to access settings for your microphone. Tap the lock to lock and unlock selected settings.

③ **Auto Level Mode / Manual Mode** AUTO LEVEL mode allows the app to select best choices for your recording needs. Or select MANUAL mode for full control over the microphone settings.

④ **Custom Presets** Use the drop-down to create your own custom presets.

⑤ **Mic Mute** Use the toggle to mute and unmute your microphone.

⑥ **Monitor Mix slider** Move the slider to adjust the levels of mic and playback sound sources. See "Monitor Mix Blend" for more information on monitoring.

⑦ **Mic Position** Select the distance, Near or Far, from the sound source to the microphone.

⑧ **Tone** Adjust the tonal qualities of your audio by selecting Dark, Natural or Bright tone. Tone controls a variety of settings to quickly dial in the sound that works best for your voice.

⑨ **LED Behavior** Turn on Live meters to use your Touch Panel for mic gain metering. Use Night mode to lower the brightness of your Touch Panel. See "LED Behavior" for more information on using these features for metering and dimming.

Mic Setup: Manual

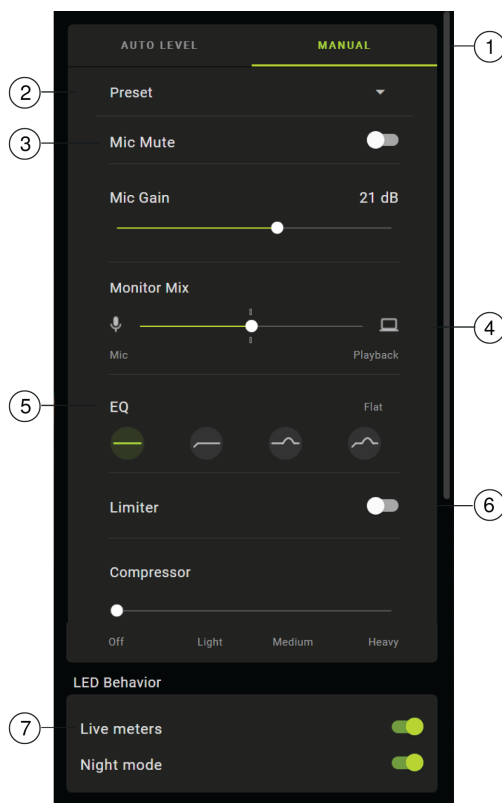

① **Auto Level Mode / Manual Mode** AUTO LEVEL mode allows the app to select best choices for your recording needs. Or select MANUAL mode for full control over the microphone settings.

② **Custom Presets** Use the drop-down to create your own custom presets.

③ **Mic Mute / Mic Gain** Use the toggle to mute and unmute your microphone. Use the slider to control microphone gain.

Note: Some programs can control microphone gain while in Manual mode. We recommend locking your mic settings once you have it set the way you'd like.

④ **Monitor Mix slider** Move the slider to adjust the levels of mic and playback sound sources. See "Monitor Mix Blend" for more information on monitoring.

⑤ **EQ** Use the equalizer to add a high-pass filter, presence or both. Tap Flat to return to an unchanged equalization state.

⑥ **Limiter and Compressor settings** Fine tune your audio with limiter and compressor controls. See "Advanced Mic Settings" for more information.

⑦ **LED Behavior** Turn on Live meters to use your Touch Panel for mic gain metering. Use Night mode to lower the brightness of your Touch Panel. See "LED Behavior" for more information on using these features for metering and dimming.

Note: Be aware that manual settings will be reset if you switch to Auto Level mode and switch back to manual mode.

Monitor Mix Blend

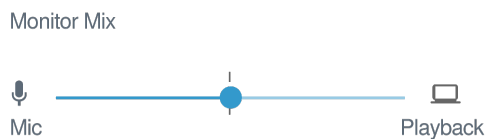

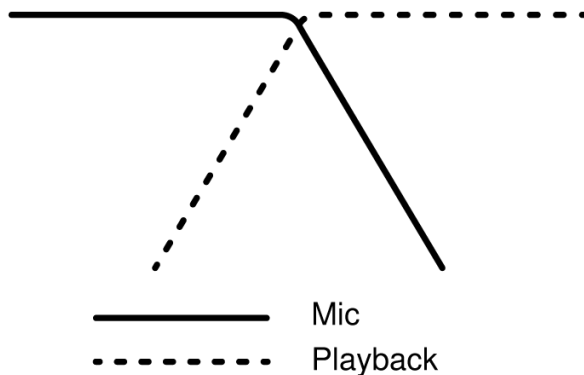

Use the monitor mix slider to adjust how much of each source you can hear. For best results, start monitoring at the midpoint and adjust.

- Move the slider towards the microphone icon (Mic) to hear more of the audio going into the mic. Like when you're singing over a recorded guitar track and want to clearly hear your voice.
- Move the slider towards the device icon (Playback) to hear more of the track playing back. When you're recording a harmony to your original vocal track and want to clearly hear the original performance.



EQ Modes

Use the equalizer to boost or cut bands of frequencies to improve sound clarity. Tap Flat to return to an unchanged equalisation state.

Mode	Characteristics
 Flat	A completely unprocessed signal (no equalization settings used).
 High-pass	High-pass filter to reduce proximity effect.
 Presence boost	Equalization that emphasizes clarity and fullness.

Mode	Characteristics
 <p data-bbox="152 296 261 428">High-pass presence boost</p>	<p data-bbox="287 310 1234 338">Combination high-pass filter and presence boost to improve definition and focus on clarity</p>

Advanced Mic Settings

Fine-tune your sound with limiter, compression, and equalizer settings.

Limiter

Toggle the limiter on or off to prevent distortion from volume peaks in your recording.

Compressor

Choose no compression, or select light, medium or heavy compression to control volume when your sound source is dynamic. Quiet signals are boosted and loud signals are lowered, resulting in a denser, louder sound.

MV7 Tips

Control your Levels

To ensure consistent volume levels, determine the microphone placement that works best for you and maintain that distance. Record several practice tests to determine the spot where your voice sounds best and background sounds are minimized.

Use Lock Mode to Lock In Your Sound

When you've tested your audio and have found the settings that sound great, press and hold both Mute and Monitor Toggle for 2 seconds to lock and prevent accidental adjustment and ensure that your audio remains consistent.

Monitor Your Sound

To hear your audio, plug headphones into the headphone output on your MOTIV device.

Three Ways to Use Your MV7 Podcast Microphone

How to Avoid Plosives When Recording

Using the MV7 for Video Calls

How to Set Up the MV7 as an Aggregate Device in an iOS DAW

Troubleshooting

Issue	Solution
Microphone is plugged in, but not detected.	Unplug and reconnect the cable so that the app recognizes the microphone. You'll know that the connection is made when you see the desktop application display the correct microphone settings.
You hear no audio even though the desktop application is displaying the correct microphone.	Check the Monitor Mix blend. Move the Monitor Mix slider to the center to hear the audio going into the mic and the audio being played back at the same time.
Audio is distorted (Auto Level Mode)	Select Auto Level Mode to allow the software to control audio settings. Near for up-close applications (1-6 in. / 2.54-15 cm) and Far for a distance of 6-18 inches. (15-45 cm)
Audio is distorted (Manual Mode)	Audio distortion usually comes from overloading the microphone which causes clipping. Lower your mic gain for the best sound recording.
Headphone LED flashes. Audio sounds higher or lower pitch than normal.	Your microphone and computer have a sample rate mismatch. To adjust your computer sample rate settings, go to the Shure FAQ topic for information on correcting sample rate mismatch . Note: Windows update 10 v2004 (April 2020) solves this problem.
Microphone has become detached from the yoke.	See the MV7 Yoke Assembly topic for step by step instructions for re-assembling your yoke and assorted washers. Correct washer assembly is crucial to ensure that your microphone is securely in place.
Miscellaneous issues	It may be useful to reset the app to restore functionality. Perform a hard reset by unplugging and re-plugging the microphone.
General troubleshooting	Quit and re-start the app. Reboot the computer. Check for firmware update. Tap the three dots in the top right corner and select About MOTIV > Check for Update

Note: Contact Shure Service and Repair if you continue to experience any issues.

Firmware Update

Take advantage of additional features and design enhancements by updating the firmware when prompted. A notification will appear when a firmware update is available. You have the option to download the update immediately or at a later time.

To access firmware update at a later time, tap the three dots > About > Check for Update. Tap the caret icon and if the available firmware package is newer than the current version, tap Send to device. Contact Shure Service and Repair if you experience any issues.

Keep equipment connected during updates

Keep the MOTIV device connected to your mobile device when updating to ensure that there are no update issues.

System Requirements

System Requirements and Compatibility: Mac

- MacOS 10.13 to 10.15
- 64 bit
- Minimum 2 GB of RAM
- Minimum 500 MB of hard disk space

System Requirements and Compatibility: Windows

- Windows 10
- 64-bit
- Minimum 2 GB of RAM
- Minimum 500 MB of hard disk space

System Requirements and Compatibility: iOS

- **iOS:** iOS 15 and higher
- **iPhone:** iPhone 12 and higher
- **iPad:** iPad Pro (USB-C)

System Requirements and Compatibility: Android

Will work with any Android device that has:

- Android 12.0 (Snow Cone) and higher
- USB Audio Class 2.0 support and higher
- Bluetooth 5.0 and higher

Android is a trademark of Google Inc.

Note: See <https://www.shure.com/en-US/motiv-compatibility> for information on supportive Android devices.

Additional Resources

- [Shure Knowledge Base FAQs](#)
- [Training from the Shure Audio Institute](#)
- [Microphone Techniques for Recording](#)
- [Houses of Worship Systems Guide](#)
- [Shure Performance & Production YouTube channel](#)
- [Shure Creators YouTube channel](#)

Download Shure Software

- [Software and firmware archive](#)
-

Specifications

MFi Certified

Yes

DSP Modes (Presets)

Near/Far, Dark/Natural/Bright

Transducer Type

Dynamic (moving coil)

Polar Pattern

Unidirectional (Cardioid)

Output Impedance

314 Ω

Frequency Response

50 Hz to 16,000 Hz

Adjustable Gain Range

0 to +36 dB

Sensitivity

(@ 1 kHz, open circuit voltage)

-55 dBV/Pa [1] (1.78 mV), -47 dBFS/Pa [1] [2]

Maximum SPL, Digital Output

132 dB SPL [2]

Headphone Output

3.5 mm (1/8")

Polarity

Positive pressure on diaphragm produces positive voltage on pin 2 with respect to pin 3

Mute Switch Attenuation

Yes

Limiter

Yes

Compressor

Yes

Power Requirements

Powered through USB or Lightning connector

Phantom Power Protection

Yes

Housing

All metal construction

Mounting Type

5/8-27 thread mount

Net Weight

0.55 kg (1.21 lbs)

[1] 1 Pa=94 dB SPL

[2] At Minimum Gain, Flat Mode

Bit Depth	Sampling Rate
24	48 kHz
24	44.1 kHz
16	48 kHz
16	44.1 kHz

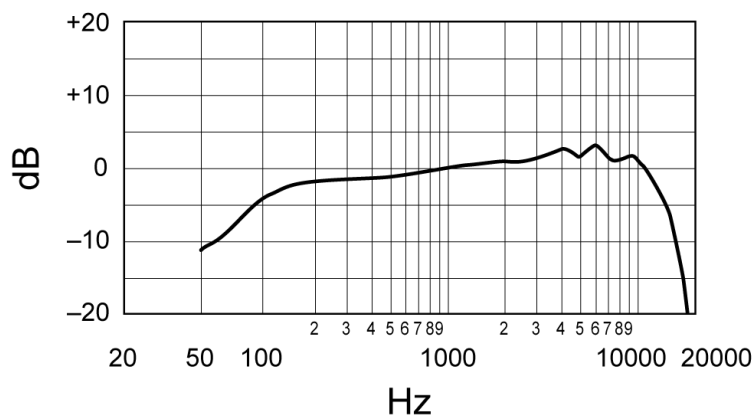

Typical Frequency Response

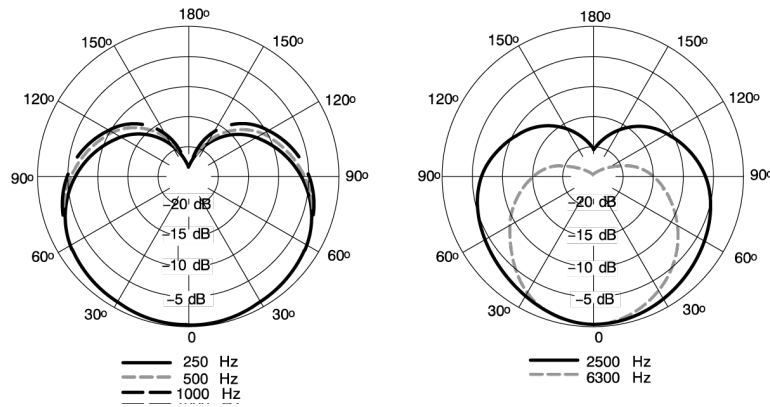

Typical Polar Pattern

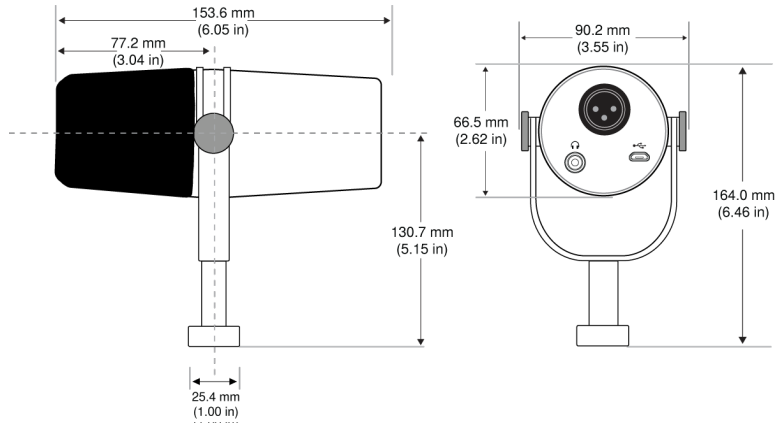

Overall Dimensions

Slider LED	Color	dB Value
8	Yellow	-6 dB
7	Yellow	-12 dB
6	Yellow	-18 dB
5	Green	-24 dB
4	Green	-30 dB
3	Green	-39 dB
2	Green	-48 dB
1	Green	-90 dB

MV7 Yoke Assembly

The MV7 yoke allows a podcaster to be flexible with mic placement. Loosen the yoke knobs and you can adjust the microphone in a variety of angles. If the microphone becomes detached from the yoke, these are the steps to put it together in the cor-

rect order to ensure that your microphone is secure. Each side uses one thin gray spring washer, one shiny silver brass washer, two black plastic washers and the yoke and threaded yoke knob.

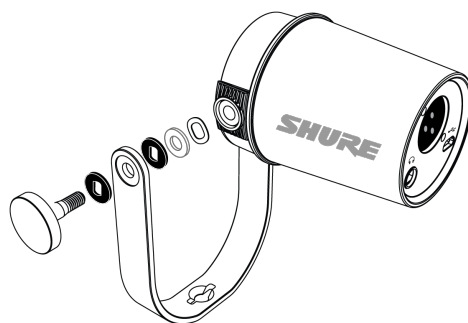

1. **Start with the threaded knob flat side down on your tabletop.**



2. **Stack the washers on the threaded knob.**
 - Place a black plastic washer on the knob.
 - Place one side of the yoke on next.
 - Then put the second black plastic washer on.
 - Place the flat silver washer and then the thin spring washer on the threaded knob.
3. **Using your finger to hold the screw assembly in place, slide the MV7 onto the threaded screw and turn the knob to keep washers in place.**

Note: Be sure to keep this side on but loose so that you have room to easily move the yoke and assemble the washers on the opposite side.

4. **On the opposite yoke arm, place the washers into the side of the MV7 in reverse order.** Thin spring washer > Flat silver washer > Black plastic washer > Yoke arm
5. **The yoke arm needs to be placed directly onto the stack of washers. To ensure that the washers are aligned, put a pen through the yoke and washers to make sure that everything is properly centered. Leave pen in place.**
6. **Place the second black plastic washer onto the remaining threaded knob.**
7. **Remove the pen. Insert the threaded knob and black plastic washer into the stacked washers and tighten both sides to ensure that your microphone is stable.**

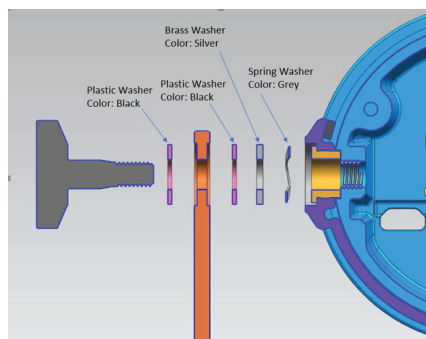

Accessories

Furnished Accessories

10 foot Micro-B to USB-A cable	95A45110
10 foot Micro-B to USB-C cable	95B38076

Replacement Parts

Black Windscreen	AMV7-K-WS
Silver Windscreen	AMV7-S-WS

Optional Accessories

1 m Lightning cable	AMV-LTG
---------------------	---------

Certifications

Information to the user

This equipment has been tested and found to comply with the limits for a Class B digital device, pursuant to part 15 of the FCC Rules. This equipment generates, uses, and can radiate radio frequency energy and, if not installed and used in accordance with the manufacturer's instruction manual, may cause interference with radio and television reception.

Notice: The FCC regulations provide that changes or modifications not expressly approved by Shure Incorporated could void your authority to operate this equipment.

These limits are designed to provide reasonable protection against harmful interference in a residential installation. This equipment generates, uses, and can radiate radio frequency energy and, if not installed and used in accordance with the instructions, may cause harmful interference to radio communications. However, there is no guarantee that interference will not occur in a particular installation. If this equipment does cause harmful interference to radio or television reception, which can be determined by turning the equipment off and on, the user is encouraged to try to correct the interference by one or more of the following measures:

- Reorient or relocate the receiving antenna.
- Increase the separation between the equipment and the receiver.
- Connect the equipment to an outlet on a circuit different from that to which the receiver is connected.
- Consult the dealer or an experienced radio/TV technician for help.

This device complies with part 15 of the FCC Rules. Operation is subject to the following two conditions:

1. This device may not cause harmful interference.
2. This device must accept any interference received, including interference that may cause undesired operation.

CE Notice

Hereby, Shure Incorporated declares that this product with CE Marking has been determined to be in compliance with European Union requirements.

The full text of the EU declaration of conformity is available at the following site: <https://www.shure.com/en-EU/support/declarations-of-conformity>.

UKCA Notice

Hereby, Shure Incorporated declares that this product with UKCA Marking has been determined to be in compliance with UK-CA requirements.

The full text of the UK declaration of conformity is available at the following site: <https://www.shure.com/en-GB/support/declarations-of-conformity>.

This Class B digital apparatus complies with Canadian ICES-003. Cet appareil numérique de la classe B est conforme à la norme NMB-003 du Canada.

Industry Canada ICES-003 Compliance Label: CAN ICES-3 (B)/NMB-3(B)

This microphone for use with any microphone stand with a 5/8" threaded adapter.

Note: Testing is based on the use of supplied and recommended cable types. The use of other than shielded (screened) cable types may degrade EMC performance.

CE Notice

Hereby, Shure Incorporated declares that this product with CE Marking has been determined to be in compliance with European Union requirements.

The full text of the EU declaration of conformity is available at the following site: <https://www.shure.com/en-EU/support/declarations-of-conformity>.

This product meets the Essential Requirements of all relevant European directives and is eligible for CE marking.



Made for iPad (5th generation), iPad (6th generation), iPad (7th generation), iPad (8th generation), iPad Air 2, iPad Air 3, iPad Mini 4, iPad Mini 5, iPad Pro 9.7-inch (1st generation), iPad Pro (12.9-inch) 1st generation, iPad Pro 10.5-inch 2017 (2nd generation), iPad Pro 12.9-inch 2017 (2nd generation), iPhone 6s, iPhone 6s Plus, iPhone SE, iPhone 7, iPhone 7 Plus, iPhone 8, iPhone 8 Plus, iPhone X, iPhone Xs, iPhone Xs Max, iPhone XR, iPhone 11, iPhone 11 Pro, iPhone 11 Pro Max, iPhone 12, iPhone 12 Mini, iPhone 12 Pro, iPhone 12 Pro Max, iPhone SE 2, iPod Touch (7th generation).

iPad, iPhone, iPod and iPod touch are trademarks of Apple Inc., registered in the U.S. and other countries. iPad Air, iPad mini, and Lightning are trademarks of Apple Inc. The trademark "iPhone" is used in Japan with a license from Aiphone K.K.

Android Compatibility

This equipment is compatible with Android devices that support USB Audio Class 2.0 and USB-C connectivity. Not all Android devices are compatible. Android is a trademark of Google Inc.

