

# NUCLEUS-NII

**TILTA** WIRELESS LENS CONTROL SYSTEM



——— 原力NII无线跟焦系统 ———

# 目录/CONTENT

(CN) 免责声明 .....	01
注意事项和警告 .....	01
认识原力N II 控制手轮 .....	02
产品特点	
规格参数	
电池使用须知	
手轮的使用 .....	03
单独使用	
在其他设备上拓展	
认识手轮UI主界面 .....	04
认识原力N II 电机 .....	05
规格参数	
装配电机于镜头上	
电机供电说明 .....	06
电机线材连接方式	
电机指示灯灯语 .....	07
配对操作 .....	08
原力N II 控制手轮与原力N II 电机配对	
原力N II 控制手轮与原力M 电机配对(方法一)	
原力N II 控制手轮与原力M 电机配对(方法二)	
原力M 电机序号设置	
原力N II 控制手轮与VND专用电机配对	
固件更新 .....	09
手轮-固件更新	
电机-固件更新	
(EN) <b>DISCLAIMER</b> .....	12
<b>WARNING &amp; PRECAUTION</b> .....	12
<b>INTRODUCING NUCLEUS N II HAND UNIT</b> .....	13
FEATURES	
TECHNICAL DATA	
BATTERY USAGE GUIDELINE	
<b>USE THE HAND UNIT</b> .....	14
USE INDEPENDENTLY	
ATTACH TO OTHER ACCESSORIES	
<b>INTRODUCING THE MAIN UI</b> .....	15
<b>INTRODUCING NUCLEUS N II MOTOR</b> .....	16
TECHNICAL DATA	
ATTACHING MOTOR TO LENS	
<b>MOTOR POWERING GUIDELINE</b> .....	17
MOTOR CABLE CONNECTION METHOD	
<b>INDICATOR LIGHT</b> .....	18
<b>PAIRING</b> .....	19
THE NUCLEUS-N II HAND UNIT PAIRING WITH THE NUCLEUS-N II MOTOR	
THE NUCLEUS-N II HAND UNIT PAIRING WITH THE NUCLEUS-M MOTOR (METHOD1)	
THE NUCLEUS-N II HAND UNIT PAIRING WITH THE NUCLEUS-M MOTOR (METHOD 2)	
THE NUCLEUS-M MOTOR NUMBER SETTING	
THE NUCLEUS-N II HAND UNIT PAIRING WITH VND MOTOR	
<b>FIRMWARE UPDATE</b> .....	21
HAND WHEEL CONTROLLER - FIRMWARE UPDATE	
MOTOR - FIRMWARE UPDATE	



感谢您购买TILTA产品。

使用本产品之前,请仔细阅读本文以确保已对产品进行正确的设置。本文档及本产品所有相关的文档最终解释权归TILTA所有。如有更新,请访问[www.tilta.com](http://www.tilta.com)官方网站获取最新的产品信息。TILTA保留随时修改本手册中任何信息的权利,无需提前通知且不承担任何责任。

一旦使用本产品,即视为您已经仔细阅读免责声明与警告,理解、认可和接受本声明全部条款和内容。您承诺对使用本产品以及可能带来的后果负全部责任。您承诺仅出于正当目的使用本产品,并且同意本条款以及TILTA制定的任何相关条例、政策和指引。

TILTA对于直接或间接使用本产品而造成的损坏、伤害以及任何法律责任不予负责。用户应遵循包括但不限于本文提及的所有安全指引。

即使存在上述规定,消费者权益依然受当地法律法规所保障,并不受本免责声明影响。

TILTA是深圳市铁头科技有限公司及其关联公司的商标。本文出现的产品名称、品牌等均为其所属公司的商标或注册商标。

## 注意事项和警告

使用本产品前,请严格遵守以下说明,如因失误操作或者不正当使用等造成的相关后果,我司不负任何责任。

### 配件要求

- 充电环境温度高于 40 °C 或低于 5 °C 可能导致电池性能下降、膨胀、漏液、过热等损坏。
- 切勿将电池存储在超过60°C的环境下。理想的存储环境温度为 22 °C 至 28 °C。
- 电池必须使用TILTA官方提供的充电设备进行充电。对于使用非TILTA 官方提供的充电设备进行充电所造成的一切后果,TILTA将不予负责。

### 操作环境

- 本设备内含强磁,为避免产生磁化影响,请远离磁卡、IC卡、植入性医疗设备(如心脏起搏器)、硬盘、RAM 芯片等易受干扰设备。
- 请在温度为 -20 °C 至 45 °C 之间的环境中使用电池。温度过高将会引起电池异常膨胀、着火,甚至爆炸。在低温环境下使用之前,建议先在常温环境中将电池充满电量,以延长电池使用寿命。
- 请勿将设备放置在易燃、可燃物(如地毯和木制品)附近充电。请时刻留意充电过程,谨防发生意外。
- 请在干燥的环境下存储设备,理想的设备存放环境湿度不高于 40%。

### 电池安全

**⚠【警告】**本设备配有不可拆卸的内置电池,请勿自行更换电池,以免损坏电池或设备。

- 禁止在强静电或者磁场环境中使用电池,以免引起设备内部电路故障。
- 请勿将电池暴露在高温处或发热设备的周围,如日照、取暖器、微波炉、烤箱或热水器等。电池过热可能引起爆炸。
- 请勿拆解或改装电池、插入异物、或浸入水或其它液体中,以免引起电池漏液、过热、起火或爆炸。
- 电池内部电解液具有强腐蚀性,如果不小心接触到皮肤或眼睛,请立即用清水冲洗至少 15 分钟并马上就医。
- 请勿把电池扔到火里,否则会导致电池起火和爆炸。
- 请勿跌落、挤压或穿刺电池。避免让电池遭受外部的压力,从而导致电池内部短路和过热。
- 请勿使用已经损坏的电池。
- 切勿将电池彻底放完电后长时间存储,以避免电池进入过放状态而造成电芯损坏,将无法恢复使用。
- 务必将电池彻底放完电后,再将电池废置于指定的电池回收箱。电池是危险化学品,严禁弃置于普通垃圾箱。相关细节,请遵循当地电池回收和废置的法律法规。如电池无法彻底放电,请勿将电池直接弃置于电池回收箱,应联系专业电池回收公司做进一步的处理。

### 维护和保养

- 请保持设备清洁,无沙尘等异物。使用干净、干燥的布料及时清理产品上的异物。
- 请勿使设备及其配件受到强烈的冲击或震动,以免损坏设备及其配件,导致设备故障。
- 如果设备碰撞硬物或设备受到外界的强大冲击造成屏幕部分破碎,切勿触摸或试图移除破碎的部分,请立即停止使用并及时联系TILTA售后服务。

### 温馨提示

- 设备在工作状态中会产生轻微发热,此为正常现象。

## 02 认识原力N II 控制手轮

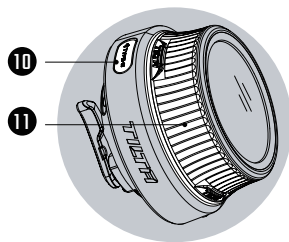
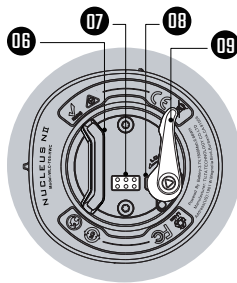
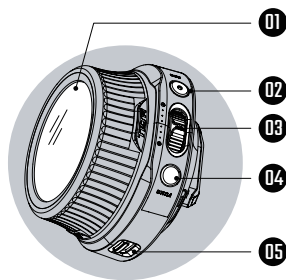

- 01** 1.6寸圆形触摸屏  
镜头及相机参数显示/调整
- 02** 【REC】键  
01 单击：REC录制启停功能  
02 长按3S：开/关机  
    长按8S：强制关机
- 03** 拨杆  
上下拨动，可控制一路电机
- 04** 【FUNC】功能键  
01 打标记  
02 行程校准
- 05** 限位开关  
切换TF/DF档（TF档：全面覆盖TILTA无线控制系统；DF档：兼容DJI稳定器跟焦电机控制）
- 06** NATO接口  
外接拓展设备
- 07** 电子触点  
01 通过供电手柄或多功能控制手柄给手轮供电  
02 与其他外接设备数据传输
- 08** 安全销  
具备NATO防脱功能
- 09** 扳扣  
锁紧NATO结构
- 10** Type-C接口  
充电
- 11** 手轮  
控制电机/调整参数



↑ 向上拨为打开TF档（手轮限定转动角度<360°）

↓ 向下拨切换为DF档（手轮旋转无角度限制）

### 产品特点



圆形触摸屏  
柔性交互设计/350ppi



TYPE-C  
支持PD快充



内置大容量电池/超长续航  
不间断工作超7小时/智能待机

### 规格参数

● 材质：铝合金+塑胶

● 尺寸：73\*72\*53mm

● 重量：175g

● 颜色配置：黑色

### 电池使用须知



手轮内置电池容量  
**3.7V 1800mAh 6.66Wh**

(1)工作温度：充电：0°C~45°C；放电：-10°C~60°C

(2)存储温度：-5°C~45°C

(3)运行湿度：45±20%(Max.)

(4)质保期：12个月且循环次数少于500次

## 03 手轮的使用

### 单独使用

通过操作手轮或拨杆控制电机。

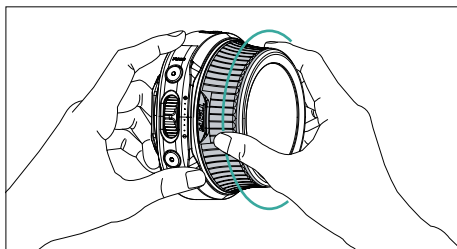

通过触摸屏可调整原力N II功能或控制部分相机参数。

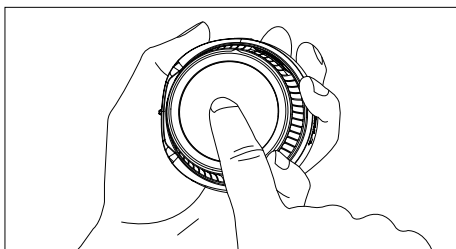

### 在其他设备上拓展

原力N II 控制手轮采用NATO规格快装接口,可装配在NATO拓展位上。  
(如带NATO结构的免笼或稳定器等设备上)

**注:** 装配和拆卸时,都需注意手轮背面的电子触点,防止外力损坏。

搭配原力N II 多功能控制手柄使用(如图)  
手轮可通过NATO结构装配在手柄上,锁紧扳扣完成装配。

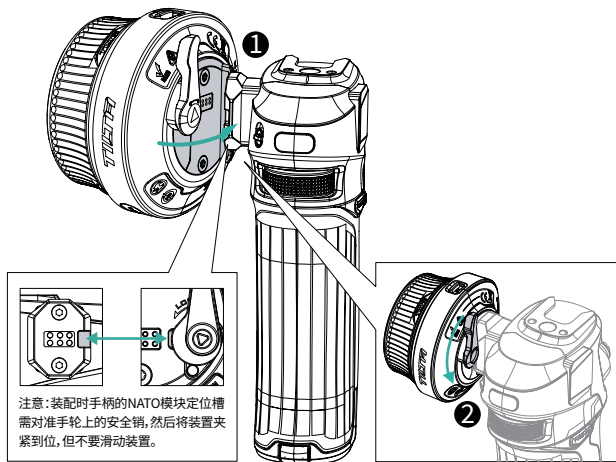

### 装配组合图

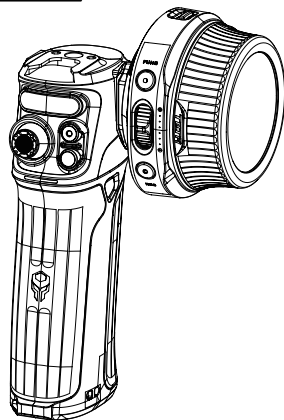

# 04 认识手轮UI主界面

原力N II控制手轮UI由三大主屏和四项设置菜单组成

三大主屏：相机控制界面、电机参数界面、焦距距离界面

四项设置菜单：连接设置、通用设置、系统设置、电机设置

开机后，手轮进入主界面左右滑动屏幕可切换三大主屏，自屏幕底部向上滑动可进入四项一级设置菜单，左右滑动选择需要的设置菜单并点按中心图标，进入二级设置界面。

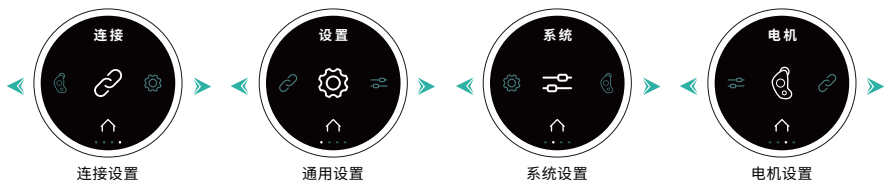

自下向上滑-进入菜单选项



相机控制界面-REC



相机控制界面-STBY

- 13 相机参数锁定按键
- 14 REC (录制)/STBY (待机) 标识
- 15 光圈参数信息
- 16 感光度参数信息
- 17 相机通讯协议信息
- 18 本次录制/待机时间
- 19 快门参数信息
- 20 色温参数信息
- 21 分辨率/码率/帧率

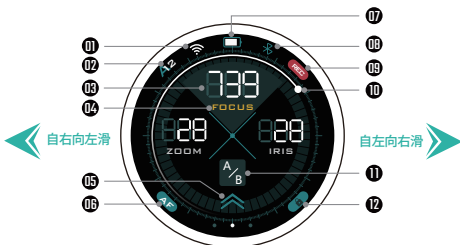

电机参数界面

- 01 WIFI状态
- 02 通讯频道  
(A:自动频道模式 M:手动频道模式 数字:频道序号)
- 03 电机参数(0-999)
- 04 电机指示  
(FOCUS电机指示 / ZOOM电机指示 / IRIS电机指示)
- 05 自下向上滑动进入菜单选项
- 06 AF/MF切换按键
- 07 电量信息
- 08 蓝牙状态
- 09 录制状态
- 10 手轮位置
- 11 打点按键 [标记点 (Mark) 起始/终止点 (Range)]
- 12 触摸屏锁定按键

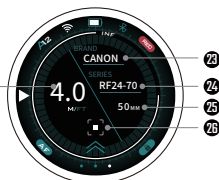

焦距距离界面

- 22 焦点位置
- 23 镜头品牌
- 24 镜头型号
- 25 焦段信息
- 26 打点按键

# 05 认识原力N II 电机

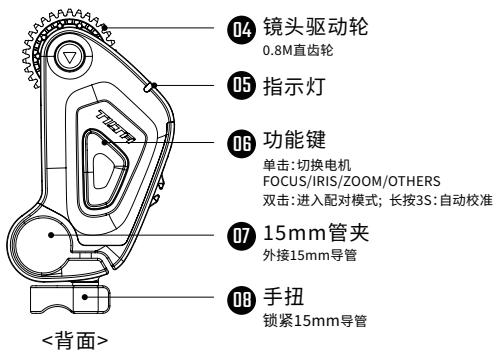
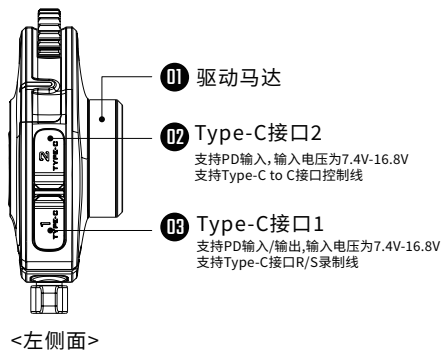

## 规格参数

- 材质: 铝合金+塑胶
- 尺寸: 83\*46\*31mm
- 重量: 80g
- 颜色配置: 黑色

## 装配电机于镜头上

### (1) 安装镜头跟焦环

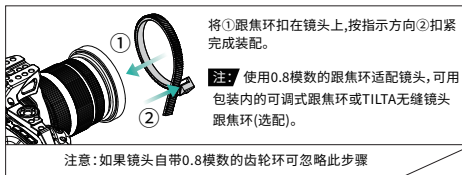

### (2) 安装双孔导管适配器和15mm导管

将③导管适配器安装在笼子侧臂的1/4螺纹孔上, 锁紧螺丝; 再将15mm导管④锁紧在导管适配器上, 便于装配电机。

### (3) 安装电机

将⑤电机安装在15mm导管上, 调整电机的角度后将M0.8齿轮搭在可调式跟焦环上, 锁紧导管手扭⑥即可完成装配。

可根据需求选配TILTA导管适配件来装配电机:

如TILTA的侧臂单孔导轨卡件(TA-SRA-15)/底部单孔卡件(TA-BSRA-15)/15mm标准底座(TA-BSP6-15-B)等, 如下图。

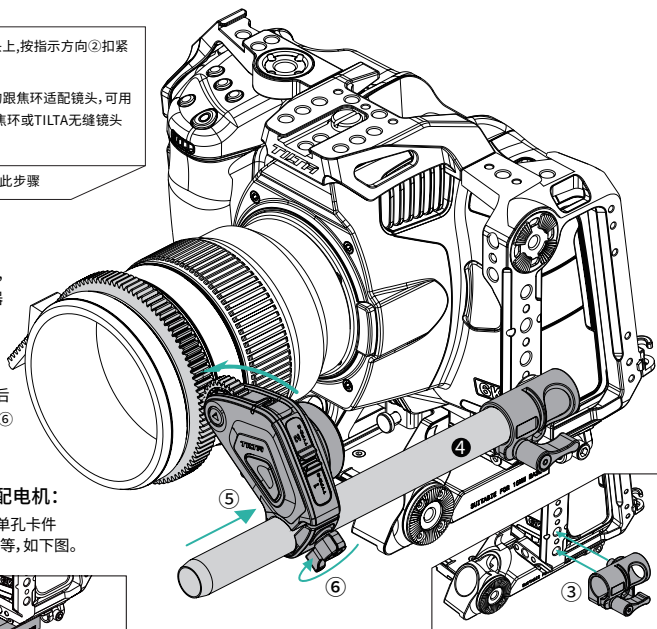
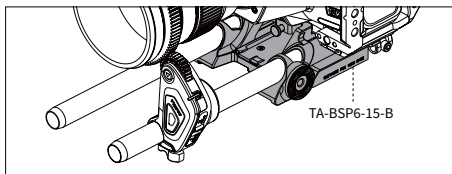

# 06 电机供电说明

可搭配TILTA的**移动电源支架**或**NP-F供电底板(选配)**来装配供电设备,再通过Type-C接口(PD协议)为跟焦电机供电。

## 安装移动电源支架 (TA-UPBH-B)

将移动电源支架安装到1/4螺纹孔上,拧紧螺丝后装配供电设备(如充电宝)。

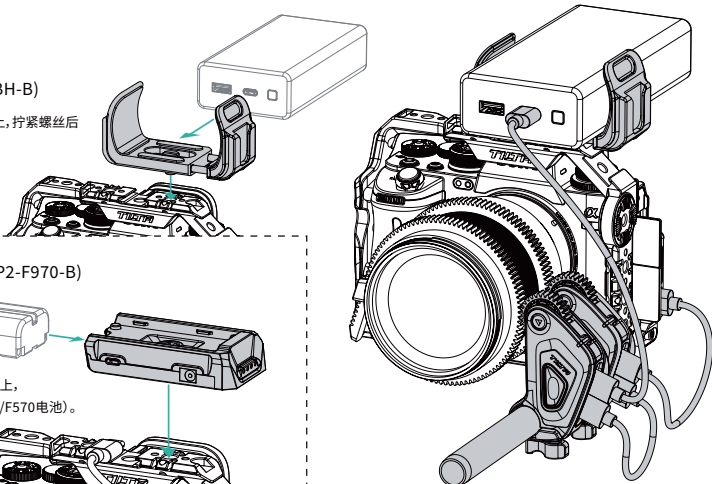

## 安装NP-F供电底板 (TA-BTP2-F970-B)

将NP-F供电底板安装到1/4螺纹孔上,拧紧螺丝后装配供电设备(如F550/F570电池)。

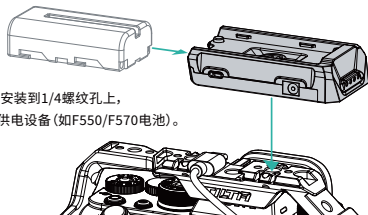

## 电机线材连接方式

**提示:** 多个电机同时使用时,可使用Type-C(PD协议)接口串连,同步供电。

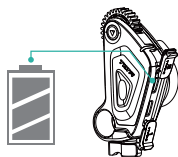

PD电源/V口电池+1个电机  
+PD供电线 (Type-C to C)

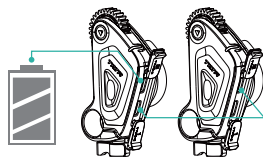

PD电源/V口电池+2个电机+PD供电线 (Type-C to C)

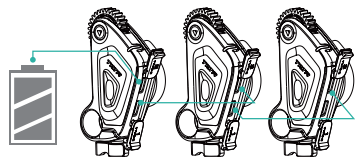

PD电源/V口电池+3个电机+PD供电线 (Type-C to C)

## 使用Type-C to C线

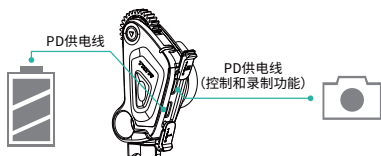

PD电源/V口电池+1个电机+PD供电线 (Type-C to C)+相机

**提示:** 多电机串联时,接口2输入—接口1输出;在串联最后一个电机时,接口1输入—接口2通过PD供电线控制相机。

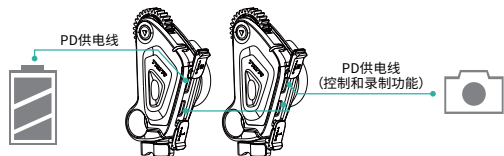

PD电源/V口电池+2个电机+PD供电线 (Type-C to C)+相机

## 使用TILTA专业侧手柄录制线

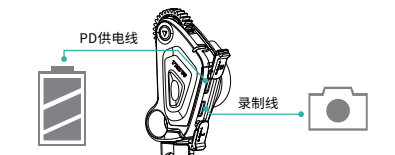

PD电源/V口电池+1个电机+PD供电线 (Type-C to C) (接口2输入)  
+录制线 (接口1输出)

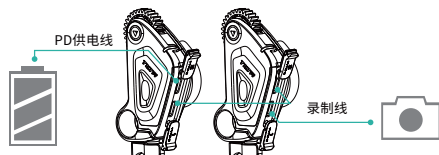

PD电源/V口电池+2个电机+PD供电线 (Type-C to C) (接口2输入)  
+录制线 (接口1输出)+相机

**提示:** 在使用Type-C接口R/S录制线时,PD供电线接口2输入—录制线接口1输出—连接相机,再通对手轮即可控制相机录制启停。

## 07 电机指示灯灯语

○ 白灯:电机无配对状态

紫灯: FOCUS

● 紫灯常亮: 已配对完成, 分配电机至 FOCUS

蓝灯: ZOOM

● 蓝灯常亮: 已配对完成, 分配电机至 ZOOM

绿灯: IRIS

● 绿灯常亮: 已配对完成, 分配电机至 IRIS

黄灯: OTHERS

● 黄灯常亮: 已配对完成, 分配电机至 OTHERS

● 红白灯闪烁: 无线模块配置中

● 绿白灯闪烁: 通道配置中

● 红蓝灯闪烁: 自动校准中

● 黄白灯闪烁: 手动校准中;

● 绿红灯闪烁: 电机解锁中(处于不自锁/不可控状态)

● 红灯闪烁: 电机出现错误

● 紫灯闪烁: 电机 FOCUS, 电压低于 6V

● 绿灯闪烁: 电机 IRIS, 电压低于 6V

● 蓝灯闪烁: 电机 ZOOM, 电压低于 6V

● 黄灯闪烁: 电机 OTHERS, 电压低于 6V

电压小于 6V 时,  
未启用 PD 协议

● 紫青闪烁: 电机 FOCUS, 电压大于 6V

● 绿青闪烁: 电机 IRIS, 电压大于 6V

● 蓝青闪烁: 电机 ZOOM, 电压大于 6V

● 黄青闪烁: 电机 OTHERS, 电压大于 6V

电压大于 6V 时,  
启用 PD 协议

## 原力N II 控制手轮与原力N II 电机配对

01



进入手轮UI主界面,自下向上滑动进入菜单。

02



选择【连接设置】-[2.4G]模式,再打开【ON】并点击【频道】进入自动/手动频道模式。

03

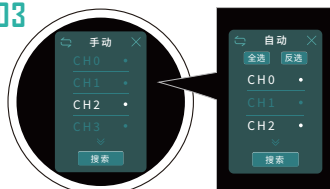

手动频道模式 ↔ 自动频道模式

通过自动/手动频道模式搜索可用频道

**注:** 点击左上角切换图标可切换搜索模式;

自动频道模式可根据网络情况自动选择频道,在菜单中可选择关闭指定频道;手动频道模式可指定单一频道。

04



电机接口1或接口2接上电源后双击【功能键】,电机指示灯闪烁,进入配对状态。待手轮界面上搜索到电机时,点击【确认】,待电机指示灯(紫/绿/蓝/黄)常亮时即配对完成。

## 原力N II 控制手轮与原力M 电机配对 (方法一)

01



进入手轮菜单,选择【连接设置】-[2.4G]模式,再打开【ON】并点击【频道】,切换到手动频道模式,选择可用频道(如CH2),进入【搜索】。

02

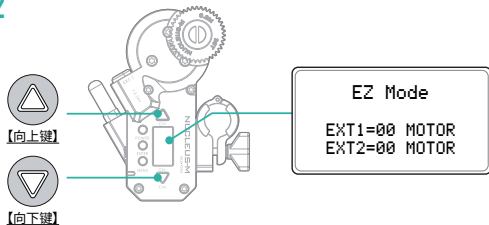

原力M 电机接上电源后,长按【向上键】和【向下键】进行【EZ模式】配对。

03



待手轮界面上搜索到电机时,点击【确认】,完成配对。此时电机屏幕主界面上会显示相应的频道(如02)。

**提示:** 原力N II 控制手轮与原力M 电机或VND电机配对,均通过手轮的【2.4G】手动频道模式进行配对。



# 09 配对操作

## 原力N II 控制手轮与原力M 电机配对(方法二)

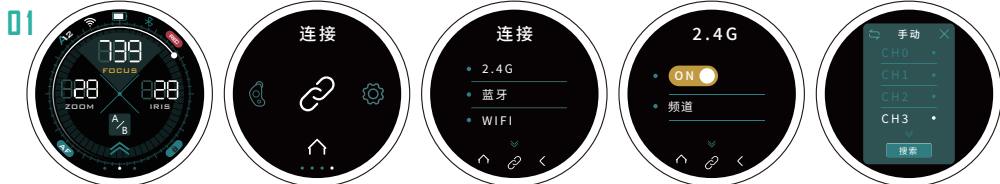

进入手轮菜单,选择【连接设置】-[2.4G]模式,再打开【ON】并点击【频道】进入手动频道模式,选择可用频道(如CH3),然后退出此界面。

### 02

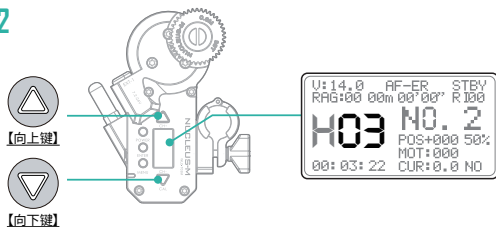

原力M 电机接上电源后,长按【POWER】键开机,通过双击【向上键】或【向下键】调整频道与手轮一致。

## 原力M 电机序号设置

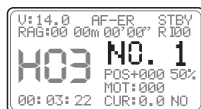
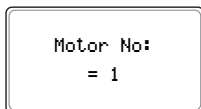
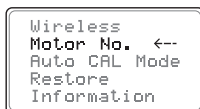
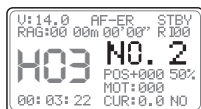

原力M 电机接上电源后,双击【MENU】键进入菜单,选择【Motor No.】按【ENTER】键进入。通过单击【向上键】或【向下键】调整电机序号。调整电机序号1(紫色)、2(绿色)、3(蓝色)、4(黄色),即可使用原力N II 控制手轮或多功能控制手柄的相应部件,控制原力M 电机。

## 原力N II 控制手轮与VND专用电机配对

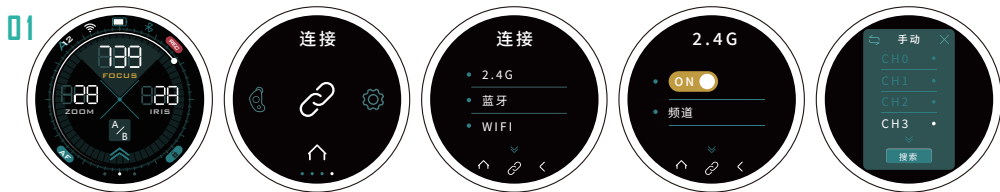

进入手轮菜单,选择【连接设置】-[2.4G]模式,再打开【ON】并点击【频道】进入手动频道模式,选择可用频道(如CH3),然后退出此界面。

### 02

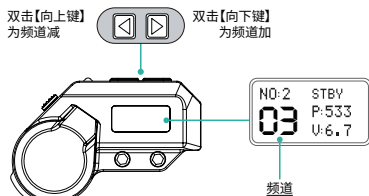

VND电机接上电源后,长按【向下键】开机,通过双击【向上键】或【向下键】调整频道与手轮一致。

三击【向上键】进入电机序号设置:

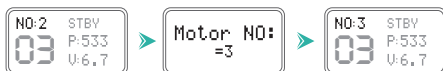

通过单击【向上键】或【向下键】调整电机序号(不操作时10S后自动退出或三击【向上/下键】退出)。

调整电机序号1(紫色)、2(绿色)、3(蓝色)、4(黄色),即可使用原力N II 控制手轮或多功能控制手柄的相应部件,控制VND电机。

# 10 固件更新

## 手轮-固件更新

01 进入手轮UI主界面,自下向上滑动进入菜单。



02 选择【连接设置】-[WIFI]模式,再打开【ON】并点击【设置】进入WIFI搜索模式。



03 点击【搜索】查找可用WIFI,输入密码后确定【OK】,待出现绿色打钩图标✔即联网成功。



04 进入手轮菜单,选择【系统设置】-[固件更新],选择需更新的手轮程序,如【手轮-M】,并点击【确认】进入更新,待更新进度达100%后,菜单界面返回到主界面即更新完成。



提示：仅【手轮-M】程序需要联网更新,其他程序均可在【手轮-M】固件更新完成后在单独离线更新。

## 电机-固件更新

01 在手轮已提前联网更新最新固件的情况下,先按住电机【功能键】①再接上电源②,绿灯短闪,进入电机更新状态;

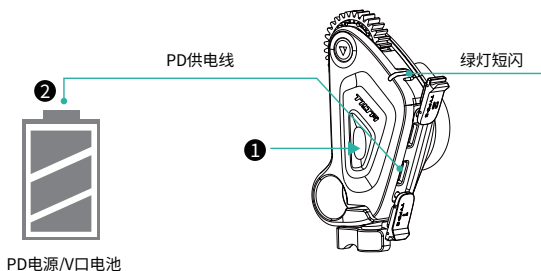

**02** 进入手轮菜单,选择【系统设置】-【固件更新】,选择需更新的电机程序,如【电机-M】,并点击【确认】进入更新,待更新进度达100%后,即更新完成。如需再更新【电机-S】,需先断开电机电源,再重复上述更新操作即可。



- 在手轮已联网的状态下,进入【系统设置】-【固件更新】界面会弹出【服务器】窗口,请根据所在地选择对应的服务器,再进行更新。



- 查看程序是否需要更新:

① 程序下方是否带“→”的版本号,即当前版本需要固件更新,如下。

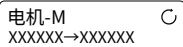

② 程序下方未带“→”的版本号,即当前版本不需要固件更新,如下。



## 原力N II 控制手轮

- 手轮在已联网的状态下,系统会自动检测到最新的固件版本。
- 更新过程中屏幕会重启,请等待更新完成即可,更新完成后手轮菜单会返回到主界面。
- 更新【手轮-M】程序时,会同时下载【手轮-S】/【电机-M】/【电机-S】/【手柄】多个程序的固件,后续更新电机和手柄时无需联网。
- 手轮更新后查看当前固件版本号。
- 手轮在联网状态下更新失败或中断时,请检查网络状态或重启手轮。
- 【手轮-M】程序:手轮主控固件;【手轮-S】程序:手轮外设设备管理固件  
【电机-M】程序:电机端-相机控制固件;【电机-S】程序:电机控制固件  
【控制手柄】程序:多功能控制手柄固件

## 原力N II 电机

- 电机固件更新前,需确保手轮已提前联网更新最新固件。
- 更新前确保手轮电量不低于50%,同时确保区域内没有其他电机正在固件更新。
- 更新过程中请勿插拔电机电源或关闭手轮。如有,电机需再次接上电源,重复更新操作即可。
- 多个电机不能同时进行固件更新,仅能依次更新一台电机,避免信号干扰。
- 当固件更新完,要进行下一个固件更新时需断开电机电源后进行。
- 电机需跟手轮进行配对后才可查看当前固件版本号。
- 电机如果误触【功能键】进入固件更新状态,请先断开电机电源,并未在按压【功能键】的情况下,重新接上电源即可。
- 如果更新的百分数停留在5%-6%之间,或者递增速度过慢,即需要手轮关机重启,再次进行上述更新操作。

Thank you for purchasing a TILTA product.

Before using this product, please carefully read this document to ensure that the product has been set up correctly. The final interpretation of this document and all related documents for this product belongs to TILTA. For updates, please visit the official website at [www.tilta.com](http://www.tilta.com) for the latest product information. TILTA reserves the right to modify any information in this manual at any time without prior notice and without assuming any responsibility.

By using this product, you are deemed to have carefully read the disclaimer and warnings, understood, agreed, and accepted all the terms and content of this statement. You promise to take full responsibility for the use of this product and any consequences that may arise.

You commit to using this product only for legitimate purposes and agree to this term as well as any related regulations, policies, and guidelines set by TILTA.

TILTA is not responsible for any damages, injuries, or legal liabilities caused directly or indirectly by the use of this product. Users should follow all safety guidelines mentioned in this document, including but not limited to those mentioned. Despite the above provisions, consumer rights are still protected by local laws and regulations and are not affected by this disclaimer.

TILTA is a trademark of Shenzhen TILTA Technology Co., Ltd. and its affiliated companies. Product names, brands, and other trademarks appearing in this document are trademarks or registered trademarks of their respective companies.

## WARNING & PRECAUTION

Before using this product, please strictly follow the instructions below. Our company assumes no responsibility for any consequences caused by improper operation or misuse.

### ACCESSORY REQUIREMENTS

- Charging at temperatures higher than 40°C (104°F) or lower than 5°C (41°F) may result in decreased battery performance, swelling, leakage, overheating, and other damage.
- Do not store the battery in an environment exceeding 60°C (140°F). The ideal storage temperature is 22°C (71.6°F) to 28°C (82.4°F).
- The battery must be charged with the charging equipment provided by TILTA. TILTA will not be responsible for any consequences resulting from charging with non-TILTA official equipment.

### OPERATING ENVIRONMENT

- This device contains strong magnets. To avoid magnetic interference, please keep it away from magnetic cards, IC cards, implantable medical devices (such as pacemakers), hard drives, RAM chips, and other devices that may be affected.
- Use the battery in an environment with a temperature between -20°C (-4°F) and 45°C (113°F). Excessive temperatures can cause the battery to swell abnormally, catch fire, or even explode. Before using the device in a low-temperature environment, it is recommended to fully charge the battery at room temperature to extend its service life.
- Do not disassemble or modify the battery near flammable or combustible materials (such as carpets and wooden products) while charging. Always pay attention to the charging process to prevent accidents.
- Store the device in a dry environment, with an ideal storage humidity not exceeding 40%.

### BATTERY SAFETY

- ⚠** [Warning] This device is equipped with a non-removable built-in battery, please do not attempt to replace the battery yourself, as this may damage the battery or the device.
- Do not use the battery in environments with strong electrostatic or magnetic fields, as this may cause internal circuit failures in the device.
  - Do not expose the battery to high temperatures or place it near heat-generating devices, such as sunlight, heaters, microwaves, ovens, or water heaters. Overheating the battery may cause it to explode.
  - Do not disassemble or modify the battery, insert foreign objects, or immerse in water or other liquids, as this may cause the battery to leak, overheat, catch fire, or explode.
  - The electrolyte inside the battery is highly corrosive. If it accidentally comes into contact with your skin or eyes, rinse immediately with clean water for at least 15 minutes and seek medical attention.
  - Do not throw the battery into fire, as this can cause it to catch fire and explode.
  - Do not drop, squeeze, or puncture the battery. Avoid subjecting the battery to external pressure, which may cause internal short circuits and overheating.
  - Do not use damaged batteries.
  - Do not store the battery for an extended period after it has been completely discharged, to avoid entering a deep discharge state that can cause damage to the battery cells, rendering it unable to be used again.
  - Be sure to fully discharge the battery before disposing of it in a designated battery recycling bin. Batteries are hazardous chemicals and must not be disposed of in regular trash bins. For details, please follow the local laws and regulations regarding battery recycling and disposal.
  - If the battery cannot be fully discharged, do not dispose of it directly in a battery recycling bin; instead, contact a professional battery recycling company for further processing.

### MAINTENANCE & CARE

- Please keep the device clean and free of sand, dust, and other foreign objects. Use a clean, dry cloth to promptly clean any debris on the product.
- Do not subject the device and its accessories to strong impacts or vibrations, as this may damage them and cause device failure.
- If the device collides with a hard object or the screen is broken due to a strong external impact, do not touch or attempt to remove the broken parts. Instead, immediately stop using the device and promptly contact TILTA customer service.

**NOTE:** The device will generate slight heat during operation, which is normal.

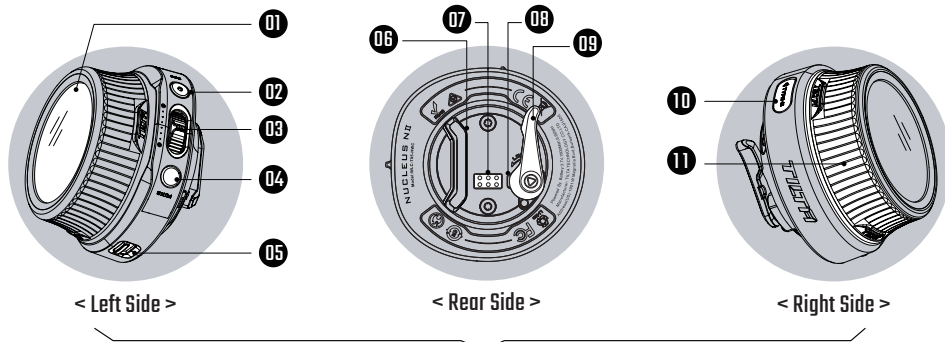

**01** 1.6-inch Circular Touch Screen  
Lens & Camera Data/Parameter Display & Control

**02** [REC] Button  
01 Single Press: REC Run/Stop Function  
02 Long Press 3s: Power On/Off  
03 Long Press 8s: Force Power Off

**03** Control Rocker  
Control One Assigned Motor

**04** [FUNC] Button  
01 Set Marks  
02 Hold to Calibrate Lens

**05** Rotation Limit Switch  
Switch TF/DF Mode  
(TF Mode: Compatible with TILTA Wireless Follow Focus Systems;  
DF Mode: Compatible with DJI Follow Focus Systems)



↑ Switch Up to TF Mode ( Limits Focus Knob Rotation to 360 Degrees )

↓ Switch Down to DF Mode ( Focus Knob can Rotate Freely )

**06** NATO Mount  
For Mounting the Hand Unit

**07** Electronic Contact Points  
01 Power the hand wheel controller via the Power Handle or Control Handle  
02 Compatible with other external devices for data transmission

**08** Safety Pin  
Prevents Accidental Disconnection

**09** Tie Down  
Lock to Secure a NATO Accessory

**10** USB-C Port  
For PD Fast Charging

**11** Hand Wheel  
Motor/Parameter Control

## FEATURES



Circular Touch Screen  
Dynamic Interaction/350ppi



USB-C  
Supports PD Fast Charging



Built-in High Capacity Battery  
with Extended Life  
Continuous Operation for Over 7 Hours  
& Smart Standby up to 20 Hours

## TECHNICAL DATA

● Material: Aluminum Alloy+Plastic

● Dimensions: 73\*72\*53mm

● Weight : 175g

● Color : Black

## BATTERY USAGE GUIDELINE



Built-in Battery Capacity  
**3.7V 1800mAh 6.66Wh**

(1) Operating Temperature: Charging: 0°C to 45°C (32°F to 113°F); Discharging: -10°C to 60°C (14°F to 140°F)

(2) Storage Temperature: -5°C to 45°C (23°F to 113°F)

(3) Operating Humidity: 45±20% (Recommended)

(4) Warranty Period: 12 months and less than 500 charge cycles

# 14 USE THE HAND UNIT

## USE INDEPENDENTLY

The focus motor can be controlled by operating the hand wheel or using the control rocker.

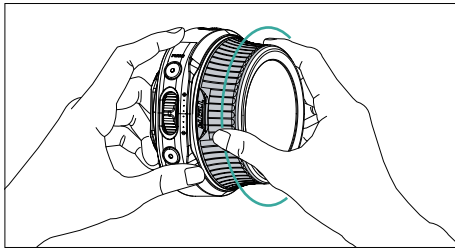

The Nucleus-N II and some camera settings can be controlled through the touch screen.

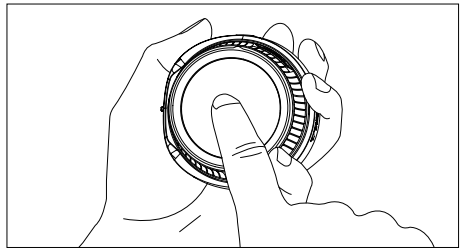

## ATTACH TO OTHER ACCESSORIES

The Nucleus-N II hand unit features a NATO quick-release mount, allowing it to be attached to NATO rail. (such as NATO rail on the side of a camera cage or DJI RS 2/RS 3 Pro, etc..)

**Note:** When assembling and disassembling, pay attention to the contact pins on the Control Handle to prevent damage from external force.

### USE WITH THE NUCLEUS NANO II CONTROL HANDLE (as shown below)

Attach the hand unit to the Control handle using the NATO mount, lock the tie down to secure.

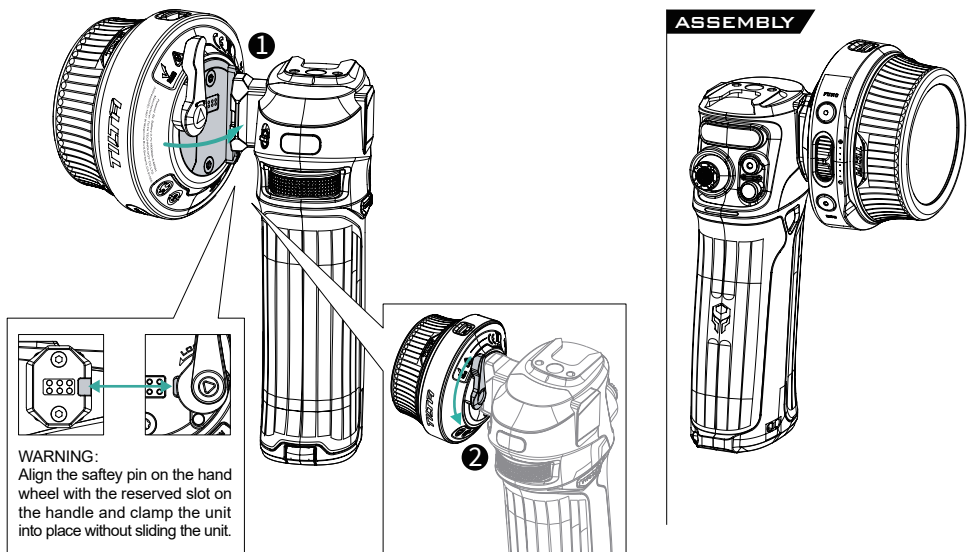

The Nucleus-N II hand unit UI consists of Three Main Screens and Four Settings Menus. The Three Main Screens include the Camera Control Interface, Motor Parameter Interface, and Focus Distance Interface. The Four Settings Menus are Connect Settings, Function Settings, System Settings, and Motor Settings.

After turning on the device, the hand wheel controller will enter the main Interface. Swipe left or right to switch between the Three Main Screens. Swipe up from the bottom of the screen to access the Four Settings Menus. Swipe left or right to select the desired settings menu and tap the center icon to enter the secondary menu.

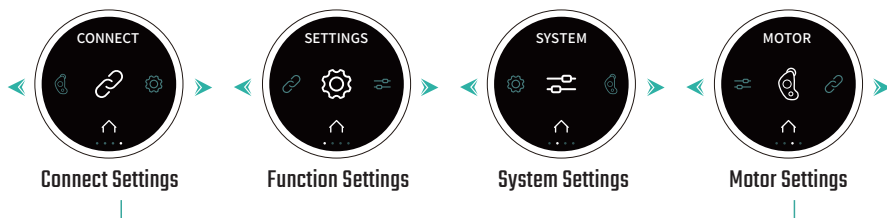

Swipe up from the bottom



Camera Control Interface- REC

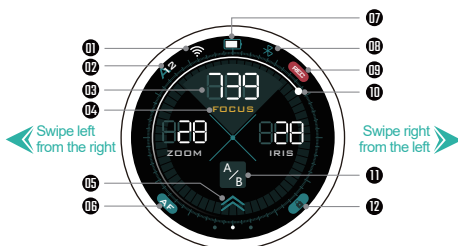

Motor Parameter Interface



Focus Distance Interface



Camera Control Interface- STBY

- 13 Camera Settings Lock Button
- 14 REC/STBY Indicator
- 15 Iris Info
- 16 ISO Info
- 17 Communication Protocol Info
- 18 Recording Run Time
- 19 Shutter Speed Info
- 20 Color Temperature Info
- 21 Resolution/ Data Rate/ Frame Rate

- 01 WIFI Status
- 02 Wireless Channel Indicator  
A: Automatic Channel Mode  
M: Manual Channel Mode  
Number: Channel No.
- 03 Motor Parameter (0-999)
- 04 Motor Indicator  
FOCUS Indicator / IRIS Indicator / ZOOM Indicator
- 05 Additional Settings (Swipe Up)
- 06 AF/MF Switch Button
- 07 Battery Information
- 08 Bluetooth Status
- 09 REC/STBY Indicator
- 10 Focus Knob Range Indicator
- 11 Set Mark Button
- 12 Touch Screen Lock Button

- 22 Focus Distance
- 23 Lens Manufacturer
- 24 Lens Model
- 25 Focal Length Info
- 26 Set Mark Button

# 16 INTRODUCING NUCLEUS NII MOTOR

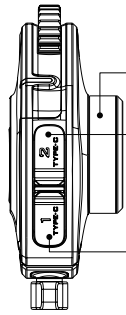

< Left Side >

- 01 Motor Driver
- 02 USB-C Port 2  
Supports PD input,  
(input voltage: 7.4V-16.8V)  
Supports USB-C to C  
control cables
- 03 USB-C Port 1  
Supports PD Input/Output,  
(input voltage: 7.4V-16.8V)  
Supports USB-C Run/ Stop  
cables

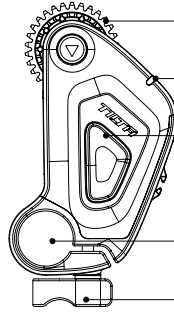

< Rear Side >

- 04 0.8M Lens Gear  
Connects to Lens
- 05 LED Indicator
- 06 Function Button  
Single-Click : Switch Motor  
FOCUS/IRIS/ZOOM/OTHERS  
Double-Click : Enter Pairing Mode  
Long Press 3s : Calibrate Lens
- 07 15mm Rod Holder  
For Mounting via a 15mm Rod
- 08 Tie Down  
For securing the Motor

## TECHNICAL DATA

- Material: Aluminum Alloy+Plastic
- Dimensions: 83\*46\*31mm
- Weight: 80g
- Color: Black

## ATTACHING MOTOR TO LENS

### (1) Attaching Lens Gears

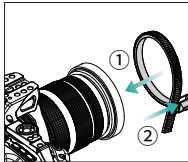

Attach part ① lens gear to the lens, following the indicated direction. Secure part ② to complete the assembly.

**Note:** Compatible with focus rings with a 0.8 gear pitch, can be used with the adjustable lens gear included in the kit or the TILTA Seamless Focus Gear Ring (Optional).

Note: If the lens comes with a 0.8 module gear ring, skip this step.

### (2) Attaching the Rod Holder & 15mm Rod

Attach the ③ rod holder to the 1/4" thread on the cage side arm, and tighten the screw. Then, secure the 15mm rod ④ to the rod holder, which will be used to attach the motor.

### (3) Attaching the Motor

Mount the ⑤ motor onto the 15mm rod, adjust the motor angle, and then engage the motor gear with the adjustable lens gear and then tighten the tie down ⑥ to complete the assembly.

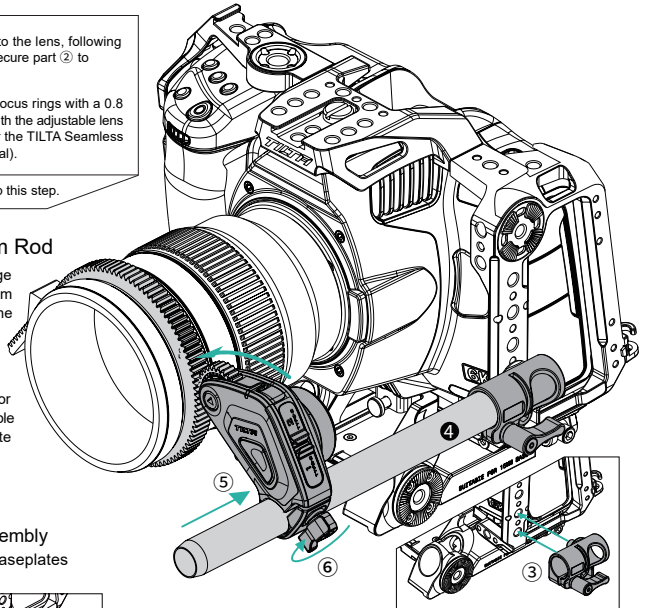

Optional TILTA rod adapters for motor assembly  
Including: 15mm Single Rod Holders and LWS Baseplates

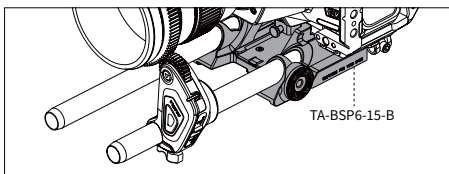

TA-BSP6-15-B



# 17 MOTOR POWERING GUIDELINE

You can use TILTA's Universal Power Bank Holder or TILTA's L Series Battery Plate (Optional) for supporting various power options, in order to supply power to the focus motor via the USB-C port (PD protocol).

## Attaching the Universal Power Bank Holder (TA-UPBH-B)

Attach the Universal Power Bank Holder to a 1/4"-20 thread. Tighten the screw and then secure the power supply equipment (such as a power bank).

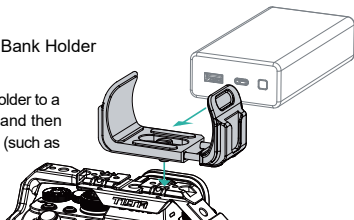

## Attaching the Tilta L Series Battery Plate (TA-BTP2-F970-B)

Attach the Battery Plate to a 1/4"-20 thread. Tighten the screw and then secure the power supply equipment (such as an F970/F550 battery).

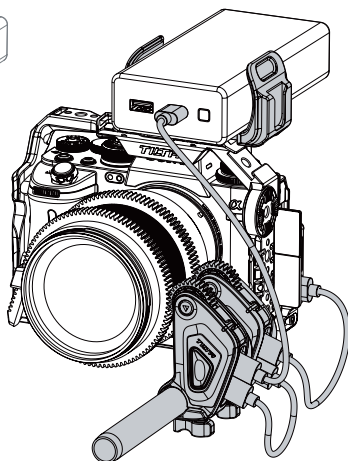
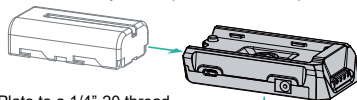

## MOTOR CABLE SETUP

**Note:** When using multiple motors, you can connect them in series by using the USB-C (PD protocol) for passthrough power.

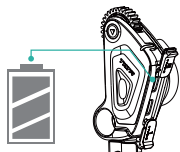

Power Source + 1 Motor + PD Power Cable (USB-C to C)

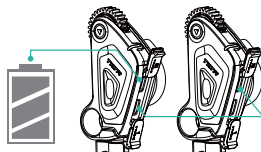

Power Source + 2 Motors + PD Power Cable (USB-C to C)

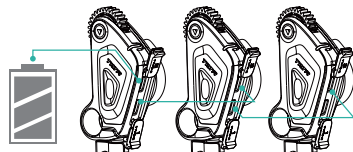

Power Source + 3 Motors + PD Power Cable (USB-C to C)

## USB-C TO C CABLE

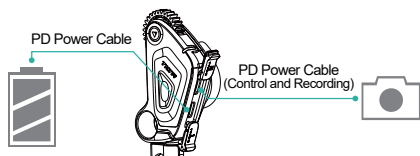

Power Source + 1 Motor + PD Power Cable (USB-C to C) + Camera

**Note:** When connecting multiple motors in series, use Port 2 as the power input for the first motor and connect the second motor via Port 1 on both motors. Use Port 2 on the last motor to connect to the camera.

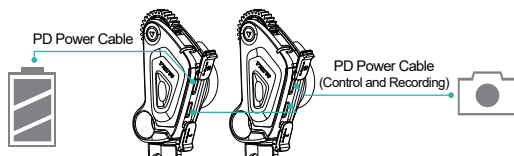

Power Source + 2 Motors + PD Power Cable (USB-C to C) + Camera

## USB-C RUN/STOP CABLE

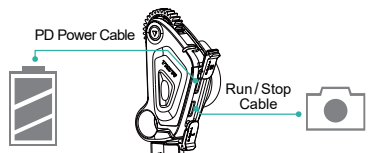

Power Source + 1 Motor + PD Power Cable (USB-C to C) (Port 2 Input) + Run/Stop Cable (Port 1 Output)

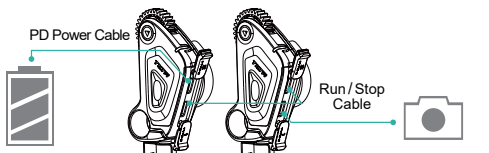

Power Source + 2 Motors + PD Power Cable (USB-C to C) (Port 2 Input) + Run/Stop Cable (Port 1 Output) + Camera

**Note:** When using a USB-C Run Stop Cable, use Port 2 as the power input for the first motor and connect the next motor from Port 1 to Port 2, leaving Port 1 on the last motor open for the Run/Stop Cable.

○ White: Motor is not assigned to any function

Purple: FOCUS

● Purple Light: Pairing completed, motor assigned to FOCUS.

Green: IRIS

● Green Light: Pairing completed, motor assigned to IRIS.

Blue: ZOOM

● Blue Light: Pairing completed, motor assigned to ZOOM.

Yellow: OTHERS

● Yellow Light: Pairing completed, motor assigned to OTHERS.

● Red & White Lights Flashing: Wireless module configuration in progress

● Green & White Lights Flashing: Channel configuration in progress

● Red & Blue Lights Flashing: Automatic calibration in progress

● Yellow & White Lights Flashing: Manual calibration in progress

● Green & Red Lights Flashing: Motor unlocking (non-controllable state)

● Red Light Flashing: Motor Error Detected

● Purple Light Flashing: Motor FOCUS, voltage below 6V

● Green Light Flashing: Motor IRIS, voltage below 6V

● Blue Light Flashing: Motor ZOOM, voltage below 6V

● Yellow Light Flashing: Motor OTHERS, voltage below 6V

Voltage below 6V, PD protocol disabled

● Purple & Cyan Lights Flashing: Motor FOCUS, voltage above 6V

● Green & Cyan Lights Flashing: Motor IRIS, voltage above 6V

● Blue & Cyan Lights Flashing: Motor ZOOM, voltage above 6V

● Yellow & Cyan Lights Flashing: Motor OTHERS, voltage above 6V

Voltage above 6V, PD protocol enabled

## THE NUCLEUS-N II HAND UNIT PAIRING WITH THE NUCLEUS-N II MOTOR

01



Enter the hand wheel controller's main interface, swipe from bottom to top to access the menu

02

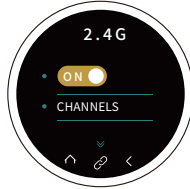

Choose **【CONNECT】** - **【2.4 G】** mode, then turn **【ON】** and click **【CHANNELS】** to enter the Auto/Manual Channel mode.

03

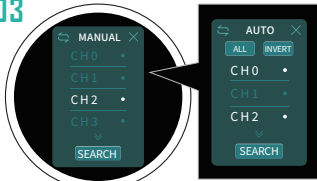

Manual Channel Mode ↔ Auto Channel Mode  
Search for available channels through Auto/Manual Channel mode

04

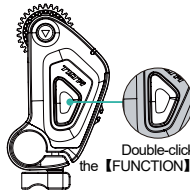

Double-click the **【FUNCTION】** Button



After connecting power to motor port 1 or port 2, Double-click the **【FUNCTION】** Button, the indicator light will flash, indicating it's in pairing mode. When the motor is detected on the hand wheel controller's interface, click **【CONFIRM】**, when the motor indicator light (purple/green/blue/yellow) remains constant, pairing is completed.

**Note:** Click the top-left corner switch icon to switch search modes; Auto Channel Mode can automatically select channels based on network conditions, with the option to disable specific channels in the menu; Manual Channel Mode allows specifying a single channel.

## THE NUCLEUS-N II HAND UNIT PAIRING WITH THE NUCLEUS-M MOTOR (METHOD 1)

01

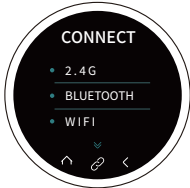

Enter the hand wheel controller's menu, select **【CONNECT】** - **【2.4 G】** mode, then turn **【ON】** and click **【CHANNELS】** to switch to manual channel mode. Select an available channel (e.g., CH2), then **【SEARCH】**.

02

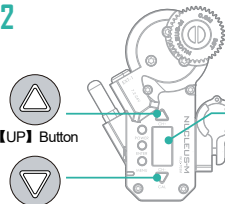

**【UP】** Button

**【DOWN】** Button

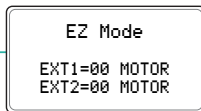

After connecting power to Nucleus-M motor, long-press the **【UP】** and **【DOWN】** button to initiate **【EZ Mode】** pairing.

03

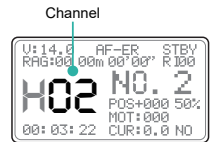

After finding the motor on the hand wheel controller's interface, click **【CONFIRM】** to complete pairing. The motor's screen will display the corresponding channel (e.g., 02).

**Note:** The Nucleus-N II hand unit pairs with both the Nucleus-M motor and VND motor through the hand unit **【2.4 G】** manual channel mode.

## THE NUCLEUS-N II HAND UNIT PAIRING WITH THE NUCLEUS-M MOTOR (METHOD 2)

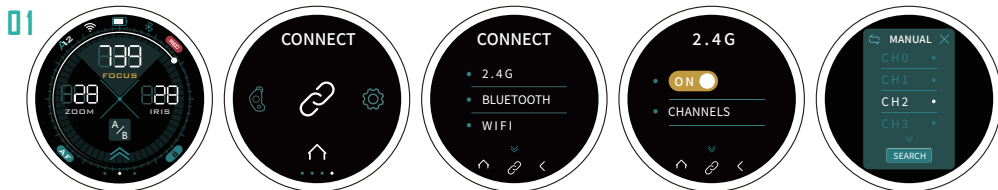

Enter the hand wheel controller's menu, select **[CONNECT]** - **[2.4 G]** mode, then turn **[ON]** and click **[CHANNELS]** to switch to manual channel mode. Select an available channel (e.g., CH3), then exit this interface.

02

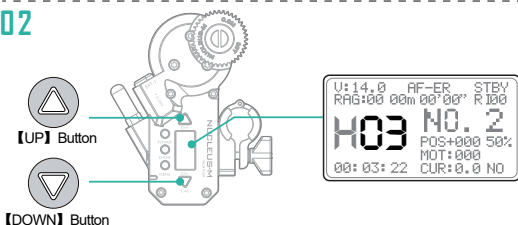

After connecting power to the Nucleus-M motor, long-press the **[POWER]** button to power on. Adjust the channel to match the hand unit by double-clicking the **[UP]** or **[DOWN]** button.

## THE NUCLEUS-M MOTOR NUMBER SETTING

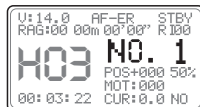
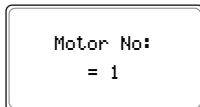
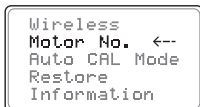
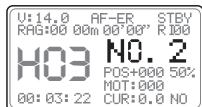

After connecting power to the Nucleus-M motor, double-click the **[MENU]** button to access the menu. Select **[MOTOR NO.]**, press **[ENTER]**, and adjust the motor number by clicking the **[UP]** or **[DOWN]** button. Adjust the motor number to 1 (purple), 2 (green), 3 (blue), or 4 (yellow) to control the Nucleus-M motor by using the corresponding components of the Nucleus-N II hand wheel controller or multi-functional control handle.

## THE NUCLEUS-N II HAND UNIT PAIRING WITH VND MOTOR

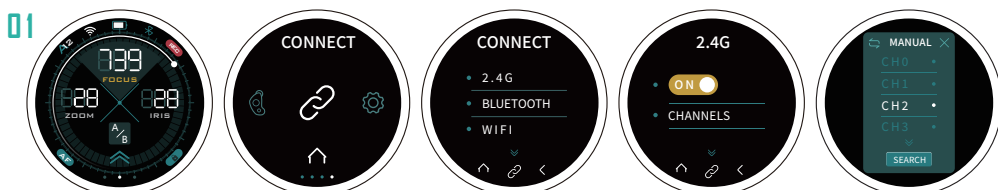

Enter the hand wheel controller's menu, select **[CONNECT]** - **[2.4 G]** mode, then turn **[ON]** and click **[CHANNELS]** to switch to manual channel mode. Select an available channel (e.g., CH3), then exit this interface.

02 Double-click the **[UP]** button to subtract a channel. Double-click the **[DOWN]** button to add a channel

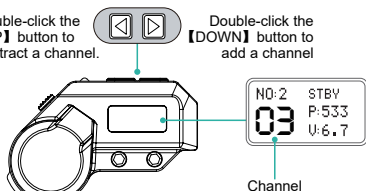

After connecting power to the VND motor, press and hold the **[DOWN]** button to power it on. Adjust the channel to match the handwheel by double-clicking the **[UP]** or **[DOWN]** button.

Triple-click the **[UP]** button to enter the motor number setting:

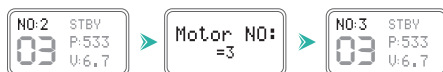

Adjust the motor number by clicking the **[UP]** or **[DOWN]** button (it will automatically exit after 10 seconds of inactivity, or you can exit by triple-clicking the **[UP/DOWN]** button). Assign motor numbers 1 (purple), 2 (green), 3 (blue), and 4 (yellow) to control the corresponding components via the Nucleus-N II hand wheel controller or multifunction control handle to operate the motor.

## HAND WHEEL CONTROLLER - FIRMWARE UPDATE

**01** Enter the hand wheel controller's main interface, swipe from bottom to top to access the menu.



**02** Choose **CONNECT** - **WIFI** mode, then turn **ON** and click **SETTINGS** to enter the WIFI searching mode.

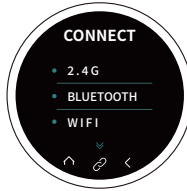

**03** Click on **SEARCH** to find available WiFi networks, enter the password, then click **OK**, when the green check mark icon appears, the connection is successful.



**04** Enter the hand wheel controller's menu, select **SYSTEM** - **FIRMWARE UPDATE**, choose to update the hand wheel **HAND WHEEL-M**, and click **CONFIRM** to start the update. Once the update progress reaches 100%, the update is complete and the menu will return to the main interface.

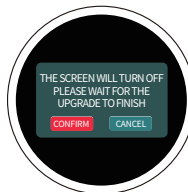

**Note:** Only the **HAND WHEEL-M** hardware requires online updates, while other hardware can be updated offline once the **Hand Wheel-M** component update is completed.

## MOTOR - FIRMWARE UPDATE

**01** If the hand wheel controller has already been updated press and hold the motor's **FUNCTION** button ① and then connect power ②. A green light will flash briefly, which means the motor is in update mode.

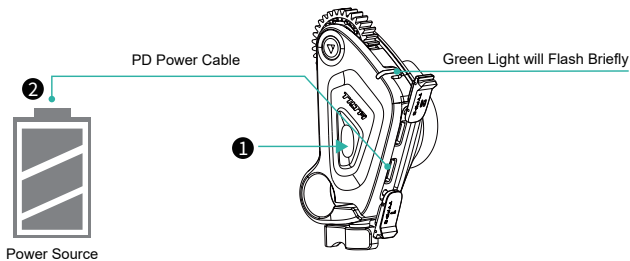

- 02** Enter the hand wheel controller's menu, select **【SYSTEM】 - 【FIRMWARE UPDATE】**, choose to update the motor, such as **【MOTOR-M】** and click **【CONFIRM】** to start the update. Once the update progress reaches 100%, the update is complete. If you need to update **【MOTOR-S】** afterward, you should first disconnect the motor's power and then repeat the above update process.

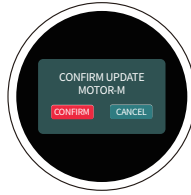

- When the hand wheel controller is already connected to the internet, access **【SYSTEM】 - 【FIRMWARE UPDATE】**. A **【SERVER】** window will pop up. Please select the appropriate server based on your location, and then proceed with the update.



- To check if the hardware needs an update:

① Check if there is a version number with an arrow "→" below the hardware. If there is, it means the current version requires a firmware update, as shown below.

MOTOR-M  
XXXXXX→XXXXXX

② If there is no version number with an arrow "→" below the hardware, it means the current version does not require a firmware update, as shown below.

MOTOR-M  
XXXXXX

## NUCLEUS NANO II HAND WHEEL CONTROLLER

- When the hand wheel controller is connected to the internet, the system will automatically detect the latest firmware version.
- During the update process, the screen will restart. Please wait for the update to complete. After finishing, the controller's menu will return to the main interface.
- When updating the **【HAND WHEEL-M】** hardware, firmware for other hardware such as **【HAND WHEEL-S】**, **【MOTOR-M】**, **【MOTOR-S】**, and **【CONTROL HANDLE】** will be downloaded simultaneously. Subsequent updates for motors and handles will not require an internet connection.
- After updating the handwheel, check the current firmware version.
- If the controller fails to update in a connected state or if the update is interrupted, please check the network status or restart the controller.
- 【HAND WHEEL-M】**: Hand Wheel main control firmware  
**【HAND WHEEL-S】**: Hand Wheel peripheral device management firmware  
**【MOTOR-M】**: Motor-end camera control firmware; **【MOTOR-S】**: Motor control firmware  
**【CONTROL HANDLE】**: Control handle firmware

## NUCLEUS NANO II MOTOR

- Before updating the motor firmware, make sure that the hand wheel controller has previously updated to the latest version.
- Before updating, ensure that the hand wheel controller has a battery level of at least 50% and no other motors are currently undergoing a firmware update.
- During the update process, do not plug or unplug the motor's power or turn off the hand wheel controller. If this happens, reconnect the motor's power and repeat the update operation.
- Multiple motors cannot undergo firmware updates simultaneously. Only one motor can be updated at a time to avoid signal interference.
- When completing firmware updates, if proceeding with the next firmware update, you need to disconnect the motor's power before proceeding.
- The motor needs to be paired with the hand wheel controller before viewing the current version number of the firmware update.
- If the motor accidentally enters firmware update mode by pressing the **【FUNCTION】** button, please disconnect the motor's power first and reconnect power.
- If the update progress remains between 5% and 6%, or if the download speed is too slow, please turn off the hand wheel controller and restart it. Then repeat the above-mentioned update steps.

## IC CAUTION:

(English)

This device complies with Industry Canada licence-exempt RSS standard(s).

Operation is subject to the following two conditions:

- (1) This device may not cause interference, and
- (2) This device must accept any interference, including interference that may cause undesired operation of the device.

To maintain compliance with RSS-102 RF Exposure guidelines, This equipment should be installed and operated with minimum 20cm distance between the radiator and your body: Use only the supplied antenna.

(French)

Le présent appareil est conforme aux CNR d'Industrie Canada applicables aux appareils radio exempts de licence.

L'exploitation est autorisée aux deux conditions suivantes:

- (1) l'appareil ne doit pas produire de brouillage, et
- (2) l'utilisateur de l'appareil doit accepter tout brouillage radioélectrique subi, même si le brouillage est susceptible d'en compromettre le fonctionnement.

Pour être conforme aux lignes directrices d'exposition RF RSS-102, cet équipement doit être installé et exploité à une distance minimale de 20cm entre le radiateur et votre corps: n'utilisez que l'antenne fournie.

## FCC WARNING:

This device complies with part 15 of the FCC Rules. Operation is subject to the following two conditions:

- (1) this device may not cause harmful interference, and
- (2) this device must accept any interference received, including interference that may cause undesired operation.

Any changes or modifications not expressly approved by the party responsible for compliance could void the user's authority to operate the equipment.

NOTE: This equipment has been tested and found to comply with the limits for a Class B digital device, pursuant to Part 15 of the FCC Rules. These limits are designed to provide reasonable protection against harmful interference in a residential installation. This equipment generates, uses and can radiate radio frequency energy and, if not installed and used in accordance with the instructions, may cause harmful interference to radio communications.

However, there is no guarantee that interference will not occur in a particular installation. If this equipment does cause harmful interference to radio or television reception,

which can be determined by turning the equipment off and on, the user is encouraged to try to correct the interference by one or more of the following measures:

- Reorient or relocate the receiving antenna.
- Increase the separation between the equipment and receiver.
- Connect the equipment into an outlet on a circuit different from that to which the receiver is connected.
- Consult the dealer or an experienced radio/TV technician for help.

To maintain compliance with FCC's RF Exposure guidelines, This equipment should be installed and operated with minimum 20cm distance between the radiator and your body: Use only the supplied antenna.

# TILTA

## NUCLEUS NANO II WIRELESS LENS CONTROL SYSTEM

---

For more instructions, please scan the QR code in the image. Enter the model number WLC-T05 to obtain the electronic version of the product manual.

更多操作说明请扫描图中二维码, 输入相关产品型号(WLC-T05), 获取产品电子版说明书。

[WWW.TILTA.COM](http://WWW.TILTA.COM)



关注微信公众号  
Scan to follow Tilta WeChat account



扫码进入官网  
Scan the QR code to enter Tilta website