

Canon EF^S LENS

EF-S18-55mm f/4-5.6 IS STM



IMAGE STABILIZER

ENG

Instructions

Thank you for purchasing a Canon product.

The Canon EF-S18-55mm f/4-5.6 IS STM is a standard zoom lens for EOS cameras* that support EF-S lenses.

* The lens can only be used with compatible EOS cameras. For compatibility information, please check the camera's instruction manual, product catalog or the Canon website.

- "IS" stands for Image Stabilizer.
- "STM" stands for stepping motor.

Camera Firmware

- Please use the latest version of firmware with the camera in use. For details on whether the firmware is the latest version or not, and for details on updating the firmware, please check the Canon website.

Conventions used in this instruction



Warning to prevent lens or camera malfunction or damage.



Supplementary notes on using the lens and taking pictures.

Safety Precautions

Precautions to ensure that the camera is used safely. Read these precautions thoroughly. Make sure all details are observed in order to prevent risks and injury to the user and other people.

 **Warning** Details pertaining to risks that may result in death or serious injury.

- **Do not look at the sun or a bright light source through the lens or single-lens reflex camera.** Doing so could result in loss of vision. Looking at the sun directly through the lens is especially hazardous.
- **Whether it is attached to the camera or not, do not leave the lens under the sun without the lens cap attached.** This is to prevent the lens from concentrating the sun's rays, which could cause a fire.

 **Caution** Details pertaining to risks that may result in injury.

- **Do not leave the camera in locations subject to high or low temperatures.** This may result in the camera becoming excessively hot or cold, which may cause burns or other injuries when touched.

Caution Details pertaining to risks that may result in damage to property.

- Do not leave the lens in excessive heat such as in a car in direct sunlight. High temperatures can cause the lens to malfunction.

General Precautions

Handling Precautions

- If the lens is taken from a cold environment into a warm one, condensation may develop on the lens surface and internal parts. To prevent condensation in this case, first put the lens into an airtight plastic bag before taking it from a cold to warm environment. Then take out the lens after it has warmed gradually. Do the same when taking the lens from a warm environment into a cold one.
- Please also read any lens related handling precautions listed in your camera's instruction manual.

Shooting Precautions

The lens utilizes a stepping motor to move the focus lens when the power is switched on and during zooming.

1. Initial focus lens resetting operations

The lens performs an initial reset of the focus lens when the camera is switched on. When the lens is attached to the following cameras*, an initial reset will be performed, as when operation is resumed from an auto power off state.

- The lens will move in and out of focus during initial reset.

2. Lens sleep mode

When the camera is ON, the lens will enter the sleep mode in order to conserve power if it is not operated for a certain period of time. The lens will also constantly be in the sleep mode when the camera's auto power off function is in effect. The focus lens will not be operated when the lens is in the sleep mode.

- Focusing by rotating the focusing ring is not possible when the lens is in the sleep mode.
- The lens will move in and out of focus if the zoom ring is rotated when the lens is in the sleep mode.

To exit sleep mode, press the shutter button halfway.

* Applicable to the following cameras:

EOS 7D Mark II, EOS 7D, EOS 70D, EOS 60D, EOS 60Da, EOS 50D, EOS 40D, EOS 30D, EOS 20D, EOS 20Da, EOS REBEL T3i/600D, EOS REBEL T2i/550D, EOS REBEL T1i/500D, EOS REBEL XSi/450D, EOS REBEL T5/1200D, EOS REBEL T3/1100D, EOS REBEL XS/1000D, EOS DIGITAL REBEL XTi/400D DIGITAL, EOS DIGITAL REBEL XT/350D DIGITAL, EOS DIGITAL REBEL/300D DIGITAL

This device complies with Part 15 of the FCC Rules.

Operation is subject to the following two conditions: (1) This device may not cause harmful interference, and (2) this device must accept any interference received, including interference that may cause undesired operation.

Do not make any changes or modifications to the equipment unless otherwise specified in the instructions. If such changes or modifications should be made, you could be required to stop operation of the equipment.

This equipment has been tested and found to comply with the limits for a class B digital device, pursuant to part 15 of the FCC Rules. These limits are designed to provide reasonable protection against harmful interference in a residential installation. This equipment generates, uses and can radiate radio frequency energy and, if not installed and used in accordance with the instructions, may cause harmful interference to radio communications.

However, there is no guarantee that interference will not occur in a particular installation. If this equipment does cause harmful interference to radio or television reception, which can be determined by turning the equipment off and on, the user is encouraged to try to correct the interference by one or more of the following measures:

- Reorient or relocate the receiving antenna.
- Increase the separation between the equipment and receiver.
- Connect the equipment into an outlet on a circuit different from that to which the receiver is connected.
- Consult the dealer or an experienced radio/TV technician for help.

Nomenclature

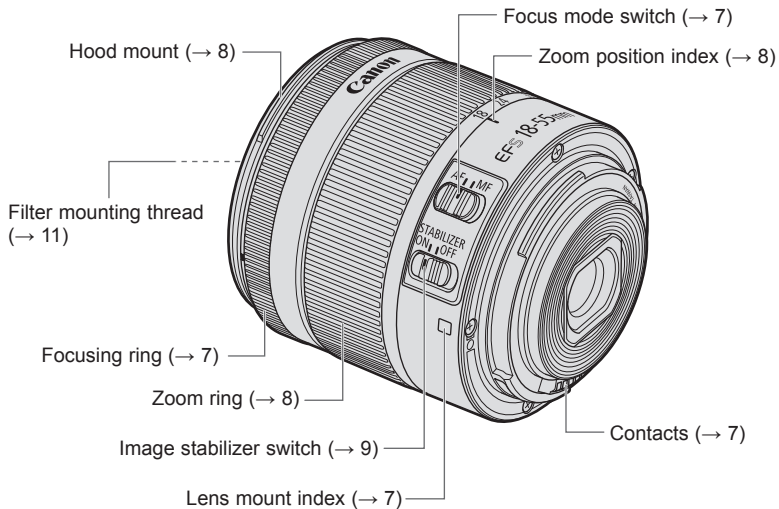

● For detailed information, reference page numbers are provided in parentheses (→ **).

1 Mounting and Detaching the Lens

See your camera's instructions for details on mounting and detaching the lens.

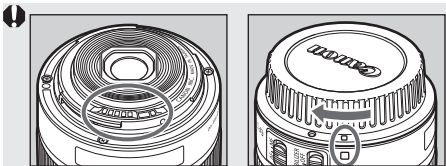

- After detaching the lens, place the lens with the rear end up to prevent the lens surface and contacts from getting scratched.
- Contacts that are scratched, soiled, or have fingerprints on them may result in faulty connections or corrosion, which may lead to malfunctions. If the contacts get soiled, clean them with a soft cloth.
- Attach the lens cap and dust cap when disconnecting the lens. When attaching the dust cap, align the lens mount index with the □ index of the dust cap and rotate in a clockwise direction as shown in the illustration. Follow the reverse procedure to detach it.

2 Setting the Focus Mode

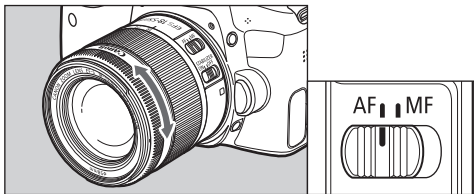

To shoot in autofocus (AF) mode, set the focus mode switch to AF.

To use only manual focusing (MF), set the focus mode switch to MF, and focus by turning the focusing ring.

When AF operation is set to [ONE SHOT], manual focus is possible after autofocus has been completed by continuing to press the shutter button halfway (Full-time manual focus). There are times when camera setting changes are required.

- Quickly rotating the focusing ring may result in delayed focus.
- Focusing by rotating the focusing ring is not possible when the camera is OFF.

3 Zooming

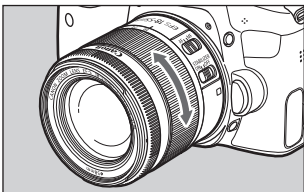

To zoom, turn the lens' zoom ring.

- Be sure to finish zooming before focusing. Zooming after focusing can affect the focus.
- Blurring may temporarily occur if the zoom ring is quickly rotated.
- The lens will move in and out of focus if the zoom ring is rotated when the camera is OFF.
- Zooming during still image exposure will result in delayed focus. This causes any streaks of light that are captured during exposure to be blurred.

4 Hood (sold separately)

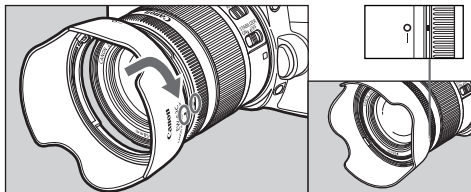

The EW-63C hood cuts out unwanted light and protects the front of the lens from rain, snow, and dust.

To attach the hood, align the hood's attachment position mark with the red dot on the front of the lens, then turn the hood as shown by the arrow until the lens' red dot is aligned with the hood's stop position mark.

The hood can be reverse-mounted on the lens for storage.

- If the hood is not attached properly, vignetting (darkening of the perimeter of the picture) may occur.
- Grasp and rotate the base of the hood when attaching and detaching it. There are cases in which it may become deformed if the hood is rotated with it grasped near to the rim.

5 Image Stabilizer

You can use the image stabilizer in AF or MF mode.

This function provides optimal image stabilization depending on shooting conditions (such as shooting still subjects and following shots).

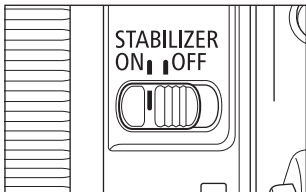

1 Set the STABILIZER switch to ON.

- If you are not going to use the image stabilizer function, set the switch to OFF.

2 When you press the shutter button halfway, the Image Stabilizer will start operating.

- Make sure the image in the viewfinder is stable, then press the shutter button the rest of the way down to take the picture.

- The Image Stabilizer cannot compensate for a blurred shot caused by a subject that moved.
- The Image Stabilizer may not be fully effective if you shoot from a violently shaking vehicle or other transportation.
- The Image Stabilizer consumes more power than normal shooting, resulting in fewer shots and a shorter movie shooting time.

- When shooting a still subject, it compensates for camera shake in all directions.
- It compensates for vertical camera shake during following shots in a horizontal direction, and compensates for horizontal camera shake during following shots in a vertical direction.
- When you use a tripod, the Image Stabilizer should be turned off to save battery power.
- Even with a monopod, the Image Stabilizer will be as effective as during hand-held shooting. However, depending on the shooting conditions, there are cases in which the Image Stabilizer effect may be less effective.
- The image stabilizer function also operates when the lens is used with an extension tube EF12 II or EF25 II.
- The Image Stabilizer will operate even when you press the button assigned to the AF function with the camera's Custom Functions.

Image Stabilizer

The image stabilizer for this lens is effective for hand-held shots in the following conditions.



ON

OFF



ON

OFF

- In semi-darkened areas such as indoors or outdoors at night.
- In locations where flash photography is prohibited, such as art museums and theater stages.
- In situations where your footing is uncertain.
- In situations where fast shutter settings cannot be used.
- When panning subjects in motion.

6 Filters (sold separately)

You can attach filters to the filter mounting thread on the front of the lens.

- Only one filter may be attached.
- If you need a polarizing filter, use the Canon Circular Polarizing Filter PL-C B (58 mm).
- Detach the hood when adjusting the polarizing filter.

7 Close-up Lenses (sold separately)

Attaching a 250D or 500D (58 mm) Close-up Lens enables close-up photography. The magnification will be as follows.

- Close-up Lens 250D: 0.08x - 0.37x
- Close-up Lens 500D: 0.04x - 0.31x

 MF mode is recommended for accurate focusing.

8 Extension Tubes (sold separately)

You can attach extension tube EF12 II or EF25 II for magnified shots. The shooting distance and magnification are shown below.

| | | Focusing Distance Range (mm) | | Magnification (×) | |
|---------|------|------------------------------|---------------|-------------------|---------------|
| | | Close distance | Long distance | Close distance | Long distance |
| EF12 II | 18mm | 120 | 128 | 0.82 | 0.66 |
| | 55mm | 175 | 344 | 0.55 | 0.23 |
| EF25 II | 18mm | Incompatible | | | |
| | 55mm | 160 | 231 | 0.91 | 0.51 |

 MF mode is recommended for accurate focusing.

Specifications

| | |
|---------------------------------|---|
| Focal Length/Aperture | 18-55mm f/4-5.6 |
| Lens Construction | 10 groups, 12 elements |
| Minimum Aperture | f/22-32 |
| Angle of View | Diagonal: 74° 20' - 27° 50', Vertical: 45° 30' - 15° 40', Horizontal: 64° 30' - 23° 20' |
| Min. Focusing Distance | 0.25 m/0.82 ft. |
| Max. Magnification | 0.25x (at 55 mm) |
| Field of View | Approx. 148 x 228 – 59 x 89 mm/5.83 x 8.98 – 2.32 x 3.50 inch (at 0.25 m/0.82 ft.) |
| Filter Diameter | 58 mm |
| Max. Diameter and Length | 66.5 x 61.8 mm/2.62 x 2.43 inch |
| Weight | Approx. 215 g/7.6 oz. |
| Hood | EW-63C (sold separately) |
| Lens Cap | E-58 II |
| Case | LP1014 (sold separately) |

- Equivalent to 29-88 mm in the 35 mm film format.
- The lens length is measured from the mount surface to the front end of the lens. Add 24.2 mm when including the lens cap and dust cap.
- The size and weight listed are for the lens only, except as indicated.
- Extenders cannot be used with this lens.
- Aperture settings are specified on the camera. The camera automatically compensates for variations in the aperture setting when the camera is zoomed in or out.
- All data listed is measured according to Canon standards.
- Product specifications and appearance are subject to change without notice.

Only for European Union and EEA (Norway, Iceland and Liechtenstein)



This symbol indicates that this product is not to be disposed of with your household waste, according to the WEEE Directive (2012/19/EU) and national legislation. This product should be handed over to a designated collection point, e.g., on an authorized one-for-one basis when you buy a new similar product or to an authorized collection site for recycling waste electrical and electronic equipment (EEE). Improper handling of this type of waste could have a possible negative impact on the environment and human health due to potentially hazardous substances that are generally associated with EEE. At the same time, your

cooperation in the correct disposal of this product will contribute to the effective usage of natural resources. For more information about where you can drop off your waste equipment for recycling, please contact your local city office, waste authority, approved WEEE scheme or your household waste disposal service. For more information regarding return and recycling of WEEE products, please visit www.canon-europe.com/weee.

Canon