

QUASAR SCIENCE

Rainbow 2

LED Linear Light

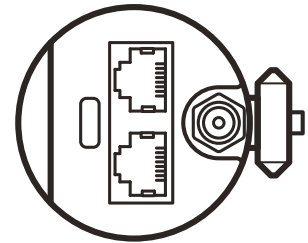
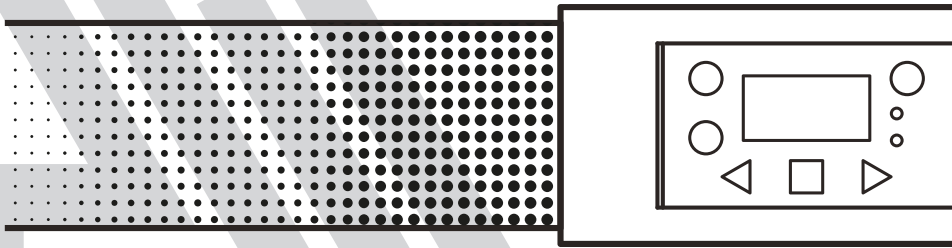

Quick Start Guide

Table of Contents

Copyright	3
Safety Information	4
Overview	6
R2 - What's in the Box	6
R2 - Overview	7
R2 Interface Layout	8
Button Shortcuts	9
Screen Information Layout	11
Mounting R2	14
Basic Specifications	15
Manual Mode	16
Getting Started	16
Status Lights	18
Power Options	25
Main Menu - Manual Mode	26
Config Menu	27
Pixel Layout & Grouping	29
Wired Control Menus	30
Wireless Control Menus	31
Lead/Follow Mode	32
Output Mode	33
Power On Mode	35
Effects (Manual Mode)	36
DMX	39
Warranty	50
Copyright	51

Copyright

Copyright © 2022

All rights reserved.

Original Instructions: English

All rights reserved throughout the world. No part of this publication may be stored in a retrieval system, transmitted, copied or reproduced in any way, including, but not limited to, photocopy, photograph, magnetic or other record without the prior agreement and permission in writing of Videndum Plc.

Disclaimer

The information contained in this publication is believed to be correct at the time of printing. Videndum Ltd reserves the right to make changes to the information or specifications without obligation to notify any person of such revision or changes. Changes will be incorporated in new versions of the publication. We are making every effort to ensure that our publications are updated on a regular basis to reflect changes to product specifications and features. Should this publication not contain information on the core functionality of your product, please let us know. You may be able to access the latest revision of this publication from our website. Videndum Production Solutions Ltd reserves the right to make changes to product design and functionality without notification.

Trademarks

All product trademarks and registered trademarks are the property of Videndum Plc.

All other trademarks and registered trademarks are the property of their respective companies.

Published by:

Videndum Production Solutions Ltd

Email: publications@videndum.com

Safety Information

Important information on the safe installation and operation of this product. Read this information before operating the product. For your personal safety, read these instructions. Do not operate the product if you do not understand how to use it safely. Save these instructions for future reference.

Warning Symbols Used in these Instructions

Important information on the safe installation and operation of this product. Read this information before operating the product. For your personal safety, read these instructions. Do not operate the product if you do not understand how to use it safely. Save these instructions for future reference.



WARNING

Where there is a risk of personal injury or injury to others, comments appear supported by the warning triangle symbol. Where there is a risk of damage to the product, associated equipment, process or surroundings, comments appear supported by the word 'Caution'.



DANGER

Where there is a risk of electric shock, comments appear supported by the hazardous voltage warning triangle.

Electrical Connection



DANGER

Risk of electric shock. Do not remove cover, no user servicable parts inside the product.



WARNING

Risk of electric shock. Always check cables for signs of damage. Damaged cables can cause personal injury and/or damage the equipment.



DANGER

Refer servicing to qualified service personnel.

Operation



WARNING

Special precautions and handling instructions are contained in this user guide and should be strictly adhered to for safe and reliable operation.



WARNING

Never use flammable or combustible materials and solvents around lights.



CAUTION

The product should not be used outside the operating temperature limits. Refer to the product technical specifications for the operating limits for the product.



WARNING

Protect the product from water, moisture and dust. The presence of electricity near water can be dangerous.



CAUTION

Do not directly look into the light, it can cause harm to your eyes.



CAUTION

Do not look at the LEDs with a magnifying glass or any other optical instrument that may concentrate the light output.

Maintenance



DANGER

The fitting of non-approved parts or accessories, or the carrying out of non-approved alterations or servicing can be dangerous and could affect the safety of the product. It may also invalidate the terms and conditions of the product warranty.



DANGER

Never attempt to service this light. Refer servicing to qualified service personnel.

Overview

R2 - WHAT'S IN THE BOX

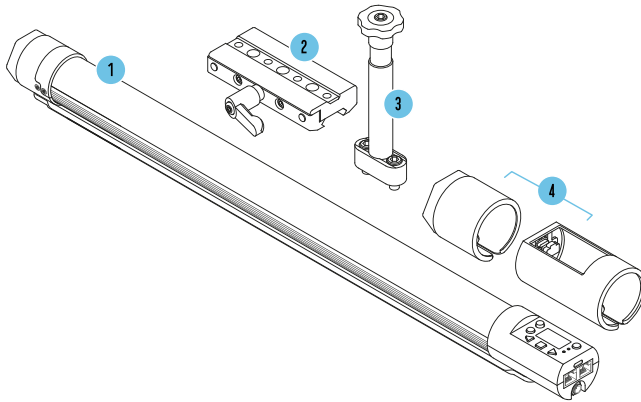

No.	Description	QTY
1	R2 LED Linear Lightwith Ossium Rail(Q25R2 shown)	1
2	QS Slider	1
3	QS Dual ScrewBaby Pin	1
4	Q-Boot Silicon Bumpers	2
N/A	8ft AC Power Cable	1
N/A	8ft DC Power Cable:P-TAP to 2.1mm Barrel	1
N/A	Quick Start Guide	1
N/A	Short Cut Guide	1
N/A	3/16 Hex Wrench	1

R2 - OVERVIEW

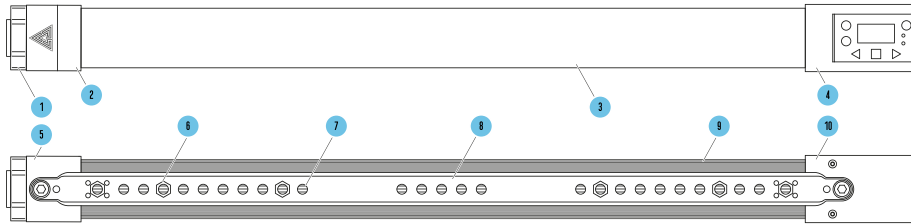

1	Power Side
2	Lens Hatch
3	Slim Diffuser
4	Control Side
5	End Cap
6	(White Hexagons)
7	Mounting Holes
8	Ossium Rail
9	Heat Sink
10	End Cap

*Q25R2 shown as reference

R2 INTERFACE LAYOUT

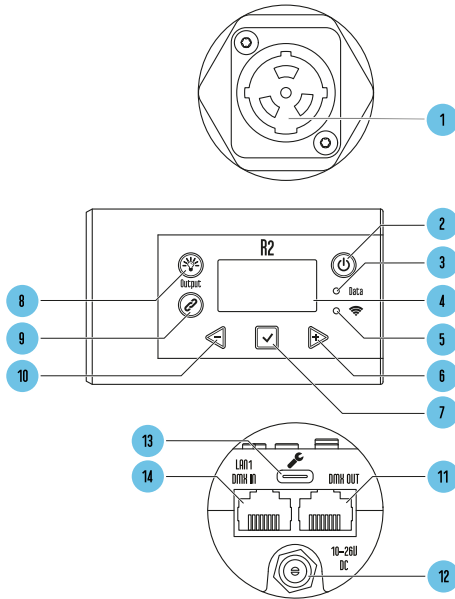









- | | |
|----|----------------------------------|
| 1 | AC IN Port |
| 2 | Power On / Off |
| 3 | “Data” Status Light |
| 4 | LED Screen |
| 5 | “Wireless” Status Light |
| 6 | “Right / +” Button |
| 7 | “Enter / Set” Button |
| 8 | “Output” Button |
| 9 | “Link” Button |
| 10 | “Left / -” Button |
| 11 | DMX OUT |
| 12 | DC IN Port: 2.1mm x 5.5mm
⊖ ⊕ |
| 13 | USB-C Update Port |
| 14 | LAN1 / DMX IN |

- Ⓞ **Power Button:** To turn the light on, press and hold for 1 second. To turn the light off, press and hold for 2 seconds. Double Tap the Power Button to Return to the Main Screen. When on the Main Screen, single tap the Power Button to get to the Sub Status Screen. To change the power on mode, to energize with to turn on when energized, without pressing the Power Button.
- Ⓞ **Output Button:** Toggle the button to enable/disable the lamp output in manual mode operation. Users can change the color, intensity or effect of the light without the changes affecting the environment before toggling the lamp back on. An Asterisk (*) appears in the top left corner of the screen whenever the Output Button is not allowing lamp output.
- Ⓞ **Link Button:** On CRMX: For RX, press and hold to unlink light. For TX, Single tap to send pairing signal. Double Tap to bring up Wireless Menu
- ◀ **Left / Minus Button:** Decrease a value or navigate Left.
- ▶ **Right / Plus Button:** Increase a value or navigate Right.
- ☑ **Enter / Save Button:** Enter selection, Save Value.
- 🔧 **Upgrade Port:** USB-C Port for performing software updates with a USB-C Thumb Drive.

BUTTON SHORTCUTS

- **Min / Max Value Jump:** On parameter menus such as Intensity, Color Temperatur, Saturation, Hue and Effects parameters.
 - While pressing and holding ▶ to increase the value, tapping ◀ will jump to the Next Value Range or Max Value.
 - While pressing and holding ◀ to decrease the value, tapping ▶ will jump to the Next Value Range or Minimum Value.
- **Output Mode:** Press ☑ and ▶ together for 2 seconds to change Output Modes from High to Normal to Low Output Mode. (Output Mode cannot be changed manually if the parameter is following data input i.e. DMX, sACN, ArtNet, etc).
- **Enable/Disable Status Lights:** Press and hold ☑ for 1 second to disable the Status LEDs on the fixture. Both Status LEDs will flash Red to indicate OFF. Press again for 1 second to enable, both lights will flash green to indicate ON.

- **Enable/Disable Wireless:** Press and hold  and  for 2 seconds to disable all Wireless Functions in Basic Routing (CRMX, WiFi and Bluetooth). If Wireless Settings are already disabled this button shortcut will set the Wireless Mode = Wireless DMX.
- **Reset to Default:** Press and hold  and  for 2 seconds to reset the light to Factory Default settings. (Does not clear CRMX link)
- **CRMX Linking:** Tap the  on your transmitter to pair the fixture's CRMX link.
- **CRMX UnLinking:** Press and hold  for 3 seconds to unpair a light that is linked to a Transmitter. If you turn off Wireless DMX in the menu without Unlinking, the CRMX LINK will be remember the next time you enable Wireless DMX for input.
- **Wireless Menu:** Double tap  to jump to the Wireless Mode Menu. (If using 0.9a or later: When in Advanced Routing this shortcut will bring you to the Routing you are using.)
- **Reset Bluetooth Connection:** When in a Bluetooth mode Hold  for 3 seconds to reset Bluetooth connection.
- **Return to Status Screen:** Double tap the Power Button  to return to the main Status Screen display.

SCREEN INFORMATION LAYOUT

The Main Status Screen Of The Light Will Display All The Primary Information For Working With The Light.



1	"Output" Button Toggle Sign
2	Number of Pixels Configured
3	Control Status
4	Control Mode (DMX, Art-Net, sACN, CRMX, Bluetooth, WiFi)
5	Profile and Number of Channels
6	Output Mode
7	Control Address

Output Button Indicator

Toggle the button to enable/disable lamp output for manual mode operation. **See Section:** [Output Enable Button \[33\]](#)

Number of Pixels

Shows the Number of Pixels selected in the Menu **See Section:** [Number of Pixels](#)

Control Mode

Displays the current Control Mode of the light. DMX, Art-Net, sACN, CRMX (Wireless DMX), Bluetooth, WiFi **See Section:** [Control](#)

Profile Number

Displays the DMX Profile and Number of Channels the DMX Profile occupies based on the number of pixels set. **See Section:** [DMX Profiles](#)

Output Mode

Displays HO=High Output, LO = Low Output, NO = Normal Output modes. **See Section:** [Output Mode \[33\]](#)

Control Address

Displays the DMX address or IP address of the Light - **See Section:** [DMX Address](#)

SubStatus Screens

While viewing the Main Status Screen, a single tap of the Power Button will bring up a Sub-Status Screens with additional information. Additional presses of enter will advance to the next screen.

1. **Color Status Screen** - Shows the color output settings of the light. This displays a live, spectral distribution chart from Pixel 1 of the Light. It also displays the Values of the light being produced based on the chosen DMX Profile: xy coordinates, RGB values, HSIC, etc.

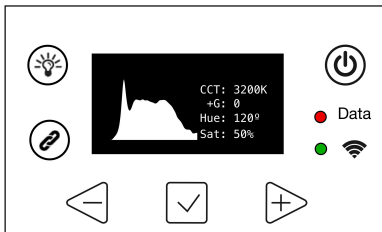

2. **Wired Network information (Wired Art-Net or sACN mode)** - When the light is set to receive Art-Net or sACN, it will display the IP and Subnet mask settings and universe of the current network protocol being received. When the light is set to receive DMX, it will display the DMX refresh rate and the current DMX status.
3. **Wireless Network information (WiFi mode)** - Displays the IP and Subnet mask settings and universe. In STA mode this screen will also display the SSID of the network the fixture has joined. In AP mode this screen will show the fixture is broadcasting the SSID.
4. **Firmware Status Screen** - Displays all of the software installed on the fixture: Fixture Firmware, Boot Loader version, WiFi Module, TimoTwo Module and the internal temperature of the fixture.

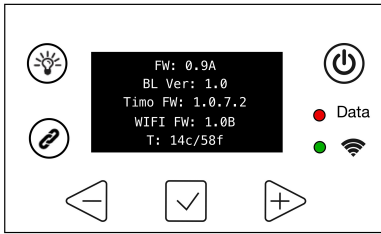

NOTE

The hardware status screen will display a **T** if the Timo module needs a firmware update



NOTE

The hardware status screen will display an **!** if the WiFi module needs a firmware update

5. **Fixture # Display** - As of [firmware release 0.7](#), if you turn on Fixture Numbers in the Config Menu they will display on this status screen. For details on how to setup visit [HERE](#)

MOUNTING R2

Option A	Option B	Option C	Option D
----------	----------	----------	----------

Mount Dual Screw Baby Pin directly to the light using 3/16 Hex wrench.

Mount Dual Screw Baby Pin to Ossium Rail Slider using 3/16 Hex wrench for added convenience and versatility.

Mount Rotator* using 5/32 hex wrench directly to the light.

Mount Rotator* using 5/32 hex wrench to Ossium Rail Slider for added convenience and versatility.

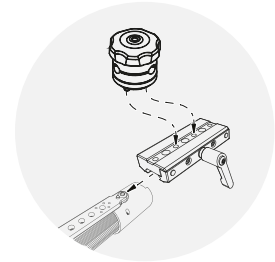
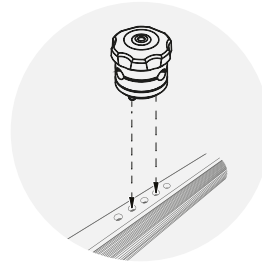
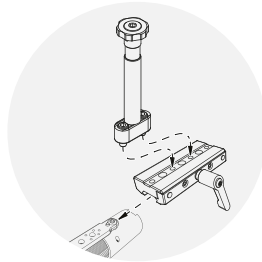
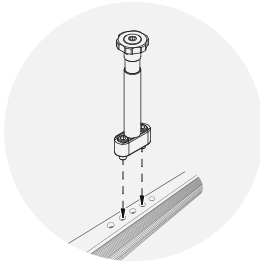

*Rotators and other Ossium Mounting accessories sold separately.



Basic Specifications

Model	Q25R2	Q50R2	Q100R2
Wattage	Max 25 watts	Max 50 watts	Max 100 watts
Weight	1.76 lbs (0.8 kg)	3.3 lbs (1.5 kg)	5.84 lbs (2.64 kg)
Dimensions	23 x 1.75 in (584.2 x 44.5 mm)	46.9 x 1.75 in (1161.7 x 44.5 mm)	90.86 x 1.75 in (2307.8 x 44.5 mm)
Power Consumption	120v = 0.25 amp 240v = 0.13 amp 12v = 2.50 amp 24v = 1.30 amp	120v = 0.45 amp 240v = 0.25 amp 12v = 4.50 amp 24v = 2.30 amp	120v = 0.90 amp 240v = 0.50 amp 24v = 4.80 amp

Manual Mode

GETTING STARTED

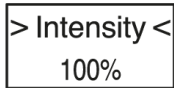

To Set The Intensity, Color Temp, +/- Green, Saturation And Hue:

1. Press  or  until desired function is shown on screen, and press  to select.

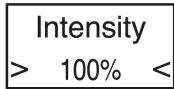

2. The selection carets "> <" will move from the "> **Function** <" to the "> **Value** <".



3. Press  or  to set the value. Press  to save.

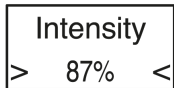

Rainbow 2

4. The selection carets "> <" will move from the "> Value <" back to the "> Function <".

> Intensity <
87%



5. For function items that have a submenu(s), **selection asterisks** "*" "*" will show instead of carets. Press ENTER to navigate functions in the submenus.

* Config *
Menu



Status Lights

The Status Lights of the RR and R2 light can be various colors to indicate connection Type/Status.

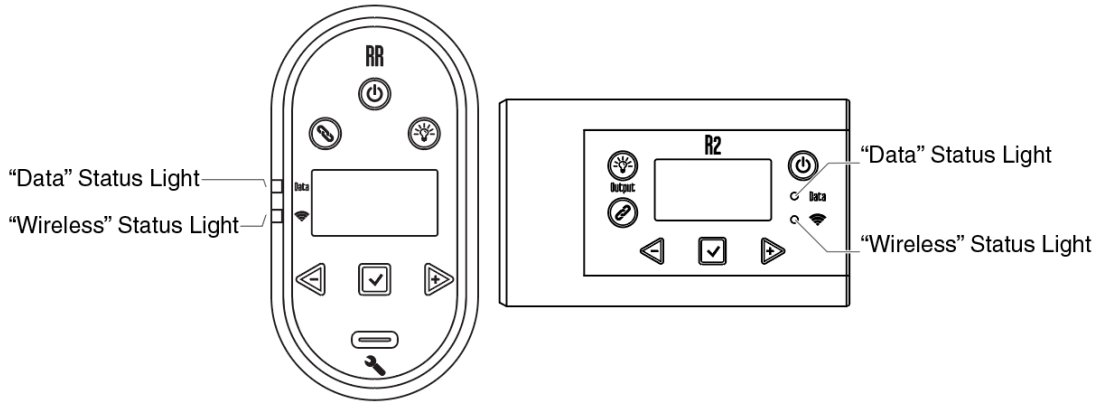

Status Light Colors

The **Status Lights** on the lights are color coded to show what Mode and connection the light is in. The color of the **Data Light** shows the Type of Data that the light is receiving. The color of the **Wireless Light** shows the light's Wireless Signal protocol. The combination of the 2 LEDs will show the status of the light.



NOTICE

Firmware 0.9 adds many new Status LED color combinations. All items listed in this article are unchanged when in Basic Routing mode. For the updated list of Status Light colors please see: [Updated Status LEDs for Advanced Routing](#)

Local

	Manual Mode - Data: Off / Wireless: Off Manual Mode
---	--

Lead / Follow - Wired



Wired Leader - Data: Green / Wireless: Off ([Lead/Follow Mode](#))



Wired Follower - Data: Cyan / Wireless: Off ([Lead/Follow Mode](#))

Lead / Follow - Wireless



Wireless Leader - Data: Green / Wireless Purple ([Lead/Follow Mode](#))



Wireless Follower - Data: Cyan / Wireless: Purple ([Lead/Follow Mode](#))

Wired



DMX Mode / Data Received - Data: Red / Wireless: Off ([DMX Mode](#))



Ethernet Mode / Data Received - Data: Yellow / Wireless: Off ([Wired Control: sACN](#) [Wired Control: Art-Net](#))



Node Mode - Data: Solid Orange ([Wired Control: sACN](#) [Wired Control: Art-Net](#))

Wireless



Wireless DMX - Data: Red / Wireless Green (Or the Universe-assigned color) [Wireless Control: CRMX / W-DMX](#)



WiFi Mode (Art-Net over WiFi) - Data: Yellow / Wireless: Magenta [Connecting the Blackout app with Art-Net over a Wi-Fi network](#)[Connecting Luminair Art-Net over Wifi Network](#)



WiFi Access Point Mode (Art-Net Over WiFi) - Data Yellow / Wireless Orange [Connecting the Blackout app with Art-Net over a Wi-Fi network](#)[Connecting Luminair Art-Net over Wifi Network](#)



Bluetooth Mode - Data: Blue / Wireless: Blue [Bluetooth Mode](#)



WiFi Network as Client - Data: Solid Magenta



NOTE

If the Status LEDs are disabled in the Config Menu, they will only be ON when the display is on, and turn off when the display screen turns off.

Universe Color for CRMX

When connected to a CRMX Transmitter that is able to send a Universe color, the Wireless Status light will be the same color as the Universe Color set on the transmitter. This color can be set using Lumenradio's CRMX Toolbox App with a compatible CRMX transmitter.

If the Transmitter has no color set, or it is not able to send a Universe Color, the wireless LED will be Green.

Status Light Blink Patterns

The **Data** and **Wireless Status Lights** can be various colors based on the connection type and status. Check that the light is in the correct wired or wireless mode and that Status lights are enabled in the Config menu.

Data Status Light



Data

Solid RED LED – DMX Data Being Received.



Data

No Light – No Data Received on wired input or Status Lights turned off.



Data

Yellow Blinking Data Light - Error with the data received from sACN or Art-Net input.

Wireless Status Light



Solid Green LED – Connected to Wireless DMX Device.



Slow Flashing Green – Light is paired with Wireless DMX Device and connected, but Transmitter is not receiving data.



Fast Flashing Green – Light is connecting to DMX Transmitter, or Light is paired with a Wireless DMX Device but the device is not found.



Solid Magenta LED - Lamp is connected to wireless network.



Fast Flashing Magenta - Light is connecting to a Wi-Fi Network.



Slow Flashing Magenta - Light has Wif-Fi network information saved but the router or AP is not found.



Alternate Flashing Magenta/Red - Light failed to connect to a Wi-Fi network (Wrong Password Error)



Solid Orange LED - Lamp is acting as a wireless access point



No Light – Light is Not Paired with Wireless Device, Wireless Mode -> Off or Status Lights turned off.



TIP

The Status Lights can be disabled from the Config Menu → Status LEDES → On/Off. When set to OFF they go off with the LCD screen.

Power Options

AC Power

The RR and R2 lights can be powered from AC power through a True 1 Power connector. The Control side endcap has a power button. It accepts Universal Power from 110 to 240 volts for all power systems throughout the world.

DC Power

The Rainbow can be powered from DC power through a 2.1mm x 5.5mm locking barrel connector. It accepts 10 volts to 30 volts DC. *(a non-locking 2.1mm barrel may also work but will not be secured)*

Battery Usage

When running the lights on batteries the following chart can be used to estimate battery life. Many factors contribute to the length of time a battery will last, like age of battery, intensity of fixtures and more. The following should be used as a guide only. At 24 volts in the same capacity expect double the runtime. Please ensure the battery/cable can handle the amperage.

Battery Size:		3200 mAh	6000 mAh	7200 mAh	10,000 mAh
Voltage:		12v	12v	12v	12v
Q25R2 Runtime:	1.9 amps	60 minutes	90 minutes	160 minutes	240 minutes
Q50R2 / RR50 Runtime:	3.8 amps	30 minutes	60 minutes	90 minutes	120 minutes
Q100R2 / RR100 Runtime:	7.6 amps	-	-	30 minutes	60 minutes



NOTE

When on battery power and the battery is below operating voltage the Rainbow will begin to flash.

Main Menu - Manual Mode

> Intensity	0 to 100% by 1%
> Color Temp	1,750K to 10,000K by 1 Just Notable Difference
> +/- Green	-G 100 to G 0 to +100 G -- Ex. +G 25 = 1/4 +Green, -G 50 = 1/2 -Green (Magenta)
> Saturation	0 to 100% by 1%
> Hue	0° to 360°
> CT Preset	3,200K - 4,300K - 5,600K - 6,500K(D65) - 7,500K(D75) - 10,000K - 2,000K - 2,500K - 3,000K
> Color Preset	Red - Orange - Yellow - Green - Cyan - Blue - Violet - Magenta
> Effects	Rainbow - Short Circuit - Paparazzi - Strobe - Fire - Emergency Lights - Demo
> Config	Light Settings

Config Menu

This menu layout is for firmware 0.9a Basic Routing. You can find information on previous releases in the online Help Center: <https://quasarscience.com/support>

> Routing	Choose the input signal routing option (Basic/Advanced)
> DMX Channel	Set the DMX Channel.
> Number of Pixels	Set the number of pixel groups in the light to control in groups.
> Profile	Set the DMX profile for the light.
> Wired Mode	Select the Wired data options to control the light. (DMX, Art-Net, sACN)
> Ethernet Settings	Set the IP Mode, Subnet, Input/Output Universe
> Wireless Mode	Select the Wireless data options. (CRMX, Bluetooth, WiFi)
> WiFi Settings	Set the WiFi Network, AP/Client Mode and WiFi Password
> Lead / Follow	Set Lead/Follow mode for the light.
> Output Mode	Set the light to Normal Output, High Output, or Low Output Mode.
> Power On Mode	With Button, turns on with Power Button. With Input, turns on when power is connected.
> Status Lights	Turns the status lights on/off for use on camera.
> Fixture # Labels	Enable/Disable the Fixture # view on the main LCD Screen in ####.## format.

-
- | | |
|---------------------------|---|
| > Lamp Hours | Displays the total hours the light has been powered on. Press Enter to See LED Hours. |
| > Update Firmware | Set the light into Firmware Update mode (<i>Boot Loader mode</i>). |
| > Firmware | Displays the firmware version on the light. |
| > Reset to Default | Sets the light back to all its default values. |
-

Pixel Layout & Grouping

> Number of Pixels

- 1, 2, 5, 10 - Available grouping options for the Q25R2's 10 individually controllable pixels.
- 1, 2, 3, 4, 6, 8, 12, 24 - Available grouping options for the Q50R2's 24 individually controllable pixels.
- 1, 2, 3, 4, 6, 8, 12, 16, 24, 48 - Available grouping options for the Q100R2's 48 individually controllable pixels.

When choosing DMX profiles, each **Parameter Channel Group** are repeated per pixel.

- When a Q100R2 is set to 1 Pixel for an example, it will control the entire light as 1 pixel and require 1 set of DMX Data to control it.
- When a Q100R2 is set to 48 Pixels for an example, it will control the light as 48 pixels and require 48 sets of DMX Data to control it.

The Layout of the pixels start from the "Gaffer's Left" when looking at the light projected towards the Gafer, with the controls on the right side.

Q25R2

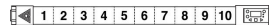

Q50R2

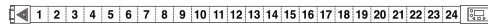

Q100R2



Wired Control Menus

These options are for firmware 0.9A. You can find information on previous releases in the online Help Center: <https://quasarscience.com/support>

> Wired Mode	Choose DMX512, Art-Net or sACN for wired control the light.
> Ethernet Settings	Set the IP Add mode, IP Address, Subnet, IN/Out Universe when using ethernet protocols.
> View IP Address	Show the IP address automatically received through DHCP or the Static IP address set.
> IP Address Mode	Set the IP Address Mode to Static or DHCP.
> DHCP (Auto)	Allow the light to obtain the IP address from the router or DHCP server automatically.
> Static	Manually set the fixture's IP address on the network.
> Save DHCP as Static	Save the info received from a DHCP server to the fixture's Static IP settings (IP, Subnet, Gateway). This changes the IP Add Mode to Static.
> IP Address, Subnet Mask, Gateway	Enter the IP address, Subnet mask, and Gateway.
> Input Universe	Set the Universe for the light.
> Output Universe	When using an Advanced Routing mode, you can set the output universe independently of the input universe.

Wireless Control Menus

These options are for firmware 0.9A. You can find information on previous releases in the online Help Center: <https://quasarscience.com/support>

- > **Wireless Mode** Set the Wireless input protocol (CRMX, WiFi or Bluetooth)

- > **CRMX** Our Wireless DMX is Lumenradio's CRMX protocol. When the fixture is used as a Receiver, Press and Hold  for 3 seconds to clear the previous link. Tap the Link button on your transmitter to pair with the fixture.

- > **Bluetooth** Enable the light to connect over Bluetooth.

- > **WiFi** Allows the fixture to receive Art-Net over WiFi and be controlled by WiFi devices (i.e iPad/Android tablets).

- > **WiFi Settings** Choose Client or AP mode. Client mode for connecting the fixture to an existing SSID, or it can become an Access Point and host up to (4) client connections.

- > **Off** Turns off all Wireless functionality.

- > **WiFi Reset** Forgets the currently connected SSID and password when in Client Mode.



TIP

Double Tap  to jump directly to the Wireless Mode menu.

See the full online Manual for detailed descriptions of CRMX and WiFi settings in Advanced Modes.

Lead/Follow Mode

Lead/Follow mode allows one light to control many lights at once. The **Lead** transmits color and intensity data (wired or wirelessly) to the **Followers**. When the **Lead** changes levels the **Followers** will change as well. This also applies to on board FX.

To use **Lead/Follow** mode go to **Config Menu → Lead/Follow**. Set the leader to **Lead** and set all of the followers to **Follow 1** to match the leader. **Follow 2-8** are used with effects to do the same effect with different timings. This will run the same effects, intensities and levels which will be spread across the Follow fixtures based on Follow 2-8.

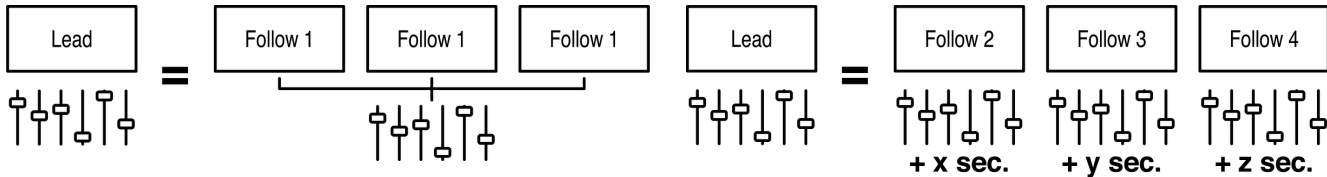

For wired **Lead/Follow**, plug a CAT5 cable from the **DMX OUT** port of the Leader to the Input of the Follower. You can daisy chain Followers to create an array controlled from the Lead fixture. The **Data** light should be illuminated on all the followers.

To use Lead/Follow wirelessly, set the **Wireless Mode** on all fixtures to “**CRMX**”, set your 1st fixture to Lead and the fixtures you wish to control to Follow 1-8. If Followers do not auto-LINK over CRMX, press and hold  for 3 seconds to unpair a Follower from any previous link.

Next tap  on the leader to pair the fixtures. On all of the Followers the Wireless Status LED should begin flashing and then remain solid. For more information please see the online manual and help articles.



NOTE

Lead/Follow is for manual operation only and cannot be used with DMX.

Output Mode

The RR and R2 lights can operate between three Output modes
The current Output mode is shown in the lower right of the main display.

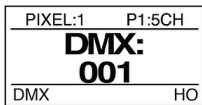

HO = High Output

NO = Normal Output

LO = Low Output

High Output: High operating temperatures but gives maximum light output. Use this mode with proper ventilation/cooling. This is the default setting.

Normal Output: Normal operating temperatures, standard light output.

Low Output: Gives maximum resolution in the low-end dimming of the light. Maximum power is about 25% of High Output.



NOTE

If you are working in the 0%-25% of the light's output when in HIGH OUTPUT MODE, switch to Normal or Low output to get even better performance and cooler operating temperatures..

The Output mode of the fixture can be set several different ways:

- Can be set in the Config Menu during initial setup
- Can be set using RDM
- Can be controlled with DMX profiles that include the Output Mode parameter (i.e. profiles 31-52). *DMX control takes priority over the Config Menu setting.*



TIP

Button Shortcut: Press ENTER + RIGHT ARROW together to change the Output Mode

See Section: [Output Mode Channels](#)

Power On Mode

Power On Mode is used to tell the light how it should turn on. It can be set to “with Input” or “with Button”. This setting is found in the Config Menu.

When set to “**with Button**”, after connecting the light to a power source the **Power Button** must be pressed to turn on the fixture.

When set to “**with Input**,” the light will turn on when power is applied, bypassing the need for the power button. In a Studio setting this is the preferred method to have the light turn on and is the default behavior.

Effects (Manual Mode)

Main Menu

Effect	Result
Rainbow	Scrolls through the Hue range from 0° at full saturation
Short Circuit	Light is on with random bursts of turning off
Paparazzi	Light is off with random flashes of turning on
Strobe	Rhythmic flashes on
Fire	A fire flicker effect
Emergency Lights	Flashing lights of various colors
Demo	Scrolls through the Hue Wheel and all Effects

Effects Parameters

Item	Result
Effect	Choose effect
Intensity	Set Intensity of effect
Color Temp	Set base Color Temp (CCT)
+/- Green	Set +/- green of the color temp
Saturation	Saturate the effect
Hue	Set the hue 0° - 360°
Rate	0-200% for the speed of the effect 100% is normal speed

EFFECT CONTROLS (MANUAL MODE)

Fire

Item	Result
Rate	0-200% for the speed of the effect 100% is normal speed
Maximum	Highest intensity level of effect
Minimum	Lowest intensity level of effect
Weight	Low, Centered, High
Preset	+/-400K Color at 2400K, 3200K, 4000K, 5600K

Emergency Light Submenu

Item	Result
Pattern	Single, Double, Triple, Quad
Color Presets	R&B, B&B, R&32, R&56, B&32, B&56, R&B&32, R&B&56
Color 1 & 2	Red, Orange, Yellow, Green, Blue, Magenta, 2000K, 3200K, 4000K, 5600K, 6000K

DMX

DMX Profiles for the lights come in two types: 1.) Basic DMX Profiles that include HSI, RGB and CCT modes. 2.) FX Profiles that have additional channels to trigger the built in FX.

DMX PROFILES & PIXEL PATCHING

DMX Profiles (Basic)	P1-8	Different DMX channel arrangements to control the Parameters for your light (i.e. HSI, HSI, RGB&CCT).
	P13, 14	Direct control of the 5 available colors channels; Red, Green, Blue, 2000K, 6000K

When in multi-pixel modes and programming the light's **pixels**, each Pixel acts as its own single "light" unit called a **Parameter Channel Group (PCG)**. Each **PCG** contains a set of DMX channels defined by the selected **DMX Profile** to control a given pixel.

DMX Profiles (FX)	P9-12	Control the basic parameters of the fixture and adds control of the built-in effects engine.
--------------------------	--------------	--

The FX Profiles are built upon the same profiles as the Basic Profiles. For example. Profile 9 is Profile 1 + FX Channels. When using DMX profiles with built in FX, an **FX Channel Group (FCG)** is added at the end of the patch. Changes in the **FCG** apply to the entire light.



TIP

Download the complete DMX Chart at [QuasarScience.com/Support](https://www.QuasarScience.com/Support)

DMX PIXEL PATCHING EXAMPLES

If the **Number of Pixels = 1**, the entire fixture functions as 1 Parameter Channel Group controlled by the currently selected DMX Profile. For example, DMX Profile = "1: HSIC Mode – 8 Bit" uses 5 Channels. Therefore that Parameter Channel Group has 5 DMX control channels:

1. Intensity (%)
2. Color Temp (K)
3. +/- Green (-G 100 to +G 100)
4. Hue (deg)
5. Saturation (%)

Example 1:

Number of Pixels = 4 with Profile 1: "HSIC Mode – 8 Bit" uses 5 Channels per PCG = 20 dmx channels in total.

PCG 1					PCG 2					PCG 3					PCG 4				
Int%	CCT	± G	Hue	Sat%	Int%	CCT	± G	Hue	Sat%	Int%	CCT	± G	Hue	Sat%	Int%	CCT	± G	Hue	Sat%
1	2	3	4	5	6	7	8	9	10	11	12	13	14	15	16	17	18	19	20

Example 2:

Number of Pixels = 2 with Profile 9: "HSIC+FX Mode – 8 Bit" uses 5 Channels per PCG + 3 Channels for FCG (FX Channel Group) = 13 dmx channels in total.

PCG 1					PCG 2					FCG		
Int%	CCT	± G	Hue	Sat%	Int%	CCT	± G	Hue	Sat%	FX	Size	Rate
1	2	3	4	5	6	7	8	9	10	11	12	13

DMX PROFILES (BASIC)

#	Name	Bit Depth	# of Channels- Per Pixel	Channel Description
1	HSIC	8 Bit	5	1: Intensity 2: Color Temp 3: +/- Green Control 4: Hue 5: Saturation
2	HSIC	16 Bit	8	1+2: Intensity 3: Color Temp 4: +/- Green Control 5+6: Hue 7+8: Saturation
3	HSI	8 Bit	3	1: Intensity 2: Hue 3: Saturation
4	XFade with +/-G	8 Bit	3	1: Intensity 2: Color Temp 3: +/- Green Control
5	XFade	8 Bit	2	1: Intensity 2: Color Temp
6	CCT & RGB	8 Bit	7	1: Intensity 2: Color Temp 3: +/- Green Control 4: Crossfade 5: Red 6: Green 7: Blue
7	CCT & RGB	16 Bit	9	1+2: Intensity 3: Color Temp 4: +/- Green Control 5+6: Crossfade 7: Red 8: Green 9: Blue
8	RGB	8 Bit	3	1: Red 2: Green 3: Blue
13	RGBTD	8 Bit	5	1: Red 2: Green 3: Blue 4:2000K 5: 6000K
14	RGBTD	16 Bit	10	1+2: Red 3+4: Green 5+6: Blue 7+8:2000K 9+10: 6000K

DMX PROFILES (BASIC) PARAMETERS

Available Parameters based on Profile

Parameter	DMX Value	Value
Intensity	0-255	0 - 100%
Color Temp	0-255	1,750K-10,000K
+/- Green		See Chart at below
Hue	0-255	0° - 360°
Saturation	0-255	0 - 100%
Crossfade	0-255	0 - 100%
Red	0-255	0 - 100%
Green	0-255	0 - 100%
Blue	0-255	0 - 100%

Rainbow 2

+/- Green Control DMX Values

DMX Value	%	Effect
0-10	0-4	No Effect
11-20	5-7	Full Minus Green
21-119	8-46	-99% to -1%
120-145	47-57	Neutral
146-244	58-96	1% to 99%
245-255	97-100	Full Plus Green

DMX PROFILES (FX)

#	Name	Bit Depth	# of ChPer Pixel	# of FXCh	Parameter Channel Group (Repeated per Pixel)	FX Channel Group (One Group per Light)
9	HSIC+FX	8 Bit	5	3	1: Intensity 2: Color Temp 3: +/- Green 4: Hue 5: Saturation	x+1: FX x+2: FX Rate x+3: FX Size
10	HSIC+FX	16 Bit	8	3	1+2: Intensity 3: Color Temp 4: +/- Green 5+6: Hue 7+8: Saturation	x = Total Number of Channels in Parameter Channel Groups
11	CCT & RGB+FX	8 Bit	7	3	1: Intensity 2: Color Temp 3: +/- Green 4: Crossfade 5: Red 6: Green 7: Blue	
12	CCT & RGB+FX	16 Bit	9	3	1+2: Intensity 3: Color Temp 4: +/- Green 5+6: Crossfade 7: Red 8: Green 9: Blue	

DMX PROFILES (FX) PARAMETERS

FX Selection

Effect	DMX Value	%
OFF	0-26	0-10
Rainbow	27-38	11-15
Short Circuit	39-51	16-20
Paparazzi	52-64	21-25
Strobe	65-77	26-30
Fire	78-90	31-35
Emergency Lights	91-102	36-40
Future Use	103-255	41-100

Effects Parameters

Item	Result
Effect	Choose effect
Intensity	Set intensity of effect
Color Temp	Set base color temp
+/- Green	Set +/- green of the color temp
Saturation	Saturate the effect
Hue	Set the hue
Rate	0-200% - Speed of the effect 100% - Normal speed
Size	Fire Effect: Set the +/- of the Intensity

Ex: Int 50%, FX Size 10 = 50-10, and 50+10. Result = 40-60 Fire

Emerg Light: Set the Blink Pattern

Certificates

EU DECLARATION OF CONFORMITY



Videndum Production Solutions Ltd. declares under our sole responsibility, supported by Videndum Production Solutions GmbH - our authorized representative, that the product detailed in this manual conforms with all relevant provisions of the following EU directives:

- Electromagnetic Compatibility Directive 2014/30/EU
- Restriction of Hazardous Substances Directive 2011/65/EU

A copy of the declaration is available on request. EU contact: Videndum Production Solutions GmbH, Parkring 29, 85748 Garching, Germany

UK DECLARATION OF CONFORMITY



Videndum Production Solutions Ltd. declares under our sole responsibility that the product detailed in this manual conforms with all relevant provisions of the following UK Regulations:

- The Electromagnetic Compatibility Regulations 2016
- The Restriction of the Use of Certain Hazardous Substances in Electrical and Electronic Equipment Regulations 2012

A copy of the declaration is available on request.

UK contact: Videndum Production Solutions Ltd, William Vinten Building, Easlea Road, Bury St. Edmunds, IP32 7BY

FCC COMPLIANCE STATEMENT



This device complies with Part 15 of the FCC Rules. Operation is subject to the following two conditions:

1. This device may not cause harmful interference.
2. This device must accept any interference received, including interference that may cause undesired operation.

Note: This equipment has been tested and found to comply with the limits for a Class B digital device, pursuant to Part 15 of the FCC Rules. These limits are designed to provide reasonable protection against harmful interference in a residential installation. This equipment generates, uses, and can radiate radio frequency energy and, if not installed and used in accordance with the instructions, may cause harmful interference to radio communications. However, there is no guarantee that interference will not occur in a particular installation. If this equipment does cause harmful interference to radio or television reception, which can be determined by turning the equipment off and on, the user is encouraged to try to correct the interference by one or more of the following measures:

- Reorient or relocate the receiving antenna.
- Increase the separation between the equipment and receiver.
- Connect the equipment into an outlet on a circuit different from that to which the receiver is connected.
- Consult the dealer or an experienced radio/television technician for help.

Modifications not expressly approved by the manufacturer could void the user's authority to operate the equipment under FCC rules.

ENVIRONMENTAL CONSIDERATIONS



European Union Waste of Electrical and Electronic Equipment (WEEE) Directive (2002/96/EC)

This symbol marked on the product or its packaging indicates that this product must not be disposed of with general household waste. In some countries or European Community regions separate collection systems have been set up to handle the recycling of electrical and electronic waste products. By ensuring this product is disposed of correctly, you will help prevent potentially negative consequences for the environment and human health. The recycling of materials helps conserve natural resources. Visit our website for information on how to safely dispose of this product and its packaging.

In countries outside the EU:

Dispose of this product at a collection point for the recycling of electrical and electronic equipment according to your local government regulations.

Pollution statement

This equipment is designed for operation in Pollution Degree 2 environments.

Warranty

In order for a product to be covered under Quasar Sciences warranty, the customer must provide proof of purchase. However, please note that this warranty is transferable.

3 Year warranty from date of purchase.

Customer must provide proof of purchase.

This warranty is transferable.

Quasar Science will pay for:

The replacement parts, repair and/or labor costs to correct defects in materials and workmanship.

Service must be provided by Quasar Science or an Authorized Quasar Science Service Center

Quasar Science will not pay for:

Damage resulting from accident, misuse or abuse. Acts of God. Any failure that occurs for any other reason than materials and workmanship. Any shipping or handling costs.

Disclaimer of implied warranties / limitations of remedies:

Implied warranties, including the extent applicable warranties of merchantability or fitness for a particular purpose are excluded to the extent legally permissible. Any implied warranties that may be imposed by law are limited to 3 years or the shortest period allowed by law. Some states, provinces or countries do not allow limitations or exclusions on how long an implied warranty of merchantability or fitness lasts, the above limitations or exclusions may not apply to you.

If this product fails to work as warranted, customer's sole and exclusive remedy shall be repair or replacement according to the terms of this limited warranty. Quasar Science does not assume any responsibility for incidental or consequential damages. This warranty gives you specific legal rights and you may also have other rights which vary from state to state, province to province or country to country.

Copyright

All rights reserved throughout the world. No part of this document may be stored in a retrieval system, transmitted, copied or reproduced in any way, including, but not limited to, photocopy, photograph, magnetic or other record without the prior agreement and permission in writing of Videndum plc.

DISCLAIMER

The information contained in this manual is believed to be correct at the time of printing. Videndum Production Solutions Inc. reserves the right to make the changes to the information or specifications without obligation to notify any person of such revisions or changes. Changes will be incorporated in new versions of the publication. We are making every effort to ensure that our manuals are updated on a regular basis to reflect changes to the product specifications and features. Should this manual not contain information on the core functionality of your product, please let us know. You may be able to access the latest revision of this manual from our website. Videndum Production Solutions Inc. reserves the right to make changes to product design and functionality without notification.

TRADEMARKS

All product trademarks and registered trademarks are the property of Videndum Plc. All other trademarks and registered trademarks are the property of the respective companies.

PUBLISHED BY:

Videndum Production Solutions Inc. Email: technical.publications@videndum.com

Copyright 2022 - Videndum Production Solutions Inc. All rights reserved

