

Canon

EOS R3



Advanced User Guide

These operating instructions are for the EOS R3 with firmware ver. 1.7.0 or later installed.

E

Contents

Introduction.	9
Package Contents.	10
Supplemental Information.	12
Compatible Accessories.	13
Instruction Manuals.	14
Quick Start Guide.	15
About This Guide.	19
Compatible Cards.	21
Safety Instructions.	22
Handling Precautions.	25
Part Names.	28
Software.	42
Preparation and Basic Operations.	46
Charging the Battery.	47
Inserting/Removing Batteries.	51
Inserting/Removing Cards.	54
Using the Screen.	61
Turning on the Power.	63
Attaching/Detaching RF Lenses.	66
Attaching/Detaching EF/EF-S Lenses.	70
Multi-Function Shoe.	74
Using the Viewfinder.	76
Using Eye Control.	80
Basic Operations.	97
Menu Operations and Settings.	115
Quick Control.	120
Touch-Screen Operation.	122
Shooting Mode.	124
Fv: Flexible-Priority AE.	125
P: Program AE.	128

Tv: Shutter-Priority AE	130
Av: Aperture-Priority AE	133
M: Manual Exposure	136
BULB: Long (Bulb) Exposures	139
Shooting and Recording	143
Still Photo Shooting	144
Tab Menus: Still Photo Shooting	146
Image Quality	151
Still Photo Cropping/Aspect Ratio	159
Auto Exposure Bracketing (AEB)	163
ISO Speed Settings for Still Photos	167
HDR PQ Settings	175
HDR Mode	177
Auto Lighting Optimizer	182
Highlight Tone Priority	184
Anti-Flicker Shooting	186
High-Frequency Anti-Flicker Shooting	188
Shooting with Speedlites	195
Flash Function Settings	199
White Balance	214
Custom White Balance	220
White Balance Correction	231
Color Space	235
Picture Style Selection	236
Picture Style Customization	240
Picture Style Registration	244
Clarity	247
Lens Aberration Correction	248
Long Exposure Noise Reduction	255
High ISO Speed Noise Reduction	257
Dust Delete Data Acquisition	259
Multiple Exposures	263
Focus Bracketing	273

Panning Assist.	280
Interval Timer Shooting.	282
Silent Shutter Function.	286
Shutter Mode.	287
Releasing Shutter without Card.	289
Image Stabilizer (IS Mode).	290
Customizing Quick Controls.	293
Shooting with the Touch Shutter.	297
Image Review.	299
High-Speed Display.	302
Metering Timer.	304
Display Simulation.	305
Optical Viewfinder Simulation.	307
Shooting Information Display.	309
Viewfinder Display Format.	323
Display Performance.	324
Auto Power Off Temperature.	326
Metering Mode Selection.	327
Manual Exposure Compensation.	331
Exposure Lock (AE Lock).	333
General Still Photo Shooting.	335
Movie Recording.	338
Tab Menus: Movie Recording.	339
Movie Recording.	343
Movie Recording Size.	358
High Frame Rate.	365
Movie Recording Format.	366
Movie Cropping.	368
Sound Recording.	369
HDR Movie Recording.	373
Canon Log Settings.	375
Time-Lapse Movies.	382
Movie Self-Timer.	396

Image Stabilizer (IS Mode)	397
Shutter Button Function for Movies	400
Zebra Settings	402
Time Code	405
Other Menu Functions	412
General Movie Recording Precautions	423
AF/Drive	426
Tab Menus: AF (Still Photos)	427
Tab Menus: AF (Movie Recording)	431
AF Operation	434
Movie Servo AF	438
Selecting the AF Area	441
Manual Focus	468
Registering People to Prioritize	475
Servo AF Characteristics	490
Customizing AF Functions	501
Selecting the Drive Mode	514
Using the Self-Timer	517
Remote Control Shooting	519
Playback	521
Tab Menus: Playback	523
Image Playback	526
Magnified Image Display	531
Index Display (Multiple-Image Display)	539
Voice Memo Recording and Playback	542
Movie Playback	548
Editing a Movie's First and Last Scenes	551
4K Movie Frame Grab	554
Playback on a TV Set	556
Protecting Images	558
Erasing Images	562
Rotating Still Photos	569

Changing Movie Orientation Information.	571
Rating Images.	573
Copying Images.	581
Print Ordering (DPOF).	589
RAW Image Processing.	594
Cloud RAW Image Processing.	603
Resizing JPEG/HEIF Images.	613
Cropping JPEG/HEIF Images.	615
Converting HEIF to JPEG.	618
Slide Show.	623
Setting Image Search Conditions.	626
Browsing Images with the Main Dial.	629
Browsing Images with the Rate+Quick Control Dial 1.	631
Switching the Main Dial and Quick Control Dial 2.	633
Rate/Voice Memo Button Function.	634
Customizing Playback Information Display.	636
Displaying the Highlight Alert.	640
AF Point Display.	641
Playback Grid.	642
Movie Play Count.	643
HDMI HDR Output.	645
Communication Functions.	646
Tab Menus: Communication Functions Tab.	647
Available Communication Functions.	649
Camera Connect Communication from Smartphones.	651
Wi-Fi Connections with a Computer Using EOS Utility.	688
Basic Communication Settings.	695
Image Transfer to FTP Servers.	734
Sending Images to a Web Service.	764
Remote Control (EOS Utility).	772
Controlling the Camera with Browser Remote.	789
Ending Connections or Reconnecting.	818
Airplane Mode.	822

Checking and Editing Network Settings.	823
Syncing Time Between Cameras.	848
Setting Up GPS Features.	855
Connecting to a Wireless Remote Control.	864
Reference.	868
Troubleshooting.	875
Save/Load Communication Settings on Card.	893
Resetting Communication Settings.	897
Set-up.	898
Tab Menus: Set-up.	899
Selecting Cards for Recording/Playback.	902
Folder Settings.	910
File Numbering.	914
File Naming.	919
Card Formatting.	922
Auto Rotate.	925
Adding Orientation Information to Movies.	927
Date/Time/Zone.	929
Language.	933
Video System.	934
Help.	935
Beeps.	938
Volume.	939
Headphones.	940
Power Saving.	942
Screen and Viewfinder Display.	944
Screen Brightness.	946
Viewfinder Brightness.	947
Screen and Viewfinder Color Tone.	948
Fine-Tuning Viewfinder Color Tone.	949
UI Magnification.	950
HDMI Resolution.	951
Touch Control.	952

Multi-Function Lock	953
Shutter at Shutdown.	954
Sensor Cleaning.	955
App Selection for USB Connections.	960
Resetting the Camera.	961
Custom Shooting Mode (C1-C3).	963
Save/Load Camera Settings on Card.	966
Battery Information.	969
Copyright Information.	971
System Status Display.	974
Other Information.	978
Custom Functions/My Menu.	979
Tab Menus: Custom Functions.	980
Custom Function Setting Items.	984
Tab Menus: My Menu.	1022
Registering My Menu.	1023
Reference.	1029
Importing Images to a Computer.	1030
Importing Images to a Smartphone.	1033
Using an Optional USB Power Adapter to Charge the Camera.	1034
Troubleshooting Guide.	1036
Error Codes.	1054
ISO Speed in Movie Recording.	1055
Information Display.	1056
Specifications.	1073
Trademarks and Licensing.	1096

Introduction

Before starting to shoot, be sure to read the following

To avoid shooting problems and accidents, first read the [Safety Instructions](#) and [Handling Precautions](#). Also read this Advanced User Guide carefully to ensure that you use the camera correctly.

Take some test shots, and understand about product liability

After shooting, play images back and check whether they have been properly recorded. If the camera or memory card is faulty and images cannot be recorded or transferred to a computer, Canon cannot be held liable for any loss or inconvenience caused.

Copyrights

Copyright laws in some countries prohibit the unauthorized use of images recorded with the camera (or music/images with music transferred to the memory card) for purposes other than personal enjoyment.

Also be aware that certain public performances, exhibitions, etc. may prohibit photography even for private enjoyment.

Connecting other devices

Use the included interface cable or a Canon cable when connecting the camera to a computer or other device. When connecting an interface cable, also use the included cable protector (🔒).

- [Package Contents](#)
- [Supplemental Information](#)
- [Compatible Accessories](#)
- [Instruction Manuals](#)
- [Quick Start Guide](#)
- [About This Guide](#)
- [Compatible Cards](#)
- [Safety Instructions](#)
- [Handling Precautions](#)
- [Part Names](#)
- [Software](#)

Package Contents

Before use, make sure the following items are included in the package. If anything is missing, contact your dealer.



Camera

(with body cap (Camera Cover R-F-5), battery compartment cap, and shoe cover)



Eyecup ER-h



Battery Pack LP-E19

(with protective cover)

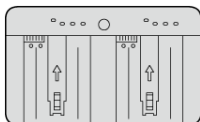

Battery Charger LC-E19

(with protective cover)

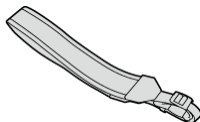

Strap



Interface Cable

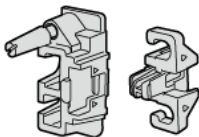

Cable Protector

- The camera does not come with a memory card (📷) or HDMI cable.
- Attach Eyecup ER-h to the viewfinder eyepiece.
- Be careful not to lose any of these items.
- No software CD-ROM is included. Software (📷) can be downloaded from the Canon website.

⚠ Caution

- The transmission rate when the included interface cable is used is equivalent to SuperSpeed USB (USB 3.1 Gen 1).

Supplemental Information

Refer to the following website for information on lenses compatible with camera features, and for supplemental information about the camera.

- <https://cam.start.canon/H001/>



Compatible Accessories

Check the following website for details on compatible accessories.

- <https://cam.start.canon/H002/>



Instruction Manuals



The included Instruction Manual provides basic camera instructions.

- **Advanced User Guide**

Complete instructions are provided in this Advanced User Guide. For the latest Advanced User Guide, refer to the following website.
<https://cam.start.canon/C010/>



- **Lens Instruction Manuals**

View or download from the following website.
<https://cam.start.canon/>



For software instruction manuals, see [Software Instruction Manuals](#).

 **Note**

- Select [: **Manual/software URL**] to display the QR code on the camera screen.

Quick Start Guide

1. Insert the battery (🔋).

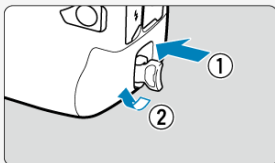

- Upon purchase, charge the battery to start using (🔋).

2. Insert the card (💳).

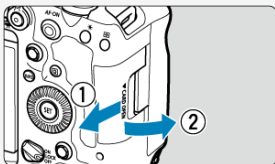

- You can insert two cards.

3. Attach the lens (🔍).

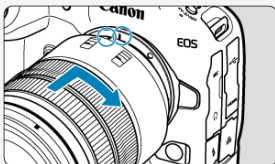

- Align the red mount index on the lens with the red mount index on the camera to attach the lens.

4. Set the lens's focus mode switch to < AF > (☑).

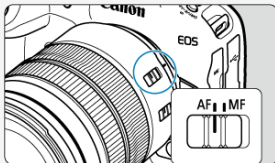

5. Set the power switch to < ON > (☑).

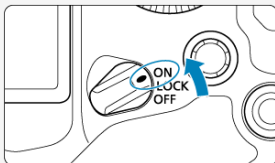

6. Flip out the screen (☑).

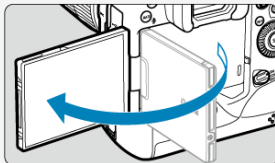

- When the date/time/zone setting screen is displayed, see [Date/Time/Zone](#).

7. Set the shooting mode to [P] (🔗).



- Press the <MODE> button, then turn the <🔧> dial to select [P].

8. Focus on the subject (🔗).



- A tracking frame [] appears over any face detected.
- Press the shutter button halfway, and the camera will focus on the subject.

9. Take the picture (🔗).

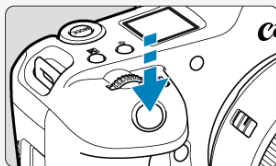

- Press the shutter button completely to take the picture.
- By default, the camera shoots in [📷] mode (🔗).

10. Review the picture.











- The image just captured will be displayed for approx. 2 sec. on the screen.
- To display the image again, press the < ▶ > button (📺).

About This Guide





 [Icons in This Guide](#)

 [Basic Assumptions for Operational Instructions and Sample Photos](#)

Icons in This Guide

	Indicates the Main dial.
	Indicates Quick control dial 1.
	Indicates Quick control dial 2.
	Indicates the Multi-controller.
	Indicates the Smart controller.
	Indicates the lens control ring.
	Indicates the Set button.
	Indicates the duration (in * seconds) of the operation for the button you pressed, as timed after you release the button.

- In addition to the above, the icons and symbols used on the camera's buttons and displayed on the screen are also used in this guide when discussing relevant operations and functionality.

	Links to pages with related topics.
	Warning to prevent shooting problems.
	Supplemental information.
	Tips or advice for better shooting.
	Troubleshooting advice.

Basic Assumptions for Operational Instructions and Sample Photos

- Before following any instructions, make sure the power switch is set to < ON > (🔘) and the Multi-function lock feature is off (🔘).
- It is assumed that all the menu settings and Custom Functions are set to their defaults.
- Illustrations in this guide show the camera with the RF24-105mm F4 L IS USM lens attached as an example.
- Sample photos in this guide are only for illustration.
- In references to using EF or EF-S lenses, it is assumed that a mount adapter is used.

Compatible Cards

The following cards can be used with the camera. **If the card is new or was previously formatted (initialized) by another camera or computer, format it with this camera** (🔗).

- **CFexpress cards**
* Type-B compatible
- **SD/SDHC/SDXC memory cards**
* UHS-II and UHS-I cards compatible



⚠ Caution

- You cannot use CFexpress cards with a capacity larger than 2TB.

Cards That Can Record Movies

When recording movies, use a CFexpress card that supports VPG400 or a card with ample performance (fast enough writing and reading speeds) for the movie recording quality (🔗).



In this manual, "CFexpress card" refers specifically to CFexpress cards, "SD card" refers to SD/SDHC/SDXC memory cards collectively, and "card" refers to all memory cards in general.

* **A card is not included.** Please purchase it separately.

Safety Instructions

Be sure to read these instructions in order to operate the product safely.
Follow these instructions to prevent injury or harm to the operator of the product or others.



WARNING:

Denotes the risk of serious injury or death.

- Keep the product out of the reach of young children.

A strap wrapped around a person's neck may result in strangulation.

The parts or provided items of cameras or accessories are dangerous if swallowed. If swallowed, seek immediate medical assistance.

The battery is dangerous if swallowed. If swallowed, seek immediate medical assistance.

- **PRODUCT CONTAINS BUTTON/COIN CELL BATTERY**

Button/coin cell batteries are hazardous and must be kept out of reach of children at all times, whether new or used.

These batteries can cause severe or fatal injuries in 2 hours or less if swallowed or placed inside any part of the body.

If it is suspected a button/coin cell battery has been swallowed or placed inside any part of the body, seek medical attention immediately.

- Use only power sources specified in this instruction manual for use with the product.
- Do not disassemble or modify the product.
- Do not expose the product to strong shocks or vibration.
- Do not touch any exposed internal parts.
- Stop using the product in any case of unusual circumstances such as the presence of smoke or a strange smell.
- Do not use organic solvents such as alcohol, benzine or paint thinner to clean the product.
- Do not get the product wet. Do not insert foreign objects or liquids into the product.
- Do not use the product where flammable gases may be present.

This may cause electric shock, explosion or fire.

- Do not leave a lens or a camera/camcorder with a lens attached, exposed without the lens cap attached.

The lens may concentrate the light and cause fire.

- Do not touch the product connected to a power outlet during lightning storms.

This may cause electric shock.

- Observe the following instructions when using commercially available batteries or provided battery packs.
 - Use batteries/battery packs only with their specified product.
 - Do not heat batteries/battery packs or expose them to fire.
 - Do not charge batteries/battery packs using non-authorized battery chargers.
 - Do not expose the terminals to dirt or let them come into contact with metallic pins or other metal objects.
 - Do not use leaking batteries/battery packs.
 - When disposing of batteries/battery packs, insulate the terminals with tape or other means.

This may cause electric shock, explosion or fire.

If a battery/battery pack leaks and the material contacts your skin or clothing, flush the exposed area thoroughly with running water. In case of eye contact, flush thoroughly with copious amounts of clean running water and seek immediate medical assistance.

- Observe the following instructions when using a battery charger or AC adapter.
 - Periodically remove any dust buildup from the power plug and power outlet using a dry cloth.
 - Do not plug in or unplug the product with wet hands.
 - Do not use the product if the power plug is not fully inserted into the power outlet.
 - Do not expose the power plug and terminals to dirt or let them come into contact with metallic pins or other metal objects.
 - Do not touch the battery charger or AC adapter connected to a power outlet during lightning storms.
- Do not place heavy objects on the power cord. Do not damage, break or modify the power cord.
- Do not wrap the product in cloth or other materials when in use or shortly after use when the product is still warm in temperature.
- Do not unplug the product by pulling the power cord.
- Do not leave the product connected to a power source for long periods of time.
- Do not charge batteries/battery packs at temperatures outside the range of 5 - 40 °C (41 - 104 °F).

This may cause electric shock, explosion or fire.

- Do not allow the product to maintain contact with the same area of skin for extended periods of time during use.

This may result in low-temperature contact burns, including skin redness and blistering, even if the product does not feel hot. The use of a tripod or similar equipment is recommended when using the product in hot places and for people with circulation problems or less sensitive skin.

- Follow any indications to turn off the product in places where its use is forbidden.

Not doing so may cause other equipment to malfunction due to the effect of electromagnetic waves and even result in accidents.

- Do not leave batteries near pets.

Pets biting a battery could cause leakage, overheating, or explosion, resulting in product damage or fire.



CAUTION:

Follow the cautions below. Otherwise physical injury or property damage may result.

- Do not fire the flash near the eyes.

It may hurt the eyes.

- Do not look at the screen or through the viewfinder for prolonged periods of time.

This may induce symptoms similar to motion sickness. In such a case, stop using the product immediately and rest for a while before resuming use.

- Flash emits high temperatures when fired. Keep fingers, any other part of your body, and objects away from the flash unit while taking pictures.

This may cause burns or malfunction of the flash.

- Do not leave the product in places exposed to extremely high or low temperatures.

The product may become extremely hot/cold and cause burns or injury when touched.

- Strap is intended for use on the body only. Hanging the strap with any product attached on a hook or other object may damage the product. Also, do not shake the product or expose the product to strong impacts.

- Do not apply strong pressure on the lens or allow an object to hit it.

This may cause injury or damage to the product.

- Only mount the product on a tripod that is sufficiently sturdy.

- Do not carry the product when it is mounted on a tripod.

This may cause injury or may result in an accident.

- Do not touch any parts inside the product.

This may cause injury.

- If any abnormal skin reaction or irritation occurs during or following the use of this product, refrain from further use and get medical advice/attention.



- After movie recording or repeated continuous shooting over an extended period, **do not touch the screen storage compartment (A), which may be hot.** This may cause burns.

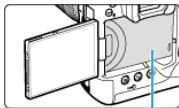

(A)

- Do not touch CFexpress cards immediately after shooting. Cards may be hot, which may cause burns. Cards are more likely to be hotter when [📷: Auto pwr off temp.] is set to [High]. Wait until the card has cooled down before removing it.

Handling Precautions

Camera care

- This camera is a precision instrument. Do not drop it or subject it to physical shock.
- The camera is not waterproof and cannot be used underwater.
- To maximize the camera's dust- and drip- resistance, keep the terminal cover, battery compartment cap, card slot cover, and all other covers firmly closed. Also attach the shoe cover to the multi-function shoe.
- This camera is designed to be dust- and drip- resistant, in order to help prevent sand, dust, dirt, or water that falls on it unexpectedly from getting inside, but it is impossible to prevent dirt, dust, water, or salt from getting inside at all. As far as possible, do not allow dirt, dust, water, or salt to get on the camera.
- If water gets on the camera, wipe it off with a dry and clean cloth. If dirt, dust, or salt gets on the camera, wipe it off with a clean, well-wrung wet cloth.
- Using the camera in dusty or dirty locations may lead to damage.
- Cleaning the camera after use is recommended. Allowing dirt, dust, water, or salt to remain on the camera may cause a malfunction.
- If you accidentally drop the camera into water or are concerned that moisture (water), dirt, dust, or salt may have gotten inside it, promptly consult the nearest Canon Service Center.
- Never leave the camera near anything having a strong magnetic field such as a magnet or electric motor. Also, avoid using or leaving the camera near anything emitting strong radio waves, such as a large antenna. Strong magnetic fields can cause camera malfunction or destroy image data.
- Do not leave the camera in excessive heat, such as in a car in direct sunlight. High temperatures can cause the camera to malfunction.
- The camera contains precision electronic circuitry. Never attempt to disassemble the camera yourself.
- Do not block shutter curtain operation with your finger or other objects. Doing so may cause a malfunction.
- Only use a commercially available blower to blow away dust on the lens, viewfinder, or other parts. Do not use cleaners that contain organic solvents to clean the camera body or lens. For stubborn dirt, take the camera to the nearest Canon Service Center.
- Do not touch the camera's electrical contacts with your fingers. This is to prevent the contacts from corroding. Corroded contacts can cause camera malfunction.
- If the camera is suddenly brought in from the cold into a warm room, condensation may form on the camera and internal parts. To prevent condensation, first put the camera in a sealed plastic bag and let it adjust to the warmer temperature before taking it out of the bag.
- If condensation forms on the camera, to avoid damage, do not use the camera or remove the lens, card, or battery. Turn the camera off and wait until the moisture has fully evaporated before resuming use. Even after the camera is completely dry, if it is still internally cold, do not remove the lens, card, or battery until the camera has adjusted to the ambient temperature.
- If the camera will not be used for an extended period, remove the battery and store the camera in a cool, dry, well-ventilated location. Even while the camera is in storage, press the shutter button a few times once in a while to check that the camera is still working.

- Avoid storing the camera where there are chemicals that result in rust and corrosion such as in a chemical lab.
- If the camera has not been used for an extended period, test all its functions before using it. If you have not used the camera for some time or if there is an important shoot such as a foreign trip coming up, have the camera checked by your nearest Canon Service Center or check the camera yourself and make sure it is working properly.
- The camera may become hot after repeated continuous shooting or still photo/movie shooting over an extended period. This is not a malfunction.
- If there is a bright light source inside or outside the image area, ghosting may occur.
- When shooting with backlighting, keep the sun sufficiently away from the angle of view. Always keep intense light sources such as the sun, lasers, and other intense artificial light sources out of the image area and not near it. Concentrated intense light may cause smoke or damage the image sensor or other internal components.
- Attach the lens cap to prevent direct sunlight and other light from entering the lens when you are not shooting.

Screen and viewfinder, LCD panel

- Although the screen and viewfinder are manufactured with very high precision technology with over 99.99% effective pixels, 0.01% or fewer of the pixels may be dead, and there may also be spots of black, red, or other colors. This is not a malfunction. They do not affect the images recorded.
- If the screen is left on for a prolonged period, screen burn-in may occur where you see remnants of what was displayed. However, this is only temporary and will disappear when the camera is left unused for a few days.
- The screen display may seem slightly slow in low temperatures or may look black in high temperatures. It will return to normal at room temperature.

Cards

To protect the card and its recorded data, note the following:

- Do not drop, bend, or wet the card. Do not subject it to excessive force, physical shock, or vibration.
- Keep dust and foreign material out of the card opening.
- Do not touch the card's electronic contacts with your fingers or anything metallic.
- Do not affix any stickers, etc. on the card.
- Do not store or use the card near anything that has a strong magnetic field, such as a television, speakers, or magnets. Also avoid places prone to having static electricity.
- Do not leave the card in direct sunlight or near a heat source.
- Store the card in a case.
- Do not store the card in hot, dusty, or humid locations.
- Cards may become hot after long sessions of repeated continuous shooting or still photo shooting/movie recording. This is not a malfunction.

Lens

- After detaching the lens from the camera, put down the lens with the rear end up and attach the rear lens cap to avoid scratching the lens surface and electrical contacts (1).

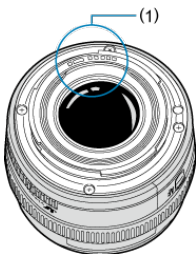

Smudges on the image sensor

Besides dust entering the camera from outside, in rare cases, lubricant from the camera's internal parts may adhere to the front of the sensor. If smudges are visible on images, have the sensor cleaned by a nearest Canon Service Center.

Part Names





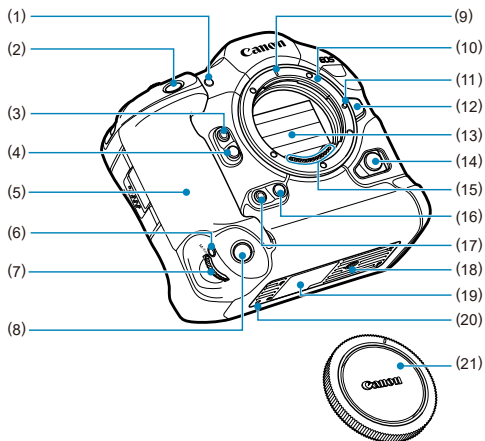



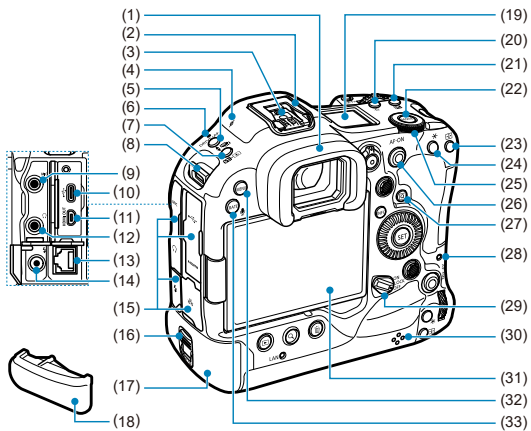



[Attaching the Strap](#)

[Using the Cable Protector](#)









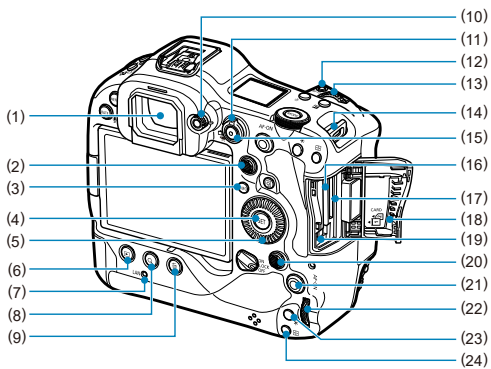

(1)	Self-timer lamp/AF-assist beam
(2)	Shutter button
(3)	Multi-function button 2 (M-Fn 2)
(4)	Depth-of-field preview button
(5)	Grip
(6)	< M-Fn > Vertical-grip Multi-function button
(7)	<  > Vertical-grip Main dial
(8)	Vertical-grip shutter button
(9)	RF lens mount index
(10)	Lens mount
(11)	Lens lock pin
(12)	Lens release button
(13)	Shutter curtain/Image sensor
(14)	Remote control terminal
(15)	Contacts
(16)	Vertical-grip depth-of-field preview button
(17)	Vertical-grip Multi-function button 2 (M-Fn 2)
(18)	Tripod socket
(19)	Serial number (body number)
(20)	Accessory positioning hole
(21)	Body cap



(1)	Eyecup
(2)	Multi-function shoe
(3)	Flash sync contacts
(4)	<  > Focal plane mark
(5)	< DRIVE • AF > Drive mode/AF operation selection button
(6)	Microphone
(7)	<  > Flash exposure compensation/metering mode selection button
(8)	Strap mount
(9)	< MIC > External microphone IN terminal
(10)	<  > Digital terminal
(11)	< HDMI OUT > HDMI micro OUT terminal
(12)	<  > Headphone terminal
(13)	<  > Ethernet RJ-45 terminal
(14)	<  > PC terminal
(15)	Terminal cover
(16)	Battery release handle
(17)	Battery
(18)	Battery compartment cap
(19)	LCD panel
(20)	<  > LCD panel info switching/illumination button
(21)	<  > Exposure compensation/aperture value setting button
(22)	< MODE > Mode button
(23)	<  > AF point selection button
(24)	<  > AE lock button
(25)	<  > Quick control dial 2
(26)	< AF-ON > AF start button/Smart controller
(27)	<  > Quick Control button
(28)	Access lamp
(29)	Power/multi-function lock switch
(30)	Speaker
(31)	Screen
(32)	< MENU > Menu button
(33)	< RATE /  > Rating/voice memo button



(1)	Viewfinder eyepiece
(2)	< * > Multi-controller (can also be pressed straight in)
(3)	< INFO > Info button
(4)	<  > Set button
(5)	<  > Quick control dial 1
(6)	<  > Playback button
(7)	< LAN > Network lamp
(8)	< Q > Magnify/reduce button
(9)	<  > Erase button
(10)	Dioptric adjustment knob
(11)	<  > Still photo shooting/<  > movie recording switch
(12)	< M-Fn > Multi-function button
(13)	<  > Main dial
(14)	Strap mount
(15)	Movie shooting button
(16)	Card slot 1
(17)	Card slot 2
(18)	Card slot cover
(19)	Card 1 eject button
(20)	< * > Vertical-grip Multi-controller (can also be pressed straight in)
(21)	< AF-ON > Vertical-grip AF start button/Smart controller
(22)	<  > Vertical-grip Quick control dial 2
(23)	< * > Vertical-grip AE lock button
(24)	<  > Vertical-grip AF point selection button

LCD panel information display



Information displayed varies depending on camera status. For icon details, see [Information Display](#).

Viewfinder information display

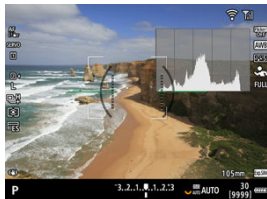

Information displayed varies depending on camera status.

Battery Pack LP-E19

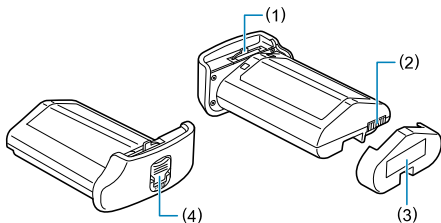

- | | |
|-----|------------------------|
| (1) | Battery lock lever |
| (2) | Contacts |
| (3) | Protective cover |
| (4) | Battery release handle |

Battery Charger LC-E19

Charger for Battery Pack LP-E19 (🔌).

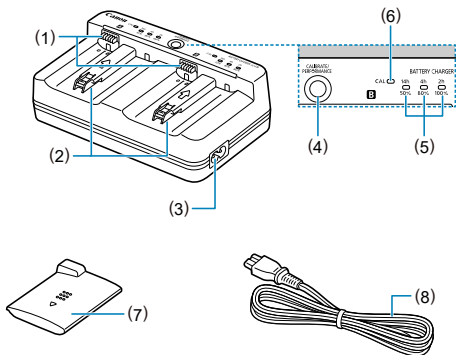

- | | |
|-----|---|
| (1) | Contacts |
| (2) | Battery slots |
| (3) | Power cord socket |
| (4) | Recharge performance check button/Calibration button |
| (5) | Charge lamp/Recharge performance check lamp/Discharge time lamp |
| (6) | Calibration (discharge) lamp |
| (7) | Protective cover (two included) |
| (8) | Power cord |

Attaching the Strap

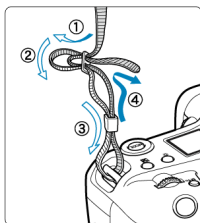

Pass the end of the strap through the strap mount from the bottom, then pass it through the strap buckle as shown. Pull the strap to take up any slack and make sure the strap will not loosen from the buckle.

Using the Cable Protector

- When connecting the camera to a computer, **use the included interface cable or a Canon cable.**
- Use a commercially available HDMI cable when connecting the camera to a monitor or other display device.
- **When connecting an interface cable, use the included cable protector.** Using the cable protector helps prevent accidental disconnection and terminal damage.

Preparation

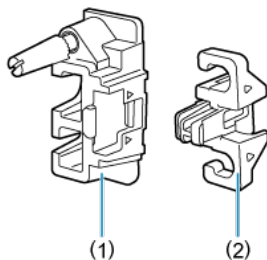

The cable protector consists of the protector (1) and a clamp (2).

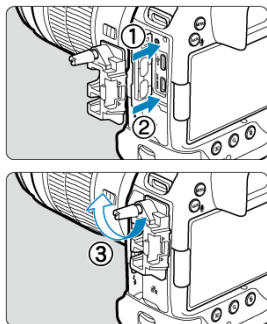

Attach the protector to the camera.

With the included interface cable and a slim commercially available HDMI cable

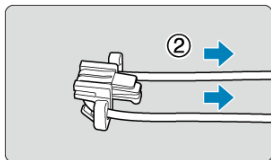
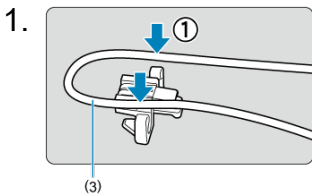

(3) Included interface cable

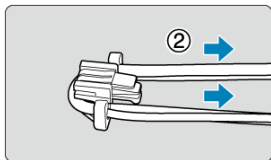
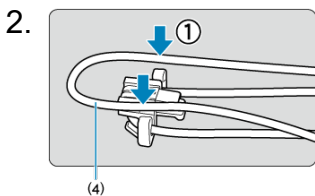

(4) Slim commercially available HDMI cable

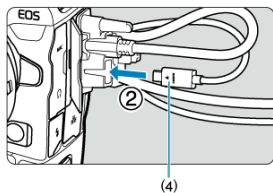
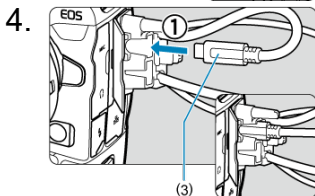
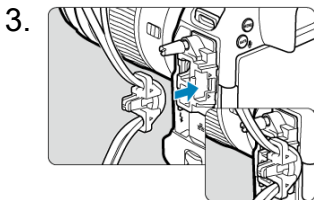

With an included or optional Canon interface cable and a thick commercially available HDMI cable

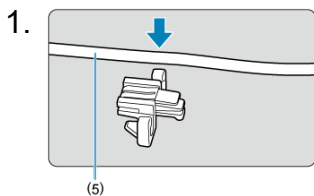

(5) Included or optional Canon interface cable

2.

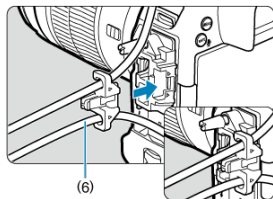

(6) Thick commercially available HDMI cable

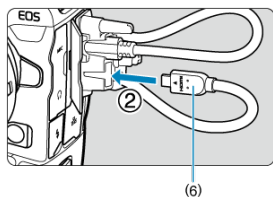
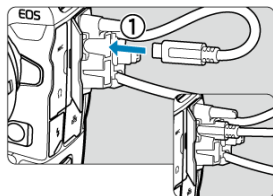

(6)

With only an optional Canon interface cable or a commercially available HDMI cable

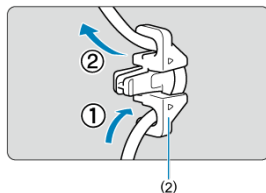

(2)

When using only an optional Canon interface cable or a thick/slim commercially available HDMI cable, pass the cable through the clamp (2) as shown before attaching the clamp to the cable protector.

 **Caution**

- Using the camera when an interface cable or HDMI cable is connected without the cable protector may damage the camera terminal. Make sure each cable is securely connected to the camera terminal.

Software

[☑ Software Overview](#)

[☑ Downloading and Installing EOS Software or Other Dedicated Software](#)

[☑ Software Instruction Manuals](#)

Software Overview

This section summarizes software used with EOS cameras. Note that downloading and installing the software requires an internet connection. The software cannot be downloaded or installed in environments without an internet connection.

EOS Utility

Enables you to transfer your captured still photos and movies from the camera to a connected computer, set various camera settings from the computer, and shoot remotely from the computer.

Digital Photo Professional

Software recommended for users who shoot RAW images. Enables image viewing, editing, printing, and more.

Picture Style Editor

Enables you to edit existing Picture Styles or create and save original Picture Style files. This software is for users who are familiar with image processing.

Downloading and Installing EOS Software or Other Dedicated Software

Always install the latest version of the software.

Update any previous versions that are installed by overwriting them with the latest version.

Caution

- Do not connect the camera to a computer before you install the software. The software will not be installed correctly.
- The software cannot be installed unless the computer is connected to the internet.
- Previous versions cannot display images from this camera correctly. Also, processing RAW images from this camera is not possible.

1. Download the software.

- Connect to the internet from a computer and access the following Canon website.

<https://cam.start.canon/>



- Select your country or region of residence and download the software.
- Depending on the software, you may need to enter the camera's serial number. The serial number is on the bottom of the camera.
- Decompress it on the computer.

- **For Windows**

Click the displayed installer file to start the installer.

- **For macOS**

A dmg file will be created and displayed. Follow the steps below to startup the installer.

1. Double-click the dmg file.

- A drive icon and installer file will appear on the desktop. If the installer file does not appear, double-click the drive icon to display it.

2. Double-click the installer file.

- The installer starts.

2. Follow the on-screen instructions to install the software.

Check the following website for software instruction manuals.

- <https://cam.start.canon/>



Preparation and Basic Operations

This chapter describes preparatory steps before you start shooting and the basic camera operations.

- [Charging the Battery](#)
- [Inserting/Removing Batteries](#)
- [Inserting/Removing Cards](#)
- [Using the Screen](#)
- [Turning on the Power](#)
- [Attaching/Detaching RF Lenses](#)
- [Attaching/Detaching EF/EF-S Lenses](#)
- [Multi-Function Shoe](#)
- [Using the Viewfinder](#)
- [Using Eye Control](#)
- [Basic Operations](#)
- [Menu Operations and Settings](#)
- [Quick Control](#)
- [Touch-Screen Operation](#)

Charging the Battery

1. Connect and plug in the battery charger.

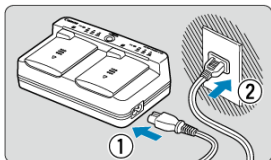

- Connect the power cord to the charger and plug the other end into a power outlet.
- All indicator lamps are off when no batteries are loaded.

2. Remove the protective cover.

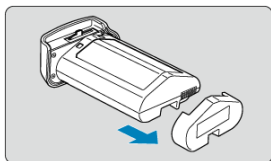
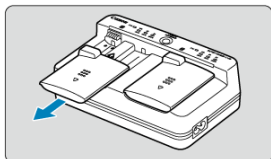

- Remove the included protective covers from the charger and battery.

3. Charge the battery.

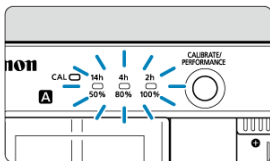
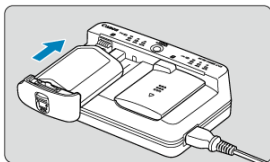

- Slide the battery in (in the opposite direction from protective cover removal) and make sure it is securely attached to the charger.
 - You can load a battery into either slot **A** or slot **B**.
 - Charging begins automatically, and the charge lamp blinks or lights up in green.
 - **Charging is finished when all three charge lamps (50%/80%/100%) are lit in green.**
-
- **Charging a depleted battery takes approx. 2 hr. and 50 min. at room temperature (23°C/73°F).** The time required to charge the battery will vary greatly depending on the ambient temperature and the battery's remaining capacity.
 - For safety, charging in low temperatures (5–10°C/41–50°F) takes longer (up to approx. 5 hr.).

Caution

- Use Battery Charger LC-E19 to charge Battery Pack LP-E19 (both included). This battery cannot be charged with Battery Charger LC-E4N/LC-E4.
- Depending on the condition of the battery, charging to 100% capacity may not be possible.

Note

- If you load two batteries, they are charged one after another in the order you load them.

- **Upon purchase, the battery is not fully charged.**
Charge the battery before use.
- **Charge the battery on the day before or on the day it is to be used.**
Charged batteries gradually lose their charge, even when they are not used.
- **After charging the battery, remove it and disconnect the charger from the power outlet.**
When not using the battery or charger, reattach the included protective covers.
- **Use the battery in an ambient temperature range of 0–45°C/32–113°F.**
For optimal battery performance, use batteries where the ambient temperature is 10–30°C/50–86°F. Lower temperatures may temporarily lower battery performance and reduce battery life.
- **When not using the camera, remove the battery.**
If the battery is left in the camera for a prolonged period, a small amount of power current will keep being released, resulting in excess discharge and shorter battery life. Store the battery with the protective cover attached. Storing the battery when it is fully charged may lower the battery performance.
- **The battery charger can also be used in foreign countries.**
The battery charger is compatible with a 100 V AC to 240 V AC 50/60 Hz power source. If necessary, attach a commercially available plug adapter for the respective country or region. To avoid damage, do not connect to portable voltage transformers.
- **Check battery recharge performance, as needed.**
Press the charger's < PERFORMANCE > button during charging to check battery recharge performance, as indicated by how many of the three lamps are lit in green.
 - ● ●: Battery's recharge performance is good.
 - ● ○: Battery's recharge performance is slightly degraded.
 - ○ ○: Purchasing a new battery is recommended.
- **If the battery becomes exhausted quickly even after having been fully charged, the battery has reached the end of its service life.**
Check the battery's recharge performance (🔋) and purchase a new battery.

? The <CAL> lamp blinks.

- This display advises you to calibrate (discharge) the battery, which will enable accurate charging capacity determination and battery level display on the camera.
- When the <CAL> lamp blinks in green, calibration is recommended. To charge the battery at this time, wait approx. 10 sec., and charging will begin automatically.
- To perform calibration, press the <CALIBRATE> button while the <CAL> lamp is blinking in green. The <CAL> lamp now remains lit in green, and discharging begins.
- Charging begins automatically after discharging, but note that the more fully charged the battery is, the longer discharging will take. Estimated time required for discharging is indicated by the <14h>, <4h>, and <2h> lamp, with a blinking green <14h> lamp indicating a discharge time of approx. 4–16 hours.
- Calibration drains the remaining battery level, and after this, charging the battery will take approx. 2 hr. 50 min. To cancel calibration in progress and start charging, remove and reload the battery in the charger.

Caution

- Multiple cycles of charging and use without calibration may result in inaccurate battery level display (🔋).
- One battery can be charged while another is calibrated, but two batteries cannot be charged or calibrated at the same time.
- When performing calibration, consider using a battery that is nearly depleted. Calibrating and then charging Battery Pack LP-E19 when it is fully charged takes approx. 18 hr. 50 min.

? Only the <100%> lamp is lit immediately after a battery is loaded.

- Illumination of only the <100%> lamp in green immediately after charging begins indicates that the internal battery temperature is out of range. Charging begins automatically when the internal temperature returns to 5–40°C/41–104°F.
- With two batteries loaded, illumination of only the <100%> lamp in green on the side of the second battery indicates standby status.

? All three lamps are blinking.

- Charging is not possible when batteries other than Battery Pack LP-E19 are loaded in the charger. In this case, the three charge lamps and <CAL> lamp blink in green.
- If the three charge lamps blink in green consecutively during charging (with or without blinking of the <CAL> lamp in green), remove the battery and contact your dealer or the nearest Canon Service Center.
- If the three charge lamps blink during calibration, remove the battery and contact your dealer or the nearest Canon Service Center.

Inserting/Removing Batteries

[Insertion](#)

[Removal](#)

Insert a fully charged Battery Pack LP-E19 into the camera.

Insertion

1. Remove the battery compartment cap.

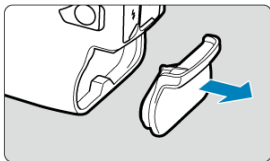

2. Insert the battery.

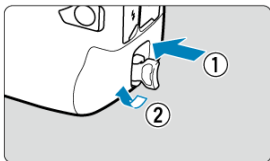

- Insert the battery firmly, all the way in, then turn the battery release handle as shown by the arrow.

Caution

- There may be a slight delay before the camera turns on when a battery is used in the camera for the first time.
- You cannot use batteries other than the Battery Pack LP-E19.

 **Note**

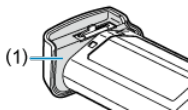

- Wipe away any dirt on the battery's water-repellent rubber lining (1) with a moistened cotton swab.

1. Turn the battery release handle and remove the battery.

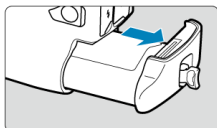
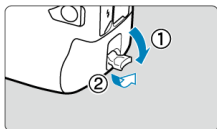

- Make sure the power switch is set to < OFF > (☑).
- Flip out the battery release handle, turn it as shown by the arrow, and remove the battery.
- To prevent short-circuits, always attach the included protective cover (☑) to the battery.
- When not using the camera, attach the battery compartment cap (☑).

Inserting/Removing Cards

[Insertion](#)

[Formatting the Card](#)

[Removal](#)

This camera accepts two cards. **Recording is possible as long as there is at least one card in the camera.**

With two cards inserted, you can select one card to record to, or you can record the same image to both cards at once ()

Caution

- **Make sure the SD card's write-protect switch (1) is set upward to enable writing and erasing.**

Insertion

1. Slide the cover to open it.

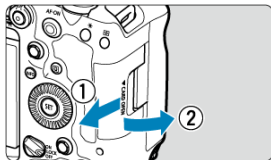

2. Insert the card.

Card 1 (CFexpress card)

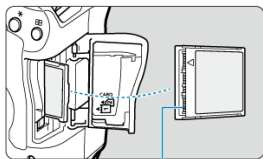

(2)

Card 2 (SD card)

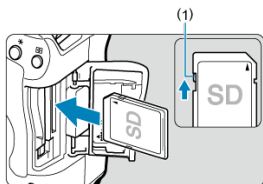

(1)

- The card in the rear card slot is [1] (CFexpress card), and the one in front of it is [2] (SD card).
- CFexpress card: With the card label facing you, insert the open side of the card (2) into the card slot. **Inserting cards the wrong way may damage the camera.**
- The card 1 eject button (gray) pops out.
- SD card: With the card label facing you, insert the card into the card slot until it clicks into place.

3. Close the cover.

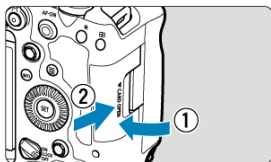

- Close the cover and slide it in the direction shown by the arrows until it snaps shut.

4. Set the power switch to < ON > (☑).

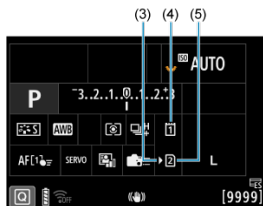
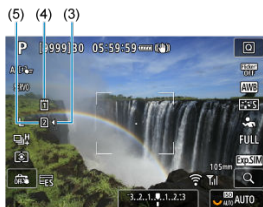

(3) Card selection icon

(4) Card 1 (CFexpress card)

(5) Card 2 (SD card)

- Icons representing loaded cards are shown on the shooting screen (☑) accessed by pressing the < INFO > button and on the Quick Control screen (☑). Cards labeled with [1] are selected for recording.

Formatting the Card

If the card is new or was previously formatted (initialized) by another camera or computer, format the card with this camera (🔗).

1. Open the cover.

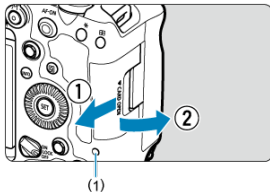

- Set the power switch to <OFF>.
- Check that the access lamp (1) is off, then open the cover.
- If [Saving...] is displayed on the screen, close the cover.

2. Remove the card.

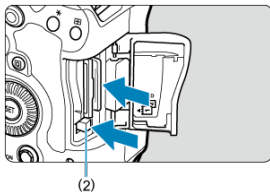



- CFexpress card: Press the card 1 eject button (2) to eject the card.
- SD card: Gently press the card in, then release it to eject it.
- Pull the card straight out, then close the cover.



Caution

Do not remove cards immediately after a red [] icon is displayed as you are shooting. Cards may be hot, due to high internal camera temperature. Set the power switch to <OFF> and stop shooting for a while before removing cards. Removing hot cards immediately after shooting may cause you to drop and damage them. Be careful when removing cards.

Note

- The number of shots available varies depending on remaining card capacity and settings such as image quality and ISO speed.
- Setting [: **Release shutter without card**] to [**Disable**] will prevent you from forgetting to insert a card ().

Caution

- **When the access lamp is lit or blinking, it indicates that images are being written to, read from, or erased from the card, or data is being transferred. Do not open the card slot cover during this time. To avoid corrupting image data or damaging cards or the camera, never do any of the following while the access lamp is lit or blinking.**
 - Removing the card.
 - Removing the battery.
 - Shaking or striking the camera.
 - **Unplugging or plugging in a power cord**
(when using optional household power outlet accessories).
- If the card already contains recorded images, the image number may not start from 0001 ().
- If a card-related error message is displayed on the screen, remove and reinsert the card. If the error persists, use a different card.
If you can transfer images on the card to a computer, transfer all the images and then format the card with the camera (). The card may then return to normal.
- Do not touch the card's contacts with your fingers or metal objects. Do not expose the contacts to dust or water. If smudges adhere to the contacts, contact failure may result.
- Multimedia cards (MMC) cannot be used. (Card error will be displayed.)
- Use of UHS-II microSDHC/SDXC cards with a microSD to SD adapter is not recommended.
When using UHS-II cards, use SDHC/SDXC cards.

Using the Screen

You can change the direction and angle of the screen.

1. Flip out the screen.

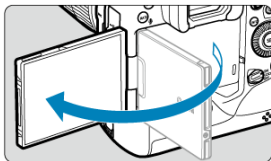

2. Rotate the screen.

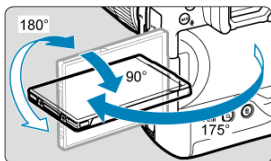

- When the screen is out, you can tilt it up or down or rotate it to face the subject.
- Indicated angles are only approximate.

3. Face it toward you.



- Normally, use the camera with the screen facing you.

 **Caution**

- Avoid forcing the screen into position as you rotate it, which puts undue pressure on the hinge.
- When a cable is connected to a camera terminal, the rotation angle range of the flipped-out screen will be limited.

 **Note**

- Keep the screen closed and facing the camera body when the camera is not in use. You can protect the screen.
- A mirror image (right/left reversed) of subjects is displayed when the screen faces subjects in front of the camera.

Turning on the Power

[Setting the Date, Time, and Time Zone](#)

[Changing the Interface Language](#)

[Automatic Sensor Cleaning](#)

[Battery Level Indicator](#)

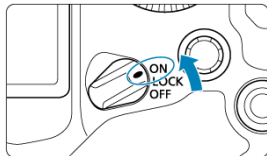

- **<ON>**
The camera turns on.
- **<LOCK>**
The camera turns on. Multi-function locking is engaged ()
- **<OFF>**
The camera is turned off and does not function. Set the power switch to this position when not using the camera.

Note

- If you set the power switch to **<OFF>** while an image is being recorded to the card, **[Saving...]** will be displayed and the power will turn off after the recording finishes.

Setting the Date, Time, and Time Zone

If you turn on the camera and the date/time/zone setting screen appears, see [Date/Time/Zone](#) to set the date/time/zone.

Changing the Interface Language

To change the interface language, see [Language](#).

Automatic Sensor Cleaning

- Whenever the power switch is set to **< OFF >**, the sensor is cleaned automatically (which may make a faint sound). During the sensor cleaning, the screen will display [🧹].
- Even during sensor cleaning, you can stop cleaning and shoot immediately by pressing the shutter button halfway (📷).
- If you repeatedly turn the power switch to **< ON / LOCK >** or **< OFF >** within a short time period, the [🧹] icon may not be displayed, but this does not indicate the camera is malfunctioning.

Battery Level Indicator

When the power switch is set to < ON >, the battery level will be indicated.

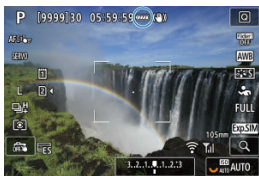

Display						
Level (%)	100-70	69-50	49-20	19-10	9-1	0

Note

- Doing any of the following will exhaust the battery faster:
 - Pressing the shutter button halfway for a prolonged period.
 - Activating the AF frequently without taking a picture.
 - Using the lens's Image Stabilizer.
 - Using Wi-Fi features.
 - Using the screen frequently.
 - Using accessories compatible with the multi-function shoe.
- The number of available shots may decrease depending on the actual shooting conditions.
- Lens operations are powered by the camera's battery. Certain lenses may exhaust the battery faster than others.
- See [: **Battery info.**] to check the battery status ().

Attaching/Detaching RF Lenses

 [Attaching a Lens](#)

 [Detaching a Lens](#)

Caution

- Do not look at the sun directly through any lens. Doing so may cause loss of vision.
- When attaching or detaching a lens, set the camera's power switch to < **OFF** >.
- If the front part (focusing ring) of the lens rotates during autofocusing, do not touch the rotating part.

Tips for avoiding smudges and dust

- When changing lenses, do it quickly in a place with minimal dust.
- When storing the camera without a lens attached, be sure to attach the body cap to the camera.
- Remove smudges and dust on the body cap before attaching it.

Attaching a Lens

1. Remove the caps.

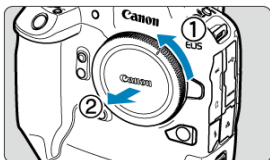
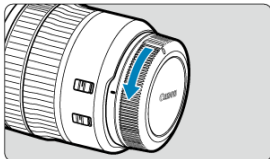

- Remove the rear lens cap and the body cap by turning them as shown by the arrows.

2. Attach the lens.

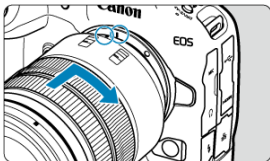

- Align the red mount index on the lens with the red mount index on the camera and turn the lens as shown by the arrow until it clicks in place.

3. Set the lens's focus mode switch to < AF >.

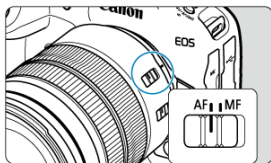

- < AF > stands for autofocus.
- < MF > stands for manual focus. Autofocus will not operate.



- For RF lenses without a focus mode switch, set to [AF] or [MF] in the camera menu, in [AF: Focus mode].

4. Remove the front lens cap.

Detaching a Lens

While pressing the lens release button, turn the lens as shown by the arrow.

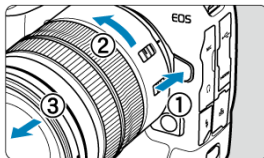

- Turn the lens until it stops, then detach it.
- Attach lens caps to the lens you removed.

Attaching/Detaching EF/EF-S Lenses

 [Attaching a Lens](#)

 [Detaching a Lens](#)

All EF and EF-S lenses can be used by attaching an optional Mount Adapter EF-EOS R.
The camera cannot be used with EF-M lenses.

Attaching a Lens

1. Remove the caps.

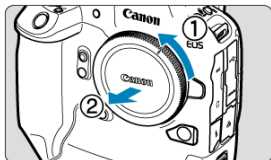
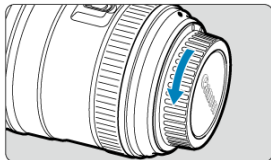

- Remove the rear lens cap and the body cap by turning them as shown by the arrows.

2. Attach the lens to the adapter.

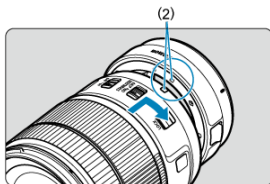
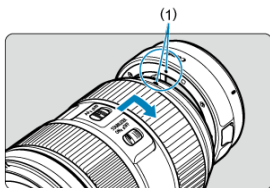

- Align the red or white mount index on the lens with the corresponding mount index on the adapter and turn the lens as shown by the arrow until it clicks into place.

(1) Red index

(2) White index

3. Attach the adapter to the camera.

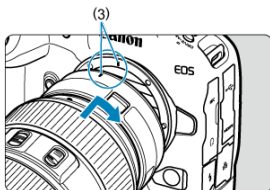

- Align the red mount indexes (3) on the adapter and camera and turn the lens as shown by the arrow until it clicks into place.

4. Set the lens's focus mode switch to < AF >.

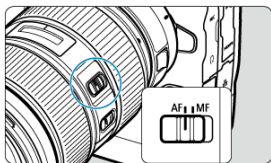

- < AF > stands for autofocus.
- < MF > stands for manual focus. Autofocus will not operate.

5. Remove the front lens cap.

Detaching a Lens

1. While pressing the lens release button, turn the adapter as shown by the arrow.

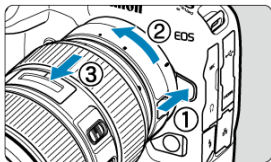

- Turn the lens until it stops, then detach it.

2. Detach the lens from the adapter.

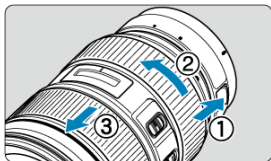

- Hold down the lens release lever on the adapter and turn the lens counterclockwise.
- Turn the lens until it stops, then detach it.
- Attach lens caps to the lens you removed.

Caution

- For lens precautions, see [Attaching/Detaching RF Lenses](#).

Multi-Function Shoe

[Using the Multi-Function Shoe](#)

The multi-function shoe is a hot shoe that supplies power to accessories and offers advanced communication functionality.

Using the Multi-Function Shoe

Removing the shoe cover

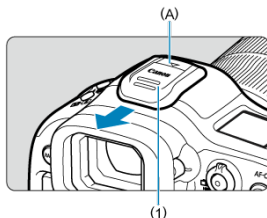

- Remove the shoe cover (1) by pressing the part labeled (A) in the figure as shown with your finger. After removal, keep the shoe cover in a convenient place to avoid losing it.

Attaching accessories

- When attaching accessories that communicate through contacts of the multi-function shoe, insert the accessory's mounting foot until it clicks into place, then slide the mounting foot locking lever to secure it. For details, refer to the accessory's Instruction Manual.
- The following accessories cannot be attached directly to the multi-function shoe.
 - Speedlite EL-1/600EXII-RT/600EX-RT/580EX II
 - Speedlite Transmitter ST-E3-RT (Ver. 2)/ST-E3-RT
 - Off-Camera Shoe Cord OC-E3
- To use the accessories listed above with the camera, you will need Multi-Function Shoe Adapter AD-E1, sold separately. For details, refer to the AD-E1 Instruction Manual.
- When attaching accessories other than these that are designed for regular hot shoes, insert the accessory's mounting foot all the way in, then slide the mounting foot locking lever to secure it. For details, refer to the accessory's Instruction Manual.
- Electronic Viewfinder EVF-DC2/EVF-DC1 cannot be attached to the multi-function shoe. Attempting to attach it by force may damage it or the multi-function shoe.

Attaching the shoe cover

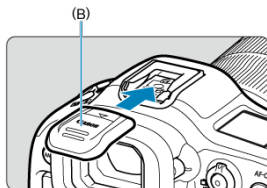

- After removing accessories from the multi-function shoe, reattach the shoe cover to protect the contacts from dust and water.
- Slide the shoe cover all the way in by pressing the part labeled (B) in the figure, as shown.

Caution

- Attach accessories correctly as described in [Attaching accessories](#). Loose attachment may cause the camera or accessories to malfunction, and accessories may fall off.
- Blow off any foreign material on the multi-function shoe with a commercially available blower or similar tool.
- Allow the multi-function shoe to dry before use if it gets wet.

Using the Viewfinder

 [Adjusting the Viewfinder](#)

 [Using Eyecup ER-hE \(Sold Separately\)](#)

Look through the viewfinder to activate it. You can also restrict display to either the screen or viewfinder ().

Adjusting the Viewfinder

1. Turn the dioptic adjustment knob.

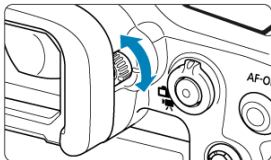

- Turn the knob left or right to make the viewfinder display look sharp.

Caution

- The viewfinder and screen cannot be activated at the same time.
- At some aspect ratios, black bars are displayed on the top and bottom or left and right edges of the screen. These areas are not recorded.

Using Eyecup ER-hE (Sold Separately)

Using Eyecup ER-hE may help improve eye control accuracy under intense light sources and enhance viewfinder visibility outdoors.

1. Detach the eyecup.

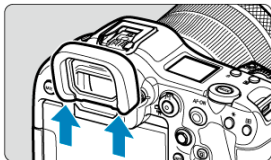

- Press in the position indicated.

2. Attach Eyecup ER-hE.

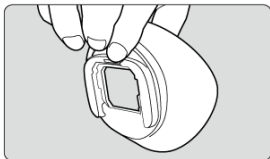
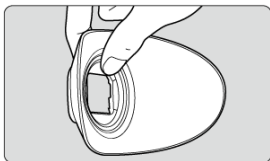

- Hold the eyecup as shown.

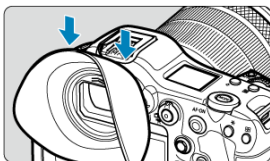

- Slide along the viewfinder eyepiece grooves to attach, and press all the way in.

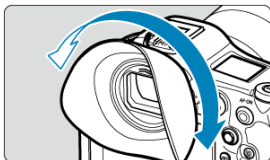

- You can rotate Eyecup ER-hE as necessary for adjustment. It clicks every 90° and can be rotated 360°.

3. To remove Eyecup ER-hE:

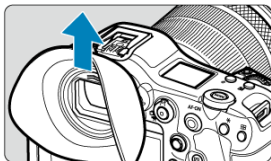

- Hold the eyecup as shown in step 2 and lift straight up.

Using Eye Control

- [☑ Performing Calibration](#)
- [☑ Using Eye Control for AF](#)
- [☑ Configuring Pointer Display](#)
- [☑ Managing Calibration Data](#)

You can control focusing by looking at AF points to select them in viewfinder shooting (eye control).

The process of registering characteristics of your line of sight for accurate detection of eye movement by the camera in viewfinder shooting is called calibration. Calibration enables higher eye control accuracy.

⚠ Caution

- Eye control is only available in still photo shooting.

Performing Calibration

After adjusting the viewfinder (👁), perform calibration under the same conditions as when you will shoot (such as with or without glasses or contact lenses). During calibration, keep your eye near the viewfinder.

1. Select [👁: Eye control (👁)].

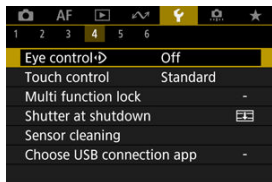

2. Select [Calibration (CAL)].

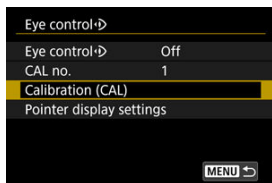

- Calibration results (calibration data) are saved to the current [CAL no.] number.

3. Select [Start].

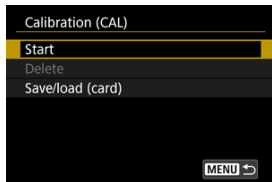

4. Look through the viewfinder.



- Holding the camera horizontally, look through the viewfinder so that the four corners of the screen appear evenly spaced.
- Press the <M-Fn> button.

5. Start calibration.

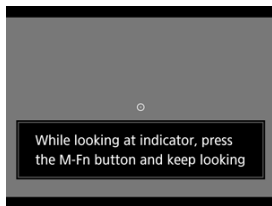

- Look at the indicator displayed and press the < M-Fn > button.
- Keep looking at the indicator without blinking until it disappears.
- This process is repeated for indicators at five positions (center, right, left, top, and bottom).

6. Perform calibration for vertical shooting.



- For higher eye control accuracy, select [**Refine**] and perform calibration for vertical shooting.
- Holding the camera vertically, look through the viewfinder so that the four corners of the screen appear evenly spaced, then repeat step 5.
- If you will also shoot vertically with the camera grip facing the other direction, perform calibration while holding the camera that way.
- To finish calibration after performing calibration only for horizontal shooting, go to step 7.

7. Exit calibration.

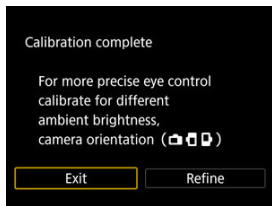

- Select [Exit]. Calibration results (calibration data) are saved to the calibration number shown in step 2.
- After calibration, look through the viewfinder and make sure the pointer moves in response. If the pointer does not seem to follow your gaze closely, perform calibration again.



Note

- Also read [General eye control precautions](#) and [Enhancing eye control accuracy](#).

Adding calibration data

To register calibration data for other users or eyewear conditions, select an available number to assign the data to from the numbers labeled with  on the [CAL no.] screen, then perform calibration.

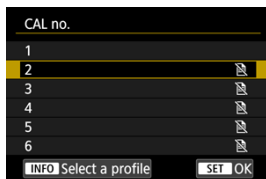

Using Eye Control for AF

Caution

- Always use eye control under the same eyewear conditions as when you performed calibration (such as with or without glasses or contact lenses).

Note

- Also read [General eye control precautions](#) and [Enhancing eye control accuracy](#).

Menu settings

1. Select [**Eye control**].

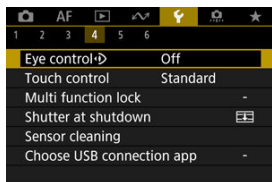

2. Select [**Eye control**].

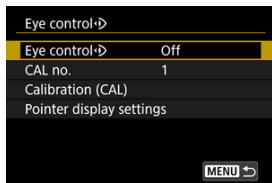

3. Select [On].

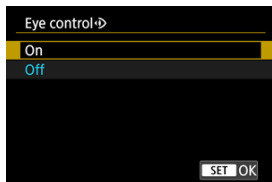

- You can enable switching between [**Eye control**] [**Enable**] and [**Disable**] from the Quick Control screen by customizing the Quick Control screen (🔗).

4. Select [CAL no.].

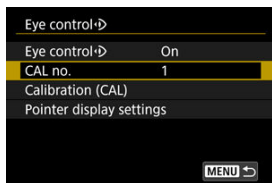

- Select a calibration number matching your eyewear conditions (such as with or without glasses).

5. Select calibration data to use.

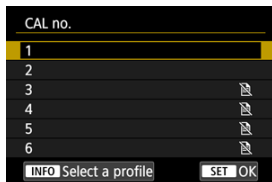

- Press <  >.

Operations in viewfinder shooting

1. Look at the subject.

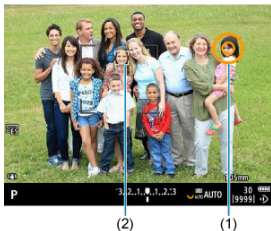

- A pointer (1) is displayed when you look through the viewfinder.
- With [**AF: Subject tracking**] set to [**On**], a tracking frame [] (2) is also displayed when subjects are detected.
- Look at the position where you wish to focus. To focus at the position of the tracking frame, look at the tracking frame.
- The pointer may stop moving unless the camera can follow your eye movement. If so, hold the camera away from your face for a moment, then look through the viewfinder again so that the four corners of the screen appear evenly spaced.

2. Confirm the subject to start focusing.



(3)

- Pressing the shutter button halfway confirms the subject to focus on.
- With **[AF: AF area]** set to **[Whole area AF]**, the camera focuses in the area near the pointer.
With the AF area set to an option other than **[Whole area AF]**, the camera focuses after moving the AF area to the pointer position.
- With **[AF: AF operation]** set to **[SERVO]**, the active AF point turns blue (3). The camera keeps tracking and focusing on the confirmed subject while you hold down the shutter button halfway. To stop tracking confirmed subjects, press the **< M-Fn2 >** button.
- With **[AF: AF operation]** set to **[ONE SHOT]**, the active AF point turns green. Pressing the shutter button halfway sets the focus on the current position.
- Press the shutter button completely to take the picture.

! Caution

- If the AF point does not move to your specified position after you confirm the subject, hold the camera away from your face, then look through the viewfinder again, or perform calibration again.

📷 Note

- You can assign eye control subject confirmation (**[Move AF point by eye control]**) and AF activation (**[Metering and AF start]**) to different buttons in **[.📷.: Customize buttons]**.
- With **[AF: AF area]** set to **[Whole area AF]**, the camera keeps tracking and focusing on confirmed subjects even when you release the shutter button after holding it down halfway. To stop tracking confirmed subjects, press the **< M-Fn2 >** button.

Using eye control to display the focus guide

By setting [**AF: Focus guide**] to [**On**], you can use eye control to display the focus guide for assistance when focusing manually.

1. Look at the subject.

- Look at the subject to focus on.

2. Press the shutter button halfway.



(1)

- The focus guide (1) is displayed where you are looking.
- For details on using the focus guide to focus, see [Focus Guide](#).



Note

- With [**AF: Subject tracking**] set to [**On**], a tracking frame [] is also displayed when subjects are detected.

General eye control precautions

- When multiple people will use eye control on the same camera, each person should select a different calibration number and perform calibration. Similarly, when the same person will use eye control with and without glasses or contact lenses, a different calibration number should be selected and calibration performed for each situation.
- When using Eyecup ER-h or an optional Eyecup ER-hE, select a different calibration number and perform calibration.
- Hold the eyecup securely against your face to block out sunlight or other light and keep your eye steady with the four corners of the screen appearing evenly spaced.
- Calibration or eye control may not be possible in the following cases.
 - When hard contact lenses are worn
 - When color contact lenses are worn
 - When special eyewear is worn, such as near-infrared blocking, mirrored, or bifocal glasses or sunglasses
 - When a mask is worn
 - When your eye is too far from the viewfinder
 - When your eye is too close to the viewfinder
 - When your eye is too misaligned with the viewfinder
 - When the viewfinder or your eyewear is dirty
 - When the viewfinder is fogged up
 - When your contact lenses are not fully in contact with your eyes
 - When sunlight is shining directly into the viewfinder
- Less responsive viewfinder display under low light may make eye control more difficult to use.

Enhancing eye control accuracy

The camera can learn about eye characteristics from the calibration data it collects.

- Eye control accuracy can be improved by repeating calibration under various levels of brightness (such as indoors, outdoors, during the day, and at night) for the same calibration number.
- To use eye control in each camera orientation, repeat calibration for the same calibration number with the camera held horizontally and vertically with the grip up and down.
- Keep the following tips in mind when performing calibration or using eye control.
 - Look into the viewfinder so that the four corners of the screen appear evenly spaced.
 - Look at the subject.
 - Avoid squinting.
 - Avoid blinking.
 - During calibration, look through the viewfinder as you do when shooting.
 - If you use glasses, wear them correctly.
 - In calibration outdoors, prevent sunlight from entering the viewfinder.
 - Use Eyecup ER-hE (sold separately, ).
 - Block out sunlight, to the extent possible, by keeping your face close to the viewfinder.
 - If it is difficult to perform calibration or eye control correctly, try keeping both eyes open as you look through the viewfinder.

If eye control seems inaccurate

- Eye control may be less accurate if your eye is off-center, relative to the viewfinder. Adjust how you are holding the camera to your face, so that the four corners of the screen appear evenly spaced.
- Eye control may be less accurate if you point the camera downward during calibration. Hold the camera straight when performing calibration.

Configuring Pointer Display

You can configure pointer display, including whether the pointer is visible or not.

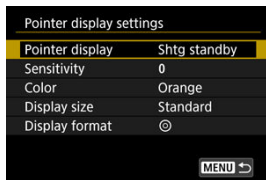

● Pointer display

Pointer visibility can be set to **[On]**, **[Shtg standby]**, or **[Off]**.

- Select **[Shtg standby]** to keep the pointer visible from when you look through the viewfinder until the moment you confirm the subject to focus on using eye control.
- The pointer may not always be displayed, depending on the state of the camera.
- In **[MF]** focus mode, setting **[AF: Focus guide]** to **[On]** makes the pointer visible.

● Sensitivity

Sensitivity of the pointer in response to eye movement is adjustable.

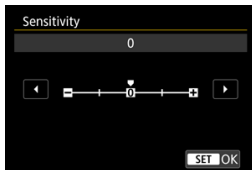

- Set toward the positive end to make the pointer responsive even to subtle eye movement.
- Set toward the negative end to make the pointer less responsive.

● Color

Choose **[Orange]**, **[Purple]**, or **[White]** as the pointer color.

● Display size

Choose **[Standard]** or **[Small]** as the pointer display size.

- **Display format**

Choose [☉] or [☺] as the style of pointer displayed.

Entering names

You can enter names to identify calibration data.

1. Select a calibration data number.

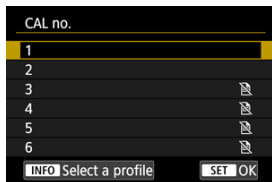

- Select the number and press the <INFO> button.

2. Enter text.

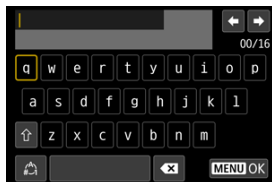

- Use the <⦿> or <☺> dial or <✱> to select a character, then press <SET> to enter it.
- By selecting [↑], you can change the input mode.
- To delete single characters, select [x] or press the <☒> button.
- When you are finished entering text, press the <MENU> button and select [OK].

Saving and loading calibration data

Registered calibration data can be saved to a card. You can also load calibration data from a card to use it.

1. Select [Calibration (CAL)].

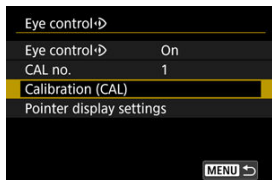

2. Select [Save/load (card)].

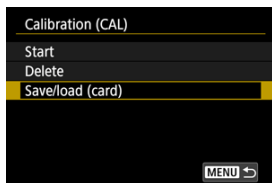

3. Select [Save to card].

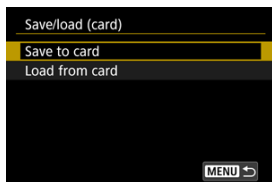

- Select [**Save to card**] to save all calibration data on the camera to the card.
- Select [**Load from card**] to overwrite calibration data on the camera with calibration data from the card.

Deleting calibration data

Eye control is less accurate if the same calibration number is used for calibration under different eyewear conditions (such as with or without glasses or contact lenses) or by multiple users. In this case, delete the calibration data and perform calibration again.

1. Select [Calibration (CAL)].

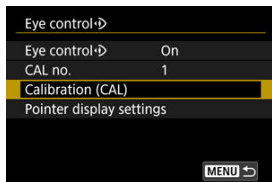

2. Select [Delete].

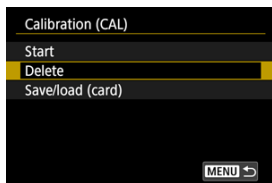

3. Delete the calibration data.

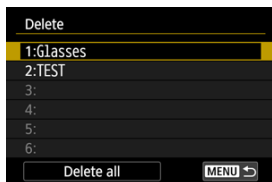

- Select the data to delete and press < (SET) >.
- To delete all calibration data, select [Delete all] and press < (SET) >.
- After you select [OK] on the confirmation screen, the data is deleted.

Basic Operations

- [Holding the Camera](#)
- [Shutter Button](#)
- [< !\[\]\(3da2b303d29c1ea489bbe26a3f5ac664_img.jpg\) > Main Dial](#)
- [< !\[\]\(9421cea5a5b5319f79b58962509475ab_img.jpg\) > Quick Control Dial 1](#)
- [< !\[\]\(17cce402a0380c36f25e02ecf91578f5_img.jpg\) > Quick Control Dial 2](#)
- [< !\[\]\(1086da34995924f924c8e8e23387d139_img.jpg\) > Multi-Controller](#)
- [< **MODE** > Mode Button](#)
- [< **M-Fn** > Multi-Function Button](#)
- [< **AF-ON** > AF Start Button/Smart Controller](#)
- [< **LOCK** > Multi-Function Lock Switch](#)
- [< !\[\]\(ffa6dd4cd8800071ccc1a355540c540c_img.jpg\) > LCD Panel Info Switching/Illumination Button](#)
- [Vertical Shooting](#)
- [Time Display](#)
- [< !\[\]\(dfba61b58454dd961d978e324a1fb5e5_img.jpg\) > Control Ring](#)
- [Button Backlighting](#)
- [< **INFO** > Info Button](#)

Holding the Camera

● Viewing the screen as you shoot

As you shoot, you can tilt the screen to adjust it. For details, see [Using the Screen](#).



- (1) Normal angle
- (2) Low angle
- (3) High angle

● Shooting through the viewfinder

To obtain sharp images, hold the camera still to minimize camera shake.

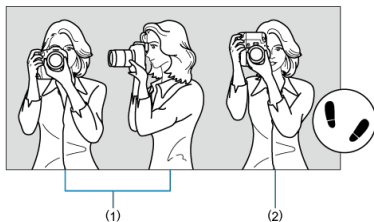

- (1) Horizontal shooting
- (2) Vertical shooting

1. With your right hand, hold the camera firmly by the camera grip.
2. With your left hand, support the lens from below.
3. Rest your right index finger lightly on the shutter button.
4. Rest your arms and elbows lightly against the front of your body.
5. To maintain a stable stance, place one foot slightly ahead of the other.
6. Hold the camera near your face and look through the viewfinder.

Shutter Button

The shutter button has two steps. You can press the shutter button halfway. Then you can further press the shutter button completely.

Pressing halfway

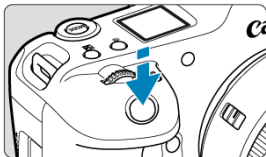

This activates autofocus and the automatic exposure system that sets the shutter speed and aperture value.

The exposure value (shutter speed and aperture value) is displayed on the screen, in the viewfinder, or on the LCD panel for 8 sec. (metering timer/)8).

Pressing completely

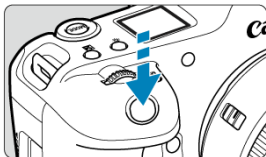

This releases the shutter and takes the picture.

● Preventing camera shake

Hand-held camera movement during the moment of exposure is called camera shake. It can cause blurred pictures. To prevent camera shake, note the following:

- Hold the camera still, as shown in [Holding the Camera](#).
- Press the shutter button halfway to autofocus, then slowly press the shutter button completely.



Note

- The camera will still pause before taking a picture if you press the shutter button completely without pressing it halfway first, or if you press the shutter button halfway and immediately press it completely.
- Even during menu display or image playback, you can return to shooting standby by pressing the shutter button halfway.

(1) After pressing a button, turn the <  > dial.

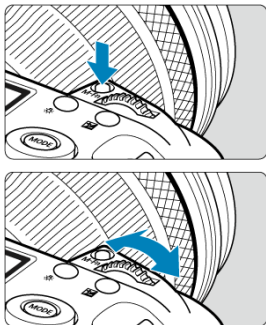



Press a button such as <MODE>, <DRIVE•AF>, <• >, or <M-Fn>, then turn the <  > dial.

If you press the shutter button halfway, the camera will go back to shooting standby.

- Used for operations such as setting the ISO speed, drive mode, AF operation, white balance, and flash exposure compensation.

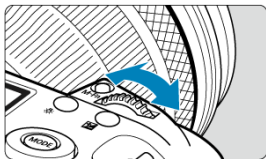
(2) Turn only the <  > dial.



Turn the <  > dial while looking at the screen, viewfinder, or LCD panel.

- Use this dial to set the shutter speed, aperture value, etc.

 **Note**

- The operations in (1) can be performed even when controls are locked with the Multi-function lock () .

< > Quick Control Dial 1

(1) After pressing a button, turn the <  > dial.

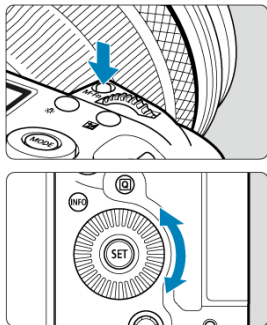



Press a button such as <MODE>, <DRIVE•AF>, <•• >, or <M-Fn>, then turn the <  > dial.

If you press the shutter button halfway, the camera will go back to shooting standby.

- Used for operations such as selecting the ISO speed, drive mode, AF operation, white balance, and flash exposure compensation.

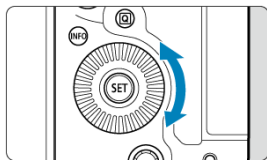
(2) Turn only the <  > dial.



Turn the <  > dial while looking at the screen, viewfinder, or LCD panel.

- Used for operations such as setting the exposure compensation amount and the aperture value setting for manual exposures.

Note

- The operations in (1) can be performed even when controls are locked with the Multi-function lock ().

(1) After pressing a button, turn the <  > dial.

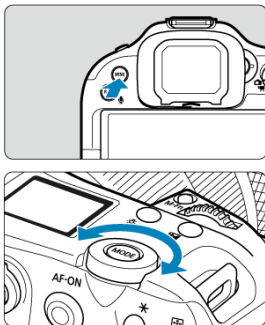

Press a button such as < MENU >, then turn the <  > dial.

If you press the shutter button halfway, the camera will go back to shooting standby.

- Used for operations such as switching between main tabs on the menu screen.

(2) Turn only the <  > dial.



Turn the <  > dial while looking at the screen, viewfinder, or LCD panel.

- Used for operations such as setting the ISO speed.

 **Note**

- The operations in (1) can be performed even when controls are locked with the Multi-function lock ().

< * > Multi-Controller

< * > is an eight-direction key with center button. To use it, press lightly with the tip of your thumb.

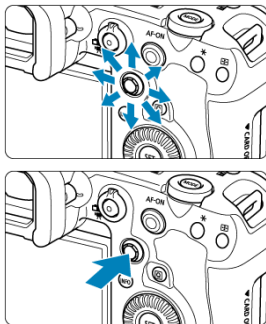





- Examples of using the Multi-controller
 - AF point/magnified frame movement in still photo shooting or movie recording
 - White balance correction
 - Magnified area position movement during playback
 - Quick Control
 - Selecting or setting menu items

<MODE> Mode Button

You can set the shooting mode.



- Press the <MODE> button, then use <  >, <  >, <  >, or <  > to select a shooting mode.

<M-Fn> Multi-Function Button

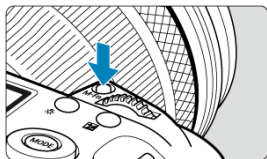

By pressing the <M-Fn> button and turning the <☉> dial, you can set the ISO speed (☑), drive mode (☑), AF operation (☑), white balance (☑), and flash exposure compensation (☑).

To select the AF area, press the <☒> button (☑6), then press the <M-Fn> button.

< AF-ON > AF Start Button/Smart Controller

On this control, you can press the center or drag with your finger.

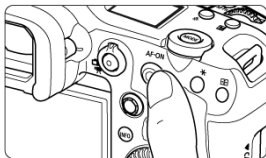
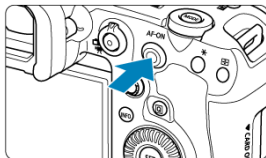

- Pressing the < AF-ON > button activates autofocus. This is equivalent to pressing the shutter button halfway.
- You can move the AF point by dragging on the smart controller after pressing the < AF-ON > button. You can also adjust the sensitivity—the amount the AF point moves in response to dragging (see page 107).
- [Direct AF pt sel (during meter)] can be assigned to this control by selecting [Smart controller] in [Customize buttons]. Assigning this function enables direct selection of AF points as long as the metering timer is running.

! Caution

Precautions when using the smart controller

- In case of poor responsiveness if you are wearing gloves, use this control without wearing the gloves.
- The camera may not respond to touch operations with wet fingers.

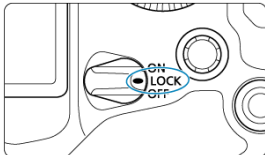

<LOCK> Multi-Function Lock Switch

Configuring [**Multi function lock**] (🔒) and setting the power/multi-function lock switch to <LOCK> prevents settings from being changed by accidentally touching the Main dial, Quick Control dials, Multi-controller, control ring, or touch-screen panel.



< > LCD Panel Info Switching/Illumination Button



- Each press of the <  > button changes the information on the LCD panel.
- Illuminate the LCD panel by holding down the <  > button ()

Vertical Shooting

Vertical shooting controls such as buttons, dials, and a Multi-controller are arranged near the bottom of the camera (P).

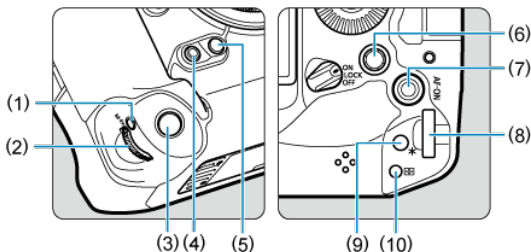

-
- (1) Vertical-grip Multi-function button
 - (2) Vertical-grip Main dial
 - (3) Vertical-grip shutter button
 - (4) Vertical-grip Multi-function button 2
 - (5) Vertical-grip depth-of-field preview button
 - (6) Vertical-grip Multi-controller
 - (7) Vertical-grip AF start button/Smart controller
 - (8) Vertical-grip Quick control dial 2
 - (9) Vertical-grip AE lock button
 - (10) Vertical-grip AF point selection button
-



Time Display

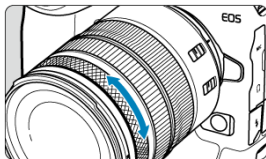

Press the  button to display the time when you are looking through the viewfinder (⌚6).

< > Control Ring



By default, exposure compensation can be set by turning the control ring of RF lenses or mount adapters while pressing the shutter button halfway in **[Fv]**, **[P]**, **[Tv]**, **[Av]**, or **[M]** mode. Otherwise, you can assign a different function to the control ring by customizing operations in [: **Customize dials**] ().

Button Backlighting

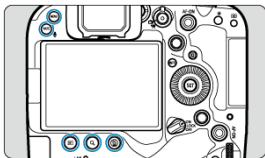

< MENU >, < ▶ >, < Q >, < 🗑️ >, and < RATE / 🎤 > button backlighting is activated during LCD panel illumination, menu or Quick Control screen display, or image playback. This makes it easier to see the button layout in low-light locations. Button backlighting is deactivated when the metering timer starts, which is triggered by pressing the shutter button halfway, for example.

<INFO> Info Button

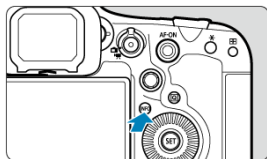

Each press of the <INFO> button changes the information shown. The following sample screens are for still photos.

(1)



(5)



(2)



(4)

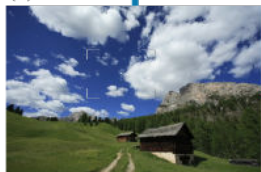

(3)



Menu Operations and Settings

[Menu Screen](#)

[Menu Setting Procedure](#)

[Dimmed Menu Items](#)

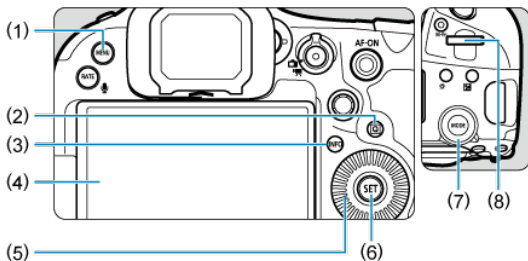

(1) <MENU> button

(2) <Q> button

(3) <INFO> button

(4) Screen

(5) <○> Quick control dial 1

(6) <SET> button

(7) <☺> Quick control dial 2

(8) <☺> Main dial

Menu Screen

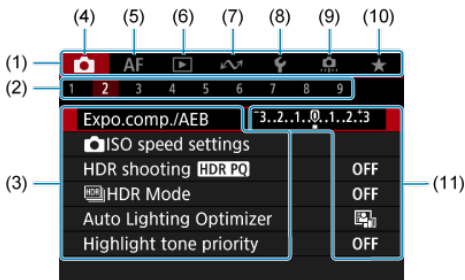

-
- (1) Main tabs

 - (2) Secondary tabs

 - (3) Menu items

 - (4) : Shooting

 - (5) **AF**: Autofocus

 - (6) : Playback

 - (7) : Communication functions

 - (8) : Set-up

 - (9) : Custom Functions

 - (10) : My Menu

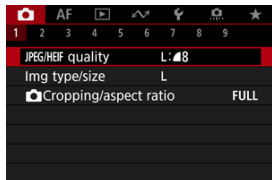

 - (11) Menu settings
-

1. Display the menu screen.



- Press the < MENU > button to display the menu screen.

2. Select a tab.

- Each time you turn the <  > dial, the main tab (group of functions) will switch. You can also switch tabs by pressing the <  > button.
- Turn the <  > dial to select a secondary tab.

3. Select an item.

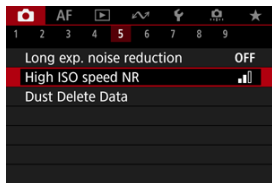

- Turn the <  > dial to select an item, then press <  >.

4. Select an option.



- Turn the <  > dial to select an option.
- The current setting is indicated in blue.

5. Set an option.

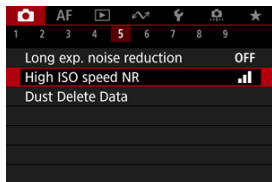

- Press <  > to set it.

6. Exit the setting.

- Press the < MENU > button to return to shooting standby.

Note

- The description of menu functions hereafter assumes that you have pressed the < MENU > button to display the menu screen.
- Menu operations are also possible by tapping the menu screen or using <  >.
- To cancel the operation, press the < MENU > button.

Dimmed Menu Items

Example: When focus bracketing has been set

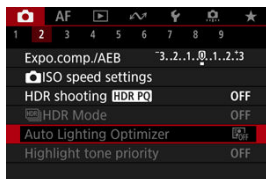

Dimmed menu items cannot be set. The menu item is dimmed if another function setting is overriding it.

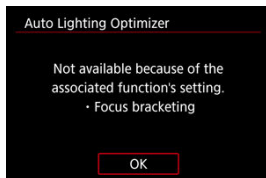

You can see the overriding function by selecting the dimmed menu item and pressing < (SET) >.

If you cancel the overriding function's setting, the dimmed menu item will become settable.

Caution

- You may not be able to see the overriding function for certain dimmed menu items.

Note

- In [**Reset camera**], you can reset menu functions to the default settings by selecting [**Basic settings**] in [**Reset individual settings**] (🔗).

Quick Control

You can directly and intuitively select and set the settings displayed.

1. Press the **< Q >** button (⌚10).

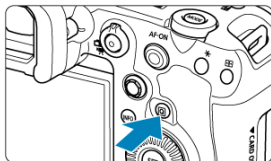

Touch-Screen Operation

[Tapping](#)

[Dragging](#)

Tapping

Sample screen (Quick Control)



- Use your finger to tap (touch briefly and then remove your finger from) the screen.
- For example, when you tap [Q], the Quick Control screen appears. By tapping [Q], you can return to the preceding screen.

Note

- To have the camera beep for touch operations, set [🔊: Beep] to [Enable] (🔊).
- Responsiveness to touch operations can be adjusted in [🔊: Touch control] (🔊).

Dragging

Sample screen (Menu screen)

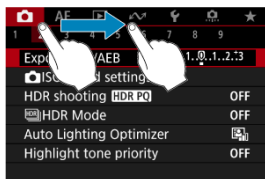

- Slide your finger while touching the screen.

Shooting Mode

This chapter describes shooting modes.

- [Fv: Flexible-Priority AE](#)
- [P: Program AE](#)
- [Tv: Shutter-Priority AE](#)
- [Av: Aperture-Priority AE](#)
- [M: Manual Exposure](#)
- [BULB: Long \(Bulb\) Exposures](#)

Fv: Flexible-Priority AE

In this mode, you can set shutter speed, aperture value, and ISO speed manually or automatically and combine these settings with your choice of exposure compensation. Shooting in **[Fv]** mode, with control over each of these parameters, is equivalent to shooting in **[P]**, **[Tv]**, **[Av]**, or **[M]** mode.

* **[Fv]** stands for Flexible value.



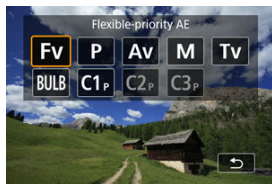

1. Set the shooting mode to **[Fv]**.



- Press the **<MODE>** button, then turn the  dial to select **[Fv]**.

2. Set the shutter speed, aperture value, and ISO speed.



- Turn the  dial to select an item to set.  appears to the left of the selected item.
- Turn the  dial to set the option.
- To reset the setting to **[AUTO]**, press the  button.

3. Set the amount of exposure compensation.



- Turn the < > dial and select the exposure level indicator. [] or [] appears to the left of the exposure level indicator.
- Turn the < > or < > dial to set the level.
- To reset the setting to $[\pm 0]$, press the < > button.

Combinations of functions in [FV] mode

Shutter Speed	Aperture Value	ISO Speed	Exposure Compensation	Shooting Mode
[AUTO]	[AUTO]	[AUTO]	Available	Similar to [P]
		Manual selection		
Manual selection	[AUTO]	[AUTO]	Available	Similar to [Tv]
		Manual selection		
[AUTO]	Manual selection	[AUTO]	Available	Similar to [Av]
		Manual selection		
Manual selection	Manual selection	[AUTO]	Available	Similar to [M]
		Manual selection		

Caution

- Blinking of the values indicates a risk of underexposure or overexposure. Adjust the exposure until the value stops blinking.
Slow synchro is not used under low light when you have set up [Fv] mode to resemble [Av] or [P] mode, even when [Slow synchro] in [: External Speedlite control] is set to [1/250-30sec. auto] (or [1/200-30sec. auto]).



Note

- Values for shutter speed, aperture value, and ISO speed that are set to **AUTO** are underlined.
- You can set shutter speed, aperture value, and ISO speed to **AUTO** and exposure compensation amount to **±0** in step 2 or 3 by holding down the <  > button.

P: Program AE

The camera automatically sets the shutter speed and aperture value to suit the subject's brightness.

* [P] stands for Program.

* AE stands for Auto Exposure.

1. Set the shooting mode to [P].



- Press the <MODE> button, then turn the <MODE> dial to select [P].

2. Focus on the subject.

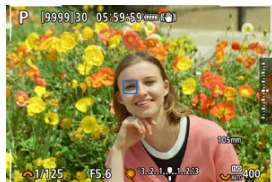

- Aim the AF point over the subject and press the shutter button halfway.
- Once the subject is in focus, the AF point turns blue (or with One-Shot AF, green).
- The shutter speed and aperture value are set automatically.

3. Check the display.



- As long as the exposure value is not blinking, standard exposure will be obtained.

4. Take the picture.

- Compose the shot and press the shutter button completely.

Caution



- If the "30" shutter speed and the lowest aperture value blink, it indicates underexposure. Increase the ISO speed or use flash.



- If the "1/8000" shutter speed and the highest aperture value blink, it indicates overexposure. Lower the ISO speed or use an ND filter (sold separately) to reduce the amount of light entering the lens.

Note

Program shift

- In [P] mode, you can freely change the combination (program) of shutter speed and aperture value set automatically by the camera while maintaining the same exposure. This is called Program shift.
- With Program shift, you can press the shutter button halfway, then turn the  dial until the desired shutter speed or aperture value is displayed.
- Program shift will be canceled automatically when the metering timer ends (exposure setting display turns off).
- Program shift cannot be used with flash.

Tv: Shutter-Priority AE

In this mode, you set the shutter speed and the camera automatically sets the aperture value to obtain the standard exposure matching the brightness of the subject. A faster shutter speed can freeze the action of a moving subject. A slower shutter speed can create a blurred effect, giving the impression of motion.

* [Tv] stands for Time value.



Blurred motion
(Slow speed: 1/30 sec.)



Frozen motion
(Fast speed: 1/2000 sec.)

1. Set the shooting mode to [Tv].

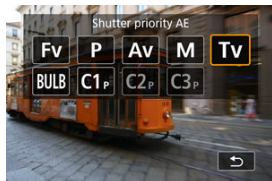

- Press the <MODE> button, then turn the <MODE> dial to select [Tv].

2. Set the desired shutter speed.



- Turn the <  > dial to set it.

3. Focus on the subject.

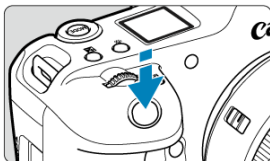

- Press the shutter button halfway.
- The aperture value is set automatically.

4. Check the display and shoot.



- As long as the aperture value is not blinking, the standard exposure will be obtained.

Caution



- If the lowest aperture value blinks, it indicates underexposure.
Turn the <  > dial to set a slower shutter speed until the aperture value stops blinking or set a higher ISO speed.



- If the highest aperture value blinks, it indicates overexposure.
Turn the <  > dial to set a faster shutter speed until the aperture value stops blinking, or set a lower ISO speed.

 **Note****Shutter speed display**

- For example, "0"5" indicates 0.5 sec. and "15"', 15 sec.
- Shutter speeds from "64000" to "4" on the LCD panel indicate the denominator of the fractional shutter speed.

Av: Aperture-Priority AE

[Depth-of-Field Preview](#)

In this mode, you set the desired aperture value and the camera sets the shutter speed automatically to obtain the standard exposure matching the subject brightness. A higher $f/$ number (smaller aperture hole) will make more of the foreground and background fall within acceptable focus. On the other hand, a lower $f/$ number (larger aperture hole) will make less of the foreground and background fall within acceptable focus.

* **[Av]** stands for Aperture value (aperture opening).



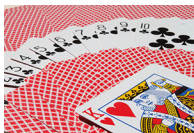

Blurred background
(With a low aperture value: $f/5.6$)

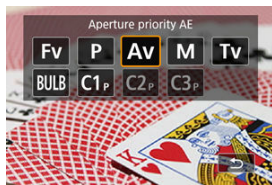

Sharp foreground and background
(With a high aperture value: $f/32$)

1. Set the shooting mode to **[Av]**.



- Press the **<MODE>** button, then turn the  dial to select **[Av]**.

2. Set the desired aperture value.



- Turn the <  > dial to set it.

3. Focus on the subject.

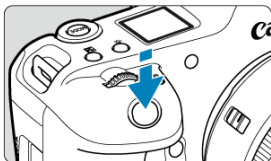

- Press the shutter button halfway.
- The shutter speed is set automatically.

4. Check the display and shoot.



- As long as the shutter speed is not blinking, the standard exposure will be obtained.

Caution



- If the "30" shutter speed blinks, it indicates underexposure.
Turn the <  > dial to decrease the aperture value (open the aperture) until the shutter speed blinking stops or set a higher ISO speed.



- If the "1/8000" shutter speed blinks, it indicates overexposure.
Turn the <  > dial to increase aperture value (close the aperture) until the shutter speed blinking stops or set a lower ISO speed.

 **Note**

Aperture value display

- The higher the value, the smaller the aperture opening will be. The aperture value displayed varies depending on the lens. If no lens is attached to the camera, "F00" will be displayed for the aperture.

Depth-of-Field Preview

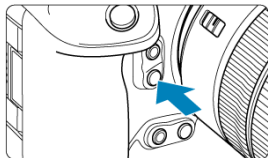

Press the depth-of-field preview button to stop down the lens to the current aperture value setting and check the area in focus (depth of field).

 **Note**

- The larger the aperture value, the wider the area in focus, from the foreground to the background.
- The depth-of-field effect is readily apparent on images as you change the aperture value and press the depth-of-field preview button.
- Exposure is locked (AE lock) as you hold down the depth-of-field preview button.

M: Manual Exposure

[Exposure Compensation with ISO Auto](#)

In this mode, you set both the shutter speed and aperture value as desired. To determine the exposure, refer to the exposure level indicator or use a commercially available exposure meter.



* **[M]** stands for Manual.

1. Set the shooting mode to **[M]**.





- Press the <MODE> button, then turn the < > dial to select **[M]**.

2. Set the ISO speed ().

- Turn the < > dial to set it.
- With ISO Auto, you can set exposure compensation ().

3. Set the shutter speed and aperture value.



- To set the shutter speed, turn the < > dial, and to set the aperture value, turn the < > dial.

4. Focus on the subject.



- Press the shutter button halfway.
- Check the exposure level mark [] to see how far the current exposure level is from the standard exposure level.

- (1) Standard exposure index
(2) Exposure level mark

5. Set the exposure and take the picture.



- Check the exposure level indicator and set the desired shutter speed and aperture value.

Exposure Compensation with ISO Auto









If the ISO speed is set to [AUTO] for manual exposure shooting, you can set exposure compensation (☑) as follows:

- Tap the exposure level indicator
- [📷: Expo.comp./AEB]
- Quick Control screen
- Turn the control ring while pressing the shutter button halfway

⚠ Caution

- Exposure may not be as expected when ISO Auto is set, because the ISO speed is adjusted to ensure standard exposure for your specified shutter speed and aperture value. In this case, set the exposure compensation.
- Exposure compensation is not applied in flash photography with ISO Auto, even if you have set an exposure compensation amount.

 **Note**

- In **[M]** mode with ISO Auto, **[ (evaluative metering), and **[: AE lock meter. mode after focus]** set to the default setting (****), holding down the shutter button halfway locks the ISO speed after the camera focuses with One-Shot AF.**
- When ISO Auto is set, you can press the **<  >** button to lock the ISO speed.
- If you press the **<  >** button and recompose the shot, you can see the exposure level difference on the exposure level indicator compared to when the **<  >** button was pressed.
- Any existing exposure compensation amount is maintained if you switch to **[M]** mode with ISO Auto after using exposure compensation in **[P]**, **[Tv]**, or **[Av]** mode (****).
- To coordinate exposure compensation in 1/2-stop increments with ISO speed set in 1/3-stop increments when **[: Exposure level increments]** is set to **[1/2-stop]** and used with ISO Auto, exposure compensation is further adjusted by adjusting shutter speed. However, the shutter speed displayed will not change.

BULB: Long (Bulb) Exposures

[Bulb Timer](#)

In this mode, the shutter stays open as long as you hold down the shutter button completely, and closes when you let go of the shutter button. Use bulb exposures for night scenes, fireworks, astrophotography, and other subjects requiring long exposures.

1. Set the shooting mode to [BULB].

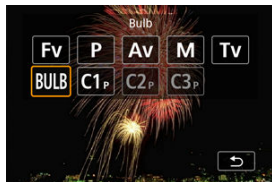

- Press the < MODE > button, then turn the <  > dial to select [BULB].

2. Set the desired aperture value.

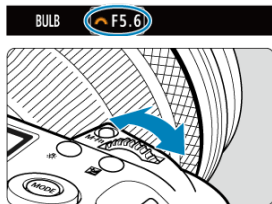

- Turn the <  > dial to set it.



3. Take the picture.

- The exposure will continue for as long as you keep the shutter button pressed completely.
- Elapsed exposure time is displayed on the LCD panel.

Caution

- Do not point the camera toward an intense light source, such as the sun or an intense artificial light source. Doing so may damage the image sensor or the camera's internal components.
- Long bulb exposures produce more noise in the image than usual.
- ISO 400 is used when the camera is set to ISO Auto.
- When shooting bulb exposures with the self-timer instead of the bulb timer, keep pressing the shutter button completely (for the self-timer time and bulb exposure time).

Note

- You can reduce the noise generated during long exposures by using [: **Long exp. noise reduction**] ()
- Using a tripod and the bulb timer is recommended for bulb exposures.
- You can also shoot bulb exposures with Remote Switch RS-80N3 (sold separately, )
- You can also shoot bulb exposures with Wireless Remote Control BR-E1 (sold separately). When you press the remote controller's release (transmit) button, the bulb exposure will start immediately or 2 sec. later. Press the button again to stop the bulb exposure.

Bulb Timer

You can set the exposure time for bulb exposures in advance. This feature eliminates the need to keep holding down the shutter button during bulb exposures, which can reduce camera shake.

Note that the bulb timer can only be set and will only take effect in [BULB] (bulb exposure) mode.

1. Select [: Bulb timer].

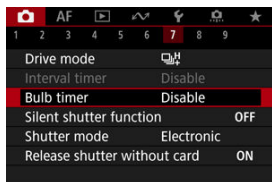

2. Select [Enable].

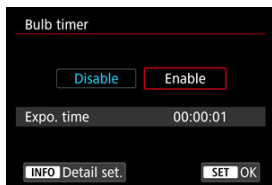

- Select [Enable], then press the <INFO> button.

3. Set the exposure time.

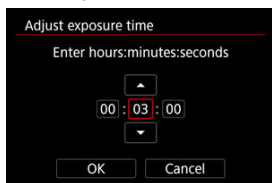

- Select an option (hours : minutes : seconds).
- Press <SET> to display [].
- Set a value, then press <SET>. (Returns to [□].)

4. Select [OK].

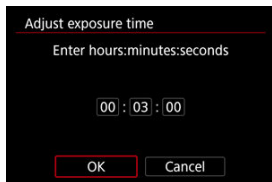

5. Take the picture.

- After you press the shutter button completely, the bulb exposure continues for your specified time.
- [**TIMER**] and the exposure time are displayed on the LCD panel during bulb timer shooting.
- To clear the timer setting, select [**Disable**] in step 2.

! Caution

- Bulb exposure stops if you press the shutter button completely and release it during the timer.
- Bulb exposure continues even after your specified exposure time if you keep pressing the shutter button completely (which overrides automatic stopping when your specified exposure time elapses).
- The bulb timer is cleared (and reverts to [**Disable**]) when you switch shooting modes.

Shooting and Recording

This chapter describes shooting and recording and introduces menu settings on the shooting [📷] tab.

- [Still Photo Shooting](#)
- [Movie Recording](#)

Still Photo Shooting



To prepare for still photo shooting, set the still photo shooting/movie recording switch to , then press the <MODE> button and choose a shooting mode.

- [Tab Menus: Still Photo Shooting](#)
- [Image Quality](#)
- [Still Photo Cropping/Aspect Ratio](#)
- [Auto Exposure Bracketing \(AEB\)](#)
- [ISO Speed Settings for Still Photos](#)
- [HDR PQ Settings](#)
- [HDR Mode](#)
- [Auto Lighting Optimizer](#)
- [Highlight Tone Priority](#)
- [Anti-Flicker Shooting](#)
- [High-Frequency Anti-Flicker Shooting](#)
- [Shooting with Speedlites](#)
- [Flash Function Settings](#)
- [White Balance](#)
- [Custom White Balance](#)
- [White Balance Correction](#)
- [Color Space](#)
- [Picture Style Selection](#)
- [Picture Style Customization](#)
- [Picture Style Registration](#)
- [Clarity](#)
- [Lens Aberration Correction](#)
- [Long Exposure Noise Reduction](#)
- [High ISO Speed Noise Reduction](#)
- [Dust Delete Data Acquisition](#)
- [Multiple Exposures](#)

- [Focus Bracketing](#)
- [Panning Assist](#)
- [Interval Timer Shooting](#)
- [Silent Shutter Function](#)
- [Shutter Mode](#)
- [Releasing Shutter without Card](#)
- [Image Stabilizer \(IS Mode\)](#)
- [Customizing Quick Controls](#)
- [Shooting with the Touch Shutter](#)
- [Image Review](#)
- [High-Speed Display](#)
- [Metering Timer](#)
- [Display Simulation](#)
- [Optical Viewfinder Simulation](#)
- [Shooting Information Display](#)
- [Viewfinder Display Format](#)
- [Display Performance](#)
- [Auto Power Off Temperature](#)
- [Metering Mode Selection](#)
- [Manual Exposure Compensation](#)
- [Exposure Lock \(AE Lock\)](#)
- [General Still Photo Shooting](#)

Tab Menus: Still Photo Shooting

● Shooting 1

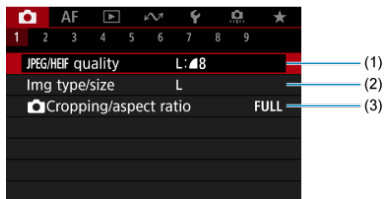

- (1) [JPEG/HEIF quality](#)
- (2) [Img type/size](#)
- (3) [Cropping/aspect ratio](#)

● Shooting 2

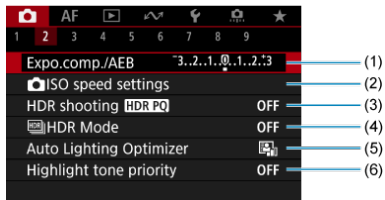

- (1) [Expo.comp./AEB](#)
- (2) [ISO speed settings](#)
- (3) [HDR shooting HDR PQ](#)
- (4) [HDR Mode](#)
- (5) [Auto Lighting Optimizer](#)
- (6) [Highlight tone priority](#)

● Shooting 3

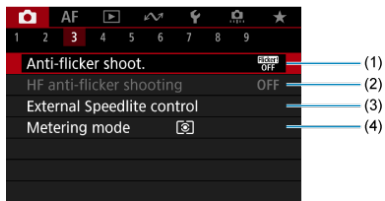

- (1) [Anti-flicker shoot.](#)
- (2) [HF anti-flicker shooting](#)
- (3) [External Speedlite control](#)
- (4) [Metering mode](#)

● Shooting 4

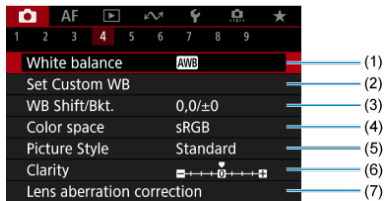

- (1) [White balance](#)
- (2) [Set Custom WB](#)
- (3) [WB Shift/Bkt.](#)
- (4) [Color space](#)
- (5) [Picture Style](#)
 - [Picture Style Selection](#)
 - [Picture Style Customization](#)
 - [Picture Style Registration](#)
- (6) [Clarity](#)
- (7) [Lens aberration correction](#)

● Shooting 5

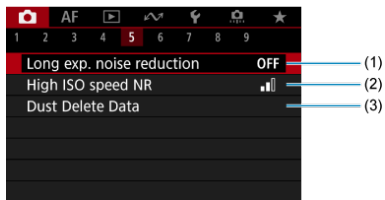

- (1) [Long exp. noise reduction](#)
- (2) [High ISO speed NR](#)
- (3) [Dust Delete Data](#)

● Shooting 6



- (1) [Multiple exposure](#)
- (2) [Focus bracketing](#)
- (3) [Panning Assist](#)

● Shooting 7



- (1) [Drive mode](#)
- (2) [Interval timer](#)
- (3) [Bulb timer](#)
- (4) [Silent shutter function](#)
- (5) [Shutter mode](#)
- (6) [Release shutter without card](#)

● Shooting 8

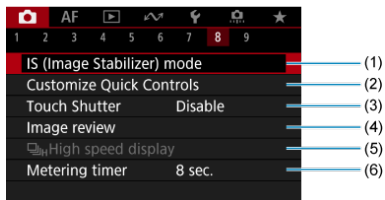

- (1) [IS \(Image Stabilizer\) mode](#)
- (2) [Customize Quick Controls](#)
- (3) [Touch Shutter](#)
- (4) [Image review](#)
- (5) [High speed display](#)
- (6) [Metering timer](#)

! Caution

- **[Camera icon]: IS (Image Stabilizer) mode** is not displayed when an IS-equipped lens is attached.

● Shooting 9

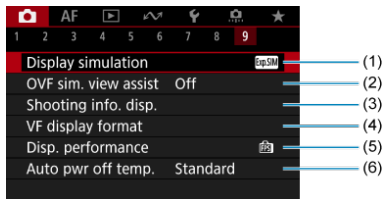

- (1) [Display simulation](#)
- (2) [OVF sim. view assist](#)
- (3) [Shooting info. disp.](#)
- (4) [VF display format](#)
- (5) [Disp. performance](#)
- (6) [Auto pwr off temp.](#)

Image Quality

- [✔ Image Size Selection](#)
- [✔ RAW Images](#)
- [✔ Guide to Image Quality Settings](#)
- [✔ Maximum Burst for Continuous Shooting](#)
- [✔ JPEG/HEIF Quality](#)

Note

- “Image quality” in this guide refers to both image size and JPEG/HEIF quality ([🔗](#)).

Image Size Selection

You can specify **L**, **M**, **S1**, or **S2** for JPEG/HEIF images and **RAW** or **CRAW** for RAW images.

Note

- HEIF can be specified when [**📷: HDR shooting HDR PQ**] is set to [**Enable**]. You can convert these images to JPEG images after shooting ([🔗](#)).

1. Select [**📷: Img type/size**].

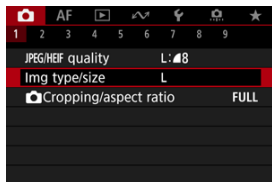



- The screen displayed varies depending on [**📷 Rec options**] settings in [**🔗: Record func+card/folder sel.**].

2. Set the image size.

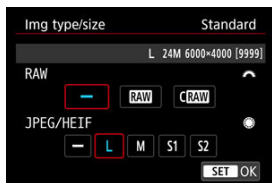



Standard/Auto switch card/Record to multiple

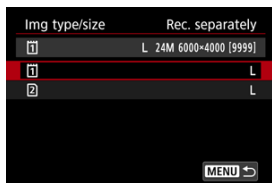

- For RAW images, turn the  dial to select the size, and for JPEG/HEIF images, turn the  dial.
- Press  to set it.

Record separately



- When  **Rec options**] in [ **Record func+card/folder sel.**] is set to **[Rec. separately]**, turn the  dial to select **[1]** or **[2]**, then press . Note that recording separately to **RAW** and **CRAW** is not available for RAW images.



- Select an image size on the screen displayed, then press .





Note

- **L** is set if you set both RAW and JPEG/HEIF to **[—]**.
- Two versions of each shot are recorded at your specified image quality when you have selected both RAW and JPEG/HEIF. Both images have the same file number but each has a different file extension, with .JPG for JPEG, .HIF for HEIF and .CR3 for RAW.
- Meanings of image size icons are as follows: **RAW**: RAW, **CRRAW**: Compact RAW, JPEG: JPEG, HEIF: HEIF, **L**: Large, **M**: Medium, **S1**: Small 1, **S2**: Small 2.

RAW Images

RAW images are raw data from the image sensor that are recorded to the card digitally as **RAW** or **CRAW**, based on your selection. **CRAW** produces RAW images with smaller file sizes than **RAW**.

RAW images can be processed using [: **RAW image processing**] () to save them as JPEG or HEIF images. As the RAW image itself does not change, you can process the RAW image to create any number of JPEG or HEIF images with various processing conditions.

You can use Digital Photo Professional (EOS software) to process RAW images. You can make various adjustments to images depending upon how they will be used and can generate JPEG, HEIF, or other types of images reflecting the effects of those adjustments.



Note

- To display RAW images on a computer, using Digital Photo Professional (EOS software, hereafter DPP) is recommended.
- Older versions of DPP Ver. 4.x do not support display, processing, editing, or other operations with RAW images captured by this camera. If a previous version of DPP Ver. 4.x is installed on your computer, obtain and install the latest version of DPP from the Canon website to update it () , which will overwrite the previous version. Similarly, DPP Ver. 3.x or earlier does not support display, processing, editing, or other operations with RAW images captured by this camera.
- Commercially available software may not be able to display RAW images captured by this camera. For compatibility information, contact the software manufacturer.

Guide to Image Quality Settings

See [Still photo file size / Number of possible shots / Maximum burst for continuous shooting](#) for details on file size, number of shots available, maximum burst, and other estimated values.

Maximum Burst for Continuous Shooting



The approximate maximum burst is displayed at the upper left of the shooting screen and lower right of the viewfinder.

Note

- If the maximum burst is displayed as "99", it indicates that you can shoot 99 or more shots continuously. Fewer shots are available for a value of 98 or lower, and when **[BUSY]** is displayed on the screen, internal memory is full and shooting will stop temporarily. If you stop continuous shooting, the maximum burst will increase. After all captured images have been written to a card, you can once again shoot at the maximum burst listed in [Still photo file size / Number of possible shots / Maximum burst for continuous shooting](#).

1. Select [📷: JPEG/HEIF quality].

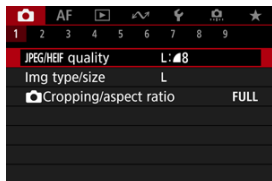

2. Select the desired image size.



- Select the image size, then press < (SET) >.

3. Set the desired quality (compression).



- Select the number, then press < (SET) >.
- Higher numbers offer higher quality (lower compression).
- Quality of 6–10 is indicated by < ▀ >, and 1–5, by < ▴ >.



Note

- The higher the quality, the fewer shots will be available. In contrast, the lower the quality, the more shots will be available.

Still Photo Cropping/Aspect Ratio

Normally with RF or EF lenses, images are captured at the sensor size of approx. 36.0×24.0mm in full-frame shooting, but in cropped shooting, you can isolate and magnify the center of the image approx. 1.6× (APS-C size) as if using a telephoto lens, or you can set an aspect ratio as needed before shooting. RF-S and EF-S lenses capture a 3:2 area in the center at an approx. 1.6 crop factor (APS-C size).

1. Select []: **Cropping/aspect ratio**].

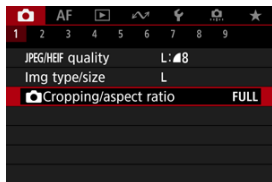

2. Select an option.

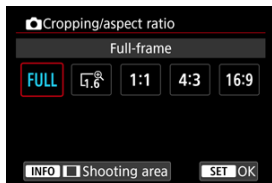

- Select [**Full-frame**], [**1.6x (crop)**], [**1:1 (aspect ratio)**], [**4:3 (aspect ratio)**], or [**16:9 (aspect ratio)**].
- With RF-S and EF-S lenses, [**1.6x (crop)**] is set automatically, and no other option is available.
- To proceed without changing shooting area display, press < > and go to step 4.

3. Select how the shooting area is displayed.

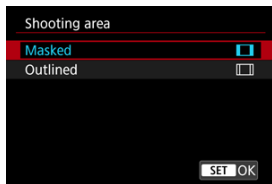

- On the screen in step 2, press the < INFO > button.
- Select the type of display, then press < SET >.

⚠ Caution

- / / / image quality options are not available when [1.6x (crop)] is set, or with RF-S or EF-S lenses.
- Shooting with [1.6x (crop)] and image quality set to / / / produces / / S2 images, respectively.
- Shooting with an RF-S or EF-S lens when [1:1 (aspect ratio)], [4:3 (aspect ratio)], or [16:9 (aspect ratio)] is set automatically clears the setting and shoots with [1.6x (crop)] at a 3:2 aspect ratio.

4. Take the picture.

Setting examples

When FULL is set



When $\square_{1.6}$ is set or an RF-S or EF-S lens is used



When $1:1/\square$ is set



When $4:3/\square$ is set



- When [1.6x (crop)] is set or an RF-S or EF-S lens is used, an image magnified approx. 1.6 is displayed.
- When [1:1 (aspect ratio)], [4:3 (aspect ratio)], or [16:9 (aspect ratio)] is set, the image within the black masked or outlined area is captured.

Caution

- Areas outside the cropped area are not recorded in RAW shooting when [1.6x (crop)] is set, or with RF-S or EF-S lenses.
- [Shooting area] has no effect on display when [1.6x (crop)] is set, or with RF-S or EF-S lenses.
- [📷: Add cropping information] is only available when [Full-frame] is set.
- When external flash units are used, flash auto zoom (automatic adjustment of flash coverage) based on the [📷: 📷Cropping/aspect ratio] setting is not performed.

Note



- For details on pixel counts when cropping or an aspect ratio is set, see [Still photo pixel count](#).
- Nearly 100% field of view coverage is maintained vertically and horizontally when cropping or an aspect ratio is set.
- Aspect ratio information is added to RAW images when an aspect ratio is set, which are captured at full size. When the RAW images are played back, the image area used for shooting is indicated by lines. Note that only the shooting image area is shown in [Slide Show](#).

Auto Exposure Bracketing (AEB)

In exposure bracketing, three consecutive images are captured at different exposures within your specified range of up to ± 3 stops (in 1/3-stop increments) by automatically adjusting the shutter speed, aperture value, or ISO speed.

* AEB stands for Auto Exposure Bracketing.

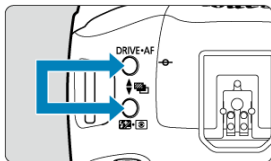

Setting with camera controls

1. Press the <DRIVE•AF> and <• > button at the same time.

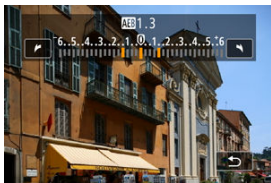

2. Set the AEB range.



- Turn the < >, < >, or < > dial to set the AEB range.
- The AEB range is displayed on the shooting screen when you return to that screen.

3. Take the picture.

Standard exposure



Decreased exposure



Increased exposure



- Three bracketed shots are taken, according to the specified drive mode, in this sequence: Standard exposure, decreased exposure, and increased exposure.
- AEB will not be automatically canceled. To cancel AEB, follow step 2 to set the AEB range to "0."

Setting from the menu

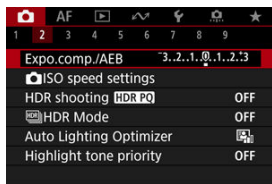

1. Select [Expo.comp./AEB].

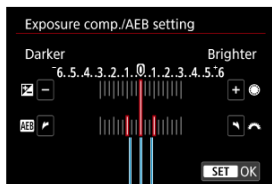

2. Set the AEB range.





(1)

- Turn the <  > dial to set the AEB range (1). By turning the <  > dial, you can set the exposure compensation amount.
- Press <  > to set it.
- When you close the menu, the AEB range will be displayed on the screen.







3. Take the picture.

- Shoot as described in step 3 of [Setting with camera controls](#).
- AEB will not be automatically canceled. To cancel AEB, follow step 2 to turn off the AEB range display.

Caution

- Exposure compensation in AEB may be less effective with  **Auto Lighting Optimizer** () set to an option other than **[Disable]**.

 **Note**

- [] blinks in the lower left of the screen during AEB.
- If the drive mode is set to [], press the shutter button three times for each shot. In [], [], or [] mode, holding down the shutter button completely captures three images, one after another, before the camera automatically stops shooting. When [] or [] is set, three consecutive shots are captured after a delay of 10 or 2 sec.
- You can set AEB in combination with exposure compensation.
- AEB is not available in flash photography or bulb exposures, or when set to Multi Shot Noise Reduction, HDR mode, or focus bracketing.
- AEB will be canceled automatically if you do any of the following: Setting the power switch to < **OFF** > or when the flash is fully charged.

ISO Speed Settings for Still Photos

[ISO Speed Range When Set Manually](#)

[ISO Speed Range Used with ISO Auto](#)

[Minimum Shutter Speed for ISO Auto](#)

Set the ISO speed (image sensor's sensitivity to light) to suit the ambient light level. For details on ISO speed in movie recording, see [ISO Speed in Movie Recording](#).

1. Set the ISO speed.







- With an image displayed on the screen, set by turning the dial.
- ISO speed can be set within ISO 100–102400 in 1/3-stop increments.
- Select **[AUTO]** to set the ISO speed automatically.
- For details on the ISO Auto range, see [ISO speed \(recommended exposure index\) in still photo shooting](#).



ISO speed guide

- Low ISO speeds reduce image noise but may increase the risk of camera/subject shake or reduce the area in focus (shallower depth of field), in some shooting conditions.
- High ISO speeds enable low-light shooting, a larger area in focus (deeper depth of field), and longer flash range but may increase image noise.

Note

- ISO speed can also be set in the ISO speed item by pressing the < M-Fn > button with an image displayed on the screen.
- Can also be set on the [ISO speed] screen in [:  ISO speed settings].
- To expand the manual ISO speed setting range from L (equivalent to ISO 50) to H (equivalent to ISO 204800), adjust [ISO speed range] in [:  ISO speed settings] ().

Caution

- Image noise (dots of light or banding) and irregular colors may increase and apparent resolution may decrease at H (equivalent to ISO 204800), because this is an expanded ISO speed.
- Because L (equivalent to ISO 50) is an expanded ISO speed setting, the dynamic range will be somewhat narrower compared to the standard setting.
- Setting [: **Highlight tone priority**] to [Enable] or [Enhanced] () will prevent you from selecting L (equivalent to ISO 50), ISO 100/125/160, or H (equivalent to ISO 204800).
- When shooting with a high ISO speed, high temperature, long exposure, or multiple exposure, image noise (graininess, dots of light, banding, etc.), irregular colors, or color shift may become noticeable.
- When shooting in conditions that produce an extreme amount of noise, such as a combination of high ISO speed, high temperature, and long exposure, images may not be recorded properly.
- If you use a high ISO speed and flash to shoot a close subject, overexposure may result.

ISO Speed Range When Set Manually

You can set the manual ISO speed setting range (minimum and maximum limits). You can set the minimum limit within L (equivalent to ISO 50) to ISO 102400, and the maximum limit within ISO 100 to H (equivalent to ISO 204800).

1. Select [: ISO speed settings].

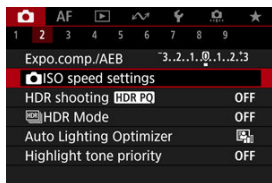

2. Select [ISO speed range].

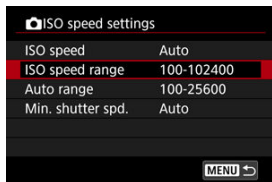



3. Set [Minimum].

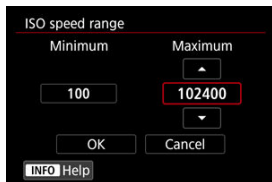

- Select the [Minimum] box, then press < >.
- Select the ISO speed, then press < >.

4. Set [Maximum].



- Select the [**Maximum**] box, then press <  >.
- Select the ISO speed, then press <  >.

5. Select [OK].

ISO Speed Range Used with ISO Auto

You can set the automatic ISO speed range for ISO Auto within ISO 100–51200. The minimum can be set within ISO 100–51200 and the maximum within ISO 200–51200, in 1-stop increments.

1. Select [Auto range].

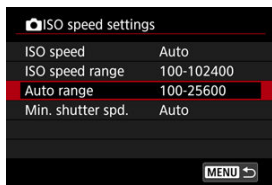

2. Set [Minimum].

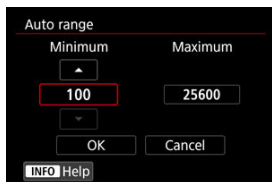

- Select the [Minimum] box, then press < (SET) >.
- Select the ISO speed, then press < (SET) >.

3. Set [Maximum].

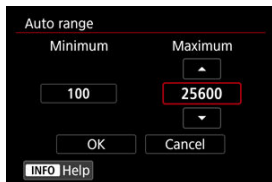

- Select the **[Maximum]** box, then press < **SET** >.
- Select the ISO speed, then press < **SET** >.

4. Select [OK].

Note

- The **[Minimum]** and **[Maximum]** settings will also function as the minimum and maximum speeds for ISO speed safety shift ().

Minimum Shutter Speed for ISO Auto

To prevent shutter speeds from being set too low automatically, you can set the minimum shutter speed for ISO Auto.

This is effective in **[P]** or **[Av]** mode when shooting subjects in motion with a wide-angle lens, or when using a telephoto lens. It can also reduce camera shake and blurred subjects.

1. Select **[Min. shutter spd.]**.

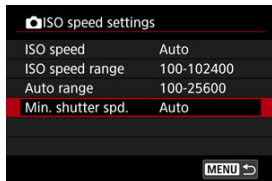

2. Set the desired minimum shutter speed.



Auto

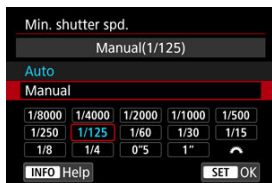

- If you select **[Auto]**, turn the <  > dial to set the difference relative to standard speed (toward **Slower** or **Faster**), then press <  >.

Manual



- If you select **[Manual]**, turn the <  > dial to select the shutter speed, then press <  >.

Caution

- If a correct exposure cannot be obtained with the maximum ISO speed limit set with **[Auto range]**, a shutter speed slower than the **[Min. shutter spd.]** will be set to obtain the standard exposure.
- This function will not be applied to flash photography.

Note

- When **[Auto(Standard)]** is set, the minimum shutter speed will be the reciprocal of the lens focal length. A single step from **[Slower]** to **[Faster]** is equivalent to a single stop of the shutter speed.

HDR PQ Settings

PQ in HDR PQ refers to the gamma curve of the input signal for displaying HDR images. HDR PQ settings enable the camera to produce HDR images conforming to the PQ specification defined in ITU-R BT.2100 and SMPTE ST.2084. (Actual display depends on monitor performance.)

Shots are captured as HEIF or RAW images.

* HDR stands for High Dynamic Range.

* PQ stands for Perceptual Quantization.

1. Select [📷: HDR shooting **HDR PQ**].

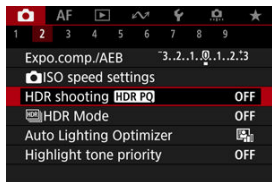

2. Select [Enable].

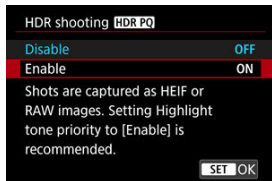

- On the screen during shooting and playback, converted images are displayed that resemble how the images would look on an HDR display device.
- [**VAssist**] and [**HDR PQ**] icons are shown on the screen.

 **Caution**

- Expanded ISO speeds (L, H) are not available in HDR shooting.
- Some scenes may look different from how they appear on an HDR display device.
- Unused signal values are roughly indicated by image areas in gray in the histogram when **[📷: HDR shooting HDR PQ]** is set to **[Enable]**.
- **[📷: Disp. performance]** is not available when **[📷: HDR shooting HDR PQ]** is set to **[Enable]**. It is set to **[Smooth]**.
- For images captured with **[📷: HDR shooting HDR PQ]** set to **[Enable]**, before playback on an HDR display device, set **[▶: HDMI HDR output]** to **[On]** . Note that regardless of the **[▶: HDMI HDR output]** setting, HDR images are used for display on HDR display devices.

HDR Mode

You can shoot still photos with clipped highlights and shadows reduced for a high dynamic range of tones even in high-contrast scenes. HDR shooting is effective for landscape and still-life shots.

HDR shooting enhances gradation in dark image areas by merging three images deliberately captured at different exposures (standard, underexposed, and overexposed) to produce an HDR image that compensates for loss of detail in dark image areas. HDR images are captured as HEIFs or JPEGs.

* HDR stands for High Dynamic Range.

1. Select [HDR] HDR Mode].

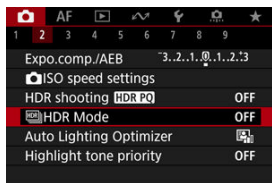

2. Set [Adjust dyn range].

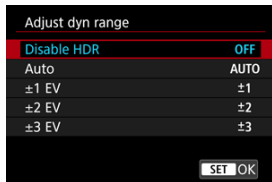

- Selecting [**Auto**] will have the dynamic range set automatically depending on the image's overall tonal range.
- The higher the number, the wider the dynamic range will be.
- To exit HDR shooting, select [**Disable HDR**].

3. Set [Limit max brightness] (only with [📷: HDR shooting **HDR PQ**] set to [Enable]).

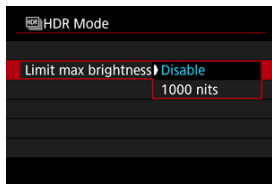

- With [Disable], maximum brightness is not limited. Recommended when you will review images on a monitor supporting display at brightnesses exceeding 1000 nits.
- With [1000 nits], maximum brightness is limited to approx. 1000 nits.

4. Set [Continuous HDR].

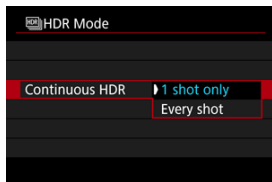

- With [1 shot only], HDR shooting is canceled automatically after you finish shooting.
- With [Every shot], HDR shooting continues until the setting in step 2 is set to [Disable HDR].

5. Set [Auto Image Align].

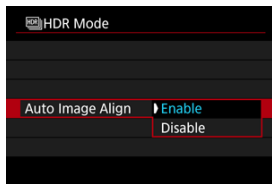

- For handheld shooting, select **[Enable]**. When using a tripod, select **[Disable]**.

6. Set [HDR ghost correc.].

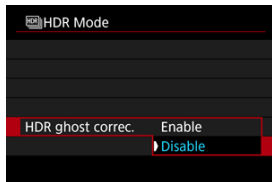

- Shooting moving subjects may leave afterimages of the subject. With **[Enable]**, images are processed to correct ghosting.
- HDR images can be produced faster with **[Disable]** than with **[Enable]**.

7. Specify the images to save.

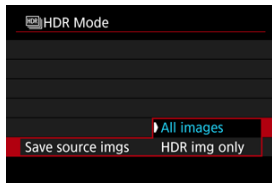

- To save the three images captured and the resulting HDR image, select **[All images]**. The three images can be combined into an HDR image in Digital Photo Professional (EOS software).
- To save only the HDR image, select **[HDR img only]**.

8. Take the picture.

- When you press the shutter button completely, three consecutive images will be captured, and the HDR image will be recorded to the card.

Caution

- Expanded ISO speeds (L, H) are not available in HDR shooting.
- The flash will not fire during HDR shooting.
- AEB is not available.
- In HDR shooting, three images are captured with settings such as shutter speed automatically adjusted. For this reason, even in **[Fv]**, **[Tv]**, and **[M]** modes, the shutter speed and ISO speed will change, relative to your specified shutter speed.
- Images may be brighter in HDR shooting than in normal shooting. If so, adjust exposure compensation or other settings as needed.
- To prevent camera shake, a high ISO speed may be set.
- When shooting HDR images with **[Auto Image Align]** set to **[Enable]**, AF point display information (📍) and Dust Delete Data (📍) will not be appended to the image.
- If you perform handheld HDR shooting with **[Auto Image Align]** set to **[Enable]**, image periphery will be slightly trimmed and resolution will be slightly lowered. Also, if the images cannot be aligned properly due to camera shake, etc., auto image alignment may not take effect. Note that when shooting with excessively bright (or dark) exposure settings, auto image alignment may not work properly.
- If you perform handheld HDR shooting with **[Auto Image Align]** set to **[Disable]**, the three images may not be properly aligned and the HDR effect may be reduced. Using a tripod is recommended.
- Auto image alignment may not function properly with repetitive patterns (lattice, stripes, etc.) or flat, single-tone images.
- Subjects such as the sky or white walls may not be rendered with smooth gradation and may have noise or irregular exposure or colors.
- HDR shooting under fluorescent or LED lighting may cause issues such as irregular exposure or colors in HDR images, due to the flickering light source. It may help reduce the effects of flickering if you set **[Anti-flicker shoot.]** to **[Enable]** or **[HF anti-flicker shooting]** to **[On]**.
- With HDR shooting, the images will be merged, then saved to the card, so it may take some time. **[BUSY]** appears on the screen as images are processed, and shooting is not possible until processing is finished.
- Maximum shutter speed in HDR shooting is 1/8000 sec.



Note

- The electronic shutter is used in HDR shooting.
- Image quality of RAW HDR images is as follows.
 - [📷: HDR shooting **HDR PQ**] set to [**Disable**]: JPEG quality
 - [📷: HDR shooting **HDR PQ**] set to [**Enable**]: HEIF quality

HDR image quality in RAW+JPEG or RAW+HEIF shooting corresponds to your specified JPEG or HEIF image quality.

Auto Lighting Optimizer

Brightness and contrast can be corrected automatically if shots look dark or contrast is too low or high.

1. Select [: Auto Lighting Optimizer].

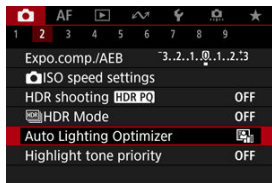

2. Set a correction option.

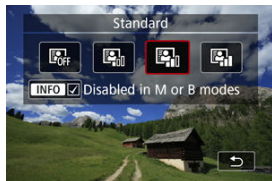

Caution

- Noise may increase and apparent resolution may change, under some shooting conditions.
- If the effect of Auto Lighting Optimizer is too strong and results are not at your preferred brightness, set to [**Low**] or [**Disable**].
- If a setting other than [**Disable**] is set and you use exposure compensation or flash exposure compensation to darken the exposure, the image may still come out bright. If you want a darker exposure, set this function to [**Disable**].



Note

- To enable **[: Auto Lighting Optimizer]** to be set even in **[M]** and **[BULB]** modes, press the **<INFO>** button in step 2 to clear the checkmark **[✓]** for **[Disabled in M or B modes]**.

Highlight Tone Priority

You can reduce overexposed, clipped highlights.

1. Select [📷: Highlight tone priority].

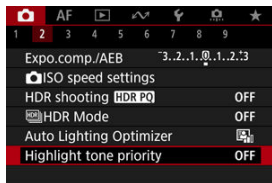

2. Set an option.

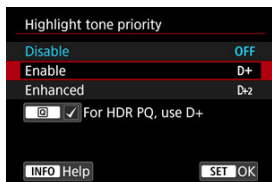







- **[Enable]**: Improves gradation in highlights. The gradation between the grays and highlights becomes smoother.
- **[Enhanced]**: Reduces overexposed highlights even more than **[Enable]**, under some shooting conditions.

⚠ Caution

- Noise may increase slightly.
- The available ISO range starts at ISO 200. Expanded ISO speeds cannot be set.
- With **[Enhanced]**, results in some scenes may not look as expected.

 **Note**

- : **Highlight tone priority** is set to **[Enable]** and cannot be changed when you set : **HDR shooting **HDR PQ**** to **[Enable]** after pressing the <  > button to add a checkmark to this setting.
- : **Highlight tone priority** will be set to **[Disable]** even if you set : **HDR shooting **HDR PQ**** to **[Enable]**, with **[Adjust dyn range]** in : **HDR Mode** set to an option other than **[Disable HDR]**.

Anti-Flicker Shooting

Uneven exposure and color may appear in continuous shooting at fast shutter speeds under flickering light sources such as fluorescent lights, due to uneven vertical exposure. Anti-flicker shooting enables you to take pictures when exposure and colors are less affected by flickering.

1. Select [: Anti-flicker shoot.].

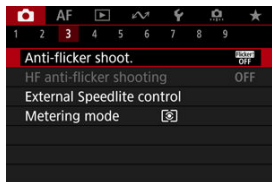

2. Select [Enable].

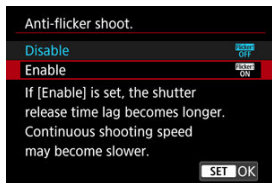



3. Take the picture.

Caution

- When **[Enable]** is set and you shoot under a flickering light source, the shutter-release time lag may become longer.
- Flicker at a frequency other than 50Hz or 60Hz cannot be detected. Also, if the flickering frequency of the light source changes during continuous shooting, effects of the flicker cannot be reduced.
- In **[Fv]**, **[P]**, or **[Av]** mode, color tone of captured images may vary if the shutter speed changes during continuous shooting or if you take multiple shots of the same scene at different shutter speeds. To avoid inconsistent color tone, shoot in **[Fv]**, **[Tv]**, or **[M]** mode at a fixed shutter speed.
- Color tone of captured images may vary between **[Enable]** and **[Disable]**.
- Shutter speed, aperture value, and ISO speed may change when you start shooting with AE lock.
- If the subject is against a dark background or if there is a bright light in the image, flicker may not be properly detected.
- Flicker reduction may not be possible under special lighting.
- Depending on the light source, flicker may not be detected properly.
- Depending on the light sources or shooting conditions, the expected result may not be obtained even if you use this function.
- Exposure in flash photography may vary.

Note

- Taking test shots in advance is recommended.
- Detect flicker manually if the screen flickers (as when the light source changes) by pressing the <  > button, selecting **[ ON]**, then pressing the < **INFO** > button.



High-Frequency Anti-Flicker Shooting

Images may be affected by banding if you shoot under light sources that flicker at high frequencies. High-frequency anti-flicker shooting enables you to take pictures at suitable shutter speeds for high-frequency flickering, which minimizes the effect of this flickering on images.

! Caution

- Exposure in still photo shooting may vary.
- HDR mode is not available in HF anti-flicker shooting.
- Before HF anti-flicker shooting, consider setting [☞: Same expo. for new aperture] to [ISO speed].

1. Set the shooting mode to [Tv] or [M].

- Press the <MODE> button, then turn the <  > dial to select a shooting mode ().

2. Select [☞: HF anti-flicker shooting].

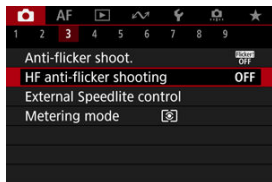

3. Select [HF anti-flicker shooting].

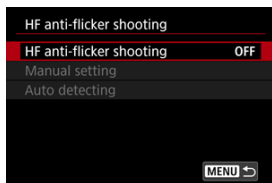

4. Select [On].

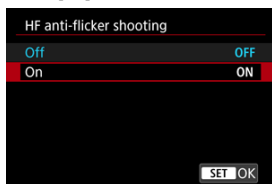

5. Select an option.

Manual setting (☑)

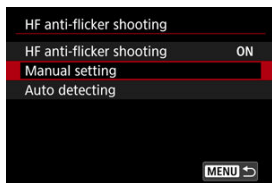

Auto detecting (☑)

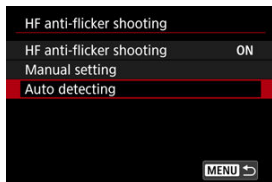

Auto detecting

The camera detects 50.0–2011.2 Hz light sources and displays a suitable shutter speed for shooting under light sources that flicker at high frequencies. You can then switch to the indicated shutter speed.

1. Set the desired shutter speed.

- Set the shutter speed you would prefer to shoot at. For light sources that flicker at high frequencies, the camera will determine a suitable shutter speed near this value.

2. Select [Auto detecting].

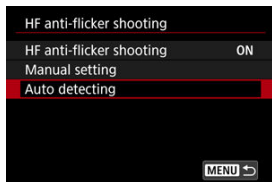

3. Select [OK].

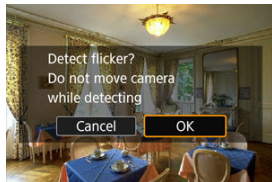

- It may improve HF flicker detection accuracy to magnify, as much as possible, any areas affected by banding.

4. Switch to the indicated shutter speed.



- Select [**Yes**] to switch to the recommended shutter speed.
- Selecting [**Yes (move to Tv settings)**] will display the [**Manual setting**] screen. Go to step 2 in [Manual setting](#).

5. Take the picture.

Caution

- The range of the recommended shutter speed indicated varies by shutter mode.
 - Mechanical shutter: 1/50.0 to 1/1024.0 sec.
 - Electronic first-curtain: 1/50.0 to 1/512.0 sec.
 - Electronic shutter: 1/50.0 to 1/2048.0 sec.
 - Movie recording: 1/50.0 to 1/2048.0 sec.
- Do the following if [**No flicker detected**] is displayed, or if switching shutter speeds does not eliminate banding.
 - Perform automatic detection again
 - Rotate the camera about 90° or switch to automatic detection in other ways
 - Try the manual setting option
- HF flicker detection may be less accurate under these conditions.
 - Scenes with repetitive patterns (with a lattice or stripes, for example)
 - Subjects in constant motion
 - Extremely bright or dark scenes
 - Scenes with multiple light sources
 - Scenes with small flashing light sources
 - Light sources flickering at lower frequencies

Note

- Movie display is not updated if high-frequency flickering is automatically detected during HDMI output of 4K movies.

Manual setting

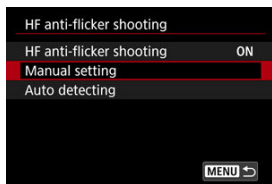

Check on the screen for image areas affected by light sources that flicker at high frequencies, then find a suitable shutter speed.

1. Select [Manual setting].



2. Adjust the shutter speed.



- Do the following if banding is not eliminated at the shutter speed set with automatic detection.
 - Turn the  dial. With the  dial, you can increase the shutter speed set with automatic detection ($\times 2$, $\times 3$, $\times 4$, and so on) or decrease it ($\times \frac{1}{2}$, $\times \frac{1}{3}$, $\times \frac{1}{4}$, and so on).
 - Turn the  dial to fine-tune the setting.
- If this does not eliminate banding, rotate the camera about 90° or switch to automatic detection in other ways.

3. Take the picture.

Caution

- The shutter speed range available for the manual setting mode varies by shutter mode.
 - Mechanical shutter: 1/50.0 to 1/2048.0 sec.
 - Electronic first-curtain: 1/50.0 to 1/2048.0 sec.
 - Electronic shutter: 1/50.0 to 1/8192.0 sec.
 - Movie recording: 1/50.0 to 1/4096.0 sec.
- Maximum flash sync speed in flash photography is limited to 1/159.8 sec. regardless of shutter mode.
- Dark lenses may prevent correct display simulation.
- Safety shift in **[M]** mode adjusts the aperture value as needed in HF anti-flicker shooting.
- Image display on the screen or in the viewfinder may differ from actual shooting results. Take some test shots in advance.

Shooting with Speedlites

- [☑ EL/EX Series Speedlites for EOS Cameras](#)
- [☑ Canon Speedlites Other Than the EL/EX Series](#)
- [☑ Non-Canon Flash Units](#)

EL/EX Series Speedlites for EOS Cameras

Features of EL/EX series Speedlites (sold separately) can be used in flash photography with the camera.



For instructions, refer to the EL/EX series Speedlite's Instruction Manual.

● Sync speed

Varies depending on the shutter mode.

 Shutter mode] Setting	Sync Speed
Mechanical	1/200 sec. or slower
Elec. 1st-curtain	1/250 sec. or slower
Electronic	1/180 sec. or slower



● Flash exposure compensation

You can adjust flash output (flash exposure compensation). With an image displayed on the screen, press the <  > button, turn the <  > dial to select the flash exposure compensation item, then turn the <  > dial to set the flash exposure compensation amount. You can set the flash exposure compensation up to ± 3 stops in 1/3-stop increments.



● FE lock

This enables you to obtain appropriate flash exposure for a specific part of the subject. Aim the viewfinder center over the subject, press the camera's <  > button, then compose the shot and take the picture.

Caution

- Some Speedlites cannot be attached directly to this camera. For details, see [Multi-Function Shoe](#).
- Setting [: **Auto Lighting Optimizer**] () to an option other than [**Disable**] may still cause images to look bright even if you set lower flash exposure compensation for darker images.
- Using high-speed sync may cause banding in images. To reduce the banding, it may help to do the following.
 - Separate the Speedlite from the camera
 - Lower the shutter speed
 - Set [**Shutter synchronization**] to an option other than [**High-speed synchronization**]
 - Set [: **Shutter mode**] to an option other than [**Electronic**]

Note

- The Speedlite will fire an intermittent AF-assist beam as needed, if autofocus is difficult under low light.
- You can also set flash exposure compensation on the Quick Control screen () or in the [**Flash function settings**] setting of [: **External Speedlite control**] ()
- The camera can turn on certain Speedlites automatically when the camera is turned on. For details, refer to the instruction manual of Speedlites that support this feature.

Canon Speedlites Other Than the EL/EX Series

- With an EZ/E/EG/ML/TL series Speedlite set to A-TTL or TTL autoflash mode, the flash can be fired at full output only.
Set the camera's shooting mode to **[M]** or **[Av]** and adjust the aperture value before shooting.
- When using a Speedlite that has manual flash mode, shoot in the manual flash mode.

Non-Canon Flash Units

● Sync speed

Sync speed for non-Canon compact flash units varies by shutter mode.

 Shutter mode] Setting	Sync speed
Mechanical	1/200 sec. or slower
Elec. 1st-curtain	1/250 sec. or slower
Electronic	1/180 sec. or slower

With large studio flash units, the flash duration is longer than that of a compact flash unit and varies depending on the model. Before shooting, confirm that flash sync is performed correctly by taking some test shots at a sync speed of approx. 1/60 sec. to 1/30 sec.

● PC terminal

- You can use flash units with a sync cord via the PC terminal (). The terminal has locking threads to prevent accidental cord detachment.
- The PC terminal has no polarity. Sync cords can be connected regardless of polarity.

Caution

- Using the camera with a dedicated flash unit or flash accessory for cameras of other manufacturers poses a risk of malfunction and even damage.
- Do not connect flash units with an output voltage of 250 V or more to the camera's PC terminal.
- Do not attach a high-voltage flash unit to the camera's hot shoe. It may not fire.

Note

- You can use one flash unit attached to the camera's hot shoe and another connected to the PC terminal at the same time.

Flash Function Settings

- [Flash Firing](#)
- [E-TTL Balance](#)
- [E-TTL II Flash Metering](#)
- [Continuous Flash Control](#)
- [Slow Synchro](#)
- [Flash Function Settings](#)
- [Flash Custom Function Settings](#)
- [Clearing Flash Function Settings/Clearing All Speedlite Custom Functions](#)

Functions of EL/EX Series Speedlites compatible with flash function settings can be set via a camera menu screen. Attach the Speedlite to the camera and turn on the Speedlite before setting the flash functions.

For details on the Speedlite's functions, refer to the Speedlite's Instruction Manual.

1. Select [: External Speedlite control].

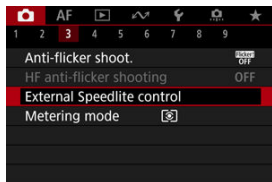

2. Select an option.

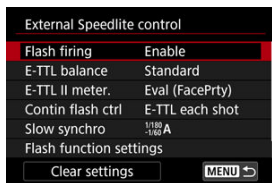

Flash Firing

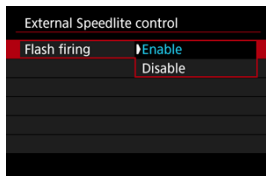

To enable flash photography, set to **[Enable]**. To enable only the AF-assist beam of the Speedlite, set to **[Disable]**.

E-TTL Balance

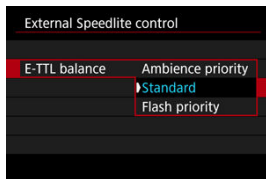

You can set your preferred appearance (balance) for flash shots. This setting enables you to adjust the ratio of ambient light to Speedlite light output.

- Set the balance to **[Ambience priority]** to lower the proportion of flash output and uses ambient light to produce lifelike shots with a natural mood. Especially useful when shooting dark scenes (indoors, for example). After switching to **[Av]** or **[P]** mode, consider setting **[Slow synchro]** in **[CAMERA: External Speedlite control]** to **[1/180-30sec. auto]** (or **[1/250-30sec. auto]**, or **[1/200-30sec. auto]**) and using slow-sync shooting.
- Set the balance to **[Flash priority]** to make the flash the main source of light. Useful for reducing shadows on subjects and in the background from ambient light.

⚠ Caution

- For some scenes, **[Ambience priority]** may yield the same results as **[Standard]**.

E-TTL II Flash Metering

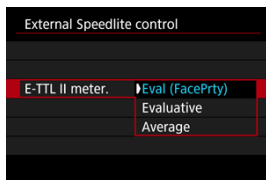

- Set to **[Eval (FacePrty)]** for flash metering suitable for shots of people.
- Set to **[Evaluative]** for flash metering that emphasizes firing in continuous shooting.
- If **[Average]** is set, the flash exposure will be averaged for the entire metered scene.

Note

- Depending on the scene, flash exposure compensation may be necessary.

Caution

- Even when **[Eval (FacePrty)]** is set, some subjects and shooting conditions may prevent you from obtaining the expected result.

Continuous Flash Control

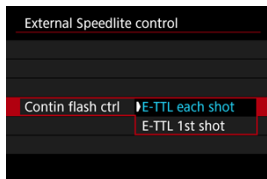

- Set to **[E-TTL each shot]** to perform flash metering for each shot.
- Set to **[E-TTL 1st shot]** to perform flash metering for only the first shot before continuous shooting. The flash output level for the first shot is applied to all subsequent shots. Useful when prioritizing continuous shooting speed without recomposing shots.

⚠ Caution

- Any subject movement in continuous shooting may cause exposure problems.
- **[E-TTL 1st shot]** is set when **[Shutter mode]** is set to **[Elec. 1st-curtain]** or **[Mechanical]** in **[Drive mode]**.

Slow Synchro

You can set the flash-sync speed for flash photography in **[Av]** or **[P]** mode. Note that the maximum flash synchronization speed varies depending on the **[Shutter mode]** setting. It is 1/180 sec. when set to **[Electronic]**, 1/250 sec. for **[Elec. 1st-curtain]**, and 1/200 sec. for **[Mechanical]**.

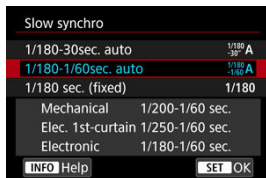

- **1/180-30sec. auto** ($\frac{1}{180}$ A)^{*1*2}

The shutter speed is set automatically in the following range to suit the brightness. High-speed sync is also possible.

[Shutter mode] Setting	Shutter Speed
Mechanical	1/200–30 sec.
Elec. 1st-curtain	1/250–30 sec.
Electronic	1/180–30 sec.

- **1/180-1/60sec. auto** ($\frac{1}{180}$ A)^{*1*3}

Prevents a slow shutter speed from being set automatically in low-light conditions. It is effective for preventing subject blur and camera shake. Light from the flash provides standard exposure for subjects, but note that backgrounds may be dark.

- **1/180 sec. (fixed)** ($\frac{1}{180}$)^{*1*4}

The shutter speed is fixed as follows, which is more effective in preventing subject blur and camera shake than with **[1/180-1/60sec. auto]**^{*1*3}.

[Shutter mode] Setting	Shutter Speed
Mechanical	1/200 sec.
Elec. 1st-curtain	1/250 sec.
Electronic	1/180 sec.

Note that under low light, backgrounds will be darker than with **[1/180-1/60sec. auto]**^{*1*3}.

* 1: When set to **[Electronic]**.

* 2: **[1/250-30sec. auto]** ($\frac{1}{250}$ A) when set to **[Elec. 1st-curtain]** or **[1/200-30sec. auto]** ($\frac{1}{200}$ A) for **[Mechanical]**.

- * 3: [1/250-1/60sec. auto] ($\frac{1}{250}$ A) when set to [Elec. 1st-curtain] or [1/200-1/60sec. auto] ($\frac{1}{200}$ A) for [Mechanical].
- * 4: [1/250 sec. (fixed)] (1/250) when set to [Elec. 1st-curtain] or [1/200 sec. (fixed)] (1/200) for [Mechanical].

 **Caution**

- High-speed sync is not available in [P] or [Av] mode when set to [1/180 sec. (fixed)]^{*1*4}.
- Shutter speed is set to 1/8000 when [: Shutter mode] is [Electronic] and [High-speed synchronization] is selected with a shutter speed of 1/8000 sec. or faster.

Flash Function Settings

The information displayed on the screen, position of display, and available options vary depending on the Speedlite model, its Custom Function settings, the flash mode, and other factors. For details on the Speedlite's functions, refer to the Speedlite's Instruction Manual.

Sample display

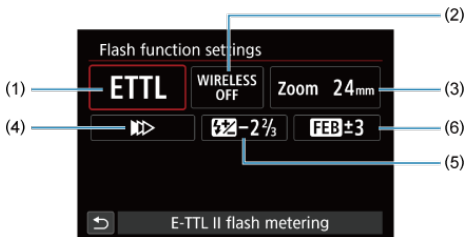

- (1) Flash mode
- (2) Wireless functions / Firing ratio control (RATIO)
- (3) Flash zoom (flash coverage)
- (4) Shutter synchronization
- (5) Flash exposure compensation
- (6) Flash exposure bracketing

Caution

- Functions are limited when using EX series Speedlites that are not compatible with flash function settings.

Flash mode

You can select the flash mode to suit your desired flash photography.

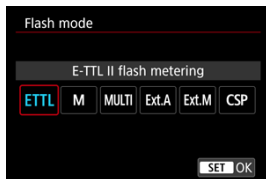

- **[E-TTL II flash metering]** is the standard mode of EL/EX series Speedlites for automatic flash photography.
- **[Manual flash]** is for setting the Speedlite's **[Flash output level]** yourself.
- **[CSP]** (Continuous shooting priority mode) is available when using a compatible Speedlite. This mode automatically reduces flash output by one stop and increases ISO speed by one stop. Useful in continuous shooting, and helps conserve flash battery power.
- Regarding other flash modes, refer to the Instruction Manual of a Speedlite compatible with the respective flash mode.

⚠ Caution

- Adjust exposure compensation (☒) as needed in case of overexposure from flash photography with **[CSP]** in **[Fv]**, **[Tv]**, or **[M]** mode.

📄 Note

- With **[CSP]**, ISO speed is automatically set to **[Auto]**.

Wireless functions

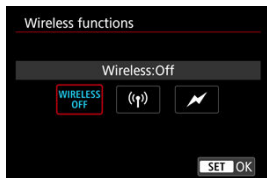

You can use radio or optical wireless transmission to shoot with wireless multiple-flash lighting.

For details on wireless flash, refer to the Instruction Manual of a Speedlite compatible with wireless flash photography.

Firing ratio control (RATIO)



With a macro flash, you can set the firing ratio control.

For details on firing ratio control, refer to the Instruction Manual of the macro flash.

Flash zoom (flash coverage)

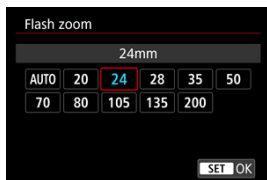

With Speedlites having a zooming flash head, you can set the flash coverage.

Shutter synchronization

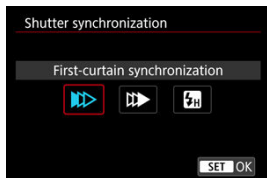

Normally, set this to [**First-curtain synchronization**] so that the flash fires immediately after the shooting starts.

Set to [**Second-curtain synchronization**] and use low shutter speeds for natural-looking shots of subject motion trails, such as car headlights.

Set to [**High-speed synchronization**] for flash photography at higher shutter speeds than the maximum flash sync shutter speed. This is effective when shooting with an open aperture in [**Av**] mode to blur the background behind subjects outdoors in daylight, for example.

Caution

- When using second-curtain synchronization, set the shutter speed to 1/30 sec. or slower. If the shutter speed is 1/40 sec. or faster, first-curtain synchronization will be applied automatically even if [**Second-curtain synchronization**] is set.
- Shutter speed is set to 1/8000 when [**Shutter mode**] is [**Electronic**] and [**High-speed synchronization**] is selected with a shutter speed of 1/8000 sec. or faster.

Flash exposure compensation

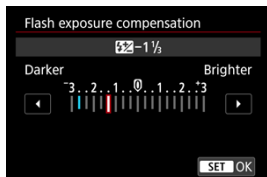

Just as exposure compensation is adjustable, you can also adjust flash output.



Note

- If flash exposure compensation is set with the Speedlite, you cannot set the flash exposure compensation with the camera. If it is set with both the camera and Speedlite, the Speedlite's setting overrides the camera's.

Flash exposure bracketing

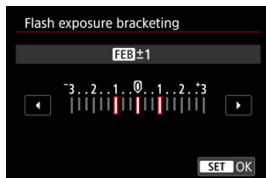

Speedlites equipped with flash exposure bracketing (FEB) can change the external flash output automatically as three shots are taken at once.

Flash Custom Function Settings

For details on the Speedlite's Custom Functions, refer to the Instruction Manual of the Speedlite.

1. Select [Flash C.Fn settings].

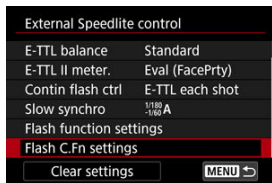

2. Set the desired functions.

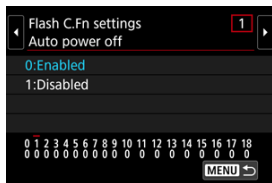

- Select the number.
- Select an option.

Caution

- EX series Speedlites always fire at full output when the [Flash metering mode] Custom Function is set to [1:TTL] (autoflash).
- The Speedlite's Personal Function (P.Fn) cannot be set or canceled from the camera's [📷: External Speedlite control] screen. Set it directly on the Speedlite.

Clearing Flash Function Settings/Clearing All Speedlite Custom Functions

1. Select [Clear settings].

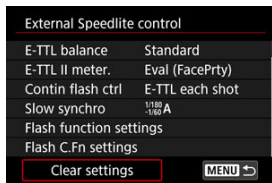

2. Select the settings to be cleared.

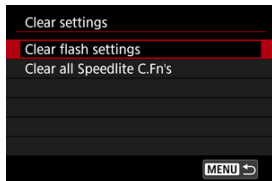

- Select [Clear flash settings] or [Clear all Speedlite C.Fn's].
- Select [OK] on the confirmation screen to clear all flash settings or Custom Function settings.

White Balance

- ☑ [White Balance](#)
- ☑ [\[AWB\] Auto White Balance](#)
- ☑ [\[K\] Setting a Color Temperature](#)

White balance (WB) is for making the white areas look white. Normally, the Auto **[AWB]** (Ambience priority) or **[AWBW]** (White priority) setting will obtain the correct white balance. If natural-looking colors cannot be obtained with Auto, you can select the white balance to match the light source or set it manually by shooting a white object.

1. Press the **<M-Fn>** button (8).

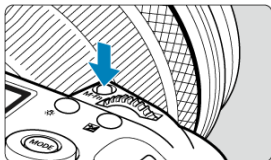

- With an image displayed on the screen, press the **<M-Fn>** button.

2. Select the white balance item.



- Turn the **<8>** dial to select the white balance setting item.

3. Select a white balance setting.













- Turn the <  > dial to make a selection.

Note

- For [AWB] and [AWBW] setting instructions, see [\[AWB\] Auto White Balance](#).
- To set your preferred color temperature, select [K] in [📷 White balance], then turn the <  > dial.

(Approx.)

Display	Mode	Color Temperature (K: Kelvin)
	Auto (Ambience priority)	3000–7000
	Auto (White priority)	
	Daylight	5200
	Shade	7000
	Cloudy, twilight, sunset	6000
	Tungsten light	3200
	White fluorescent light	4000
	When using Flash	Automatically set*
	Custom	2000–10000
	Color temperature	2500–10000

* Applicable with Speedlights having a color temperature transmission function. Otherwise, it will be fixed to approx. 6000K.

White Balance

The human eye adapts to changes in lighting so that white objects look white under all kinds of lighting. Digital cameras determine white from the color temperature of lighting and, based on this, apply image processing to make color tones look natural in your shots.

[AWB] Auto White Balance

With [AWB] (Ambience priority), you can slightly increase the intensity of the image's warm color cast when shooting a tungsten-light scene.

If you select [AWBW] (White priority), you can reduce the intensity of the image's warm color cast.

1. Select [📷: White balance].

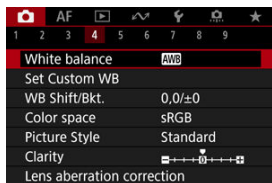

2. Select [AWB].



- With [AWB] selected, press the <INFO> button.

3. Select an option.

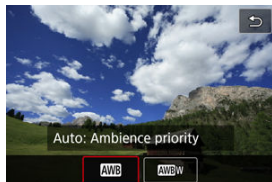

 Caution

Precautions when set to [AWBW] (White priority)

- The warm color cast of subjects may fade.
- When multiple light sources are included in the scene, the warm color cast of the picture may not be reduced.
- When using flash, the color tone will be the same as with [AWB] (Ambience priority).

[K] Setting a Color Temperature

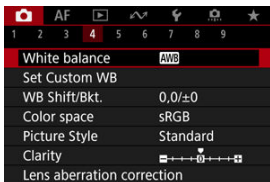

A value can be set representing the white balance color temperature.

1. Select [K]: White balance].

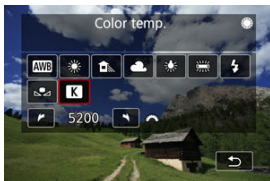

2. Set the color temperature.



- Select [K].
- Turn the <  > dial to set a color temperature, then press <  >.
- The color temperature can be set from approx. 2500K to 10000K in 100K increments.

Note

- When setting the color temperature for an artificial light source, set the white balance correction (magenta or green bias) as necessary.
- When setting [K] to a value measured with a commercially available color temperature meter, take some test shots in advance and adjust the setting as needed to compensate for any difference between the color temperature meter and the camera.

Custom White Balance

- [☑ Registering Custom White Balances](#)
- [☑ Selecting and Shooting with Custom White Balances](#)
- [☑ Naming Custom White Balances](#)

With custom white balance, you can manually set the white balance for the specific light source of the shooting location. Make sure to perform this procedure under the light source at the actual location of the shoot.

Up to five custom white balances can be registered to the camera. You can also add a name (caption) to registered custom white balances. Register separate ones for still photos and movies, as needed.

Registering Custom White Balances

To register custom white balances, you can either register a picture taken during this process or register an image recorded on a card.

Shooting and registering white balances



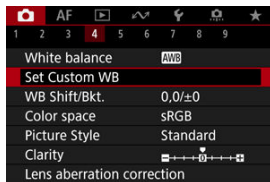

Registration from the menu

1. Select [📷: Set Custom WB].

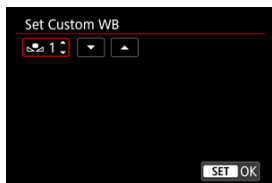

2. Select a custom white balance number to be registered.



- Press <  >.
- Turn the <  > dial to select a number from 1 to 5 for [*], then press <  >. The custom white balance will be registered to the selected number.

3. Select [Record and register WB].

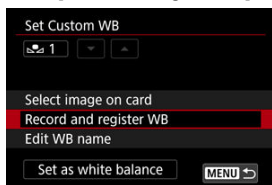

4. Shoot a plain white object.



- The selected number blinks in the upper left of the screen and on the LCD panel.
- Aim the outlined area over a plain white object, so that white fills the area.
- Focus manually and shoot with the standard exposure set for the white object.
- You can use any of the white balance settings.

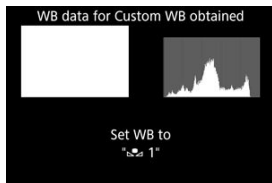

- The custom white balance is registered to the camera.
- To shoot with the registered custom white balance, see [Selecting and Shooting with Custom White Balances](#).

⚠ Caution

- If the exposure obtained in step 4 differs greatly from the standard exposure, a correct white balance may not be obtained.

1. Press the **<Q>** button.

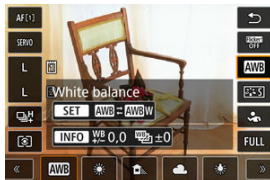

- Select the white balance setting item.

2. Select [Custom].

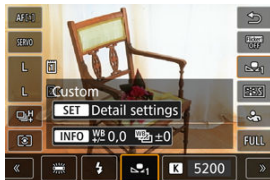

3. Select a custom white balance number to register the white balance data to.

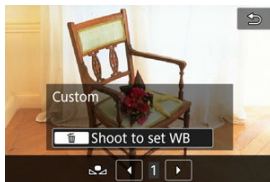

- Turn the **<Q>** dial to select a number from 1 to 5, then press the **<Q>** button.

4. Shoot a plain white object (☑).



- The custom white balance is registered to the camera.
- To shoot with the registered custom white balance, see [Selecting and Shooting with Custom White Balances](#).

Note

- If **[Correct WB may not be obtained with the selected image]** is displayed in step 4, return to step 1 and shoot again.
- Your shot in step 4 is not recorded to a card.
- More accurate white balance can be obtained by shooting a commercially available gray card or standard 18% gray reflector instead of a white object.

Selecting an image recorded on a card

1. Shoot a plain white object.

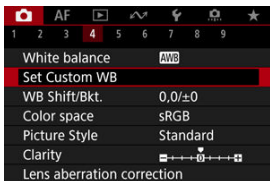

- Shoot a plain white object as described in step 4 in [Shooting and registering white balances](#) (☑).

2. Select [📷: Set Custom WB].

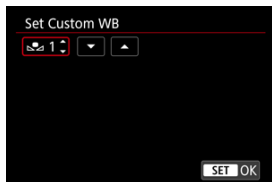

3. Select a custom white balance number to be registered.



- Press < SET >.
- Turn the <  > dial to select a number from 1 to 5 for [*], then press < SET >. The custom white balance will be registered to the selected number.

4. Select [Select image on card].

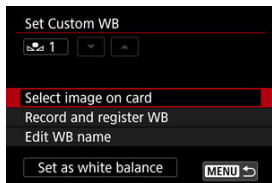

- Images recorded on the card are displayed.

5. Select an image to register as the custom white balance.



- Turn the <  > dial to select the image captured in step 1, then press < SET >.

6. Select [OK].

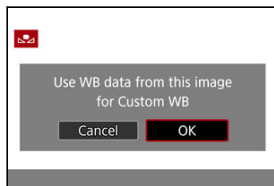

- The custom white balance will be registered to the camera.
- Check the message and select [**OK**] to return to the screen in step 3.

! Caution

- If the exposure obtained in step 1 differs greatly from the standard exposure, a correct white balance may not be obtained.
- The following images cannot be selected: Images captured with the Picture Style set to [**Monochrome**], multiple-exposure images, cropped images, and images shot with another camera.

📄 Note

- To shoot with the registered custom white balance, select it before shooting.

Selecting and Shooting with Custom White Balances

Setting from the menu

1. Select the custom white balance number.



(1) Registered image

- On the **[Set Custom WB]** screen, select the number of the registered custom white balance.

2. Select **[Set as white balance]**.

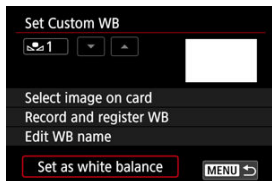

- The white balance setting changes to **[WB*]**.

3. Take the picture.

- The picture is taken with the **[WB*]** setting applied.

1. Press the **< Q >** button.

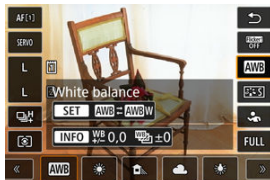

- Select the white balance setting item.

2. Select [Custom].

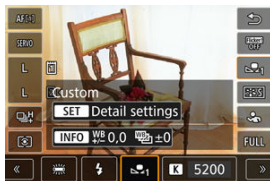

3. Select the custom white balance number.

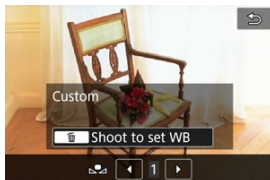

- Turn the **< Q >** dial to select a number from 1 to 5, then press the **< SET >** button.

4. Take the picture.

Naming Custom White Balances

You can add a name (caption) to the five registered custom white balances (custom white balance nos. 1–5).

1. Select the custom white balance number.

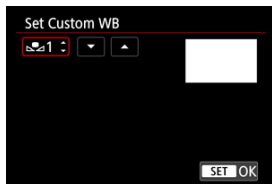

- On the **[Set Custom WB]** screen, select the number of the registered custom white balance to add a name to.

2. Select [Edit WB name].

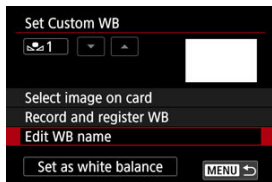

3. Enter text.

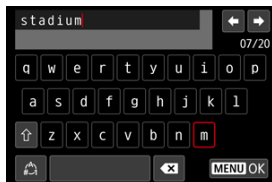

- Use < [] >, < [] >, or < [] > to select a character, then press < [] > to enter it.
- By selecting [[]], you can change the input mode.
- To delete single characters, select [[]] or press the < [] > button.

4. Exit the setting.

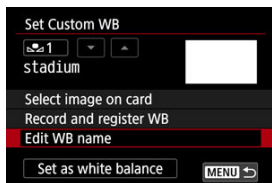

- Press the < [] > button, then press [] .
- The information is saved, and display returns to the screen in step 2.
- The entered name is displayed below [[]] .

Note

- As names, it may be helpful to enter the names of places where you registered the custom white balances, or the names of the light sources.

White Balance Correction

[White Balance Correction](#)

[White Balance Auto Bracketing](#)

You can correct the white balance that is set. This adjustment will have the same effect as using a commercially available color temperature conversion filter or color compensating filter.

White Balance Correction

1. Select [: WB Shift/Bkt.].

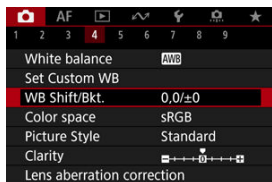

2. Set the white balance correction.

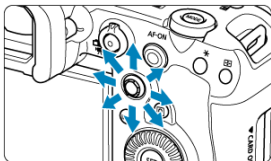

Sample setting: A2, G1



- Use < * > to move the "■" mark on the screen to your preferred position.
- B is for blue, A for amber, M for magenta, and G for green. White balance is corrected in the direction you move the mark.
- The direction and amount of correction are indicated in the upper right of the screen.
- Pressing the < [WB Shift/Bkt.] > button will cancel all the [WB Shift/Bkt.] settings.
- Press < [SET] > to exit the setting.

Note

- One level of the blue/amber correction is equivalent to approx. 5 mireds of a color temperature conversion filter. (Mired: Unit of measure for color temperature used to indicate values such as the density of a color temperature conversion filter.)

White Balance Auto Bracketing

White balance bracketing enables you to capture three images at once with different color tones.

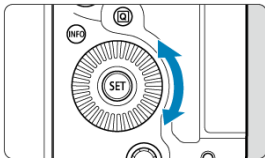

Setting the white balance bracketing amount

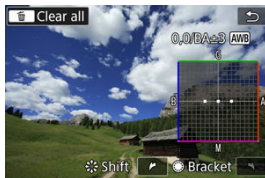

- In step 2 for [White Balance Correction](#), when you turn the <  > dial, the "■" mark on the screen will change to "■ ■ ■" (3 points). Turning the dial clockwise sets the B/A bracketing, and turning it counterclockwise sets the M/G bracketing.

B/A bias ± 3 levels



- The direction and amount of bracketing are indicated in the upper right of the screen.
- Pressing the <  > button will cancel all the [WB Shift/Bkt.] settings.
- Press <  > to exit the setting.

Caution

- During white balance bracketing, the maximum burst for continuous shooting will be lower.
- Since three images are recorded for one shot, it takes longer to record the image to the card.



Note

- The images will be bracketed in the following sequence: 1. Standard white balance, 2. Blue (B) bias, and 3. Amber (A) bias, or 1. Standard white balance, 2. Magenta (M) bias, and 3. Green (G) bias.
- You can also set white balance correction and AEB together with white balance bracketing. If you set AEB in combination with white balance bracketing, a total of nine images will be recorded for a single shot.
- The white balance icon blinks to indicate that white balance bracketing has been set.
- You can change the bracketing sequence (☞) and number of shots (☞) for the white balance bracketing.
- **Bracket** stands for bracketing.

Color Space

[Adobe RGB](#)

The range of reproducible colors is called the “color space.” For normal shooting, sRGB is recommended.

1. Select [: Color space].
2. Set a color space option.

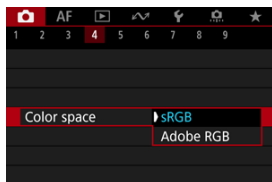

- Select [**sRGB**] or [**Adobe RGB**], then press <  >.

Adobe RGB

This color space is mainly used for commercial printing and other professional applications. Recommended when using equipment such as Adobe RGB-compatible monitors or DCF 2.0 (Exif 2.21 or later) compatible printers.

Note

- File names of still photos shot in the Adobe RGB color space begin with “_”.
- The ICC profile is not appended. For the descriptions about the ICC profile, refer to the Digital Photo Professional Instruction Manual (EOS software).

Picture Style Selection

[Picture Style Characteristics](#)

[Symbols](#)

Just by selecting a preset Picture Style, you can obtain image characteristics effectively matching your photographic expression or the subject.

1. Select [📷: Picture Style].

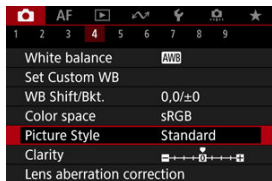

2. Select a Picture Style.



Picture Style Characteristics

-  **Auto**

The color tone will be adjusted automatically to suit the scene. The colors will look vivid for blue skies, greenery and sunsets, particularly in nature, outdoor, and sunset scenes.

 **Note**

- If the desired color tone is not obtained with **[Auto]**, use another Picture Style.

-  **Standard**

The image looks vivid, sharp, and crisp. Suitable for most scenes.

-  **Portrait**

For smooth skin tones, with slightly less sharpness. Suited for close-up portraits. Skin tone can be adjusted by changing **[Color tone]** as described in [Settings and Effects](#).

-  **Landscape**

For vivid blues and greens, and very sharp and crisp images. Effective for impressive landscapes.

-  **Fine Detail**

For detailed rendering of fine subject contours and subtle textures. The colors will be slightly vivid.

-  **Neutral**

For retouching later on a computer. Makes images subdued, with lower contrast and natural color tones.

-  **Faithful**

For retouching later on a computer. Faithfully reproduces the actual colors of subjects as measured in daylight with a color temperature of 5200K. Makes images subdued, with lower contrast.

-  **Monochrome**

Creates black-and-white images.

 **Caution**

- Color images cannot be recovered from JPEG/HEIF images shot with the **[Monochrome]** Picture Style.

-  **User Def. 1–3**

You can add a new style based on presets such as [**Portrait**] or [**Landscape**] or a Picture Style file, then adjust it as needed (). With any User Defined Picture Style that has not yet been registered, pictures will be taken with the same characteristics settings as with the default settings of [**Standard**].

Symbols

Icons on the Picture Style selection screen represent [Strength], [Fineness], and [Threshold] for [Sharpness] as well as [Contrast] and other parameters. The numbers indicate the values for these settings specified for the respective Picture Style.

Picture Style		Picture Style	
Auto	4, 2, 3, 0, 0, 0	Neutral	0, 2, 2, 0, 0, 0
Standard	4, 2, 3, 0, 0, 0	Faithful	0, 2, 2, 0, 0, 0
Portrait	3, 2, 4, 0, 0, 0	Monochrome	4, 2, 3, 0, N, N
Landscape	5, 2, 3, 0, 0, 0	User Def. 1	Standard
Fine Detail	4, 1, 1, 0, 0, 0	User Def. 2	Standard
Neutral	0, 2, 2, 0, 0, 0	User Def. 3	Standard
INFO Detail set.	SET OK	INFO Detail set.	SET OK

	Sharpness	
		Strength
		Fineness
		Threshold
	Contrast	
	Saturation	
	Color tone	
	Filter effect (Monochrome)	
	Toning effect (Monochrome)	

Caution

- For movie recording, "**, *" is indicated for the [Fineness] and [Threshold] parameters of [Sharpness]. [Fineness] and [Threshold] cannot be set for movie recording.

Picture Style Customization

 [Settings and Effects](#)

  [Monochrome Adjustment](#)

You can customize any Picture Style by changing it from the default settings. For details on customizing **[Monochrome]**, see  [Monochrome Adjustment](#).

1. Select : Picture Style.

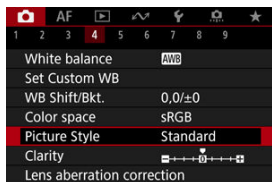

2. Select a Picture Style.



- Select the Picture Style to adjust, then press the < **INFO** > button.

3. Select an option.



- Select an option, then press < **SET** >.
- For details on settings and effects, see [Settings and Effects](#).

4. Set the effect level.



- Adjust the effect level, then press < **SET** >.









- Press the < **MENU** > button to save the adjusted setting and return to the Picture Style selection screen.
- Any settings you change from default values are displayed in blue.

 **Note**

- For movie recording, [Fineness] and [Threshold] for [Sharpness] cannot be set (not displayed).
- By selecting [Default set.] in step 3, you can restore the parameter settings of the respective Picture Style to the defaults.
- To shoot with the Picture Style you adjusted, first select the adjusted Picture Style, then shoot.

Settings and Effects

	Sharpness		
	 Strength	0: Weak outline emphasis	7: Strong outline emphasis
	 Fineness^{*1}	1: Fine	5: Grainy
	 Threshold^{*2}	1: Low	5: High
	Contrast	-4: Low contrast	+4: High contrast
	Saturation	-4: Low saturation	+4: High saturation
	Color tone	-4: Reddish skin tone	+4: Yellowish skin tone

* 1: Indicates the edge thinness that enhancement applies to. The smaller the number, the finer the outlines that can be emphasized.

* 2: Contrast threshold between edges and surrounding image areas, which determines edge enhancement. The smaller the number, the more the outline will be emphasized when the contrast difference is low. However, noise tends to be more noticeable when the number is smaller.

Filter effect

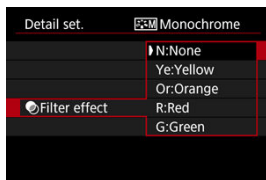

Even with the same monochrome image, you can make white clouds, green trees, or other elements stand out more by applying a filter effect.

Filter	Sample Effects
N:None	Normal black-and-white image with no filter effects.
Ye:Yellow	Blue sky will look more natural, and white clouds will look crisper.
Or:Orange	The blue sky will look slightly darker. The sunset will look more brilliant.
R:Red	The blue sky will look quite dark. Fall leaves will look crisper and brighter.
G:Green	Skin tones and lips will appear muted. Green tree leaves will look crisper and brighter.

Note

- Increasing **[Contrast]** will make the filter effect more pronounced.

Toning effect

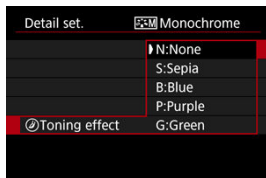

By applying a toning effect, you can create a monochrome image in the selected color. Effective when you want to create memorable images.

Picture Style Registration

You can select a base Picture Style such as **[Portrait]** or **[Landscape]**, adjust it as desired, and register it under **[User Def. 1]** – **[User Def. 3]**. Useful when creating several Picture Styles with different settings.

Picture Styles that you have registered on the camera using EOS Utility (EOS software, [🔗](#)) can also be modified here.

1. Select **[📷: Picture Style]**.

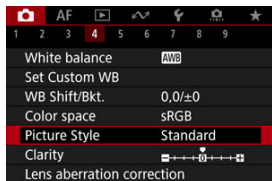

2. Select **[User Def.]**.

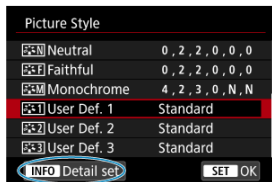

- Select **[User Def. *]**, then press the **<INFO>** button.

3. Press < [SET] >.

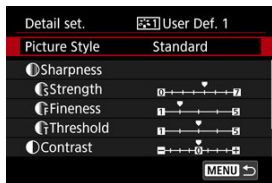

- With [Picture Style] selected, press < [SET] >.

4. Select a base Picture Style.

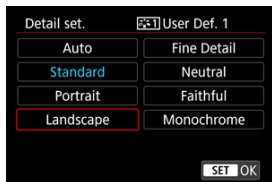

- Select the base Picture Style, then press < [SET] >.
- Also select styles this way when adjusting styles registered to the camera with EOS Utility (EOS software).

5. Select an option.

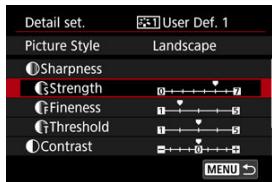

- Select an option, then press < [SET] >.

6. Set the effect level.



- Adjust the effect level, then press < **SET** >.
- For details, see [Picture Style Customization](#).

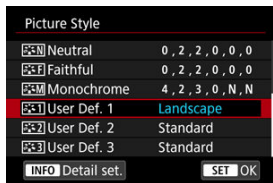

- Press the < **MENU** > button to save the adjusted setting and return to the Picture Style selection screen.
- The base Picture Style will be indicated on the right of [**User Def. ***].
- Blue style names in [**User Def. ***] have been changed from default values.

Caution

- If a Picture Style is already registered under [**User Def. ***], changing the base Picture Style will clear the parameter settings of the previously registered User Defined Picture Style.
- You can restore the default [**User Def. ***] style and settings by selecting [**Basic settings**] in [**Reset camera**].

Note

- To shoot with a registered Picture Style, select the registered [**User Def. ***], then shoot.
- For instructions on registering a Picture Style file to the camera, refer to the EOS Utility Instruction Manual.

Clarity

You can adjust image clarity, as determined by the contrast of image edges. Set toward the negative end to make images look softer or toward the positive end for a sharper appearance.

1. Select [📷: Clarity].

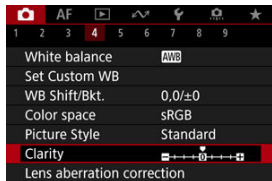

2. Set the effect level.



! Caution

- Setting clarity may darken or lighten the areas around boundaries in high-contrast images.
- The effect of this setting is not shown in images on the screen in still photo shooting.

Lens Aberration Correction

- [Peripheral Illumination Correction](#)
- [Distortion Correction](#)
- [Digital Lens Optimizer](#)
- [Chromatic Aberration Correction](#)
- [Diffraction Correction](#)

Vignetting, image distortion, and other issues may be caused by lens optical characteristics. The camera can compensate for these phenomena by using **[Lens aberration correction]**.

1. Select **[: Lens aberration correction]**.

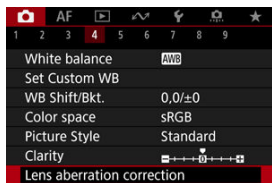

2. Select an option.

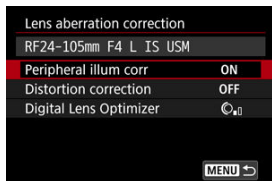

3. Select a setting.

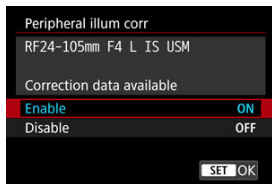

- Confirm that the name of the attached lens and [**Correction data available**] are displayed.
- If [**Correction data not available**] or [] is displayed, see [Digital Lens Optimizer](#).

Peripheral Illumination Correction

Vignetting (dark image corners) can be corrected.

⚠ Caution

- Depending on shooting conditions, noise may appear on the image periphery.
- The higher the ISO speed, the lower the amount of correction will be.

📄 Note

- The amount of correction applied will be lower than the maximum correction amount applied with Digital Photo Professional (EOS software).

Distortion Correction

Distortion (image warping) can be corrected.



Caution

- To correct distortion, the camera captures a narrower image area than the area seen in viewfinder shooting, which crops the image a little and slightly lowers the apparent resolution.
- Applying distortion correction may change the angle of view slightly.
- The amount of image cropped may vary between still photos and movies.



Note

- With RF lenses, distortion correction during movie recording is supported.

Digital Lens Optimizer

Various aberrations from lens optical characteristics can be corrected, along with diffraction and low-pass filter-induced loss of resolution.

If **[Correction data not available]** or  is displayed by **[Digital Lens Optimizer]**, you can use EOS Utility to add the lens correction data to the camera. For details, refer to the EOS Utility Instruction Manual.

Caution

- Image processing after you shoot takes longer when set to **[High]** (which causes the access lamp to be illuminated longer).
- Maximum burst is lower with **[High]**. Image recording to the card also takes longer.
- Depending on shooting conditions, noise may be intensified together with the effects of correction. Image edges may also be emphasized. Adjust Picture Style sharpness or set **[Digital Lens Optimizer]** to **[Disable]** as needed before shooting.
- The higher the ISO speed, the lower the amount of correction will be.
- For movie recording, **[Digital Lens Optimizer]** will not appear. (Correction is not possible.)
- The effect of Digital Lens Optimizer cannot be checked on the screen at the time of shooting.

Note

- With **[Digital Lens Optimizer]** set to **[Standard]** or **[High]**, **[Chromatic aberr corr]** and **[Diffraction correction]** are not displayed, but they are both set to **[Enable]** for shooting.

Chromatic Aberration Correction

Chromatic aberration (color fringing around subjects) can be corrected.



Note

- [Chromatic aberr corr] is not displayed when [Digital Lens Optimizer] is set to [Standard] or [High].

Diffraction Correction

Diffraction (loss of sharpness caused by the aperture) can be corrected.

Caution

- Depending on shooting conditions, noise may be intensified together with the effects of correction.
- The higher the ISO speed, the lower the amount of correction will be.

Note

- "Diffraction correction" corrects degraded resolution not only from diffraction but also from the low-pass filter and other factors. Thus, correction is also effective for exposures with the aperture wide open.
- **[Diffraction correction]** is not displayed when **[Digital Lens Optimizer]** is set to **[Standard]** or **[High]**.

Caution

General precautions for lens aberration correction

- Lens aberration correction cannot be applied to existing JPEG/HEIF images.
- When using a non-Canon lens, setting the corrections to **[Disable]** is recommended even if **[Correction data available]** is displayed.
- Magnifying the periphery of the image may display parts of the image that will not be recorded.
- The amount of correction (except diffraction correction) is less for lenses that do not provide distance information.

 **Note****General notes for lens aberration correction**

- Effects of lens aberration correction vary by lens and shooting conditions. Also, the effect may be difficult to discern depending on the lens used, shooting conditions, etc.
- If the correction is difficult to discern, magnifying and checking the image after shooting is recommended.
- Corrections are applied even when an extender or life-size converter is attached.
- If the correction data for the attached lens is not registered to the camera, the result will be the same as when the correction is set to **[Disable]** (except for diffraction correction).
- If necessary, refer to the EOS Utility Instruction Manual as well.

Long Exposure Noise Reduction

Noise such as dots of light or banding that tends to occur in long exposures at shutter speeds of one sec. or slower can be reduced.

1. Select [📷: Long exp. noise reduction].

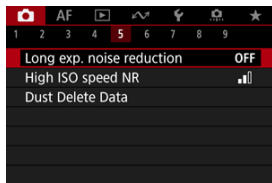

2. Set a reduction option.

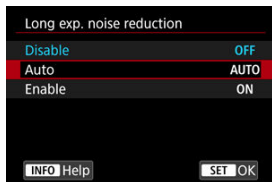

- **Auto**
For images exposed for 1 sec. or longer, noise reduction is performed automatically if noise typical of long exposures is detected. This setting is effective enough in most cases.
- **Enable**
Noise reduction is performed for all images exposed for 1 sec. or longer. The [Enable] setting may reduce noise that cannot be detected with the [Auto] setting.

 Caution

- With **[Auto]** or **[Enable]** set, noise reduction after you shoot may take as long as exposure for the shot.
- Images may look grainier with the **[Enable]** setting than with the **[Disable]** or **[Auto]** setting.
- **[BUSY]** is displayed as noise is reduced, and the shooting screen is not displayed until processing is finished, when you can shoot again.

High ISO Speed Noise Reduction

You can reduce the image noise generated. This function is especially effective when shooting at high ISO speeds. When shooting at low ISO speeds, the noise in the darker parts of the image (shadow areas) can further be reduced.

1. Select [📷: High ISO speed NR].

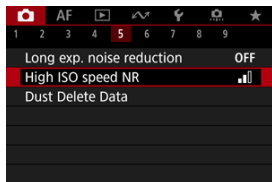

2. Set the level.



- **Low / Standard / High**
The camera applies an amount of noise reduction corresponding to your specified level.
- **Multi Shot Noise Reduction**
Applies noise reduction with higher image quality than [High]. For a single photo, four shots are taken continuously and aligned and merged automatically into a single JPEG image.
Note that [Multi Shot Noise Reduction] is not available with image quality set to RAW or RAW+JPEG.

 Caution

Precautions on Multi Shot Noise Reduction

- If there is significant misalignment in the image due to camera shake, the noise reduction effect may become smaller.
- Be careful about camera shake in handheld shots. Using a tripod is recommended.
- If you shoot a moving subject, the moving subject may leave afterimages.
- Auto image alignment may not function properly with repetitive patterns (lattice, stripes, etc.) or flat, single-tone images.
- If the subject's brightness changes as the four consecutive shots are taken, irregular exposure in the image may result.
- After shooting, it may take some time to record an image to the card after performing noise reduction and merging the images. "BUSY" is displayed as images are processed, and shooting is not possible until processing is finished.
- **[Multi Shot Noise Reduction]** is not available when any of these features are set: bulb exposures, AEB or WB bracketing, RAW or RAW+JPEG, long exposure noise reduction, multiple exposures, HDR mode, HDR PQ, or focus bracketing.
- Flash photography is not available. Note that the AF-assist beam of Speedlites may be fired, depending on the **[AF: AF-assist beam firing]** setting.
- **[Multi Shot Noise Reduction]** is not available (not displayed) when recording movies.
- The camera automatically switches to **[Standard]** when RAW or RAW+JPEG image quality is set.
- The camera automatically switches to **[Standard]** if you set the power switch to **< OFF >**, replace the card, or switch to **[BULB]** mode or movie recording.

Dust Delete Data Acquisition

 [Preparation](#)

 [Dust Delete Data Appending](#)

Dust Delete Data used to erase dust spots can be appended to images in case sensor cleaning leaves dust on the sensor. The Dust Delete Data is used by Digital Photo Professional (EOS software) to erase the dust spots automatically.

Preparation

- Use an RF or EF lens.
- Prepare a solid white object such as a sheet of paper.
- Set the lens focal length to 50 mm or longer.
- Set the lens's focus mode switch to <MF> and set the focus to infinity (∞). If the lens has no distance scale, rotate the camera to face toward you and turn the focusing ring clockwise all the way.

1. Select [: Dust Delete Data].

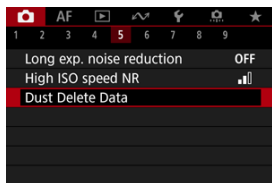

2. Select [OK].

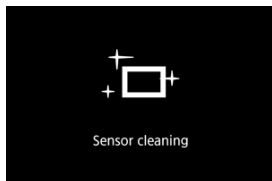
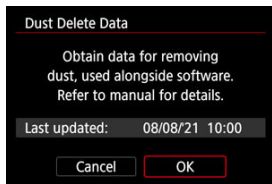

- After the automatic self-cleaning of the sensor is performed, a message will appear. Although there will be a mechanical sound of the shutter during the cleaning, no picture is taken.

3. Shoot a plain white object.

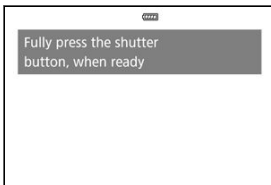

- Shoot with a plain white object (such as a new sheet of white paper) filling the screen, at a distance of 20–30 cm (0.7–1.0 ft.).
- Since the image will not be saved, the data can still be obtained even if there is no card in the camera.

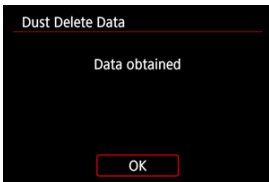

- When the picture is taken, the camera will start collecting the Dust Delete Data. When the Dust Delete Data is obtained, a message will appear.
- If the data is not obtained successfully, an error message will appear. Check the information in [Preparation](#), select **[OK]**, and shoot again.

Dust Delete Data Appending

The camera will append the Dust Delete Data obtained to all shots from now on. Acquiring Dust Delete Data before shooting is recommended.

For details about using Digital Photo Professional (EOS software) to erase dust spots automatically, refer to the Digital Photo Professional Instruction Manual.

File size is essentially unaffected by Dust Delete Data appended to images.

Caution

- Dust Delete Data is not obtained when RF-S or EF-S lenses are used, or when  **Cropping/aspect ratio** is set to **[1.6x (crop)]**.
- Dust Delete Data is not added to images when **[Distortion correction]** is set to **[Enable]**.
- If the object has any pattern or design, it may be recognized as dust data and affect the accuracy of the dust deletion with the Digital Photo Professional (EOS software).

Multiple Exposures

[☑ Merging Multiple Exposures with a JPEG Image Recorded on the Card](#)

[☑ Checking and Deleting Multiple Exposures During Shooting](#)

As you shoot multiple exposures (2–9), you can see how the images will be merged into a single image.

1. Select [: Multiple exposure].

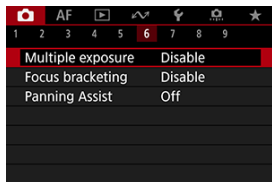

2. Set [Multiple exposure].

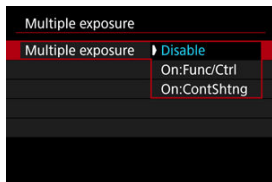

- Select an option, then press < (SET) >.
- To exit shooting multiple exposures, select **[Disable]**.

- **On:Func/Ctrl**
Convenient when shooting multiple exposures gradually as you check the results. During continuous shooting, the continuous shooting speed will decrease greatly.

- **On:ContShtng**
Used for continuous multiple exposures of moving subjects. Continuous shooting is possible, but the following operations are disabled during shooting: menu screen viewing, image review after capture, image playback, and undo last image (⌫).
Note that the single exposures used for merging are discarded, and only the multiple-exposure image is saved.

3. Set [Multi-expos ctrl].

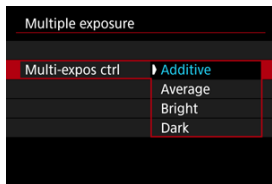

- Select a merging option, then press < (SET) >.

- **Additive**

The exposure of each single image captured is added cumulatively. Based on [**No. of exposures**], set negative exposure compensation. Follow these basic guidelines to set the exposure compensation amount.

Exposure compensation setting guidelines, by number of exposures

Two exposures: -1 stop, three exposures: -1.5 stops, four exposures: -2 stops

- **Average**

Based on the [**No. of exposures**], negative exposure compensation is set automatically as you shoot multiple exposures. If you shoot multiple exposures of the same scene, the exposure of the subject's background will be automatically controlled to obtain the standard exposure.

- **Bright/Dark**

Brightness (or darkness) of the base image and added images is compared at the same position, and bright (or dark) portions are retained. Some overlapping colors may be mixed, depending on the relative brightness (or darkness) of the images.

4. Set [No. of exposures].



- Select the number of exposures, then press < **SET** >.

5. Specify the images to save.

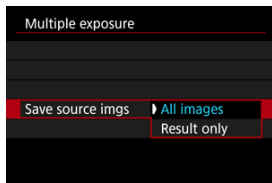

- To save all single exposures and the multiple-exposure image, select **[All images]** and press < **SET** >.
- To save only the multiple-exposure image, select **[Result only]** and press < **SET** >.

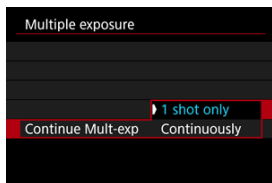

6. Set [Continue Mult-exp].



- Select an option, then press < (SET) >.
- With **[1 shot only]**, multiple-exposure shooting will be canceled automatically after the shooting ends.
- With **[Continuously]**, multiple-exposure shooting continues until the setting in step 2 is set to **[Disable]**.

7. Shoot the first exposure.



- When **[On:Func/Ctrl]** is set, the captured image will be displayed.
- The  icon blinks.
- The number of remaining exposures is indicated on the screen (1) for reference.
- Pressing the <  > button enables you to view the captured image ().

8. Shoot the next exposures.

- Images captured so far are displayed merged. For only image display, press the < INFO > button repeatedly.
- Multiple-exposure shooting will end when the set number of exposures are taken.



Note

- With [On:Func/Ctrl], you can press the < [▶] > button to view the multiple-exposure image so far or delete the previous single exposure (🔗).
- As shooting information, the multiple-exposure image has information captured for the last shot.



Caution

- Image noise, color shift, or banding may be noticeable in multiple exposures, depending on subjects and shooting conditions.
- With multiple exposures, the more exposures there are, the more noticeable the noise, irregular colors, and banding will be.
- Multiple-exposure shooting is canceled if you set the power switch to < OFF > or switch batteries or cards.
- Multiple-exposure shooting ends if you switch to [C1p]/[C2p]/[C3p]/[P] shooting modes.
- If you connect the camera to a computer, multiple-exposure shooting will not be possible. If you connect the camera to a computer during shooting, multiple-exposure shooting will end.



Merging Multiple Exposures with a JPEG Image Recorded on the Card

You can select a JPEG image recorded on the card as the first single exposure. The selected JPEG image will remain intact.

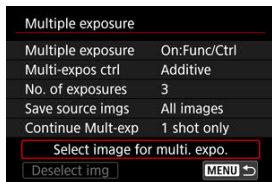
1. Select [Select image for multi. expo.].



2. Select the first image.

- Turn the <  > dial to select the first image, then press <  >.
- Select [OK].
- The file number of the selected image will be displayed at the bottom of the screen.

3. Take the picture.

- When you select the first image, the number of remaining exposures as set with **[No. of exposures]** will decrease by 1.

Images you can select

You can select a JPEG image shot at the same angle of view as the first selected JPEG.

- **Images captured at a full-frame angle of view**

Images shot with an RF or EF lens and **[Camera: Camera Cropping/aspect ratio]** set to **[Full-frame]**

- **Images captured at an APS-C angle of view**

Images shot with an RF or EF lens and **[Camera: Camera Cropping/aspect ratio]** set to **[1.6x (crop)]**, or images shot with an RF-S or EF-S lens

Caution

- The following images cannot be selected.
 - RAW or HEIF images
 - JPEG images in **M / S1 / S2** sizes
 - Images with **[Camera: Camera Cropping/aspect ratio]** set to an option other than **[Full-frame]** or **[1.6x (crop)]**
 - Images from other cameras
- Images that cannot be merged may be displayed.

Note



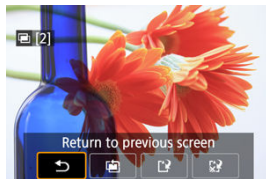

- You can also select a JPEG image used in multiple-exposure shooting.
- Select **[Deselect img]** to cancel image selection.
- The color space set for the first image also applies to subsequent images.

Checking and Deleting Multiple Exposures During Shooting



To view the multiple-exposure image so far, check exposure, and see how the images are merged, you can press the <  > button before you finish shooting your specified number of exposures (when [On:Func/Ctrl] is set, but not with [On:ContShtnng]).

Pressing the <  > button will display the operations possible during multiple-exposure shooting.



Option	Description
 Return to previous screen	The screen before you pressed the <  > button will reappear.
 Undo last image	Deletes the last image you shot (enabling you to replace it by shooting again). The number of remaining exposures will increase by 1.
 Save and exit	With [Save source imgs: All images], saves all single exposures and the multiple-exposure image created so far and exits multiple-exposure shooting. With [Save source imgs: Result only], saves only the multiple-exposure image created so far and exits multiple-exposure shooting.
 Exit without saving	Exits the multiple-exposure shooting without saving the image.

Caution

- During multiple-exposure shooting, you can only play back multiple-exposure images.

? FAQ

- **Are there any restrictions on the image quality?**

Multiple exposures are captured as JPEG [L :  8] images. Even when [📷: **Img type/size**] is set to RAW only, these images are captured as JPEG [L :  8] images.

- **Can I merge images recorded on the card?**

With [**Select image for multi. expo.**], you can select the first single exposure from the images recorded on the card (). Note that you cannot merge multiple images already recorded on the card.

- **How are multiple-exposure files numbered?**

With the camera set to save all images, multiple-exposure image files are named with the next number after the number of the last single exposure used to create them.

- **Will auto power off take effect during multiple-exposure shooting?**

During multiple-exposure shooting, auto power off will not take effect. Note that before you start multiple-exposure shooting, auto power off automatically takes effect at the time set in the [**Auto power off**] option of [: **Power saving**], which will cancel multiple-exposure shooting.

Focus Bracketing

Focus bracketing enables continuous shooting with the focal distance changed automatically after each shot. These images enable you to create a single image in focus over a deep depth of field. Compositing is also possible using an application that supports depth compositing, such as Digital Photo Professional (EOS software).

1. Select [📷: Focus bracketing].

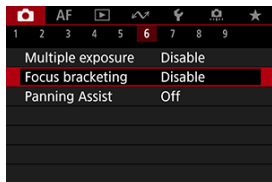

2. Set [Focus bracketing].

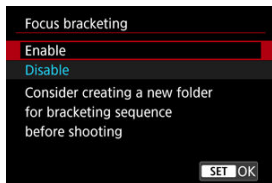

- Select [Enable].

3. Set [Number of shots].



- Specify the number of images captured per shot.
- Can be set in a range of [2]–[999].

4. Set [Focus increment].

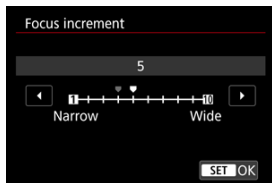

- Specify how much to shift the focus. This amount is automatically adjusted to suit the aperture value at the time of shooting. Larger aperture values increase the focus shift and make focus bracketing cover a wider range under the same focus increment and number of shots.
- After completing the settings, press <SET> >.

5. Set [Exposure smoothing].

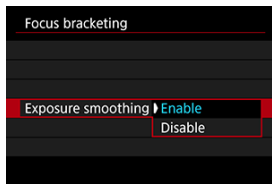

- You can compensate for changes in image brightness during focus bracketing by selecting **[Enable]**, so that the camera makes adjustments based on differences between the displayed and actual aperture value (effective f/number), which varies by focal position.
- Select **[Disable]** if you prefer not to compensate for changes in image brightness during focus bracketing. Use this option for purposes other than depth compositing of the captured images in applications such as DPP.

6. Set [Depth composite].

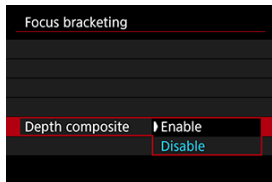

- Select **[Enable]** for in-camera depth compositing. Both the depth-composited image and the source images are saved.
- Select **[Disable]** if you prefer not to perform in-camera depth compositing. Only captured images are saved.

7. Set [Crop depth comp.].

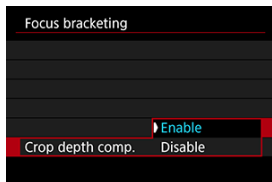

- Select [**Enable**] for cropping before compositing, to prepare any images without a sufficient angle of view for compositing alignment by cropping them to correct the angle of view.
- Select [**Disable**] if you prefer not to crop these images. In this case, areas without a sufficient angle of view are covered by a black border in the saved images. You can crop the images manually or edit them as needed.

8. Set [Flash interval].

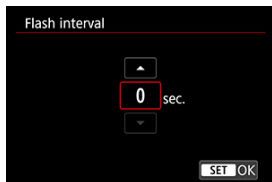



- Focus bracketing is available with compatible Speedlites, and with non-Canon flash units fired via the PC terminal.
- When set to [**0**], compatible Speedlites fire and the camera shoots as soon as the Speedlites are fully charged. Refer to the instruction manual of compatible Speedlites for precautions on continuous firing. Consider setting a longer interval when using multiple compatible Speedlites in wireless flash photography.
- With non-Canon flash units, set a suitable interval time for the flash recharging time and durability. Also refer to [Non-Canon Flash Units](#).



9. Take the picture.

- To save your shots in a new folder, tap [📁] and select [OK].
- Focus at the nearer end of your preferred focal range, then press the shutter button completely.
- Once shooting begins, release the shutter button.
- The camera shoots continuously, shifting the focal position toward infinity.
- Shooting ends after your specified number of images, or at the far end of the focal range.
- To cancel shooting, press the shutter button completely again.

Caution

- Focus bracketing is intended for still photo shooting on a tripod.
- Shooting with a wider angle of view is recommended. After depth compositing, you can crop the image if necessary.
- For details on lenses and flash units compatible with this feature, visit the Canon website .
- Suitable **[Focus increment]** settings vary by subject. An unsuitable **[Focus increment]** setting may cause unevenness in composite images, or shooting may take more time because more shots are taken. Take some test shots to decide a suitable **[Focus increment]** setting.
- Shooting under flickering light may cause uneven images. In this case, lowering the shutter speed may give better results.
- Focus bracketing is not available when the camera is set to manual focus .
- Canceling shooting in progress may cause exposure problems in the last image. Avoid using the last image when combining the images in Digital Photo Professional.
- Maximum shutter speed with focus bracketing is 1/8000 sec.
- Depth compositing is canceled if you open the battery compartment or card slot cover, or if the remaining battery capacity becomes too low. After cancellation, composited images are not saved.
- Depth compositing may fail for patterned images (with a lattice or stripes, for example) or images that are generally flat and uniform.
- When taking several shots, start by focusing closer, then gradually focus farther away.
- Too great a distance when moving the focal position between multiple shots may cause unevenness in depth-composited images, or it may cause compositing to fail.
- Depth compositing is intended for subjects that are not moving. For this reason, shooting subjects in motion may prevent effective compositing.
- Depth compositing of images with multiple subjects may fail if your shots are composed with the subjects far apart from each other, for example.
- To cancel depth compositing in progress, press the **< INFO >** button. Cancellation discards the composited image but keeps all source images.
- In depth compositing, optimal images from the shots are selected and combined by the camera. Not all of the shots are combined to create the composite image.

Note

- Using a tripod, remote switch (sold separately, ) , or wireless remote control (sold separately, ) is recommended.
- For best results, set the aperture value in a range of f/5.6–11 before shooting.
- Details such as shutter speed, aperture value, and ISO speed are determined by conditions for the first shot.
-  **Focus bracketing** reverts to **[Disable]** when the power switch is set to **< OFF >**.

Depth compositing image quality setting and images saved

- With [📷 Rec options] in [📷: Record func+card/folder sel.] set to an option other than [Rec. separately]













		Source Images* ¹	Composited Image
Image Quality	Only RAW (CRAW)	RAW	JPEG/HEIF* ²
	Only JPEG/HEIF* ³	JPEG/HEIF	JPEG/HEIF
	RAW (CRAW) + JPEG/HEIF* ³	RAW (CRAW) + JPEG/HEIF	JPEG/HEIF

- With [📷 Rec options] in [📷: Record func+card/folder sel.] set to [Rec. separately]

Image Quality	Slot 1	Slot 2	Source Images* ¹		Composited Image	
			Slot 1	Slot 2	Slot 1	Slot 2
		RAW (CRAW)		RAW (CRAW)		JPEG/HEIF* ²
	RAW (CRAW)	Only JPEG/HEIF* ³	RAW (CRAW)	JPEG/HEIF	JPEG/HEIF* ²	JPEG/HEIF
	Only JPEG/HEIF* ³	RAW (CRAW)	JPEG/HEIF	RAW (CRAW)	JPEG/HEIF	JPEG/HEIF* ²
	Only JPEG/HEIF* ³		JPEG/HEIF		JPEG/HEIF	

* 1 Multiple captured images

* 2 Image quality of composited images is  when set to RAW (CRAW).

* 3 / / /  image quality is not available. Settings are adjusted so that the resulting image is  for / / /  or  for / .

Note

- Composited images are saved as JPEG or HEIF images. RAW composited images are not produced.

Panning Assist

Camera shake and subject blur can be corrected when panning with compatible lenses attached. Applies to **[M]** or **[Tv]** mode.

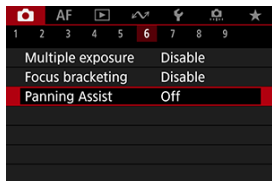

1. Select **[: Panning Assist]**.

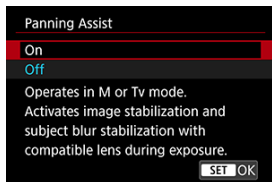

2. Select **[On]**.



Caution

- For details on lenses compatible with this feature, visit the Canon website ()
- The camera shoots in **[Electronic]** shutter mode.
- Maximum continuous shooting speed is approx. 7.5 shots/sec.
- An icon () appears in the upper left of the shooting screen when this feature is enabled.
- Flash photography is not available.
- Although lens IS is applied to images captured with lenses compatible with this feature, the effect is not shown on the screen as you shoot. (IS and subject blur correction are activated when you shoot, regardless of the lens IS setting.)
- The following subjects or shooting conditions may prevent suitable subject blur correction with lenses compatible with this feature.
 - Subjects with very low contrast
 - Subjects in low light
 - Strongly backlit or reflective subjects
 - Subjects with repetitive patterns
 - Subjects with few patterns, or with monotone patterns
 - Subjects with reflections (such as images reflected in glass)
 - Subjects smaller than the Flexible Zone AF frame
 - Multiple subjects in an AF point or frame
 - Subjects moving in irregular directions or at irregular speeds
 - Subjects that sometimes move erratically (such as runners who move up and down as they run)
 - Subjects with significant changes in speed (such as immediately after initial movement, or when moving along a curve)
 - When the camera moves too quickly or slowly
 - When camera movement does not match subject movement
- Use of this feature may increase noise in the image area. Note that the noise will not appear in captured images.
- When this feature is enabled, **[Register/recall shooting func]** () is not available, even if you press the button assigned to **[Register/recall shooting func]**.

Interval Timer Shooting

With the interval timer, you can set the shooting interval and number of shots, so that the camera takes individual shots repeatedly according to your interval until your specified number of shots are taken.

1. Select [📷: Interval timer].

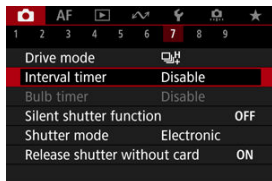

2. Select [Enable].

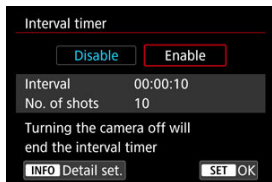

- Select [Enable], then press the <INFO> button.

3. Set the shooting interval and number of shots.

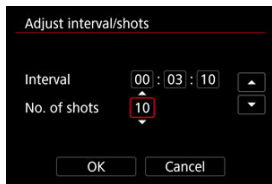

- Select an option to set (hours : minutes : seconds / number of shots).
- Press < **SET** > to display [**↑**].
- Set the desired number, then press < **SET** >. (Returns to [**□**].)
- **Interval**
Can be set in a range of [00:00:01]–[99:59:59].
- **No. of shots**
Can be set in a range of [01]–[99]. To keep the interval timer on indefinitely until you stop it, set [00].

4. Select [OK].

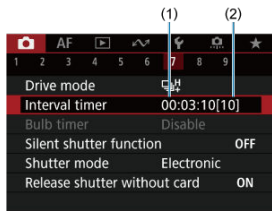

- The interval timer settings will be displayed on the menu screen.
(1) Interval
(2) Number of shots

5. Take the picture.

- First shot is taken and shooting continues according to the interval timer settings.
- During interval timer shooting, **[TIMER]** will blink.
- After the set number of shots are taken, the interval timer shooting will stop and be automatically canceled.



Note

- Using a tripod is recommended.
- Taking test shots in advance is recommended.
- Even during interval timer shooting, you can still shoot as usual by pressing the shutter button completely. Note that the camera will prepare for the next interval timer shot approx. 5 sec. in advance, which will temporarily prevent operations such as adjusting shooting settings, accessing menus, and playing back images.
- If the next scheduled interval timer shot is not possible because the camera is shooting or processing images, it will be skipped. For this reason, fewer shots than specified will be taken.
- Even during interval timer operation, auto power off is triggered after approx. 8 sec. of inactivity, as long as **[Auto power off]** under **[P: Power saving]** is not set to **[Disable]**.
- Can also be combined with AEB, white balance bracketing, multiple exposures, and HDR mode.
- To stop interval timer shooting, select **[Disable]** or set the power switch to **<OFF>**.

Caution

- Do not point the camera toward an intense light source, such as the sun or an intense artificial light source. Doing so may damage the image sensor or the camera's internal components.
- With the lens's focus mode switch set to < AF >, the camera will shoot even when autofocusing is not possible. Consider setting the mode to < MF > and focusing manually before shooting.
- If the shooting time is long, using the household power outlet accessories (sold separately) is recommended.
- Shooting long exposures or using shutter speeds longer than the shooting interval will prevent shooting at the specified interval. For this reason, fewer shots than specified will be taken. Using shutter speeds nearly the same as the shooting interval may also reduce the number of shots.
- If the time it takes to record to the card exceeds the shooting interval due to the shooting functions set or card performance, some of the shots may not be taken with the set intervals.
- When using flash with interval timer shooting, set an interval longer than the flash charge time. Intervals that are too short may prevent the flash from firing.
- Intervals that are too short may prevent shooting or autofocusing.
- Interval timer shooting is canceled and reset to **[Disable]** if you set the power switch to < OFF >, activate **[BULB]**, **[C1P]**, **[C2P]**, **[C3P]**, or **[P]** shooting mode, or use EOS Utility (EOS software).
- During interval timer shooting, you cannot use [Remote Control Shooting](#) or remote-release shooting with a Speedlite.

Silent Shutter Function

Disables shutter release sounds, operating sounds, and firing and illumination of the flash and other light sources.

The following settings are used and cannot be changed.

- Shutter mode: **[Electronic]**
- Shutter release sound, focused beep: only headphone output
- Touch sounds, self-timer sounds: silent
- Shutter at shutdown: open
- Long exposure noise reduction: **[Disable]**
- Flash firing: **[Disable]**
- AF-assist beam firing: **[Disable]**
- Self-timer/remote control lamp: not illuminated

When using lenses equipped with focus preset, consider turning off the focus preset beep.

1. Select [: Silent shutter function].

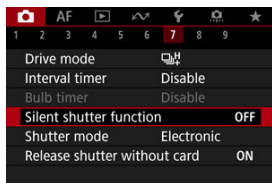

2. Select [On].

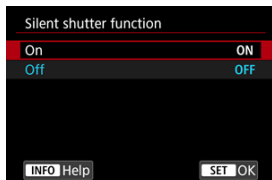

Shutter Mode

You can choose the method of shutter release.

1. Select [📷: Shutter mode].

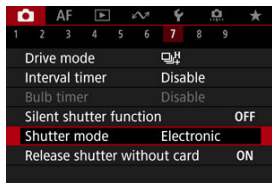

2. Select an option.

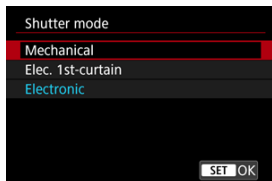

- **Mechanical**
Shooting activates the mechanical shutter.
- **Elec. 1st-curtain**
Shooting only activates the second-curtain shutter.
- **Electronic**
Enables reduced sound and vibration from shutter operations, compared to mechanical shutter or electronic first-curtain.
 - A white frame is displayed when you press the shutter button halfway.
 - Shutter operations are accompanied by beeps. You can disable beeping in [🔊: Beep].

Caution

- Defocused image areas may be incomplete when shooting near maximum aperture at high shutter speeds, depending on shooting conditions. If you dislike the appearance of defocused image areas, shooting as follows may give better results.
 - Shoot with an option other than **[Elec. 1st-curtain]**.
 - Lower the shutter speed.
 - Increase the aperture value.
- Setting : **Silent shutter function** to **[On]** sets the shutter mode to **[Electronic]**.
- Zooming during continuous shooting may cause changes in exposure even at the same f/number. For details, refer to the Canon website ([🌐](#)).

Precautions when set to **[Electronic]**

- The continuous shooting speed may become slower depending on the shooting conditions.
- Images of fast-moving subjects may look distorted.
- Images may lack suitable exposure if the aperture value changes in **[P]** (Program AE), **[Tv]** (Shutter-priority AE), or **[Fv]** (Flexible-priority AE) shooting.
- With some lenses and under some shooting conditions, lens focusing and aperture adjustment may be audible.
- Bands of light may be displayed and captured images may be affected by light and dark banding if you shoot with electronic shutter during flash firing by other cameras or under fluorescent lighting or other flickering light sources.
- Banding may appear in the viewfinder or on the screen if you shoot under flickering light sources.
- Some functions will be restricted, but you can return to shooting with previous settings by switching to a setting other than **[Electronic]**.
- With the following flash units, the continuous shooting speed is approx. 15 shots/sec. in  drive mode. Other flash units have a continuous shooting speed slower than approx. 15 shots/sec.
 - Speedlite EL-1 / EL-100 / 600EX II-RT / 600EX-RT / 600EX / 470EX-AI / 430EX III-RT / 270EX II / 270EX
 - Macro Twin Lite MT-26EX-RT
 - Macro Ring Lite MR-14EX II

Releasing Shutter without Card

You can set the camera not to shoot unless there is a card in the camera. The default setting is **[Enable]**.

1. Select [: Release shutter without card].

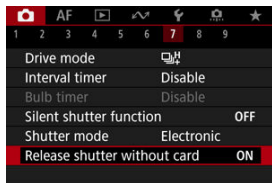

2. Select [Disable].

Image Stabilizer (IS Mode)

[Focal Length](#)

This menu is displayed for configuration of camera IS mode settings when you are using a non-IS lens. The menu is not shown when IS-equipped lenses are used. In that case, setting the lens Image Stabilizer switch to < ON > combines stabilization by the lens and camera.

1. Select [ IS (Image Stabilizer) mode].

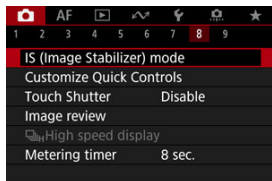

2. Select [IS mode].

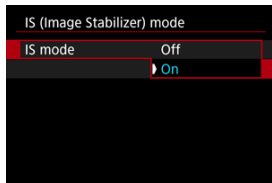

- Select [On] to use IS mode on the camera.

3. Select [Still photo IS].



- **[Always]:** Provides constant image stabilization.
- **[Only for shot]:** Image stabilization is active only at the moment of shooting.

⚠ Caution

- **[📷: IS (Image Stabilizer) mode]** is not displayed when an IS-equipped lens is attached.
- In some cases, this may not provide sufficient stabilization for certain lenses.

📄 Note

- For details on image stabilization for movie recording, see [Movie Digital IS](#).

Focal Length

Image stabilization based on your specified lens focal length is possible by setting the focal length when using lenses that do not support lens communication.

1. Select [Focal length].

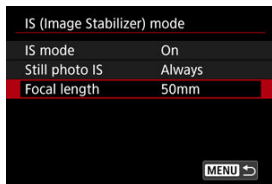

2. Set the focal length.

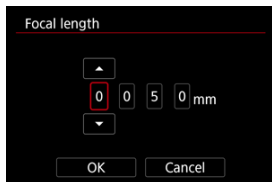

- Turn the < > dial to select the digit of the focal length.
- Press < > to display [].
- Set the desired number, then press < >. (Returns to [].)

3. Select [OK].

Caution

- Set [: Release shutter w/o lens] to [Enable]. [Disable] prevents image stabilization.
- [Focal length] is not displayed when lenses are attached that support lens communication.

Note

- Focal length can be set in a range of 1–1000 mm (in 1 mm increments).

Customizing Quick Controls

[Resetting the Custom Quick Control Screen or Clearing All Items](#)

Quick Control items and the layout are customizable.

1. Select [: Customize Quick Controls].

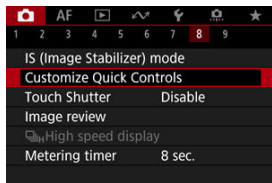

2. Select [Edit layout].

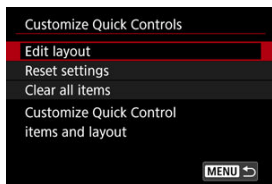

3. Select items to remove.



- Turn the $\langle \text{DIAL} \rangle$ dial or use $\langle \text{REMOVE} \rangle$ to select an item to remove, then press $\langle \text{SET} \rangle$.
- Items shown on the Quick Control screen are labeled with a checkmark. Items without a checkmark will be removed.



4. Select items to add.





- Turn the $\langle \text{DIAL} \rangle$ dial or use $\langle \text{ADD} \rangle$ to select an item to add, then press $\langle \text{SET} \rangle$.
- To change the layout, press the $\langle \text{INFO} \rangle$ button.

5. Change the layout.



- Use the <  > dial to select an item to move, then press <  >.



- Use the <  > dial to move the item, then press <  >.
- Press the < MENU > button to exit setup.

6. Select [Save and exit].

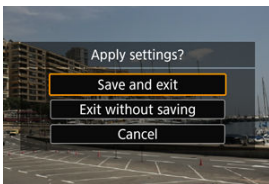

7. Review the screen.



- Press the < Q > button to check the screen with your settings applied.

Resetting the Custom Quick Control Screen or Clearing All Items

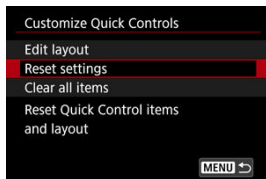

- Select [**Reset settings**] to restore the default Quick Control screen items and layout.
- Select [**Clear all items**] to remove all items from the layout, so that no Quick Control screen is displayed when the < Q > button is pressed.

Shooting with the Touch Shutter

Just by tapping the screen, you can focus and take the picture automatically.

1. Enable the Touch Shutter.



- Tap [Touch Shutter] in the lower left of the screen.
- Each time you tap the icon, it will toggle between [Touch Shutter: Enable] and [Touch Shutter: Disable].
- [Touch Shutter: Enable]
The camera will focus on the spot you tap, then the picture will be taken.
- [Touch Shutter: Disable]
You can tap a spot to perform focusing on the spot. Press the shutter button completely to take the picture.

2. Tap the screen to shoot.



- Tap the face or subject on the screen.
- On the point you tap, the camera focuses (Touch AF) using your specified [AF Area](#).
- When [C] is set, the AF point turns green when focus is achieved, then the picture is taken automatically.
- If focus is not achieved, the AF point turns orange and the picture cannot be taken. Tap the face or subject on the screen again.

! Caution

- The camera shoots in single shooting mode regardless of the drive mode setting ([S], [H], or [R]).
- Tapping the screen focuses with [One-Shot AF], even if [AF: AF operation] is set to [Servo AF].
- Tapping the screen in magnified view will not focus or take the picture.
- When shooting by tapping with [Review duration] in [Image review] set to [Hold], you can take the next shot by pressing the shutter button halfway or tapping [Return].

📱 Note

- To shoot with bulb exposure, tap the screen twice. Tap once to start exposure and again to stop it. Be careful not to shake the camera when tapping the screen.

Image Review

[Review Duration](#)

[Viewfinder Display](#)

Review Duration

To keep the image displayed immediately after you shoot, set to **[Hold]**, and if you prefer not to have the image displayed, set to **[Off]**.

1. Select **[: Image review]**.



2. Select **[Review duration]**.

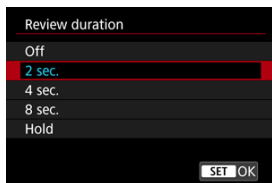

3. Set a time option.



Note

- When **[Hold]** is set, images are displayed as long as the time set in the **[Screen off]** option of **[🔋: Power saving]**.

Viewfinder Display

Set to **[Enable]** for viewfinder display of your shots immediately after you shoot.

1. Select **[Image review]**.



2. Select **[Viewfinder display]**.

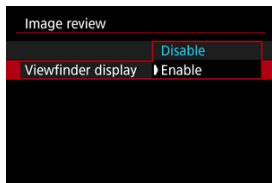

3. Select an option.

Note

- **[Viewfinder display]** settings take effect when **[Image review]** is set to an option other than **[Off]**.

High-Speed Display

High-speed display that switches between each shot and the live image is available when shooting in [H] (high-speed continuous shooting) drive mode and in a shutter mode other than electronic shutter.

1. Select [H]: [H]High speed display].

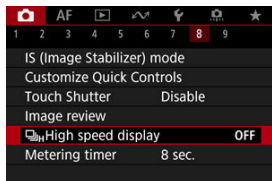

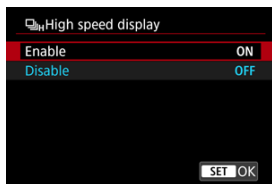

2. Select an option.



- Select [Enable] for display that switches between each shot and the live image.

 **Caution**

- Images may waver or flicker during high-speed display. This occurs more often at high shutter speeds. However, this does not affect shooting results.
- High-speed display is not performed for shutter speeds slower than 1/30 sec., aperture values higher than f/11, conditions that make autofocus difficult, flash photography, or ISO expansion. It may also stop as you are shooting.
- High-speed display is not available in the following cases.
 - With [: **OVF sim. view assist**] set to [**On**]
 - With [: **Display simulation**] set to [**Disable**] or [**Exposure only during**  **DOF**]

Metering Timer

You can set how long the metering timer runs (which determines the duration of exposure value display/AE lock) after it is triggered by an action such as pressing the shutter button halfway.

1. Select [📷: Metering timer].
2. Set a time option.

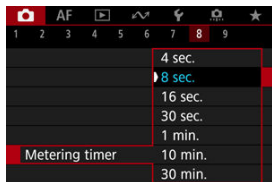

Display Simulation

With display simulation, display of image brightness and depth of field more closely matches the actual brightness (exposure) of your shots.

1. Select [📷: Display simulation].

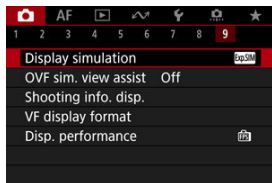

2. Select an option.

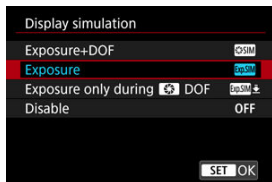



- **Exposure+DOF** (Exp.SIM)
Image brightness and depth of field as displayed closely matches the actual brightness (exposure) of your shots. If you set exposure compensation, the image brightness will change accordingly. Similarly, changes to the aperture value will alter the depth of field.
- **Exposure** (Exp.SIM)
Image brightness as displayed closely matches the actual brightness (exposure) of your shots. If you set exposure compensation, the image brightness will change accordingly.
- **Exposure only during** [📷] **DOF** (Exp.SIM) [±]
Normally, the image is displayed at standard brightness, so it is easy to see. Only when you press and hold the depth-of-field preview button will image brightness resemble actual brightness (exposure) of your shot, and you can check depth of field.

- **Disable (OFF)**

The image is displayed at standard brightness, so it is easy to see. Even if you set exposure compensation, the image is displayed at the standard brightness.

 **Caution**

Notes on [Exposure+DOF]

- Display may flicker at some shutter speeds.
- With EF lenses, this setting may increase the shutter-release time lag.
- The depth of field shown is only a guideline. For more precise indication of the depth of field, press the depth-of-field preview button.
- [Exposure+DOF] is not available with some lenses.
-  SIM blinks if either exposure or depth of field cannot be simulated, or if neither can be simulated.
-  SIM is dimmed if either exposure or depth of field simulation stops, or if both simulations stop.
- Zooming with certain lenses may change the exposure. For details, refer to the Canon website ()
- Depth-of-field previewing is canceled when you press the shutter button halfway.

Optical Viewfinder Simulation

Natural-looking viewfinder and screen display, resembling the view from an optical viewfinder, is available in still photo shooting. Note that images displayed with this feature set to **[On]** may differ from actual shooting results.

1. Select **[CAMERA]: OVF sim. view assist**.

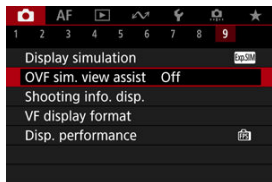

2. Select an option.

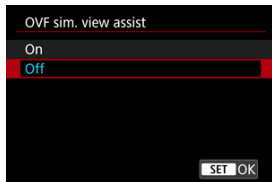

! Caution

- Setting this feature to **[On]** sets **[CAMERA: Display simulation]** to **[Disable]**.
- Optical viewfinder simulation is used for display when this feature is set to **[On]** in HDR shooting.
- Optical viewfinder simulation is not used during display to external monitors, including in display to both an external monitor and the camera screen.
- Depending on setting screens, optical viewfinder simulation may not be used for display.
- Display may not resemble an optical viewfinder in some cases.
- The display appearance may change during continuous shooting, with some combinations of drive and shutter modes.

**Note**

- Not available when the camera is set to shoot multiple exposures.

Shooting Information Display

- [Customizing Information on the Screen](#)
- [Customizing Information in the Viewfinder](#)
- [Viewfinder Vertical Display](#)
- [Grid](#)
- [Histogram](#)
- [Lens Information Display](#)
- [Vertical Exposure Level Indicator](#)
- [Flicker Detection Display](#)
- [Clearing Settings](#)

You can customize the details and screens of information shown on the screen or in the viewfinder when you shoot.

Customizing Information on the Screen

1. Select [: Shooting info. disp.].

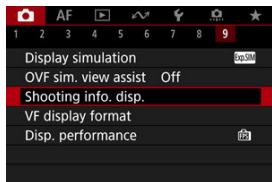

2. Select [Screen info. settings].

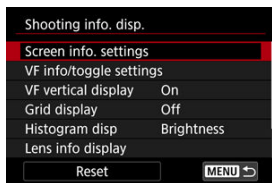

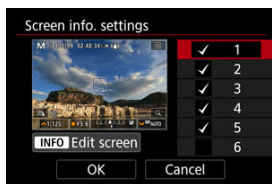

3. Select screens.



- Turn the \odot dial to select screens of information to show on the camera.
- For information you prefer not to display, press $\langle \text{SET} \rangle$ to clear the checkmark [✓].
- To edit the screen, press the $\langle \text{INFO} \rangle$ button.

4. Edit the screen.



- Turn the <  > dial to select options to show on the screen of information.
- For items you prefer not to display, press <  > to clear the checkmark [✓].
- Select [**OK**] to register the setting.

Customizing Information in the Viewfinder

1. Select []: Shooting info. disp.].

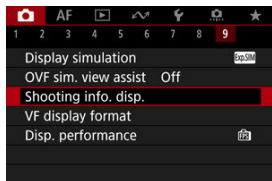

2. Select [VF info/toggle settings].

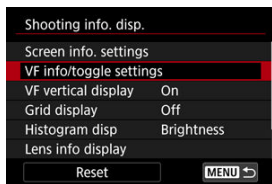



3. Select screens.

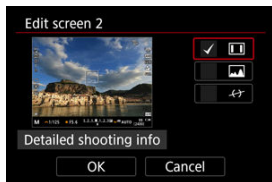

- Turn the dial to select information screens to show in the viewfinder.
- For information you prefer not to display, press to clear the checkmark [✓].
- To edit the screen, press the button.

4. Edit the screen.



- Turn the <  > dial to select options to show in the viewfinder.
- For items you prefer not to display, press <  > to clear the checkmark [✓].
- Select [OK] to register the setting.

Viewfinder Vertical Display

You can select how viewfinder information is displayed when you are shooting still photos vertically.

1. Select [**Ⓜ**: Shooting info. disp.].

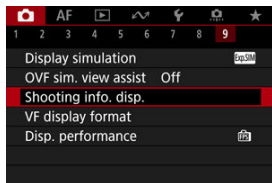

2. Select [**VF vertical display**].

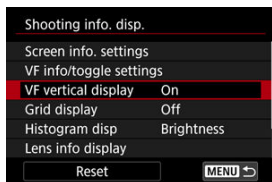

3. Select an option.

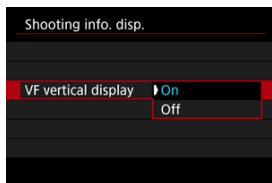

- **On**
Information is automatically rotated, making it easier to read.
- **Off**
Information is not automatically rotated.

A grid can be displayed on the screen and viewfinder.

1. Select [: Shooting info. disp.].

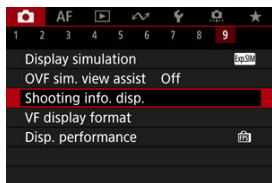

2. Select [Grid display].

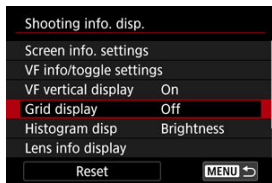

3. Select an option.



You can select the content and display size of the histogram.

1. Select [**📷**: Shooting info. disp.].

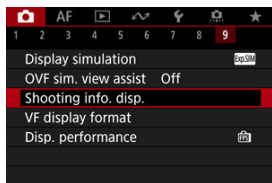

2. Select [**H**istogram disp.].

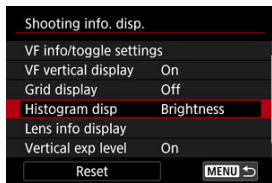

3. Select an option.

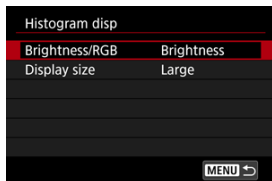

- Select the content ([**Brightness**] or [**RGB**]) and display size ([**Large**] or [**Small**]).

Lens Information Display

You can display information about the lens in use.

1. Select [: Shooting info. disp.].

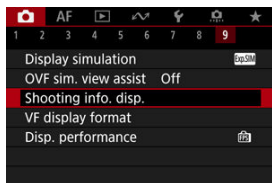

2. Select [Lens info display].

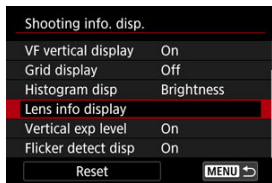

3. Select an option.

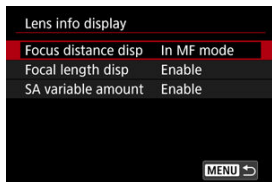

- **Focus distance disp**

You can display focus distance when using RF lenses. In focus distance display, you can select the timing and unit of measurement.

- **Focal length disp**

You can display the focal length of the lens in use.

- **SA variable amount**

You can display the amount of correction set when using lenses featuring spherical aberration control.

* SA: spherical aberration

Vertical Exposure Level Indicator

You can show or hide the vertical exposure level indicator displayed on the right side of the screen.

1. Select [CAMERA: Shooting info. disp.].

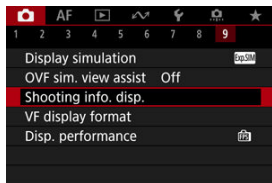

2. Select [Vertical exp level].

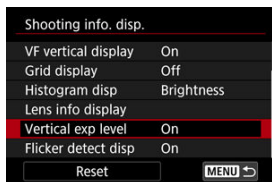

- Select [On] when using metered manual flash with an external flash unit.
- The vertical exposure level indicator is shown while the metering timer is active.

Note

- When set to [On], the metering level is shown in real time on the exposure level indicator in all shooting modes except [BULB].
- Set to [Off] if you prefer not to display the indicator.

Flicker Detection Display

You can specify whether to show the **[Flicker!]** icon in shooting information display.

1. Select **[📷: Shooting info. disp.]**.

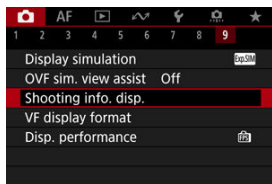

2. Select **[Flicker detect disp.]**.

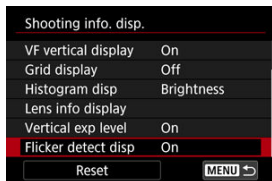

● On

The **[Flicker!]** icon is displayed under the following conditions.

- With **[📷: Anti-flicker shoot.]** set to **[Enable]**:
The **[Flicker!]** icon is illuminated when flicker is detected.
- With **[📷: Anti-flicker shoot.]** set to **[Disable]**:
The **[Flicker!]** icon blinks when flicker is detected.

● Off

The **[Flicker!]** icon is not displayed.

1. Select []: Shooting info. disp.].

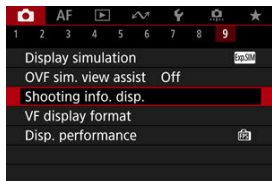

2. Select [Reset].

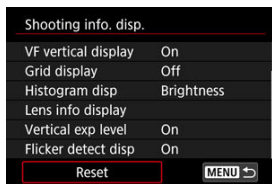

3. Select [OK].

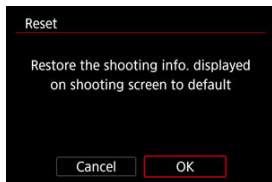

Viewfinder Display Format

You can select how information is presented in the viewfinder.

1. Select [: VF display format].

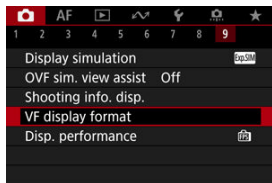

2. Select an option.

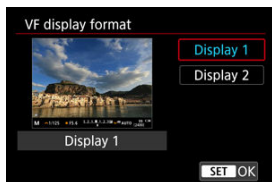

Display Performance

You can select the performance parameter to prioritize in shooting screen display for still photos.

1. Select [: Disp. performance].

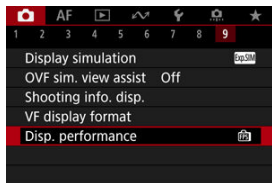

2. Select an option.

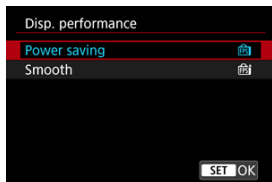

When set to [Smooth]

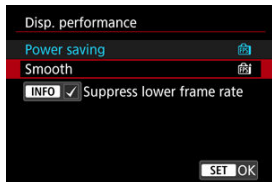

- By pressing the <INFO> button to add a checkmark, you can include low-light locations in the scenarios for suppressing lower display frame rates.

 **Caution**

- Shooting under low light with [**Suppress lower frame rate**] set for shooting screen display may affect performance as follows.
 - Faster battery consumption
 - Fewer shots available
 - Lower image display brightness
 - Difficulty in autofocusing
 - Lower metering precision
 - Lower flicker detection precision
 - Lower subject detection precision

Auto Power Off Temperature

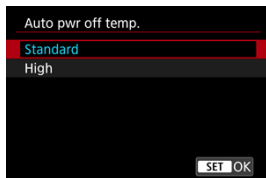

Set to **[High]** to reduce the frequency of the camera automatically turning off due to high card temperature.

Caution

- Cards may become hot when [: **Auto pwr off temp.**] is set to **[High]**. Wait until the card has cooled down before removing it.

Metering Mode Selection

You can select one of four methods to measure the subject brightness.

Setting with the < > button

1. Press the <   > button (6).

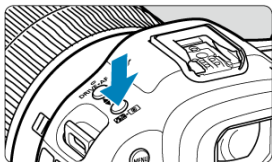

2. Select the metering mode.



- Turn the <  > dial to make a selection.

Setting with the <Q> button

1. Press the <Q> button (10).

- With an image displayed, press the <Q> button.

2. Select the metering mode.

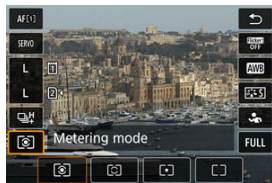

- To select an item, turn the <DIAL> dial or press <UP/DOWN> up or down.
- To select the metering mode, turn the <DIAL> or <DIAL> dial, or press <LEFT/RIGHT> left or right.

Setting via the menu

1. Select [📷: Metering mode].

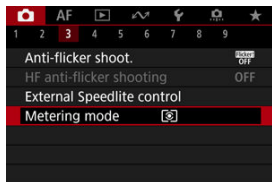

2. Select the metering mode.

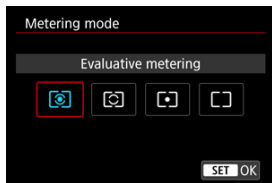

Evaluative metering

General-purpose metering mode suited even for backlit subjects. The camera adjusts the exposure automatically to suit the scene.

Partial metering

Effective where there are much brighter lights around the subject due to backlight, etc.







Spot metering

Effective when metering a specific part of the subject. The spot metering area is indicated on the screen.

Center-weighted average

The metering across the screen is averaged, with the center of the screen weighted more heavily.

Note

- By default, the camera will set the exposure as follows.
With , holding down the shutter button halfway locks the exposure value (AE lock) after the camera focuses with One-Shot AF. With //, the exposure value is set at the moment the picture is taken (without locking the exposure value when the shutter button is pressed halfway).
- With : **AE lock meter. mode after focus** () , you can set whether or not to lock the exposure (AE lock) once subjects are in focus with One-Shot AF.

Manual Exposure Compensation

Exposure compensation can brighten (increased exposure) or darken (decreased exposure) the standard exposure set by the camera.

Exposure compensation is available in **[Fv]**, **[P]**, **[Tv]**, **[Av]**, and **[M]** modes.

For details on exposure compensation when **[M]** mode and ISO Auto are both set, see [M: Manual Exposure](#), and see [Fv: Flexible-Priority AE](#) for **[Fv]** mode.

1. Check the exposure.

- Press the shutter button halfway and check the exposure level indicator.

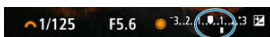

2. Set the compensation amount.

Increased exposure, to brighten images



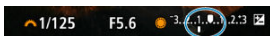

Decreased exposure, to darken images



- Set it by looking at the screen as you turn the  dial.
- A  icon is displayed to indicate exposure compensation.

3. Take the picture.

- To cancel exposure compensation, set the exposure level  to the standard exposure index (.

Caution

- If **[Auto Lighting Optimizer]** () is set to any setting other than **[Disable]**, the image may still look bright even if decreased exposure compensation is set to darken images.



Note

- The exposure compensation amount will remain in effect even after you set the power switch to <OFF>.

Exposure Lock (AE Lock)

[AE Lock Effects](#)

You can lock the exposure when you want to set the focus and exposure separately or when you will take multiple shots at the same exposure setting. Press the < * > button to lock the exposure, then recompose and take the picture. This is called AE lock. It is effective for shooting backlit subjects, etc.

1. Focus on the subject.

- Press the shutter button halfway.
- The exposure value will be displayed.

2. Press the < * > button (ⓘ).

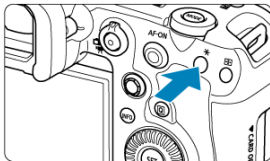

- A [] icon is displayed in the lower left of the screen to indicate that exposure is locked (AE lock).
- Each time you press the < * > button, the current exposure setting is locked.

3. Recompose and take the picture.





- When you are to take more pictures while maintaining the AE lock, keep holding down the **< * >** button and press the shutter button to take another picture.

Note

- AE lock is not possible with bulb exposures.

AE Lock Effects

Metering Mode Selection	AF Point Selection	
	Automatic Selection	Manual Selection
	Exposure centered on the AF point in focus is locked.	Exposure centered on the selected AF point is locked.
	Center-weighted exposure is locked.	

* When  is set with the lens's focus mode switch set to **< MF >**, center-weighted exposure is locked.

General Still Photo Shooting

 [Information Display](#)

 [General Still Photo Shooting Precautions](#)

Information Display

For details on the icons displayed for still photo shooting, see [Information Display](#).

Note

- White display of the **[Exp.SIM]** icon indicates that your shots will be about as bright as the image displayed.
- If the **[Exp.SIM]** icon is blinking, it indicates that the image is displayed at a brightness that differs from the actual shooting result because of low- or bright-light conditions. However, the actual image recorded will reflect the exposure setting. Note that the noise may be more noticeable than the actual image recorded.
- Display simulation may not be performed under some shooting settings. The **[Exp.SIM]** icon and histogram will be displayed in gray. The image will be displayed on the screen at the standard brightness. The histogram may not be properly displayed in low- or bright-light conditions.
- Histogram display is available when **[CAMERA: Display simulation]** is set to **[Exposure]** or **[Exposure+DOF]** .

General Still Photo Shooting Precautions

⚠ Caution

- Do not point the camera toward an intense light source, such as the sun or an intense artificial light source. Doing so may damage the image sensor or the camera's internal components.

Image quality

- When you shoot at high ISO speeds, noise (such as dots of light and banding) may become noticeable.
- Shooting in high temperatures may cause noise and irregular colors in the image.
- Frequent shooting over an extended period may cause high internal temperatures and affect image quality. When you are not shooting, always turn off the camera.
- If you shoot a long exposure while the camera's internal temperature is high, image quality may decline. Stop shooting and wait a few minutes before shooting again.

White [🔥] and red [🔥] internal temperature warning icons

- White [🔥] or red [🔥] icons indicate high internal camera temperature, caused by factors such as extended shooting or use in hot environments.
- The white [🔥] icon indicates that the image quality of still photos will decline. Stop shooting for a while and allow the camera to cool down.
- Shooting at low ISO speeds instead of high speeds is recommended when the white [🔥] icon is displayed.
- The red [🔥] icon indicates that shooting will soon be terminated automatically. Shooting will not be possible again until the camera cools down internally, so stop shooting temporarily or turn off the camera and let it cool down a while.
- Shooting in hot environments over extended periods will cause the white [🔥] or red [🔥] icon to appear sooner. When you are not shooting, always turn off the camera.
- If the camera's internal temperature is high, the quality of images shot with a high ISO speed or long exposure may decline even before the white [🔥] icon is displayed.

Shooting results

- In magnified view, the shutter speed and aperture value will be displayed in orange. If you take the picture in magnified view, the exposure may not come out as desired. Return to the normal view before taking the picture.
- Even if you take the picture in magnified view, the image will be captured with the image area of the normal view.

Images and display





- Under low- or bright-light conditions, the displayed image may not reflect the brightness of the captured image.
- Although noise may be noticeable in images under low light (even at low ISO speeds), there will be less noise in your shots, due to differences in image quality between displayed and captured images.
- The screen may flicker if the light source (lighting) changes. In this case, stop shooting temporarily and resume under the light source you will use.
- Pointing the camera at different direction may momentarily prevent correct display of brightness. Wait until the brightness level stabilizes before shooting.
- If there is a very bright light source in the image, the bright area may appear black on the screen. However, the actual captured image will correctly show the bright area.
- Under low light, bright [: **Screen brightness**] settings may cause noise or irregular colors in images. However, the noise or irregular colors will not be recorded in the captured image.
- When you magnify the image, the image sharpness may look more pronounced than in the actual image.

Lens

- If the attached lens has an Image Stabilizer and you set the Image Stabilizer switch to **< ON >**, the Image Stabilizer will operate at all times even if you do not press the shutter button halfway. The Image Stabilizer consumes battery power and may decrease the number of available shots depending on the shooting conditions. When the Image Stabilizer is not necessary, such as when using a tripod, it is recommended that you set the Image Stabilizer switch to **< OFF >**.
- With EF lenses, focus preset during shooting is only available when using (super) telephoto lenses equipped with this function released in and after the second half of 2011.



Note

- The field of view is approx. 100% (with image quality set to JPEG []).
- If the camera is idle over an extended period, the screen will turn off automatically after the time set in [**Screen off**] or [**Viewfinder off**] under [: **Power saving**]. The camera then turns off automatically after the time set in [**Auto power off**] ().
- Using a commercially available HDMI cable, you can display images on a television (). Note that no sound will be output.

Movie Recording

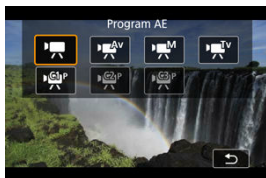

To prepare for movie recording, set the still photo shooting/movie recording switch to , then press the <MODE> button and choose a recording mode.

Caution

- When switching from still photo shooting to movie recording, check the camera settings again before recording movies.

Note

- You can record movies by pressing the movie shooting button during still photo shooting.

- [Tab Menus: Movie Recording](#)
- [Movie Recording](#)
- [Movie Recording Size](#)
- [High Frame Rate](#)
- [Movie Recording Format](#)
- [Movie Cropping](#)
- [Sound Recording](#)
- [HDR Movie Recording](#)
- [Canon Log Settings](#)
- [Time-Lapse Movies](#)
- [Movie Self-Timer](#)
- [Image Stabilizer \(IS Mode\)](#)
- [Shutter Button Function for Movies](#)
- [Zebra Settings](#)
- [Time Code](#)
- [Other Menu Functions](#)
- [General Movie Recording Precautions](#)

Tab Menus: Movie Recording

● Shooting 1

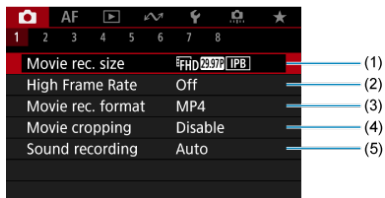

- (1) [Movie rec. size](#)
- (2) [High Frame Rate](#)
- (3) [Movie rec. format](#)
- (4) [Movie cropping](#)
- (5) [Sound recording](#)

● Shooting 2

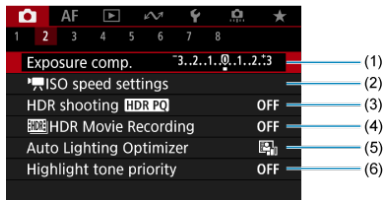

- (1) [Exposure comp.](#)
- (2) [ISO speed settings](#)
- (3) [HDR shooting HDR PQ](#)
- (4) [HDR Movie Recording](#)
- (5) [Auto Lighting Optimizer](#)
- (6) [Highlight tone priority](#)

● Shooting 3

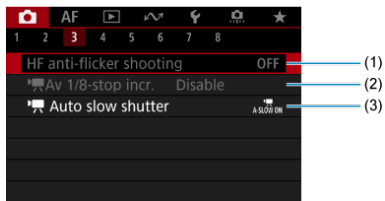

- (1) [HF anti-flicker shooting](#)
- (2) [Av 1/8-stop incr.](#)
- (3) [Auto slow shutter](#)

● Shooting 4

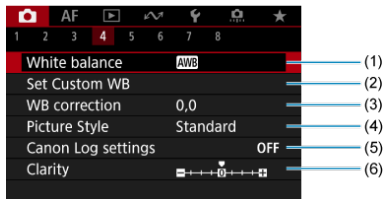

- (1) [White balance](#)
- (2) [Set Custom WB](#)
- (3) [WB correction](#)
- (4) [Picture Style](#)
 - [Picture Style Selection](#)
 - [Picture Style Customization](#)
 - [Picture Style Registration](#)
- (5) [Canon Log settings](#)
- (6) [Clarity](#)

● Shooting 5

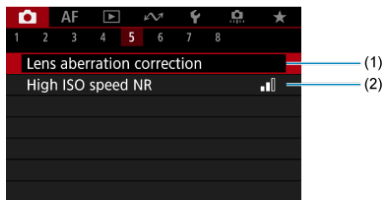

(1) [Lens aberration correction](#)

(2) [High ISO speed NR](#)

● Shooting 6

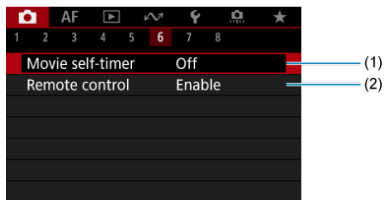

(1) [Movie self-timer](#)

(2) [Remote control](#)

● Shooting 7

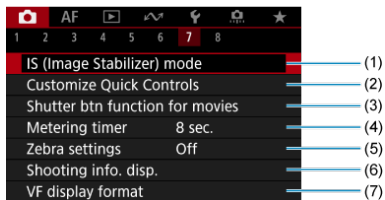

- (1) [IS \(Image Stabilizer\) mode](#)
- (2) [Customize Quick Controls](#)
- (3) [Shutter btn function for movies](#)
- (4) [Metering timer](#)
- (5) [Zebra settings](#)
- (6) [Shooting info. disp.](#)
- (7) [VF display format](#)

● Shooting 8

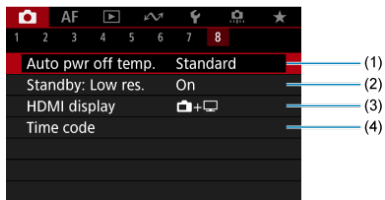

- (1) [Auto pwr off temp.](#)
- (2) [Standby: Low res.](#)
- (3) [HDMI display](#)
- (4) [Time code](#)

Movie Recording

-  [Autoexposure Recording](#)
-  [Shutter-Priority AE](#)
-  [Aperture-Priority AE](#)
- ISO Speed in [] / [] / [] Mode
-  [Manual Exposure Recording](#)
- ISO Speed in [] Mode
- [Shutter Speed](#)
- [Still Photo Shooting](#)
- [Information Display \(Movie Recording\)](#)

☑ Autoexposure Recording

Exposure is controlled automatically to suit the brightness.

1. Set the recording mode to [☑].

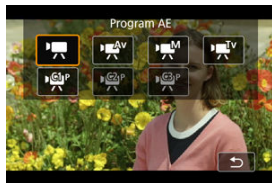

- Press the <MODE> button, then turn the <☑> dial to select [☑].

2. Focus on the subject.

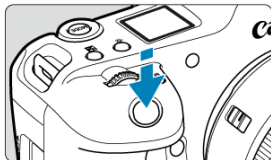

- Before recording a movie, focus with AF (☑) or manual focus (☑).
- By default, [AF: Movie Servo AF] is set to [Enable] so that the camera always keeps focusing (☑).
- When you press the shutter button halfway, the camera focuses using your specified AF area.

3. Record the movie.

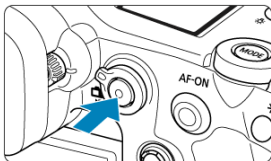

- Press the movie shooting button to start recording a movie. You can also start recording a movie by tapping [●] on the screen.



- While the movie is being recorded, the [●REC] icon (1) will be displayed in the upper right of the screen.

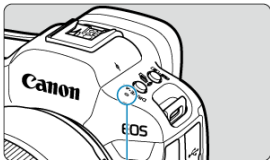



- Sound is recorded by the microphone (2).
- To stop recording, press the movie shooting button again. You can also stop recording a movie by tapping [■] on the screen.

Shutter-Priority AE

[] recording mode enables you to set your preferred shutter speed for movies. ISO speed and aperture values are set automatically to suit the brightness and obtain standard exposure.

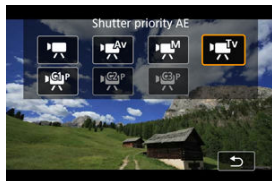
1. Set the recording mode to [].





- Press the < MODE > button, then turn the <  > dial to select [].

2. Set the shutter speed (1).



(1)

- Set it by looking at the screen as you turn the <  > dial.
- Available shutter speeds vary by frame rate ().

3. Focus and record the movie.

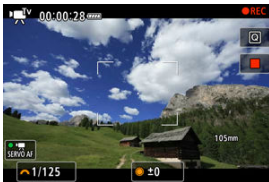

- Same as steps 2 and 3 for [Autoexposure Recording](#).

! Caution

- Avoid adjusting shutter speed while recording movies, which will record changes in exposure.
- When recording a movie of a moving subject, a shutter speed of approx. 1/25 sec. to 1/125 sec. is recommended. The faster the shutter speed, the less smooth the subject's movement will look.
- If you change the shutter speed while recording under fluorescent or LED lighting, image flicker may be recorded.

Aperture-Priority AE

[] recording mode enables you to set your preferred aperture value for movies. ISO speed and shutter speed are set automatically to suit the brightness and obtain standard exposure.

1. Set the recording mode to [].

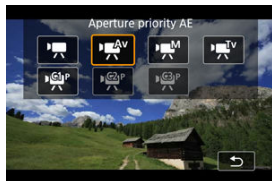

- Press the <MODE> button, then turn the < > dial to select [].

2. Set the aperture value (1).



- Set it by looking at the screen as you turn the < > dial.

3. Focus and record the movie.



- Same as steps 2 and 3 for [Autoexposure Recording](#).

! Caution

- Avoid adjusting the aperture value while recording movies, which will record changes in exposure caused by aperture adjustment.

📄 Note

Notes for [P], [Tv], and [Av] modes

- You can lock the exposure (AE lock) by pressing the < * > button. After applying AE lock during movie recording, you can cancel it by pressing the < * > button. (AE lock setting is retained until you press the < * > button.)
- Exposure compensation can be set in a range of up to ± 3 stops by turning the <  > dial.
- In [P] mode, the ISO speed, shutter speed, and aperture value are not recorded in movie Exif information.
- The camera is compatible with Speedlite functionality to activate the LED light automatically under low light when recording movies in [P], [Tv], and [Av] modes. For details, refer to the Instruction Manual of the EX series Speedlite equipped with an LED light.

ISO Speed in [P] / [Tv] / [Av] Mode



ISO speed is set automatically. See [ISO Speed in Movie Recording](#).

Manual Exposure Recording

You can manually set the shutter speed, aperture value, and ISO speed for movie recording.





1. Set the recording mode to .

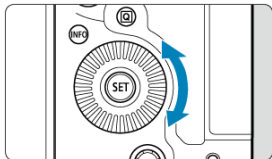
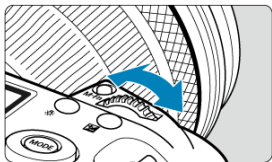

- Press the **<MODE>** button, then turn the  dial to select .

2. Set the shutter speed, aperture value, and ISO speed.



- (1)
 - (2)
 - (3)
- Press the shutter button halfway and check the exposure level indicator.
 - Turn the <  > dial to set the shutter speed (1), the <  > dial to set the aperture value (2), and the <  > dial to set the ISO speed (3).
 - Available shutter speeds vary by frame rate ().

3. Focus and record the movie.

- Same as steps 2 and 3 for [Autoexposure Recording](#).

Caution

- ISO speed cannot be expanded to L (equivalent to ISO 50) in movie recording.
- During movie recording, avoid changing the shutter speed, aperture value, or ISO speed, which may record changes in the exposure or create more noise at high ISO speeds.
- When recording a movie of a moving subject, a shutter speed of approx. 1/25 sec. to 1/125 sec. is recommended. The faster the shutter speed, the less smooth the subject's movement will look.
- If you change the shutter speed while recording under fluorescent or LED lighting, image flicker may be recorded.

Note

- Exposure compensation with ISO Auto can be set in a range of ± 3 stops.
- When ISO Auto is set, you can press the **< * >** button to lock the ISO speed. After locking the ISO speed during movie recording, you can cancel it by pressing the **< * >** button. (ISO speed lock is maintained until you press the **< * >** button.)
- If you press the **< * >** button and recompose the shot, you can see the exposure level difference on the exposure level indicator () compared to when the **< * >** button was pressed.

ISO Speed in [M] Mode

You can set the ISO speed manually or select [AUTO] to set it automatically. For details on ISO speed, see [ISO Speed in Movie Recording](#).

Shutter Speed

Available shutter speeds in [TV] and [M] mode vary depending on the frame rate of your specified movie recording quality.

Frame Rate	Shutter Speed (Sec.)		
	Normal Movie Recording	High Frame Rate Movie Recording	HDR Movie Recording
119.9P	-	1/4000-1/125	-
100.0P		1/4000-1/100	
59.94P	1/4000-1/8	-	-
50.00P			
29.97P			
25.00P			[TV] 1/4000-1/50 [M] 1/1000-1/50
24.00P			-
23.98P			

Still Photo Shooting

Still photo shooting is not supported in movie recording mode. To shoot still photos, stop recording and change the [Shooting mode] setting to still photos first.

Information Display (Movie Recording)

For details on the icons on the movie recording screen, see [Information Display](#).

Movie Recording Size

- [4K Movie Recording](#)
- [Image Area](#)
- [Cards That Can Record Movies](#)
- [Movie Files Exceeding 4 GB](#)
- [Total Movie Recording Time and File Size Per Minute](#)

You can set the recording size, frame rate, and compression method in [📷: **Movie rec. size**].

The frame rate displayed on the [📷: **Movie rec. size**] screen switches automatically depending on the [🔧: **Video system**] setting (🔗).

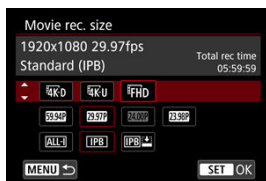

	Image Size	Aspect Ratio
4K-D	4096×2160	17:9
4K-U	3840×2160	16:9
FHD	1920×1080	16:9

⚠ Caution

- If you change the [🔧: **Video system**] setting, also set [📷: **Movie rec. size**] again.
- Other devices may not play movies such as 4K, FHD 59.94P / 50.00P, and High Frame Rate movies normally, because playback is processing-intensive.
- Apparent resolution and noise vary slightly depending on movie recording quality, cropped shooting settings, and the lens used.

 **Note**

- To obtain better performance with the card, formatting the card with the camera before recording movies is recommended (🔗).
- Movies cannot be recorded in HD or VGA quality.

4K Movie Recording



- Recording 4K movies requires a stable card with a fast writing speed. For details, see [Cards That Can Record Movies](#).
- 4K or High Frame Rate movie recording greatly increases the processing load, which may increase the internal camera temperature faster or higher than for regular movies. **If  or a red  icon appears during movie recording, the card may be hot, so stop recording the movie and let the camera cool down before removing the card. (Do not remove the card immediately.)**
- From a 4K movie, you can select any frame to save to the card as a JPEG still image (🔗).

Image Area

The movie image area varies depending on factors such as movie recording quality and cropped shooting settings and the lens used.

- RF or EF lenses: With : **Movie cropping**] set to **[Disable]**

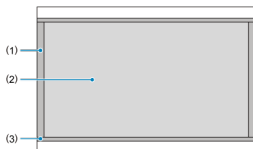

(1) **RAW** (6K RAW) (6000×3164) / **4K-D** (4096×2160)

(2) **4K-U** (3840×2160)

(3) **4K-U** (time-lapse) / **FHD** (1920×1080) / **FHD** (time-lapse)

- RF or EF lenses: With : **Movie cropping**] set to **[Enable]**
- RF-S or EF-S lens

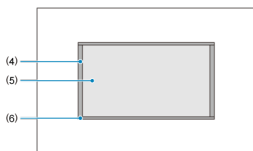

(4) **4K-D** (4096×2160)

(5) **4K-U** (3840×2160)

(6) **4K-U** (time-lapse) / **FHD** (1920×1080) / **FHD** (time-lapse)

Caution

- Recording with Movie digital IS  further crops the image around the center of the screen.

Frame rate (fps: frames per second)

- **[239.8P] 239.8fps/[119.9P] 119.9 fps/[59.94P] 59.94 fps/[29.97P] 29.97 fps**
For areas where the TV system is NTSC (North America, Japan, South Korea, Mexico, etc.). For [239.8P] or [119.9P], see [High Frame Rate](#).
- **[200.0P] 200.00fps/[100.0P] 100.00 fps/[50.00P] 50.00 fps/[25.00P] 25.00 fps**
For areas where the TV system is PAL (Europe, Russia, China, Australia, etc.). For [200.0P] or [100.0P], see [High Frame Rate](#).
- **[24.00P] 24.00 fps/[23.98P] 23.98 fps**
Mainly for cinematic purposes. **23.98P** (23.98 fps) is available when [: Video system] is set to [For NTSC].

Compression method

- **[ALL-I] ALL-I (For editing/I-only)**
Compresses each frame, one at a time, for recording. Although file sizes are larger than with IPB (Standard), movies are more suitable for editing.
- **[IPB] IPB (Standard)**
Compresses multiple frames at a time efficiently for recording. File sizes are smaller than with ALL-I (For editing), which enables movie recording over longer periods (with a card of the same capacity).
- **[IPB ] IPB (Light)**
Since the movie is recorded at a bit rate lower than with IPB (Standard), the file size will be smaller than with IPB (Standard) and the playback compatibility will be higher. This will make the available recording time longer than with IPB (Standard) (with a card of the same capacity).

Cards That Can Record Movies

For details on CFexpress cards that can record at each level of movie recording quality, check the Canon website (🔗).

See [Card performance requirements](#) for details on SD cards.

Test cards by recording a few movies to make sure they can record correctly at your specified size (🔗).

Caution

- Before recording 4K movies, format cards by selecting [**Low level format**] in [**Format card**] (🔗).
- If you use a slow-writing card when recording movies, the movie may not be recorded properly. Also, if you play back a movie on a card with a slow reading speed, the movie may not be played back properly.
- When recording movies, use high-performance cards with a writing speed sufficiently higher than the bit rate.
- When movies cannot be recorded properly, format the card and try again. If formatting the card does not resolve the problem, refer to the card manufacturer's website, etc.

Unsupported movie recording

- The following files cannot be recorded to SD cards. Pressing the movie shooting button will not start recording.
 - RAW movies (6K RAW)
 - 4K 119.9/100.0 fps (High Frame Rate movies)
 - 4K 59.94/50.00 fps ALL-I

Note

- To obtain better performance with the card, formatting the card with the camera before recording movies is recommended (🔗).
- To check the card's writing/reading speed, refer to the card manufacturer's website, etc.

Movie Files Exceeding 4 GB

- Individual movie files exceeding 4 GB cannot be recorded to SD cards.
- With SDHC cards, once the movie file size reaches 4 GB, a new movie file is created automatically. When you play back the movie, you will have to play back each movie file individually. Movie files cannot be played back automatically in consecutive order. After the movie playback ends, select the next movie and play it back.
- With CFexpress or SDXC cards, individual movies are recorded as a single file, even if they exceed 4 GB.

Caution

- When importing movie files exceeding 4 GB to a computer, use either EOS Utility or a card reader (🔗). It may not be possible to save movie files exceeding 4 GB if you attempt this using standard features of the computer's operating system.

Total Movie Recording Time and File Size Per Minute

For details, see [Movie recording](#).

High Frame Rate

You can record movies at high frame rates of 239.8/200.0 fps or 119.9/100.0 fps. This is ideal for recording movies that will be played back in slow motion. The maximum recording time per movie is 89 min. 29 sec.

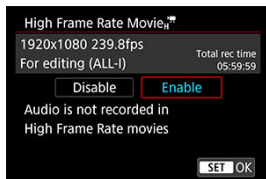

- **239.8P/200.0P** is available with the recording size set to **FHD**.
- The compression method is **ALL-I**.
- Sound is not recorded in High Frame Rate movies.
- Count-up of time code display during movie recording is based on 29.97/25.00 fps.
- Because High Frame Rate movies are recorded as 29.97/25.00 fps movie files, they are played back in slow motion.

Caution

Precautions when set to [High Frame Rate: Enable]

- 239.8/200.0 fps recording is not available with SD/SDHC cards.
- Time codes are not recorded when [Count up] is set to [Free run] in [Time code] (☑).
- Check the [Movie rec. size] setting if you return this setting to [Disable].
- The screen may flicker if you record High Frame Rate movies under fluorescent or LED lighting.
- For a moment when you start or stop recording High Frame Rate movies, the movie is not updated, and the frame stops momentarily. Be aware of this when recording movies to external devices via HDMI.
- Movie frame rates shown on the screen as you record High Frame Rate movies do not correspond to the frame rate of the movie recorded.
- Headphones cannot be used (no sound is audible).
- ISO speed can be set within ISO 100–25600. Note that ISO expansion is not available.
- The frame rate of HDMI video output is 59.94 fps or 50.00 fps.
- The camera's internal temperature may rise and less recording time may be available after extended movie playback or image display.
- With the camera set to 239.8/200.0 fps, Movie digital IS may not provide sufficient stabilization when a macro lens is used to shoot subjects near the closest focusing distance.

Movie Recording Format

You can specify the format of movie files recorded. For RAW+MP4 recording, select **[1]** **RAW**, **[2]** **MP4** in the **[Rec options]** setting of **[Record func+card/folder sel.]**.

1. Select **[: Movie rec. format]**.

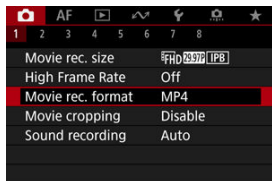

2. Select an option.

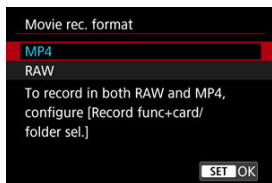

RAW movies

RAW (6K RAW) movies are raw, unprocessed data from the image sensor that are recorded to the card digitally.

Two format options are available for RAW movies, **RAW** (standard) and **RAW+L** (light), as selected in **[CAMERA] Movie rec. size** **[INFO]**. The light option produces RAW movies with smaller file sizes than the standard option.

You can use Digital Photo Professional (EOS software) to process RAW movies. You can make various adjustments to images depending upon how they will be used and can generate JPEG, HEIF, or other types of images reflecting the effects of those adjustments.

Caution

- RAW movies cannot be processed with **[PLAY] RAW image processing**.

Note

- To display RAW movies on a computer, using Digital Photo Professional (EOS software, hereafter DPP) is recommended.
- Older versions of DPP Ver. 4.x do not support display, processing, editing, or other operations with RAW movies recorded by this camera. If a previous version of DPP Ver. 4.x is installed on your computer, obtain and install the latest version of DPP from the Canon website to update it **[INFO]**, which will overwrite the previous version. Similarly, DPP Ver. 3.x or earlier does not support display, processing, editing, or other operations with RAW movies recorded by this camera.
- Commercially available software may not be able to display RAW movies recorded by this camera. For compatibility information, contact the software manufacturer.
- To prioritize gradation in highlights, set **[Canon Log]** in **[CAMERA] Canon Log settings** to **[On (C.LOG3)]**. This is recommended for Cinema EOS and RAW movies.

Movie Cropping

With RF or EF lenses, movies can be cropped around the center of the image, as if using a telephoto lens.

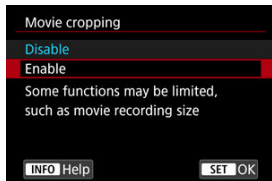

Recording movies with RF-S or EF-S lenses has the same effect as this movie cropping feature.

1. Select [: Movie cropping].



2. Select [Enable].

Caution

- The center of the screen is further cropped, reducing the recording area, when [ **Digital IS**] in [: **IS (Image Stabilizer) mode**] is set to [On] or [Enhanced].

Note

- The recording area available with movie cropping is the same as when recording movies with RF-S or EF-S lenses.
- For details on the recording area, see [Image Area](#).

Sound Recording

 [Sound Recording/Sound-Recording Level](#)

 [Wind Filter](#)

 [Attenuator](#)

You can record movies while recording sound with either the built-in microphone or an external one. You can also freely adjust the sound-recording level.

Use : **Sound recording** to set sound recording functions.

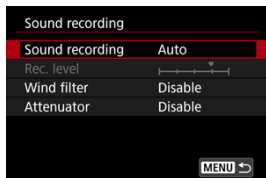

Caution

- Sounds from Wi-Fi operations may be captured with built-in or external microphones. During sound recording, using the wireless communication function is not recommended.
- Make sure any output plugs of external microphones or any headphone jacks are fully inserted in the camera.
- The camera's built-in microphone may also record mechanical sounds of the lens or sounds of camera/lens operations if AF operations are performed or the camera or lens is operated during movie recording. If so, it may help reduce these sounds if you use an external microphone equipped with an output plug and position it away from the camera and lens.
- Do not connect anything other than an external microphone to the camera's external microphone IN terminal.
- Noise reduction is not applied to the audio played through headphones. Thus, the audio recorded with the movie will be different.
- Do not change the : **Sound recording** settings when listening with headphones. This may cause sudden loud output that may hurt your ears.

 **Note**

- Audio is also output when the camera is connected to televisions via HDMI, except when **[Sound recording]** is set to **[Disable]**. In case of feedback from television audio output, move the camera away from the television or turn down the volume.
- The volume balance between L/R (left/right) cannot be adjusted.
- Sound is recorded at a 48 kHz/16-bit sampling rate.

Sound Recording/Sound-Recording Level

- **Auto**

The sound-recording level is adjusted automatically. Auto level control will take effect automatically in response to the sound level.

- **Manual**

You can adjust the sound-recording level as needed. Select **[Rec. level]** and turn the  dial while looking at the level meter to adjust the sound-recording level. Look at the peak hold indicator, and adjust so that the level meter sometimes lights up on the right of the "12" (-12 dB) mark for the loudest sounds. If it exceeds "0", the sound will be distorted.

- **Disable**

Sound will not be recorded.

Wind Filter

Set to **[Enable]** to reduce wind noise when there is wind outdoors. Only activated when the camera's built-in microphone is used. When the wind filter function takes effect, part of the low bass sounds will also be reduced.

Attenuator

Automatically suppresses sound distortion caused by loud noises. Even if **[Sound recording]** is set to **[Auto]** or **[Manual]** for recording, sound distortion may still result if there is a very loud sound. In this case, setting it to **[Enable]** is recommended.

● Microphone

Any connected external microphone is used instead of the built-in microphone. The following external microphones (sold separately) are recommended.

- **Multi-Function Shoe Directional Stereo Microphone DM-E1D**

Attaches to the camera's multi-function shoe (🔗).

- **Directional Stereo Microphone DM-E1 / Stereo Microphone DM-E100**

The external microphone's 3.5 mm mini-plug connects to the camera's external microphone IN terminal (🔗). The microphone itself attaches to the camera's multi-function shoe.

● Headphone

By connecting commercially available headphones with a 3.5 mm mini-plug to the headphone terminal (🔗), you can listen to the sound as movies are recorded and hear camera operating sounds. To adjust headphone volume, press the < [Q] > button, select [🔊], and adjust by turning the < 🔄 > or < 🔄 > dial or press < * > left or right (🔗). You can also use headphones during movie playback.

Note

- Headphone volume can also be adjusted in [🔊: Headphones].
- The volume of sounds for camera operations is adjusted in [🔊: Volume].

HDR Movie Recording

You can record high dynamic range movies that retain detail in highlights of high-contrast scenes.

Note

- Available when the recording size is set to **FHD 29.97P [IPB]** (NTSC) or **FHD 25.00P [IPB]** (PAL).

1. Select [HDR Movie Recording].

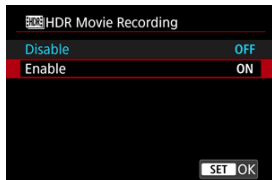
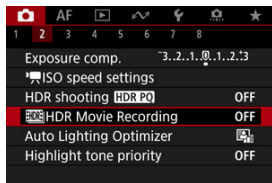







- Select [**Enable**].

2. Record an HDR movie.

- Record the movie in the same way as normal movie recording.
- For details on file sizes and the recording time available, see [Movie recording](#).

 **Caution**

- HDR movie recording is not available with [: **IS (Image Stabilizer) mode**] set to [ **Digital IS**], or when set to [: **Time-lapse movie**], [: **Highlight tone priority**], [: **Canon Log settings**], or [: **HDR shooting (HDR PQ)**].
- Since multiple frames are merged to create an HDR movie, certain parts of the movie may look distorted. This is more noticeable in handheld recording affected by camera shake, so consider using a tripod. Note that even if a tripod is used for recording, afterimages or noise may become more noticeable, compared to normal playback, when the HDR movie is played back frame-by-frame or in slow motion.
- Image color and brightness may change significantly for a moment if you change settings for HDR movie recording. Also, the movie will not be updated for a moment, and the frame stops momentarily. Be aware of this when recording movies to external devices via HDMI.

Canon Log Settings

 [Shooting Settings](#)

 [Canon Log Image Quality](#)

Canon Log gamma curve takes full advantage of image sensor characteristics to ensure wide dynamic range for movies that will be processed in postproduction. With minimal loss of detail in shadows and highlights, movies retain more visual information across the dynamic range.

To work with Canon Log movies in postproduction, you can apply look-up tables (LUTs). LUT data can be downloaded from the Canon website.

1. Select [📷: Canon Log settings].

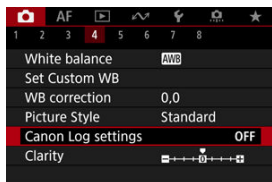

2. Select [Canon Log].

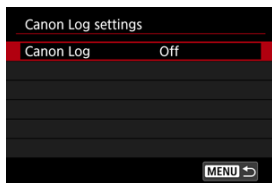

3. Select [On (C.LOG3)] (C).

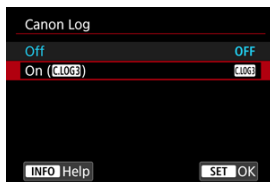

4. Set the options as desired.

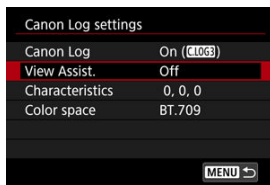

- Set [View Assist.](#), [Characteristics](#), and [Color space](#).

Canon Log

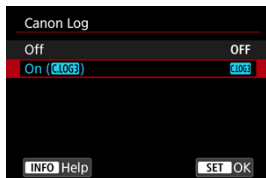

- **On**

Enables 10-bit recording of Canon Log movies to the card. Movies can also be recorded to an external device that supports 10-bit recording.

 **Note**

- YCbCr 4:2:2 (10-bit) color sampling and the BT.709/BT.2020/Cinema Gamut color space are used in Canon Log recording.

View Assist.

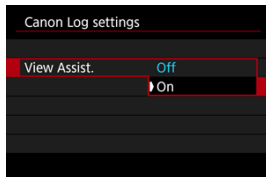

When played on the camera, these movies may look darker and have lower contrast than movies recorded with a Picture Style applied, due to Canon Log image characteristics, which are intended to ensure a wide dynamic range. For clearer display that makes it easier to check details, set **[View Assist.]** to **[On]**.

- Setting this feature to **[On]** does not affect movies recorded to the card, which are recorded using Canon Log characteristics. Similarly, HDMI video output has Canon Log characteristics, and View Assist is not used for it.

Note

- **[V.Assist]** is shown on the information display screen during movie recording with View Assist.
- When set to **[On]**, View Assist is also used with magnified display.

Characteristics

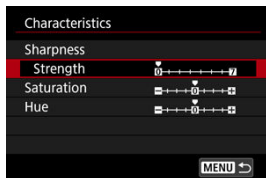

Adjust as needed. Select an option ([**Sharpness: Strength**], [**Saturation**], or [**Hue**]), adjust the effect level, then press < (SET) >.

Sharpness: Strength		0: Weak outline emphasis	7: Strong outline emphasis
Saturation		-4: Low	+4: High
Hue*	Reds	-4: Toward magenta	+4: Toward yellow
	Greens	-4: Toward yellow	+4: Toward cyan
	Blues	-4: Toward cyan	+4: Toward magenta

* Reds, greens, and blues cannot be adjusted separately.

Color space

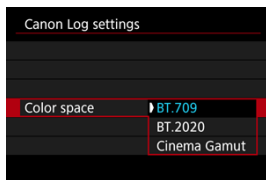

Choose [**BT.709**], [**BT.2020**], or [**Cinema Gamut**] as the color space for HDMI output or recording to cards.

Shooting Settings



- Manually setting the ISO speed to 100–640 will make the dynamic range narrower.
- Canon Log offers a dynamic range of approx. 1600% at ISO 800 or higher.
- The following are expanded ISO speeds: ISO 100, 125, 160, 200, 250, 320, 400, 500 and 640. [L] is displayed when an ISO speed is set.

Canon Log Image Quality

- With Canon Log, movies may be affected by horizontal banding, depending on the subject or shooting conditions. Record a few test movies and check the results in advance. In particular, noise may become more noticeable if you enhance the contrast when color-grading your movies.
- With Canon Log, skies, white walls, and similar subjects may be affected by noise or uneven gradation, exposure, or colors.
- Horizontal banding is more likely to occur when recording somewhat dark, flat subjects. This image noise may even occur at relatively low ISO speeds around ISO 800.
- If noise is noticeable, try recording under brighter conditions and adjusting brightness in color grading. Although dynamic range is narrower at ISO speeds lower than ISO 800, noise can also be reduced by recording this way.

Caution

General Canon Log shooting precautions

- Canon Log and Canon Log 2 are not supported.
- With Canon Log, autofocusing may be more difficult for subjects under low light, or for low-contrast subjects. Difficulty in autofocusing can be reduced by shooting near maximum aperture or using a bright lens.
- Noise may appear at image edges if **[Peripheral illum corr]** in : **Lens aberration correction** is set to **[Enable]** when Canon Log is set.
- Histograms with **[Canon Log]** in : **Canon Log settings** set to **[On (C.LOG3)]** are not based on conversion for View Assist display. Image areas shown in gray in the histogram roughly indicate signal values that are not used.

Note

Playing back movies recorded with Canon Log



- View Assist is not used during movie playback.

Time-Lapse Movies

[Approx. Time Available for Recording Time-Lapse Movies](#)

Still photos shot at a set interval can be stitched together automatically to create a 4K or Full HD time-lapse movie. A time-lapse movie shows how a subject changes in a much shorter period of time than the actual time it took. It is effective for a fixed-point observation of changing scenery, growing plants, celestial motion, etc.

Time-lapse movies are recorded in MP4 format at the following quality: $\text{4K-U29.97P [ALL-I]}$ (NTSC)/ $\text{4K-U25.00P [ALL-I]}$ (PAL) in 4K recording, and FHD29.97P [ALL-I] (NTSC)/ FHD25.00P [ALL-I] (PAL) in Full HD recording.

Note that the frame rate is updated automatically to match the [: Video system] setting ().

1. Select [: Time-lapse movie].

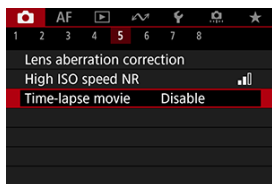

2. Select [Time-lapse].

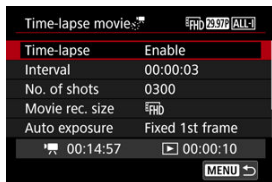

- Select [Enable].

3. Set [Interval].

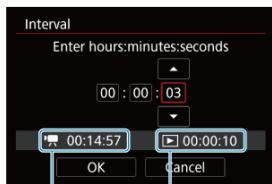









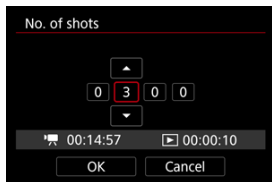

(1)

(2)

- Select [Interval].
- As you set the number, refer to the [🔊] time required (1) and [▶] playback time (2).
- Select an option (hours : minutes : seconds).
- Press <Ⓢⓔᐓ> to display [⏏].
- Set the desired number, then press <Ⓢⓔᐓ>. (Returns to [□].)
- Can be set in a range of [00:00:02]–[99:59:59]. (An interval of once per second is not available.)
- Select [OK] to register the setting.

4. Set [No. of shots].



- Select **[No. of shots]**.
- As you set the number, refer to the time required ([) and playback time ([)].
- Select the digit.
- Press <  > to display [].
- Set the desired number, then press <  >. (Returns to [].)
- Can be set in a range of **[0002]–[3600]**.
- Make sure the playback time ([) is not displayed in red.
- Select **[OK]** to register the setting.
- The playback time ([) is displayed in red if the card does not have enough free space to record the specified number of shots. Although the camera can continue recording, the recording will stop when the card becomes full.
- Playback time ([) is displayed in red if the **[No. of shots]** setting results in a file size exceeding 4 GB for a card not formatted in exFAT (). If you keep recording in this condition and the movie file size reaches 4 GB, the time-lapse movie recording will stop.



Note

- For details on cards that can record time-lapse movies (card performance requirements), see [Card performance requirements](#).
- If the number of shots is set to 3600, the time-lapse movie will be approx. 2 min. in NTSC and approx. 2 min. 24 sec. in PAL.

5. Select [Movie rec. size].

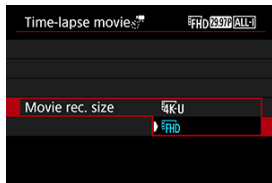

- **4K-U (3840×2160)**

The movie is recorded in 4K quality. The aspect ratio is 16:9. Additionally, the frame rate is 29.97 fps (**29.97P**) for NTSC and 25.00 fps (**25.00P**) for PAL, and movies are recorded in MP4 (**MP4**) format with ALL-I (**ALL-I**) compression.

- **FHD (1920×1080)**

The movie will be recorded in Full High-Definition (Full HD) quality. The aspect ratio is 16:9. Additionally, the frame rate is 29.97 fps (**29.97P**) for NTSC and 25.00 fps (**25.00P**) for PAL, and movies are recorded in MP4 (**MP4**) format with ALL-I (**ALL-I**) compression.

6. Set [Auto exposure].



- **Fixed 1st frame**

When taking the first shot, metering is performed to set the exposure automatically to match the brightness. The exposure setting for the first shot will be applied to subsequent shots. Other shooting-related settings for the first shot will also be applied for subsequent shots.

- **Each frame**

Metering is also performed for each subsequent shot to set the exposure automatically to match the brightness. Note that any functions such as Picture Style and white balance that are set to **[Auto]** will be set automatically for each subsequent shot.

! **Caution**

- Significant changes in brightness between shots may prevent the camera from shooting at the specified interval when **[Interval]** is set to less than 3 sec. and **[Auto exposure]** is set to **[Each frame]**.

7. Set [Screen auto off].

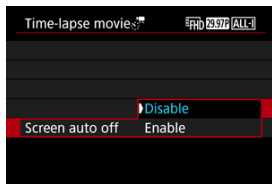

- **Disable**

Even during time-lapse movie recording, the image will be displayed. (The screen turns off only at the time of shooting.) Note that the screen will turn off when approx. 30 min. elapse after the shooting started.

- **Enable**

Note that the screen will turn off when approx. 10 sec. elapse after the shooting started.

Caution

- Even if [**Screen auto off**] is set to [**Disable**], the screen turns off during exposure. Also note that images may not be displayed if the interval between shots is too brief.

Note

- During time-lapse movie recording, you can press the < **INFO** > button to turn on/off the screen.

8. Set [Beep as img taken].

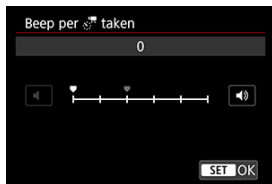

- Set to [0] to prevent the camera from beeping for each shot.

9. Check the settings.



(1)

(2)

- **Time required (1)**

Indicates the time required to shoot the set number of shots with the set interval. If it exceeds 24 hours, "**** days" will be displayed.

- **Playback time (2)**

Indicates the movie recording time (equivalent to the time required for playback) once the movie is created from still photos taken at regular intervals.

10. Close the menu.

- Press the < MENU > button to turn off the menu screen.

11. Read the message.

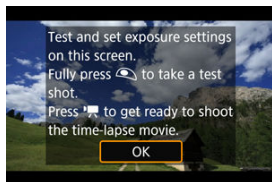

- Read the message and select [OK].

12. Take a test shot.

- As in still photo shooting, set the exposure and shooting functions, then press the shutter button halfway to focus.
- Press the shutter button completely to take a test shot, which is recorded to the card as a still photo.
- If there are no problems with the test shot, go to the next step.
- To take more test shots, repeat this step.

Note

- Test shots are captured in JPEG quality.
- In [TV] or [M] mode, you can set the shutter speed in a range of 1/4000 to 30 sec.
- You can set the maximum limit for Auto ISO in [P], [TV], and [Av] mode or in [M] mode with ISO Auto, in the [Max for Auto] option of [ISO speed settings] .
- If you have set [Half-press] in [Shutter btn function for movies] to [Meter.+ Servo AF], it is automatically changed to [Meter.+One-Shot AF] when you set up time-lapse movie recording.

13. Press the movie shooting button.

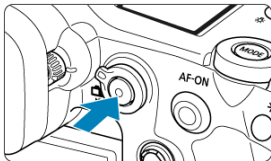

- The camera is now ready to start recording a time-lapse movie.
- To return to step 12, press the movie shooting button again.

14. Record the time-lapse movie.



- Press the **< INFO >** button and double-check the Time required (1) and Interval (2) shown on the screen.

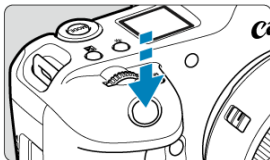

- **Press the shutter button completely to start recording the time-lapse movie.**
- AF will not work during time-lapse movie recording.
- A recording icon “●” is displayed on the screen as the time-lapse movie is recorded.
- When the set number of shots are taken, the time-lapse movie recording ends.
- **To cancel recording time-lapse movies, set [Time-lapse] to [Disable].**

 **Note**

- Using a tripod is recommended.
- Taking test shots as in step 12 or even recording test time-lapse movies beforehand is recommended.
- The movie's field of view coverage for both the 4K and Full HD time-lapse movie recording is approx. 100%.
- To cancel time-lapse movie recording in progress, either press the shutter button completely or press the movie shooting button. The time-lapse movie shot so far will be recorded on the card.
- If the time required for recording is more than 24 hours but not more than 48 hours, "2 days" will be indicated. If three or more days are required, the number of days will be indicated in 24-hour increments.
- Even if the time-lapse movie's playback time is less than 1 sec., a movie file will still be created. In this case, "00'00" is indicated in **[Playback time]**.
- If the shooting time is long, using the household power outlet accessories (sold separately) is recommended.
- YCbCr 4:2:0 (8-bit) color sampling and the BT.709/BT.2020 color space are used.

Caution

- Do not point the camera toward an intense light source, such as the sun or an intense artificial light source. Doing so may damage the image sensor or the camera's internal components.
- Time-lapse movies cannot be recorded when the camera is connected to a computer with the interface cable, or when an HDMI cable is connected.
- Movie Servo AF will not function.
- For time-lapse movies in [M] mode, aperture is fixed and exposure is controlled using ISO speed.
- If the shutter speed is 1/30 sec. or slower, the exposure of the movie may not be displayed properly (may differ from that of the resulting movie).
- Do not zoom the lens during time-lapse movie recording. Zooming the lens may cause the image to be out of focus, the exposure to change, or the lens aberration correction not to function properly.
- Recording time-lapse movies under flickering light may cause noticeable screen flickering, and images may be captured with horizontal stripes (noise) or irregular exposure.
- Images displayed as time-lapse movies are recorded may look different from the resulting movie (in details such as inconsistent brightness from flickering light sources, or noise from a high ISO speed).
- When recording a time-lapse movie under low light, the image displayed during shooting may look different from what is actually recorded in the movie. In such cases, the [Exp.SIM] icon will blink.
- If you move the camera from left to right (panning) or shoot a moving subject during time-lapse movie recording, the image may look extremely distorted.
- During time-lapse movie recording, auto power off will not take effect. Also, you cannot adjust the shooting function and menu function settings, play back images, etc.
- No sound or time codes are recorded for time-lapse movies.
- To start or stop time-lapse movie recording, you can press the shutter button completely, regardless of the [Shutter btn function for movies] setting.
- Significant changes in brightness between shots may prevent the camera from shooting at the specified interval when [Interval] is set to less than 3 sec. and [Auto exposure] is set to [Each frame].
- If the shutter speed exceeds the shooting interval (such as for long exposures), or if a slow shutter speed is set automatically, the camera may not be able to shoot at the set interval. Shooting may also be prevented by shooting intervals nearly the same as the shutter speed.
- If the next scheduled shot is not possible, it will be skipped. This may shorten the recording time of the created time-lapse movie.
- If the time it takes to record to the card exceeds the shooting interval due to the shooting functions set or card performance, some of the shots may not be taken with the set intervals.
- The captured images are not recorded as still photos. Even if you cancel the time-lapse movie recording after only one shot is taken, it will be recorded as a movie file.

- Set [: **Time-lapse movie**] to [**Disable**] if you will connect the camera to a computer with the interface cable and use EOS Utility (EOS software). Options other than [**Disable**] will prevent the camera from communicating with the computer.
- Image stabilization is not applied in time-lapse movie recording.
- Time-lapse movie shooting ends if the power switch is set to <OFF>, for example, and the setting is changed to [**Disable**].
- Even if a flash is used, it will not fire.
- The following operations cancel standby for time-lapse movie recording and switch the setting to [**Disable**].
 - Selecting either [**Clean now**] in [: **Sensor cleaning**] or [**Basic settings**] in [**Reset camera**]
- Image quality may be lower if you start time-lapse movie recording while the white [] temperature warning icon () is displayed. It is recommended that you start time-lapse movie recording after the white [] icon disappears (camera's internal temperature decreases).
- With [**Auto exposure**] set to [**Each frame**], the ISO speed, shutter speed, and aperture value may not be recorded in the time-lapse movie Exif information in some shooting modes.

Note

- You can use Wireless Remote Control BR-E1 (sold separately) to start and stop time-lapse movie recording.

With Wireless Remote Control BR-E1

- First, pair Wireless Remote Control BR-E1 with the camera ()
- Set [: **Remote control**] to [**Enable**].
- After you take some test shots and the camera is ready to shoot (as in step 13,) , set the release timing/movie shooting switch on the BR-E1 to <●> (immediate release) or <2> (2-sec. delay).
- If the remote control's switch has been set to < >, the time-lapse movie recording cannot start.

Camera Status/Remote Control Setting	<●> Immediate Release <2> 2-sec. Delay	< > Movie Recording
Test-recording screen	Test recording	To recording standby
Recording standby	Starts recording	To test-recording screen
During time-lapse movie recording	Ends recording	Ends recording

Approx. Time Available for Recording Time-Lapse Movies

For guidelines on how long you can record time-lapse movies (until the battery runs out), see [Movie recording](#).

Movie Self-Timer

Movie recording can be started by the self-timer.

1. Select [📷: Movie self-timer].

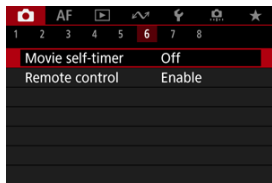

2. Select an option.

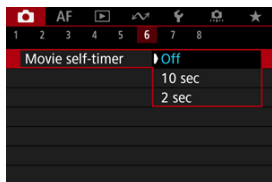

3. Record the movie.

- After you press the movie shooting button or tap [●], the camera beeps and displays the number of seconds left before recording.

Note

- To cancel the self-timer, either tap the screen or press < (SET) >.

Image Stabilizer (IS Mode)

[Movie Digital IS](#)

The camera's IS mode and movie digital IS features reduce camera shake as movies are recorded.

They can provide effective stabilization even when non-IS lenses are used.

The **[IS mode]** menu item is not shown when IS-equipped lenses are used. In that case, setting the lens Image Stabilizer switch to **< ON >** combines stabilization by the lens and camera.

1. Select [: IS (Image Stabilizer) mode].

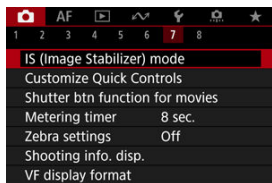

2. Select **[IS mode]**.

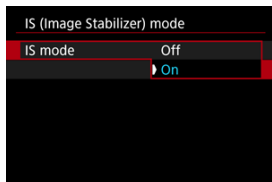

- Select **[On]** to use IS mode on the camera.

Caution

- **[IS mode]** is not displayed when an IS-equipped lens is attached.

1. Select [📷: IS (Image Stabilizer) mode].

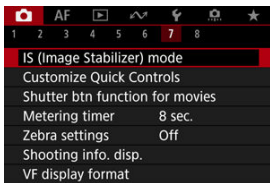

2. Select a [📷 Digital IS] option.

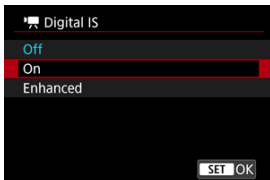

- **Off** (📷 OFF)
Image stabilization with Movie digital IS is disabled.
- **On** (📷 ON)
Camera shake will be corrected. The image will be slightly magnified.
- **Enhanced** (📷 ENH)
Compared to when [On] is set, stronger camera shake can be corrected. The image will be more magnified.

Caution

- Movie digital IS will not function when the lens's optical Image Stabilizer switch is set to < OFF >.
- With non-IS lenses, setting [ Digital IS] to [On] or [Enhanced] also sets [IS mode] to [On].
- Although movies can also be recorded with Movie digital IS when using RF-S or EF-S lenses or movie cropping, the image area is further reduced.
- Stabilization by Movie digital IS may be less effective at some movie recording sizes.
- The wider the angle of view (wide angle), the more effective the image stabilization will be. The narrower the angle of view (telephoto), the less effective the image stabilization will be.
- When using a tripod, setting Movie digital IS to [Off] is recommended.
- Depending on the subject and shooting conditions, the subject may blur noticeably (the subject momentarily looks out of focus) due to the effects of the Movie digital IS.
- Consider setting to [Off] when using a TS-E lens or fish-eye lens.
- Since Movie digital IS magnifies the image, the image looks more grainy. Noise, dots of light, etc. may also become noticeable.

Note

- For details on configuring image stabilization for still photo shooting, see [Image Stabilizer \(IS Mode\)](#).
- With some lenses, even more effective stabilization (indicated by "+" next to the IS icon) is possible when the lens's IS is used in conjunction with [IS mode] and [Movie digital IS] on the camera. For details on lenses compatible with this feature, visit the Canon website ([🌐](#)).

Shutter Button Function for Movies

You can set the functions performed by pressing the shutter button halfway or completely during movie recording.

Caution

- In movie recording, the **[Shutter btn function for movies]** setting overrides any function assigned to the shutter button in **[Customize buttons]**.

1. Select **[Shutter btn function for movies]**.

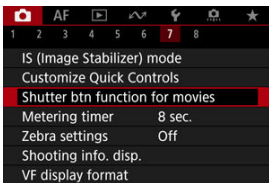

2. Select an option.

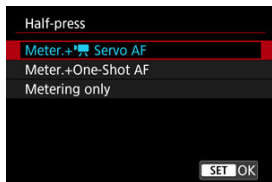

- **Half-press**
Specify the function performed by pressing the shutter button halfway.
- **Fully-press**
Specify the function performed by pressing the shutter button completely.

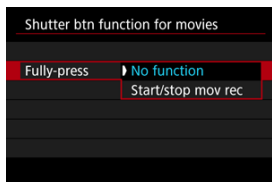

With **[Fully-press]** set to **[Start/stop mov rec]**, you can start/stop movie recording not only with the movie shooting button but also by pressing the shutter button completely, or by using Remote Switch RS-80N3 (sold separately).

Zebra Settings

To help you adjust exposure before or during movie recording, you can display a striped pattern over or around image areas of a specified brightness.

1. Select [: Zebra settings].

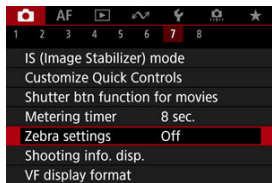

2. Select [Zebra].

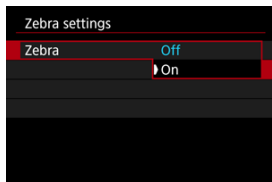

- Select [On].

3. Select [Zebra pattern].

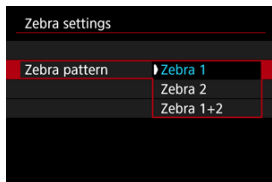

- [Zebra 1]: Displays left-slanting stripes around areas of the specified brightness.
- [Zebra 2]: Displays right-slanting stripes over areas that exceed the specified brightness.
- [Zebra 1+2]: Displays both [Zebra 1] and [Zebra 2]. [Zebra 1] display takes precedence where [Zebra 1] and [Zebra 2] display areas overlap.

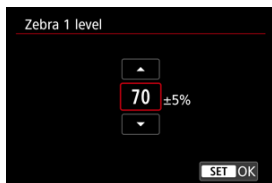

4. Set the level.

Zebra 1 level



Zebra 2 level



- Set by turning the  > or <  > dial or pressing <  > up or down.



Note

- The maximum brightness value does not reach 100% when HDR-PQ is set. Note that the maximum brightness value varies depending on [📷: **Highlight tone priority**] and [📷: **Picture Style**] settings.
- The maximum brightness value does not reach 100% when Canon Log or an expanded ISO speed is set.
- Checking the zebra display level in advance is recommended when you will set [**Zebra pattern**].

Time Code

- [Count Up](#)
- [Start Time Setting](#)
- [Movie Recording Count](#)
- [Movie Play Count](#)
- [HDMI](#)
- [Drop Frame](#)

Time codes record the time automatically as movies are recorded. Time codes always record elapsed hours, minutes, seconds, and frames. They are mainly used when movies are edited.

To set up the time code, use [: **Time code**].

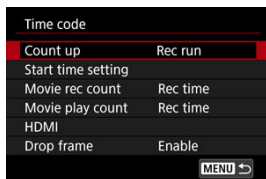

Caution

- Time codes may not be displayed correctly if your movies are played back on devices other than the camera.

Count Up

- **Rec run**
The time code advances only during movie recording. Time codes in each movie file recorded continue from the last time code in the previous file.
- **Free run**
The time code keeps advancing, even when you are not recording.

Caution

- When set to **[Free run]**, time codes are not added to High Frame Rate movies that you record.
- When set to **[Free run]**, time codes will be affected by any changes to settings for time, zone, or daylight saving time ().

Start Time Setting

You can set the initial time of the time code.

- **Manual input setting**
Enables you to set any starting hour, minute, second, and frame.
- **Reset**
Resets the time set with **[Manual input setting]** or **[Set to camera time]** to "00:00:00."
or "00:00:00:" (Ⓢ).
- **Set to camera time**
Matches the hour, minute, and second set as the time on the camera. Sets the frame value to "00."

Movie Recording Count

You can select how time is displayed on the movie recording screen.

- **Rec time**

During recording standby, displays the available recording time. During recording, displays the time that has elapsed since movie recording began (1).

- **Time code**

Displays the time code during movie recording (2).



Movie Play Count

You can select how time is displayed on the movie playback screen.

- **Rec time**
Displays the recording or playback time during movie playback.
- **Time code**
Displays the time code during movie playback.



Note

- Time codes are always recorded to movie files (except when High Frame Rate movies are set to **[Free run]**), regardless of the **[Movie rec count]** setting.
- The **[Movie play count]** setting in **[📷: Time code]** is linked to the **[▶]: Movie play count]**, so that these settings always match.
- The “frame” count is not displayed during movie recording or playback.

● Time code

Time codes can be added to movies as you record them to an external device via HDMI.

• Off

No time code is added to HDMI video output.

• On

Time codes are added to HDMI video output. When **[On]** is set, **[Rec Command]** is displayed.

● Rec Command

For HDMI video output recorded by an external device, you can synchronize recording to when you start and stop recording movies on the camera.

• Off

Recording is started and stopped by the external device.

• On

Recording by an external device is synchronized to starting/stopping recording on the camera.



Caution

- Time codes are not added to HDMI video output when you record High Frame Rate movies with **[Count up]** in **[Time code]** set to **[Free run]**.
- To determine compatibility of external recording devices with **[Time code]** and **[Rec Command]** functions, check with the device manufacturer.
- Even with **[Time code]** set to **[Off]**, external recording devices may add time codes to movies, depending on their specifications. For details on device specifications relevant to adding time code to HDMI input, check with the device manufacturer.

Drop Frame

The time code's frame count will cause a discrepancy between the actual time and the time code if the frame rate is set to **119.9P** (119.9 fps), **59.94P** (59.94 fps), or **29.97P** (29.97 fps). The discrepancy is corrected automatically when **[Enable]** is set.

- **Enable**

Corrects the discrepancy automatically by skipping time code numbers (DF: drop frame).

- **Disable**

The discrepancy is not corrected (NDF: non-drop frame).
Time codes are displayed as follows.

- **Enable (DF)**

00:00:00. (Playback: 00:00:00.00)

- **Disable (NDF)**

00:00:00. (Playback: 00:00:00.00)



Note

- The **[Drop frame]** setting item is not displayed when the frame rate is set to **24.00P** (24.00 fps), **23.98P** (23.98 fps), or when **[Video system]** is set to **[For PAL]**.

Other Menu Functions



[CAMERA] [CAMERA]

- **Exposure comp.**

Exposure compensation can be adjusted in a range of ± 3 stops, in 1/3-stop increments. For details on exposure compensation, see [Manual Exposure Compensation](#).

- **ISO speed settings**

- **ISO speed**

In [M] mode, you can set the ISO speed manually. You can also select ISO Auto.

- **ISO speed range**

You can set the manual ISO speed setting range (minimum and maximum). ISO expansion can also be configured.

- **Max for Auto**

You can set the maximum limit for ISO Auto in movie recording in [P], [TV], or [AV] mode or in [M] mode with ISO Auto.

- **Max for Auto**

You can set the maximum limit for ISO Auto in 4K time-lapse/Full HD time-lapse movie recording in [P], [TV], or [AV] mode or in [M] mode with ISO Auto.

- **HDR shooting [HDR PQ](#)**

For details on HDR shooting [HDR PQ](#), see [HDR PQ Settings](#).

- **Auto Lighting Optimizer**

Brightness and contrast can be corrected automatically. For details on Auto Lighting Optimizer, see [Auto Lighting Optimizer](#).

- **Highlight tone priority**

You can reduce overexposed, clipped highlights as you record movies. For details on Highlight tone priority, see [Highlight Tone Priority](#).

- **HF anti-flicker shooting**

For details on HF anti-flicker shooting, see [High-Frequency Anti-Flicker Shooting](#).

- **📷Av 1/8-stop incr.**

You can set aperture values on a finer scale when recording movies with an RF lens. Select **[Enable]** to change the aperture increment in [📷Av] or [📷M] mode from 1/3 stop (or 1/2 stop) to 1/8 stop.

! **Caution**

- [📷Av 1/8-stop incr.] is not available (not displayed) when EF or EF-S lenses are used.
- When set to **[Enable]**, setting options in [📷:: Exposure level increments] are disabled and have no effect.

- **📷 Auto slow shutter**

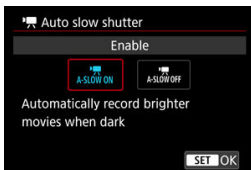

You can choose whether to record movies that are brighter and less affected by image noise than when set to **[Disable]** by automatically slowing the shutter speed under low light.

Available in [📷] or [📷Av] recording mode. Applies when the frame rate of the movie recording size is 59.94P or 50.00P.

- **Disable**

Enables you to record movies with smoother, more natural movement, less affected by subject shake than when set to **[Enable]**. Note that under low light, movies may be darker than when set to **[Enable]**.

- **Enable**

Enables you to record brighter movies than when set to **[Disable]** by automatically reducing the shutter speed to 1/30 sec. (NTSC) or 1/25 sec. (PAL) under low light.



Note

- Setting to **[Disable]** is recommended when recording moving subjects under low light, or when afterimages such as trails may occur.

- **White balance**

For details on white balance, see [White Balance](#).

- **Set Custom WB**

For details on registering custom white balances, see [Custom White Balance](#).

- **WB correction**

For details on white balance correction, see [White Balance Correction](#).

- **Picture Style**

For details on Picture Styles, see [Picture Style Selection](#).

- **Clarity**

For details on clarity, see [Clarity](#).

- **Lens aberration correction**

Peripheral illumination, distortion, chromatic aberration, and diffraction can be corrected as you record movies. For details on lens aberration correction, see [Lens Aberration Correction](#).

- **High ISO speed NR**

For details on High ISO speed noise reduction, see [High ISO Speed Noise Reduction](#).

- **Remote control**

By setting to **[Enable]**, you can start or stop movie recording using Wireless Remote Control BR-E1 (sold separately).

- **Customize Quick Controls**

For details on customizing Quick Controls, see [Customizing Quick Controls](#).

- **Metering timer**

For details on the metering timer, see [Metering Timer](#).

- **Shooting info. disp.**

For details on configuring shooting information display, see [Shooting Information Display](#).

- **VF display format**

For details on the viewfinder display format, see [Viewfinder Display Format](#).

- **Standby: Low res.**



Set to **[On]** to conserve battery power and control the rise of camera temperature during standby.

As a result, it may enable you to record movies over a longer period.

⚠ Caution

- Image quality on the standby screen may differ from image quality on the screen during movie recording, but this setting does not affect recording quality.
- Briefly when you start or stop recording movies, image display may remain on the current frame instead of being updated.

● HDMI display

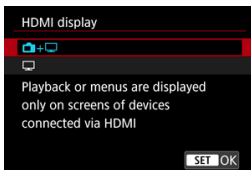

You can specify how movies are displayed as they are recorded via HDMI to an external device. Movie output itself corresponds to the **[Movie rec. size]** setting.

The default setting is **[Camera + Monitor]**.

- **[Camera + Monitor]**
Enables movie display both on the camera screen and on the other device, via HDMI output.
Camera operations such as image playback or menu display are shown on the other device via HDMI, not on the camera screen.
- **[Monitor]**
Deactivates the camera screen during output via HDMI, so that the screen is blank. Shooting information, AF points, and other information is shown on the external device via HDMI, but you can stop output of this information by pressing the **<INFO>** button.
Before recording movies externally, confirm that no information is being sent by the camera by making sure no shooting information, AF points, and so on is displayed on external monitors or other devices.
Settings such as time codes may not be recorded correctly in external movie recording with **[Camera Standby: Low res.]** set to **[On]**.

? For longer HDMI output

To continue HDMI output for longer than 30 min., select **[Camera + Monitor]**, then set **[Auto power off]** in **[Power saving]** to **[Disable]** (🚫). HDMI output will continue after the camera screen turns off when the time set in **[Screen off]** elapses.

 **Caution**

- HDMI output without information prevents display of warnings about the card space, battery level, or high internal temperature (🔒) via HDMI.
- During HDMI output, display of the next image may take some time if you switch between movies of different recording qualities or frame rates.
- Avoid operating the camera when recording movies to external devices, which may cause information to be displayed in the HDMI video output.
- Brightness and color of movies recorded with the camera may look different from that of HDMI video output recorded by external devices, depending on the viewing environment.

 **Note**

- By pressing the <INFO> button, you can change the information displayed.
- Time codes can be added to HDMI video output (🔒).
- Audio is also output via HDMI, except when **[Sound recording]** is set to **[Disable]**.







General Movie Recording Precautions

Caution

Precautions for movie recording

- Do not point the camera toward an intense light source, such as the sun or an intense artificial light source. Doing so may damage the image sensor or the camera's internal components.
- If you record something that has fine detail, moire or false colors may result.
- If [AWB] or [AWBW] is set and the ISO speed or aperture value changes during movie recording, the white balance may also change.
- If you record a movie under fluorescent or LED lighting, the movie image may flicker.
- If you perform AF with a USM lens during movie recording in low light, horizontal banding noise may be recorded in the movie. The same type of noise may occur if you focus manually with certain lenses equipped with an electronic focusing ring.
- Recording a few test movies is recommended if you intend to perform zooming during movie recording. Zooming as you record movies may cause exposure changes or lens sounds to be recorded, an uneven audio level, inaccurate lens aberration correction, or loss of focus.
- Large aperture values may delay or prevent accurate focusing.
- Performing AF during movie recording may cause the following kinds of issues: significant temporary loss of focus, recording of changes in movie brightness, temporary stopping of movie recording, or recording of mechanical lens sounds.
- Avoid covering the built-in microphones with your fingers or other objects.
- Connecting or disconnecting an HDMI cable during movie recording will end recording.
- If necessary, also see [General Still Photo Shooting Precautions](#).
- The camera may become hot in movie recording while connected via Wi-Fi. Use a tripod or take other measures to avoid handheld recording.
- Image quality may be lower when recording movies under a combination of conditions such as high ISO speeds, high temperatures, low shutter speeds, and low light.
- Recording movies over an extended period may cause the camera's internal temperature to rise and affect image quality. Turn off the camera when possible if you are not recording movies.

and display

-  may be displayed in hot environments or when factors such as recording movies or displaying images on the screen over extended periods increase the camera's internal temperature. If this condition continues, a red  icon will be displayed. Note that the time until a red  appears after the  icon varies depending on shooting conditions.
- The red  icon indicates that movie recording will soon be terminated automatically. Note that the time until movie recording stops automatically when the red  icon is displayed varies depending on shooting conditions.
- Red  icon display indicates that movie recording will soon stop automatically, so turn the camera off or take other measures, and wait until it cools down. Moreover, when you are not shooting or recording, always turn off the camera.
- After movie recording automatically stops, you will be unable to record movies or shoot still photos until the camera has cooled down.

Recording and image quality

- If the attached lens has an Image Stabilizer and you set the Image Stabilizer switch to **< ON >**, the Image Stabilizer will operate at all times even if you do not press the shutter button halfway. This will consume battery power, and it may reduce the total movie recording time. When the Image Stabilizer is not necessary, such as when using a tripod, it is recommended that you set the Image Stabilizer switch to **< OFF >**.
- If the brightness changes as you record a movie with auto exposure, the movie may appear to stop momentarily. In this case, record movies with manual exposure.
- If there is a very bright light source in the image, the bright area may appear black on the screen. Movies are recorded almost exactly as they appear on the screen.
- Image noise or irregular colors may occur when shooting at high ISO speeds, high temperatures, slow shutter speeds, or under low light. Movies are recorded almost exactly as they appear on the screen (except in time-lapse movie recording, or with : **Canon Log settings**] set to **[View Assist.]**).
- Video and audio quality of recorded movies may be worse on other devices, and playback may not be possible, even if the devices support MP4 formats.





- If you use a card with a slow writing speed, an indicator may appear on the right of the screen during movie recording. The indicator shows how much data has not yet been written to the card (remaining capacity of the internal buffer memory), and it increases more quickly the slower the card is. If the indicator (1) becomes full, movie recording will stop automatically.



- If the card has a fast writing speed, the indicator will not appear or the level (if displayed) will not increase much. First, record a few test movies to see if the card can write fast enough.
- If the indicator shows that the card is full, and movie recording stops automatically, the sound near the end of the movie may not be recorded properly.
- If the card's writing speed is slow (due to fragmentation) and the indicator appears, formatting the card may make the writing speed faster.

Note

Notes for movie recording

- Each time you record a movie, a new movie file is created on the card.
- Field of view (coverage) is approx. 100%.
- Focusing is also possible by pressing the < AF-ON > button.
- To enable starting/stopping movie recording by pressing the shutter button completely, set [Fully-press] for [ Shutter btn function for movies] to [Start/stop mov rec] ().
- The built-in microphone () records in mono.
- Any external microphones such as Directional Stereo Microphone DM-E1 (sold separately) connected to the camera's external microphone IN terminal are used instead of the build-in microphones ().
- Most external microphones equipped with a 3.5 mm mini-plug can be used.
- Focus preset during movie recording is available when using (super) telephoto lenses equipped with this function released in and after the second half of 2011.
- YCbCr 4:2:0 (8-bit) color sampling and the BT.709 color space are used for 4K and Full HD movies.

AF/Drive

This chapter describes autofocus operation and drive modes and introduces menu settings on the AF [**AF**] tab.

Note

- < **AF** > stands for autofocus. < **MF** > stands for manual focus.

- [Tab Menus: AF \(Still Photos\)](#)
- [Tab Menus: AF \(Movie Recording\)](#)
- [AF Operation](#)
- [Movie Servo AF](#)
- [Selecting the AF Area](#)
- [Manual Focus](#)
- [Registering People to Prioritize](#)
- [Servo AF Characteristics](#)
- [Customizing AF Functions](#)
- [Selecting the Drive Mode](#)
- [Using the Self-Timer](#)
- [Remote Control Shooting](#)

Tab Menus: AF (Still Photos)

- AF1

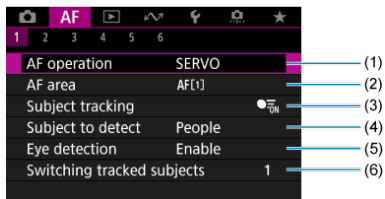

- (1) [AF operation](#)
- (2) [AF area](#)
- (3) [Subject tracking](#)
- (4) [Subject to detect](#)
- (5) [Eye detection](#)
- (6) [Switching tracked subjects](#)

Note

- When lenses without a focus mode switch are used, **[Focus mode]** is displayed on the **[AF1]** tab.

● AF2

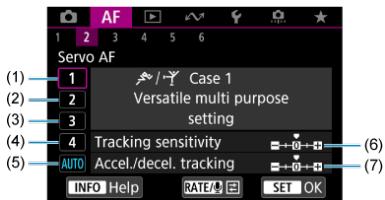

- (1) [Case 1](#)
- (2) [Case 2](#)
- (3) [Case 3](#)
- (4) [Case 4](#)
- (5) [Case A](#)
- (6) [Tracking sensitivity](#)
- (7) [Accel./decel. tracking](#)

● AF3

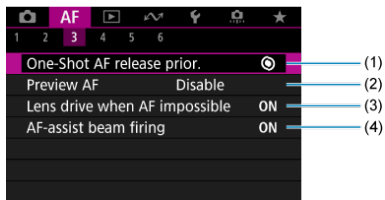

- (1) [One-Shot AF release prior.](#)
- (2) [Preview AF](#)
- (3) [Lens drive when AF impossible](#)
- (4) [AF-assist beam firing](#)

● AF4

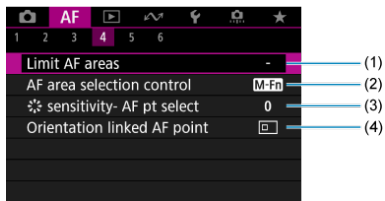

- (1) [Limit AF areas](#)
- (2) [AF area selection control](#)
- (3) [sensitivity- AF pt select](#)
- (4) [Orientation linked AF point](#)

● AF5

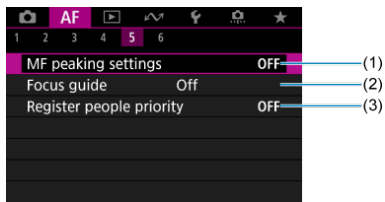

- (1) [MF peaking settings](#)
- (2) [Focus guide](#)
- (3) [Register people priority](#)

● AF6

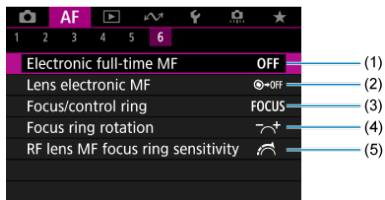

- (1) [Electronic full-time MF](#)
- (2) [Lens electronic MF](#)
- (3) [Focus/control ring](#)
- (4) [Focus ring rotation](#)
- (5) [RF lens MF focus ring sensitivity](#)

Tab Menus: AF (Movie Recording)

● AF1

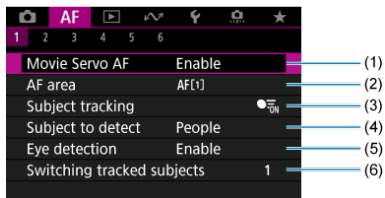

- (1) [Movie Servo AF](#)
- (2) [AF area](#)
- (3) [Subject tracking](#)
- (4) [Subject to detect](#)
- (5) [Eye detection](#)
- (6) [Switching tracked subjects](#)

Note

- When lenses without a focus mode switch are used, **[Focus mode]** is displayed on the **[AF1]** tab.

● AF2

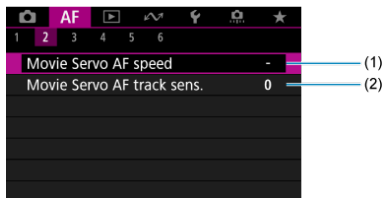

- (1) [Movie Servo AF speed](#)
- (2) [Movie Servo AF track sens.](#)

● AF3

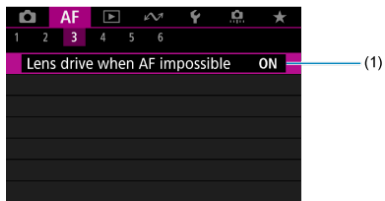

(1) [Lens drive when AF impossible](#)

● AF4

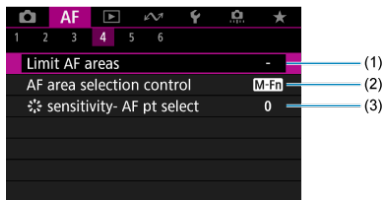

(1) [Limit AF areas](#)

(2) [AF area selection control](#)

(3) [sensitivity- AF pt select](#)

● AF5

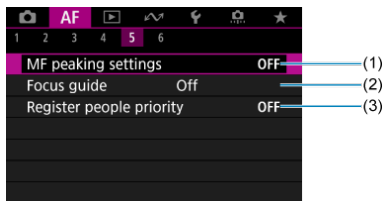

(1) [MF peaking settings](#)

(2) [Focus guide](#)

(3) [Register people priority](#)

● AF6

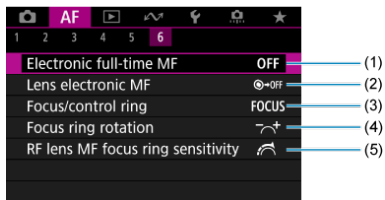

- (1) [Electronic full-time MF](#)
- (2) [Lens electronic MF](#)
- (3) [Focus/control ring](#)
- (4) [Focus ring rotation](#)
- (5) [RF lens MF focus ring sensitivity](#)

AF Operation

[One-Shot AF for Still Subjects](#)

[Servo AF for Moving Subjects](#)

You can select the AF operation characteristics to suit the shooting conditions or subject.

1. Set the lens's focus mode switch to <AF>.

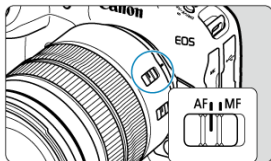

2. Select [AF: AF operation].

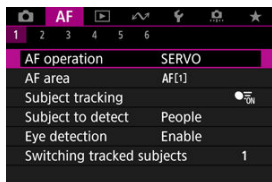

3. Select an option.

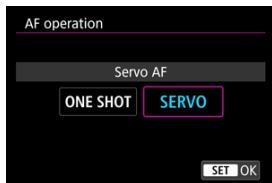



Note

- If focus is not achieved, the AF point will turn orange. With One-Shot AF, shooting is not possible even by pressing the shutter button completely. Recompose the shot and try to focus again. Or, see [Shooting Conditions That Make Focusing Difficult](#).
- With Servo AF, the camera shoots even when subjects are not in focus.

One-Shot AF for Still Subjects

This AF operation is suited for still subjects. When you press the shutter button halfway, the camera will focus only once.

- When focus is achieved, the AF point will turn green and the beeper will sound.
- The focus remains locked while you hold down the shutter button halfway, allowing you to recompose the image before taking the picture.
- For details on the continuous shooting speed for continuous shooting, see [Selecting the Drive Mode](#).



Note

- If [**Beep**] is set to [**Disable**], the beeper will not sound when focus is achieved.
- See [Lens electronic MF](#) when using a lens that supports electronic manual focusing.

Servo AF for Moving Subjects

This AF operation is suited for moving subjects. While you hold down the shutter button halfway, the camera will keep focusing on the subject continuously.

- When focus is achieved, the AF point will turn blue. The beeper will not sound even when focus is achieved.
- The exposure is set at the moment the picture is taken.
- For details on the continuous shooting speed for continuous shooting, see [Selecting the Drive Mode](#).

Caution

- Accurate focusing may not be possible at high aperture values or depending on the lens, the distance to the subject, and how fast the subject is moving.
- Zooming during continuous shooting may throw off the focus. Zoom first, then recompose and shoot.
- Consider shooting with One-Shot AF if Servo AF operation is unsteady for still subjects.

Movie Servo AF

With this function enabled, the camera focuses on the subject continuously during movie recording.

1. Set the still photo shooting/movie recording switch to <  >.

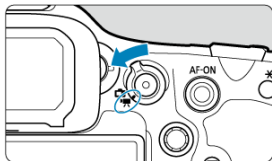



2. Select [**AF**: Movie Servo AF].

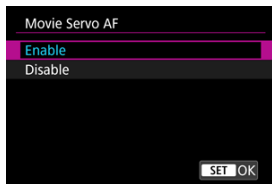

3. Select [Enable].



● Enable

- The camera focuses on the subject continuously even when you are not pressing the shutter button halfway.
- To keep the focus at a specific position, or if you prefer not to record mechanical sounds from the lens, you can temporarily stop Movie Servo AF by tapping [] in the lower left of the screen.
- Movie Servo AF will resume after pausing if you return to movie recording after operations such as pressing the < MENU > or <  > button or changing the AF area.

● Disable

While you hold down the shutter button halfway, the camera will keep focusing on the subject continuously. Pressing the < AF-ON > button focuses only once.

 **Caution**

Precautions when set to [Movie Servo AF: Enable]

- **Shooting conditions that make focusing difficult**
 - A fast-moving subject approaching or moving away from the camera.
 - A subject moving at a close distance to the camera.
 - When shooting with a higher aperture value.
 - Also see [Shooting Conditions That Make Focusing Difficult](#).
- Since the lens is driven continuously and the battery power is consumed, the possible movie recording time (🕒) will be shortened.
- The camera's built-in microphone may also record mechanical sounds of the lens or sounds of camera/lens operations if AF operations are performed or the camera or lens is operated during movie recording. In this case, using an external microphone may reduce these sounds. If the sounds are still distracting with an external microphone, it may be more effective to remove the external microphone from the camera and position it away from the camera and lens.
- Movie Servo AF pauses during zooming or magnified view.
- During movie recording, if a subject approaches or moves away or if the camera is moved vertically or horizontally (panning), the recorded image may momentarily expand or contract (change in image magnification).

Selecting the AF Area

- [AF Area](#)
- [Selecting the AF Area](#)
- [Subject Tracking](#)
- [Subject to Detect](#)
- [Eye Detection](#)
- [Switching Tracked Subjects](#)
- [Tracking with the < M-Fn2 > Button](#)
- [Manually Setting AF Points or Zone AF Frames](#)
- [Registering AF Points \(Home Position\)](#)
- [Magnified View](#)
- [AF Shooting Tips](#)
- [Shooting Conditions That Make Focusing Difficult](#)
- [AF Range](#)

AF Area

This section describes AF area operation with [**AF: Subject tracking**] set to [**Off**].

Spot AF

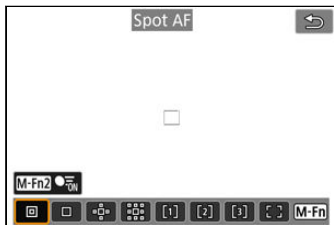

The camera focuses in a narrower area than 1-point AF.

1-point AF

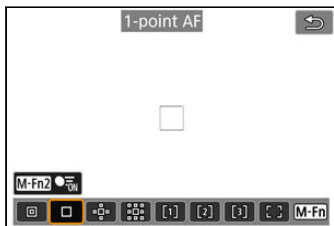

The camera focuses using a single AF point [].

Expand AF area:

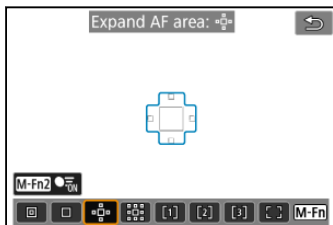



Focuses using one AF point  and the AF area outlined here in blue. Effective for moving subjects, which are difficult to track with 1-point AF.

Focusing on your preferred subject is easier than with Flexible Zone AF.

When Servo AF is used, first you will focus using an AF point .

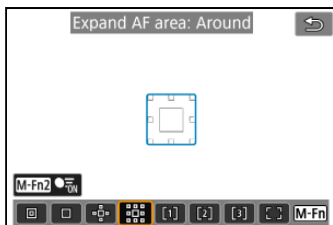
Expand AF area: Around



Focuses using one AF point  and the surrounding AF area outlined here in blue, which makes it easier to focus on moving subjects than with Expand AF area: .

When Servo AF is used, first you will focus using an AF point .

[1]: Flexible Zone AF 1 (default)

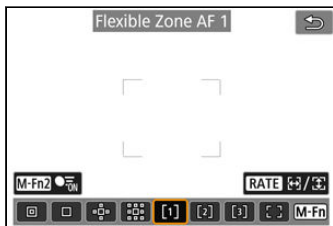

With Flexible Zone AF 1, you can freely set the size of the Zone AF frame [] ().
Uses auto selection AF in Zone AF frames to cover a larger area than Expand AF area, which makes focusing easier than with 1-point AF/Expand AF area and effective for moving subjects.

By default, a square Zone AF frame is set.

Focusing areas are determined not only based on the nearest subject but also based on a variety of other conditions such as faces (of people or animals), vehicles, subject motion, and subject distance.

Pressing the shutter button halfway displays [] over AF points in focus.

[2]: Flexible Zone AF 2

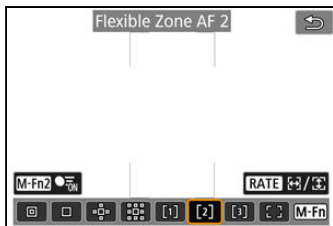

With Flexible Zone AF 2, you can freely set the size of the Zone AF frame [] ().

Uses auto selection AF in Zone AF frames to cover a larger area than Expand AF area, which makes focusing easier than with 1-point AF/Expand AF area and effective for moving subjects.

By default, a vertical rectangular Zone AF frame is set.

Focusing areas are determined not only based on the nearest subject but also based on a variety of other conditions such as faces (of people or animals), vehicles, subject motion, and subject distance.

Pressing the shutter button halfway displays [] over AF points in focus.

[3]: Flexible Zone AF 3

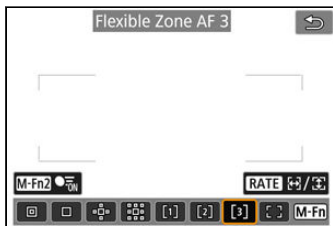

With Flexible Zone AF 3, you can freely set the size of the Zone AF frame [] (). Uses auto selection AF in Zone AF frames to cover a larger area than Expand AF area, which makes focusing easier than with 1-point AF/Expand AF area and effective for moving subjects.

By default, a horizontal rectangular Zone AF frame is set.

Focusing areas are determined not only based on the nearest subject but also based on a variety of other conditions such as faces (of people or animals), vehicles, subject motion, and subject distance.

Pressing the shutter button halfway displays [] over AF points in focus.

[]: Whole area AF

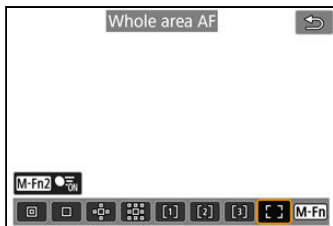

Uses auto selection AF in a whole-area AF frame to cover a larger area than Flexible Zone AF, which makes focusing easier than with 1-point AF/Expand AF area/Flexible Zone AF and effective for moving subjects.

Focusing areas are determined not only based on the nearest subject but also based on a variety of other conditions such as faces (of people or animals), vehicles, subject motion, and subject distance.

Pressing the shutter button halfway displays [] over AF points in focus.

Selecting the AF Area

You can select the AF area to suit the shooting conditions or subject. If you prefer to focus manually, see [Manual Focus](#).

1. Select [AF: AF area].

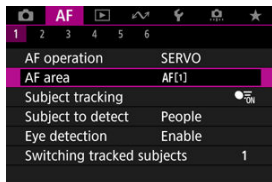

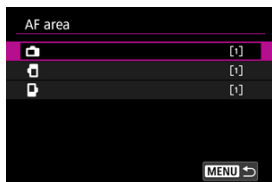
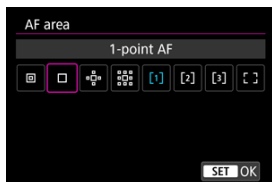

2. Select the AF area.



- The screen above is displayed when **[AF: Orientation linked AF point] (☑)** is set to **[Separate AF pts: Area+pt]**. Set separate AF areas after choosing vertical and horizontal orientations.



Note

- To set the AF area, you can also press the <  > button and then the < M-Fn > button.
- The following descriptions apply to the camera with AF operation set to [Servo AF] (). Once a subject is in focus with [One-Shot AF] (), the AF point turns green.

Subject Tracking

Among the subjects detected, a tracking frame [] is displayed over the main subject. If the subject moves, the tracking frame [] also moves to track it.

You can set [**AF: Eye detection**] to [Enable] to shoot with the subject's eyes in focus ().

1. Select [**AF: Subject tracking**].

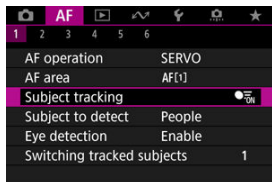

2. Select an option.

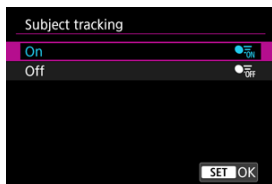

Caution

- No tracking frame is displayed when [**AF: Subject tracking**] is set to [Off], regardless of the [**AF: Subject to detect**] setting.

Manually selecting a subject for focus

1. Check the tracking frame.





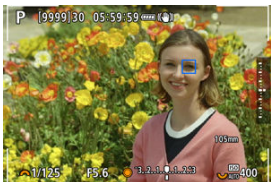
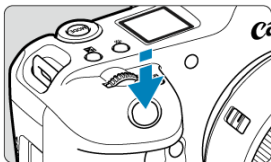

- A tracking frame [] appears over detected subjects.
- Unless the tracking frame [] overlaps an AF point, it is displayed in gray.
- Once the tracked subject is behind or inside an AF point, the tracking frame turns white (distinguishing it as an active frame), enabling selection as the main subject.
- Tracking frames are also white outside of an AF point as long as part of a subject is detected in the AF point and part of the subject (such as eyes, face, or head) lies within the range of Whole area AF.
- Gray display of tracking frames [] does not apply in movie recording.

2. Focus and shoot/record.



- Once you press the shutter button halfway and the subject is in focus, the AF point turns blue. An orange AF point indicates that the camera could not focus on subjects.
- Subjects are tracked across the entire screen as you press the shutter button halfway or completely.

Note

- Selecting a subject manually after pressing the < **M-Fn2** > button changes the tracking frame to  and locks on to that subject for tracking across the entire screen regardless of the specified AF area.
- Selecting a subject by touch with [**AF: AF area**] set to [**Whole area AF**] changes the tracking frame to  and locks on to that subject for tracking across the entire screen.
- To release locked tracking, tap  or press the < **M-Fn2** > button. After release, the AF point reverts to the position set before release.
- Pressing the shutter button halfway when the AF point does not overlap the tracking frame  will focus in the AF point.
- When AF operation is set to Servo AF, pressing the shutter button halfway focuses using Whole area AF.
- For human subjects, the active  may cover only a part of the face, not the whole face.
- The size of tracking frames varies depending on the subject.
- No tracking frame is displayed when [**AF: Subject tracking**] is set to [**Off**], regardless of the [**AF: Subject to detect**] setting.

Caution

- Tapping the screen to focus will focus with [**One-Shot AF**], regardless of the AF operation setting.
- Faces cannot be detected when subjects are greatly out of focus. Focus manually () to bring the subject's face into position for detection, then continue with AF.
- AF may not detect subjects or people's faces at the edges of the screen. Before shooting, recompose the shot to center or roughly center the subject or AF point.

Subject to Detect

You can specify conditions for automatic selection of the main subject to track.

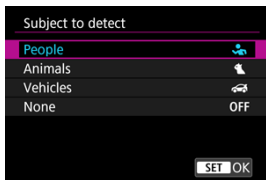

- **People**

Prioritizes the faces or heads of people as the main subjects to track.

When a person's face or head cannot be detected, the camera attempts to detect and track their torso. If their torso cannot be detected, the camera may track other parts of their body.

- **Animals**

Detects animals (dogs, cats, or birds) and people and prioritizes detection results for animals as the main subjects to track.

For animals, the camera attempts to detect faces or bodies, and a tracking frame is shown over any face detected.

When an animal's face or entire body cannot be detected, the camera may track part of their body.

- **Vehicles**

Detects two- or four-wheeled motorsports vehicles and people and prioritizes detection results for vehicles as the main subjects to track.

For vehicles, the camera attempts to detect key details or the entire vehicle, and a tracking frame is shown over any of these details detected.

If key details or the entire vehicle cannot be detected, the camera may track other parts of the vehicle.

Press the <INFO> button to enable or disable Spot detection for key details of vehicles.

- **None**

The camera determines the main subject automatically from how you compose shots, without detecting subjects.

Tracking frames are not displayed.

 **Caution**

- The camera may detect areas other than faces or bodies of people or animals or key details or bodies of vehicles as subjects.
- Faces that are very small or large in the picture, too bright or dark, or partly hidden cannot be detected.
- Animal face detection is not possible unless the subject is close enough and facing the camera steadily. A tracking frame is displayed for the entire body.
- Detection is not possible for birds camouflaged in a forest, or similar situations.
- Detection may not be possible for ordinary passenger cars or bicycles, or for motorcyclists performing stunts or kicking up dirt and dust.
- No tracking frame is displayed when [**AF: Subject tracking**] is set to [**Off**], regardless of the [**AF: Subject to detect**] setting.

 **Note**

- You can choose the following subjects by pressing the shutter button halfway or when [Tracking with the < M-Fn2 > Button](#). In scenes without relevant subjects, the camera tracks other objects.
 - **People**
People, animals, vehicles
 - **Animals**
People, animals
 - **Vehicles**
People, vehicles

Eye Detection

You can shoot with the eyes of people or animals in focus.

1. Select **[AF: Eye detection]**.

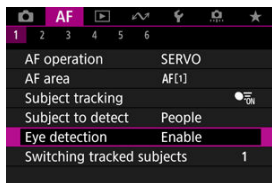

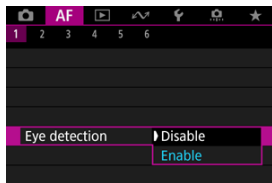

2. Select an option.

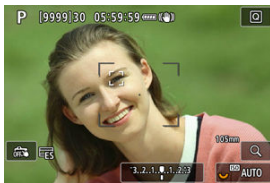

3. Aim the camera at the subject.



- A tracking frame is displayed around their eye.
- To choose an eye to focus on when **[AF: AF area]** is set to **[Whole area AF]**, press the <  > button to change the tracking frame to , then use < * >. As you use < * >, the tracking frame changes again to .
- You can also tap the screen to choose an eye, when **[AF: AF area]** is set to **[Whole area AF]** or during tracking in progress.
- If your selected eye is not detected, an eye to focus on is selected automatically.

4. Take the picture.

Caution

- Subject eyes may not be detected correctly, depending on the subject and shooting conditions.
- No tracking frame is displayed when **[AF: Subject tracking]** is set to **[Off]**, regardless of the **[AF: Subject to detect]** setting.
- Eyes are not detected when **[AF: Subject to detect]** is set to **[None]**.

Switching Tracked Subjects

You can specify how easily the camera switches AF points to track subjects.

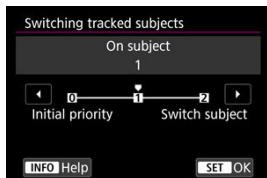

- **Initial priority**
Tracks the subject initially determined for AF, to the extent possible.
- **On subject**
Tracks the subject initially determined for AF, to the extent possible. Switches to other subjects if the camera can no longer determine if the tracked subject is the main subject.
- **Switch subject**
Switches to track other subjects in response to shooting conditions.

! Caution

Precautions when set to [Initial priority]

- The camera may not be able to continue tracking subjects under some subject conditions.
 - If subjects move vigorously
 - If subjects face a different direction or change their posture
 - If the tracking frame strays from subjects, or if subjects are hidden behind obstructions and you can no longer see them
- Subjects selected by touch operations are tracked to the extent possible, regardless of the **[AF: Subject to detect]** setting.

Tracking with the <M-Fn2> Button

You can press the <M-Fn2> button to track subjects with a tracking frame [F6].

1. Check the AF point.





(1)

- The AF point (1) will appear.
- With Expand AF area: "□" or Expand AF area: Around, adjacent AF points are also displayed.
- With Flexible Zone AF, the specified Zone AF frame is displayed.

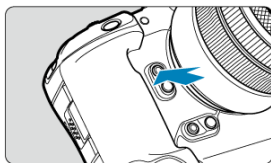
2. Press the <M-Fn2> button.



- The AF point changes to a tracking frame [], which locks on to that subject for tracking and follows the subject within the screen if it moves. To cancel tracking, press the <M-Fn2> button again.
- The tracking frame changes to [] when multiple subjects can be detected, and you can use <  > to choose a subject to focus on.
- Once tracking begins, the subject is tracked across the entire screen, regardless of the specified AF area.
- The position of AF areas and points when tracking stops after you press the shutter button halfway or completely corresponds to the position of the tracking frame during tracking. The position of AF areas and points when tracking stops during shooting standby corresponds to the position before tracking.

3. Take the picture.

Manually Setting AF Points or Zone AF Frames

You can manually set the AF point or Zone AF frame. Here, Flexible Zone AF 1 screens are used as an example.

1. Check the AF point.



(1)

- The AF point (1) will appear.
- With Expand AF area: "□" or Expand AF area: Around, adjacent AF points are also displayed.
- With Flexible Zone AF, the specified Zone AF frame is displayed.

2. Move the AF point.

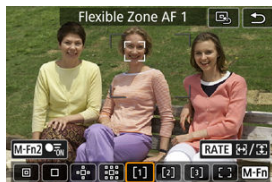

- Press the $\langle \text{Grid} \rangle$ button, use $\langle \text{Star} \rangle$ to move the AF point into position for focusing, then press $\langle \text{SET} \rangle$ (but note that with some lenses, it may not move to the edge of the screen).
- To center the AF point while using $\langle \text{Star} \rangle$, press $\langle \text{Star} \rangle$ straight in.
- You can also focus by tapping a position on the screen.
- To center the AF point or Zone AF frame, tap $\langle \text{Grid} \rangle$ or press $\langle \text{Star} \rangle$ straight in.
- You can resize Zone AF frames used for Flexible Zone AF by pressing the $\langle \text{RATE} \rangle$ button. Adjust the horizontal size with the $\langle \text{Dial with Plus} \rangle$ dial and vertical size with the $\langle \text{Dial with Minus} \rangle$ dial, then press $\langle \text{SET} \rangle$. To restore the default Zone AF frame size, press the $\langle \text{INFO} \rangle$ button.

3. Focus and take the picture.

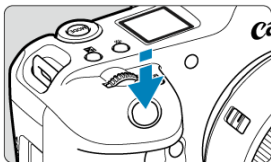

- Aim the AF point over the subject and press the shutter button halfway.



- When focus is achieved, the AF point turns blue.
- If focus is not achieved, the AF point will turn orange.

Caution

- The camera will keep moving the AF point (□) to track subjects when set to Flexible Zone AF and Servo AF, but under some shooting conditions (such as when subjects are small), it may not be possible to track the subject.
- Focusing may be difficult when using a peripheral AF point. In this case, select an AF point in the center.
- Tapping the screen to focus will focus with [One-Shot AF], regardless of the AF operation setting.

Note

- You can set AF areas and AF points when [AF: Orientation linked AF point] is set to [Separate AF pts: Area+pt] (🔗).

Registering AF Points (Home Position)

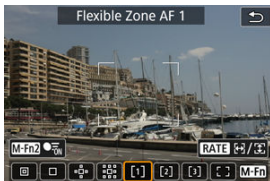

You can register the position of a frequently used AF point. For instant switching from the current AF point to your registered AF point, you can use a button you assign to recalling the home position on advanced setting screens for **[Direct AF point selection]**, **[Metering and AF start]**, **[Switch to registered AF point]**, or **[Register/recall shooting func]** in **[Customize buttons]** (☑).

1. Select your preferred AF area.







- Press the <  > button to select an AF area.
- Move the AF point or Zone AF frame to the position to register.

2. Register the AF point or Zone AF frame.

- Hold down the <  > button and press the <  > button, or press and hold the <  > button, so that the camera beeps and registers the AF point.
- The registered AF point blinks in gray.
- Registration when the camera is set to Whole area AF will register the entire AF area as the home position.

 **Note**

- To clear registered AF points, hold down the <  > button and press the <  > button, or press and hold the <  > button.
- You can also clear registered AF points by clearing all camera settings.
- You can register separate home positions for each camera orientation when the orientation-linked AF point setting () is set to **[Separate AF pts: Area+pt]** or **[Separate AF pts: Pt only]**.
- Although it has no effect if you attempt to register a home position while a subject is being tracked with a tracking frame, you can clear registered positions at this time.

Magnified View

To check the focus, you can magnify display by approx. 5× or 10× by pressing the <Q> button (or tapping [Q]).

- Magnification is centered on the AF point for [Spot AF], [1-point AF], [Expand AF area: □], and [Expand AF area: Around], or on the Zone AF frame for Flexible Zone AF.
- Autofocusing is performed in magnified view if you press the shutter button halfway.
- When set to Servo AF, pressing the shutter button halfway in magnified view reverts to the normal view for focusing.
- Magnification is centered on the tracking frame when [AF: Subject tracking] is set to [On] and the tracking frame [] is white (as an active frame), or when you are tracking with the <M-Fn2> button (📷).

⚠ Caution

- If focusing is difficult in the magnified view, return to the normal view and perform AF.
- If you perform AF in the normal view and then use the magnified view, accurate focus may not be achieved.
- AF speed differs between the normal view and magnified view.
- Preview AF and Movie Servo AF are not available in magnified view.
- With the magnified view, achieving focus becomes more difficult due to camera shake. Using a tripod is recommended.

AF Shooting Tips

- Even when focus is achieved, pressing the shutter button halfway will focus again.
- Image brightness may change before and after autofocusing.
- Depending on the subject and shooting conditions, it may take longer to focus, or the continuous shooting speed may decrease.
- If the light source changes as you shoot, the screen may flicker, and focusing may be difficult. In this case, restart the camera and resume shooting with AF under the light source you will use.
- If focusing is not possible with AF, focus manually (☑).
- For subjects at the edge of the screen that are slightly out of focus, try centering the subject (or AF point, or Zone AF frame) to bring them into focus, then recompose the shot before shooting.
- With certain lenses, it may take more time to achieve focus with autofocus, or accurate focusing may not be achieved.

Shooting Conditions That Make Focusing Difficult

- Subject with low-contrast such as the blue sky, solid-color flat surfaces or when highlight or shadow details are clipped.
- Subjects in low light.
- Stripes and other patterns where there is contrast only in the horizontal direction.
- Subjects with repetitive patterns (Example: Skyscraper windows, computer keyboards, etc.).
- Fine lines and subject outlines.
- Under light sources with constantly changing brightness, colors, or patterns.
- Night scenes or points of light.
- The image flickers under fluorescent or LED lighting.
- Extremely small subjects.
- Subjects at the edge of the screen.
- Strongly backlit or reflective subjects (Example: Car with a highly reflective surfaces, etc.).
- Near and distant subjects covered by an AF point (Example: Animal in a cage, etc.).
- Subjects that keep moving within the AF point and will not stay still due to camera shake or subject blur.
- Performing AF when the subject is very far out of focus.
- Soft focus effect is applied with a soft focus lens.
- A special effect filter is used.
- Noise (dots of light, banding, etc.) appears on the screen during AF.

AF Range

The available autofocus range varies depending on the lens, aspect ratio, and image quality used, and whether you are shooting 4K movies or using features such as Movie cropping or Movie digital IS.

Manual Focus

[✔ Setting MF peaking \(Outline Emphasis\)](#)

[✔ Focus Guide](#)

If focusing is not possible with autofocus, you can magnify the image and focus manually.

1. Set the lens's focus mode switch to <MF>.

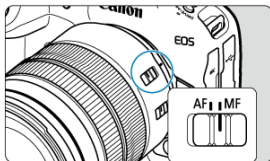

- Turn the lens focusing ring to set the approximate focus.
- For lenses without a focus mode switch, set [**AF**: Focus mode] to [MF].

2. Magnify the image.



- Each press of the <Q> button changes the magnification ratio, as follows.

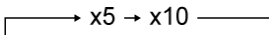

3. Move the magnified area.



- Use < * > to move the magnified area into position for focusing.
- To center the magnified area, press < * > straight in.

4. Focus manually.

- While looking at the magnified image, turn the lens focusing ring to focus.
- After achieving focus, press the < Q > button to return to the normal view.



Note

- In magnified view, the exposure is locked.
- Even when focusing manually, you can use Touch Shutter to shoot.

Setting MF peaking (Outline Emphasis)

Edges of subjects in focus can be displayed in color to make focusing easier. You can set the outline color and adjust the sensitivity (level) of edge detection.

1. Select [**AF**: MF peaking settings].

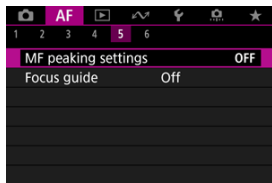

2. Select [**Peaking**].

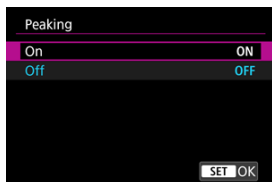

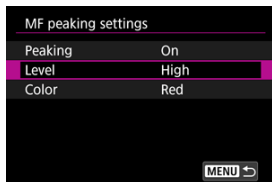

- Select [**On**].

3. Set [**Level**] and [**Color**].



- Set as necessary.

 **Caution**

- In magnified view, peaking display is not shown.
- During HDMI output, peaking display is not shown on equipment connected via HDMI. Note that peaking display is shown on the camera screen when [: **HDMI display**] is set to [].
- MF peaking may be hard to discern at high ISO speeds, especially when ISO expansion is set. If necessary, lower the ISO speed or set [**Peaking**] to [**Off**].

 **Note**

- Peaking display shown on the screen is not recorded in images.
- MF peaking may be hard to discern when Canon Log is set. If necessary, set [**View Assist.**] to [**On**].

Setting **[AF: Focus guide]** to **[On]** provides a guide frame that shows which direction to adjust focus and the extent of adjustment needed. You can also use eye control to display the focus guide at your preferred position. For details, see [Using Eye Control for AF](#).

1. Select **[AF: Focus guide]**.

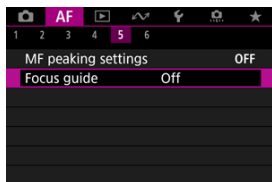

2. Select **[On]**.

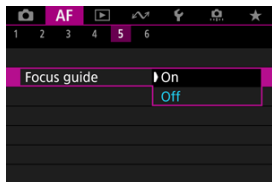

- The guide frame is displayed on the face of any person detected as the main subject.
- To display the guide frame near the eyes of any person detected as the main subject, set **[AF: Subject tracking]** to **[On]** and **[AF: Eye detection]** to **[Enable]**.
- After pressing the **[< i>+</i> >** button, you can use **< i>* >** to move the guide frame in the direction you press.
- To center the guide frame while using **< i>* >**, press **< i>* >** straight in.
- To set the guide frame after moving it with **< i>* >**, press **< i>SET >**.
- You can also move and set the guide frame by tapping the screen.
- To center the guide frame, tap **[< i>B >**] or press **< i>* >** straight in.

The guide frame indicates the current position in focus and adjustment amount as follows.

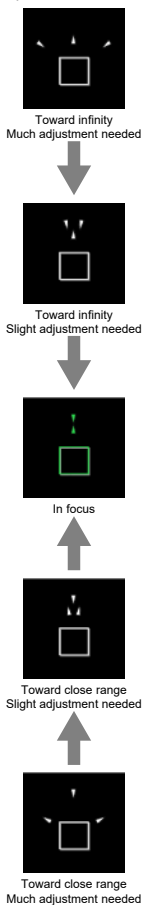

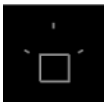

Adjustment information
not detected

! Caution

- Under difficult shooting conditions for AF (AF-ON), the guide frame may not be displayed correctly.
- Higher aperture values are more likely to prevent correct guide frame display.
- No AF points are displayed while the guide frame is displayed.
- The guide frame is not displayed in these situations.
 - When the lens's focus mode switch is set to < AF >
 - When display is magnified
- The guide frame is not displayed correctly during shifting or tilting of TS-E lenses.

📄 Note

- The camera's auto power off counter does not count time spent adjusting the focus with a lens's electronic focusing ring.

Registering People to Prioritize

- [Registering Faces](#)
- [Changing or Removing the Priority of Registered People](#)
- [Disabling Detection of Registered People's Faces](#)
- [Clearing All Registered People](#)
- [Saving and Loading Registered Data](#)

You can register people on the camera to have the camera attempt to detect their faces and prioritize focusing, brightness, and color tone for them when you shoot. To register a face, you can take a picture of someone, or you can use an image on the card.

Caution

- The camera stores face images and related information registered using this feature. Delete all registered information before disposing of the camera or transferring ownership.
- When using this feature, be aware of the need to protect personal information and comply with privacy regulations, as by asking people for their consent before registering their information. Canon cannot be held liable for any personal information issues arising from use of this feature.

Registering people by taking their picture

1. Select [**AF**: Register people priority].

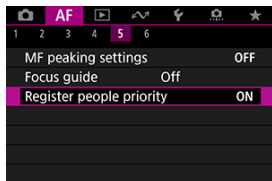

2. Select [**Photograph people and register**].

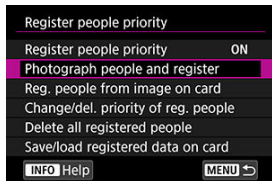

3. Aim the frame over the face of a person to register, then take their picture.

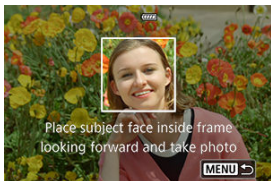

- Shoot under ample light with the subject facing you.
- Ask subjects to pose with a natural facial expression before you shoot.
- For best results, ask subjects to take off any hats, masks, sunglasses, or other coverings before you take their picture.
- It may improve detection accuracy to register faces immediately before you will shoot.
- Under these shooting conditions, detection may be less accurate, and it may not be possible to register faces.
 - Faces are too small, relative to the frame
 - Faces are hidden behind hair or thick-framed glasses
 - Faces are partially shaded
 - Faces are displayed on a computer or smartphone screen

4. Select [OK].

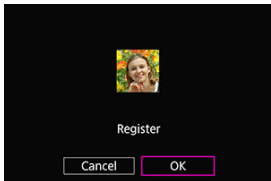

- The image displayed may look different from how you composed the shot in step 3, but this will not affect detection accuracy.

Registering people from images on the card

JPEG or HEIF images can be used. Process any RAW images you will use into JPEGs or HEIFs before saving them to the card.

Caution

- With the following images, detection may be less accurate, and it may not be possible to register faces.
 - Faces are hidden behind hair or thick-framed glasses
 - Faces are partially shaded
 - Faces are displayed on a computer or smartphone screen

Note

- For best results, make sure that faces in the images meet these guidelines.
 - Well lit and facing you
 - Not wearing any hats, masks, sunglasses, or other coverings
 - Natural facial expression
 - Faces are not too small or large relative to the screen

1. Select [Reg. people from image on card].

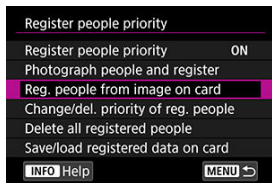

2. Switch to playback.



- Press < SET >.

3. Select a face.

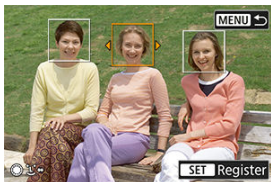

- For pictures that show more than one person, you can use the < [person icon] > < [dials icon] > dials or < [snowflake icon] > to move the orange frame over the face to register.
- Press < SET >.

4. Select [OK].

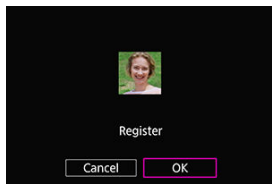

- After the following screen appears, you can register another person's face.

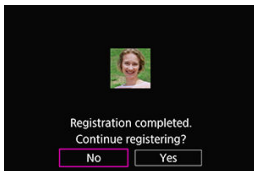

Display when registered faces are detected

A white frame with [👤] appears on any registered faces that are detected on the shooting screen. Note that [👤] is not displayed when One-Shot AF or Servo AF is used.

Caution

- Detection may be less accurate under these conditions.
 - Subjects are not directly facing you
 - Faces are too light or dark
 - Faces are too small or large relative to the screen
 - Subjects have a much different facial expression from the one in registered images
 - Subjects are moving too much
 - Faces are covered by a hat, mask, sunglasses, or other objects
 - Subject faces look much different from how they look in registered images
 - Faces displayed on a computer or smartphone screen were photographed to register them
- Unregistered people may be mistakenly detected as registered people whom they resemble.
- If faces of registered people are not detected, or if detection is not accurate, try clearing the registered information and registering it again.

Note

- When [**AF: Subject to detect**] is set to an option other than [**People**], priority is given to the subject specified in that setting.
- The following table may be useful when configuring [**AF: Switching tracked subjects**].

Setting	Initial priority	On subject	Switch subject
In still photo shooting	Even unregistered subjects detected initially during Servo AF will continue to be tracked as long as possible.		Tracking during Servo AF switches to people to whom you have assigned high priority for detection.
In movie recording	Even unregistered subjects detected when you start shooting will continue to be tracked as long as possible.		Tracking as you shoot switches to people to whom you have assigned high priority for detection.

Changing or Removing the Priority of Registered People

You can change detection priority by rearranging registered people. You can also remove registered people.

Changing detection priority

1. Select [Change/del. priority of reg. people].

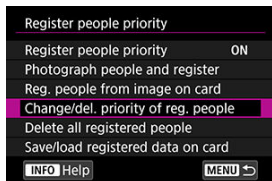

2. Select the face of a registered person.

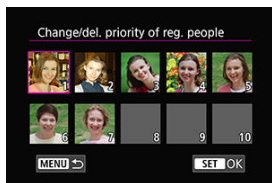

- Select with the <⌚> <☺> dials or <✱>, then press <Ⓢ>.

3. Change the priority.

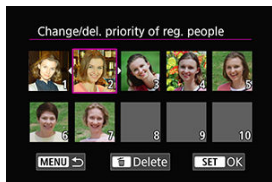

- Move with the <⌚> <☺> dials or <✳>, then press <SET>.
- When finished changing priority, press the <MENU> button.

Removing registered people

1. Select the face of a registered person.

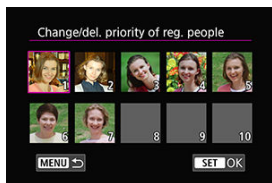

- Select with the <⌚> <☺> dials or <✳>, then press <SET>.

2. Press the <🗑️> button.

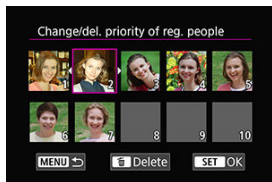

3. Select [OK].

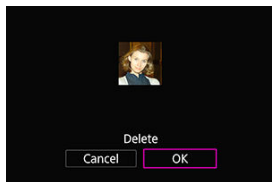

- Press the < MENU > button to exit.

Disabling Detection of Registered People's Faces

Select **[Register people priority]** and then **[Disable]**.

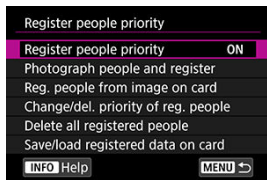

Clearing All Registered People

Delete all registered information before disposing of the camera or transferring ownership.

1. Select [Delete all registered people].

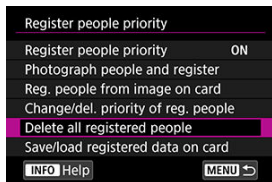

2. Press < (SET) >.

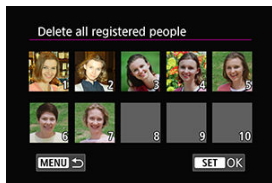

3. Select [OK].



- Press <  >.

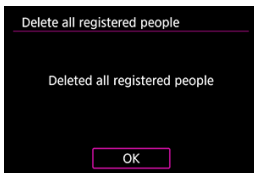

Note

- Performing [**Factory reset**] in [: **Reset camera**] also clears the information for all registered people.

Saving and Loading Registered Data

Registered face data can be saved to a card. By loading face data from cards of other EOS R3 cameras, you can also apply the same settings as used by those cameras.

1. Select [Save/load registered data on card].

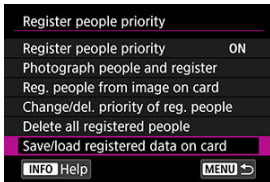

2. Select [Save to card].

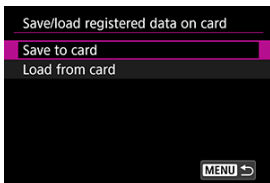

- Select [**Save to card**] to save the camera's registered data to the card.
- To rename the registered data file before saving it, press the < **INFO** > button on the following screen.



- Select [**Load from card**] to load registered data from the card.

 **Caution**

- Confirm that the camera can load the registered data from the card.
- If not, use images that are not affected by the following issues and confirm that the camera can load them when you try to register people again.
 - Faces are hidden behind hair or thick-framed glasses
 - Faces are partially shaded
 - Faces are displayed on a computer or smartphone screen

Servo AF Characteristics



- [Case Details](#)
- [Case 1: Versatile Multi-Purpose Setting](#)
- [Case 2: Continue to Track Subjects, Ignoring Possible Obstacles](#)
- [Case 3: Instantly Focus on Subjects Suddenly Entering AF Points](#)
- [Case 4: For Subjects That Accelerate or Decelerate Quickly](#)
- [Case A: Tracking Automatically Adapts to Subject Movement](#)
- [Parameters](#)
- [Adjusting Case Parameters](#)

Shooting with Servo AF can be easily tailored to your subjects or shooting situations by selecting a Case option. This feature is called the "AF Configuration Tool."

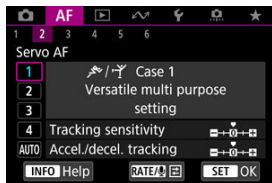
1. Select the [AF2] tab.







2. Select a case.

- Turn the <  > dial to select a case icon, then press <  >.
- Your selected case is now set. Selected cases are displayed in blue.

Case Details

Case 1 to Case A are five combinations of settings for “[Tracking sensitivity](#)” and “[Acceleration/deceleration tracking](#).” Referring to the following table, select the case for your subject and shooting situation.

Case	Icon	Description	Examples of Shooting Situations
Case 1		Versatile multi purpose setting	Moving subjects in general
Case 2		Continue to track subjects, ignoring possible obstacles	Tennis, freestyle skiing
Case 3		Instantly focus on subjects suddenly entering AF points	Start of a cycling race, downhill skiing
Case 4		For subjects that accelerate or decelerate quickly	Soccer, rhythmic gymnastics, motorsports, basketball
Case A		Tracking automatically adapts to subject movement	Moving subjects in general, especially in dynamic shooting situations

Case 1: Versatile Multi-Purpose Setting

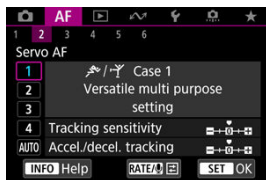

Default

- **Tracking sensitivity:** 0
- **Accel./decel. tracking:** 0

Standard setting suited to moving subjects in general. Suitable for many kinds of subjects and scenes.

In the following situations, select [Case 2] to [Case 4] instead: non-subjects moving across AF points, elusive subjects, or subjects that suddenly appear or change speed.

Case 2: Continue to Track Subjects, Ignoring Possible Obstacles

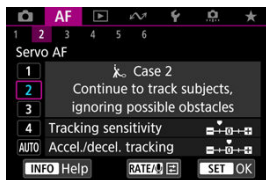

Default

- **Tracking sensitivity:** Locked on: -1
- **Accel./decel. tracking:** 0

Setting to continue focusing on the subject even if non-subjects move across AF points, or if the subject strays from AF points. Effective if you prefer the focus not to switch to non-subjects or the background.

Note

- Try setting [**Tracking sensitivity**] to [-2] if non-subjects tend to steal the focus or AF points tend to stray from the subject much of the time, preventing the camera from tracking the target subject under default settings (🔗).

Case 3: Instantly Focus on Subjects Suddenly Entering AF Points

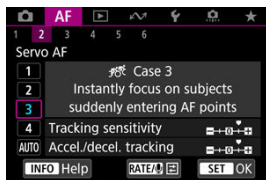

Default

- **Tracking sensitivity: Responsive: +1**
- **Accel./decel. tracking: +1**

Setting to focus on a series of subjects at different distances in the AF points, one after another. Focus switches to any new subject that appears in front of the target subject. Also effective when you want to always focus on the closest subject.

Note

- Try setting [**Tracking sensitivity**] to [**+2**] if you prefer focusing that immediately switches to new subjects that appear suddenly (👉).

Case 4: For Subjects That Accelerate or Decelerate Quickly

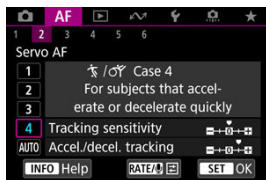

Default

- Tracking sensitivity: Responsive: 0
- Accel./decel. tracking: +1

Setting to keep tracking and focusing on subjects even if they suddenly change speed. Effective for subjects having sudden movements, sudden acceleration/deceleration, or sudden stops.

Note

- Try setting [**Accel./decel. tracking**] to [**+2**] to keep up with subjects that change speed significantly from moment to moment (🔗).

Case A: Tracking Automatically Adapts to Subject Movement

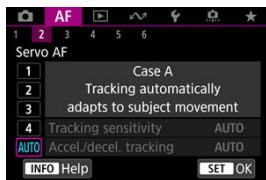

Useful when you prefer to shoot with parameters set automatically, based on how subjects change.

Tracking sensitivity and acceleration/deceleration tracking are set automatically.

Tracking sensitivity

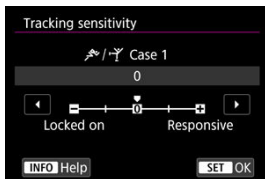

Setting for Servo AF subject-tracking sensitivity in response to non-subjects moving across AF points or subjects straying from AF points.

- **0**
Standard setting. Suitable for moving subjects in general.
- **Locked on: -2 / Locked on: -1**
The camera will try to continue focusing on the subject even if non-subjects move across AF points or if the subject strays from the AF points. The -2 setting makes the camera keep tracking the target subject longer than the -1 setting. However, if the camera focuses on a wrong subject, it may take slightly longer to switch and focus on the target subject.
- **Responsive: +2 / Responsive: +1**
The camera can focus consecutively on subjects at different distances that are covered by the AF points. Also effective when you want to always focus on the closest subject. The +2 setting is more responsive than the +1 setting when focusing on the next subject. However, the camera will be more prone to focus on an unintended subject.

Acceleration/deceleration tracking

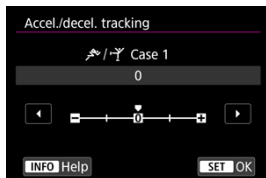

Setting for subject-tracking sensitivity in response to sudden, significant changes in speed, as when subjects suddenly start or stop moving.

- **0**
Suited for subjects that move at a steady speed (minor changes in moving speed).
- **-2 / -1**
Suited for subjects that move at a steady speed (minor changes in moving speed). Effective when a setting of 0 makes focus unstable, due to slight subject movement or an obstruction in front of the subject.
- **+2 / +1**
Effective for subjects having sudden movements, sudden acceleration/deceleration, or sudden stops. Even if the moving subject's speed suddenly changes significantly, the camera continues to focus on the target subject. For example, the camera is less likely to focus behind a subject that suddenly starts approaching you, or in front of an approaching subject that suddenly stops moving. Setting +2 can track dramatic changes in the moving subject's speed better than with +1.
However, since the camera will be sensitive to even slight movements of the subject, focusing may become unstable for short periods.

Adjusting Case Parameters

You can manually adjust the parameters ((1) Tracking sensitivity and (2) Acceleration/ deceleration tracking) for Case 1 to Case 4.

1. Select a case.

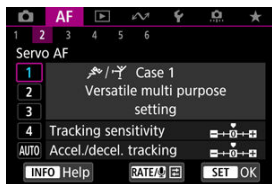

- Turn the <  > dial to select the number of a case to adjust.

2. Press the < RATE > button.

- The selected parameter is outlined in purple.

3. Select a parameter to adjust.

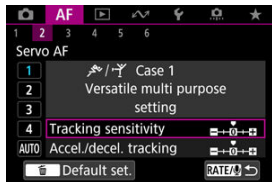

4. Make the adjustment.

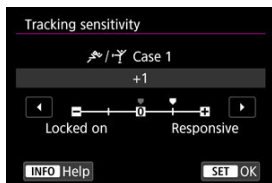

- Default settings are indicated by a light gray [] icon.
- To confirm the adjustment, press < SET >.
- To return to the screen in step 1, press the < RATE > button.

Note

- To restore default parameter settings for (1) and (2) to each case, press the < RATE > button in step 2, then press the < [] > button.
- You can also register (1) and (2) parameter settings to My Menu ([]). This enables you to adjust settings for the selected case.
- To shoot with a case you have adjusted, first select the adjusted case, then shoot.

Customizing AF Functions

☑ [\[AF3\]](#)

☑ [\[AF4\]](#)

☑ [\[AF6\]](#)

☑ [\[AF2\] \(In Movie Recording\)](#)

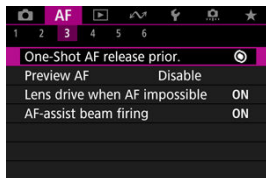

You can configure AF functions in detail to suit your shooting style or subject.

[AF3]

One-Shot AF release priority

You can specify whether to prioritize focus or release timing for One-Shot AF (except when shooting with Touch Shutter).

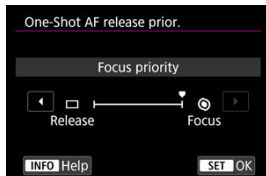

- **[Ⓞ] Focus**

The picture will not be taken until focus is achieved. Useful when you want to achieve focus before capturing the image.

- [] Release

Prioritizes shutter release over focus. Useful when capturing the decisive moment is most important.

Note that the camera shoots whether or not the subject is in focus.

Preview AF

This function keeps subjects generally in focus. The camera is ready to focus immediately when you press the shutter button halfway.

1. Select [AF: Preview AF].

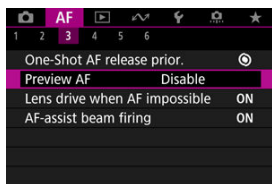

2. Select [Enable].

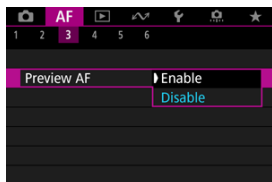

! Caution

- Fewer shots are available when set to [Enable], because the lens is driven continuously and battery power is consumed.

Lens operation when AF is not available

You can specify lens operation that applies when autofocusing on a subject is not possible.

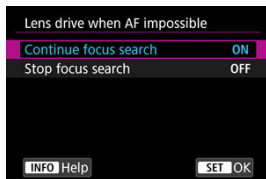

- **[ON] Continue focus search**

If focus cannot be achieved with autofocus, the lens is driven to search for the precise focus.

- **[OFF] Stop focus search**

If autofocus starts and the focus is far off or if focus cannot be achieved, the lens drive will not be performed. This prevents the lens from becoming grossly out of focus due to the focus search drive.

! Caution

- **[Stop focus search]** is recommended for super telephoto lenses or other lenses that are driven over a large focus area, to avoid significant delay from focus search drive if the lens becomes greatly out of focus.

AF-assist beam firing

You can enable or disable AF-assist beam firing of the camera or a Speedlite for EOS cameras.

1. Select **[AF: AF-assist beam firing]**.

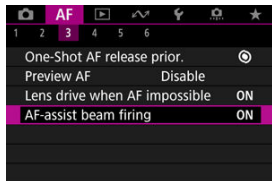

2. Select an option.

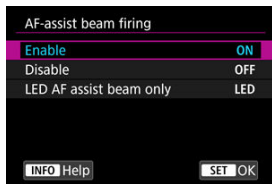

- **[ON] Enable**
Enables firing of the AF-assist beam, when needed.
- **[OFF] Disable**
Disables firing of the AF-assist beam. Set if you prefer not to fire the AF-assist beam.
- **[LED] LED AF assist beam only**
Enables LED AF-assist beam firing by Speedlites equipped with this feature, when these flash units are attached. If your Speedlite is not LED-equipped, the camera's AF-assist beam is fired instead.

! Caution

- Speedlite AF-assist beam firing is disabled when the Speedlite's **[AF: AF-assist beam firing]** Custom Function is set to **[Disable]**.

Limit AF areas

You can limit the AF areas available to the areas that you normally use. Select available AF areas and press <  > to add a checkmark [✓]. Select [OK] to register the setting. For details on AF areas, see [AF Area](#).



⚠ Caution

- The [✓] mark cannot be cleared from all items at the same time.

📄 Note

- An asterisk to the right of [**AF: Limit AF areas**] indicates that the default setting has been modified.

AF area selection control

You can set how AF area selection methods are switched.

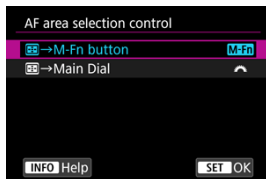

- **[M-Fn] ☞→M-Fn button**
Press the < ☞ > button, then the < M-Fn > button. Each press switches the AF area.
- **[☞] ☞→Main Dial**
Press the < ☞ > button, then turn the < ☞ > dial to switch the AF area.

Note

- When [☞→Main Dial] is set, use < ☞ > to move the AF point horizontally.

☞Multi-controller sensitivity in AF point selection

You can adjust Multi-controller sensitivity, which applies to AF point positioning.

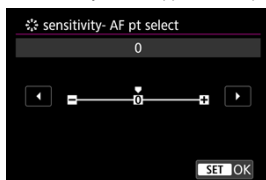

Orientation-linked AF points

You can set separate types of AF areas or positions of AF points for vertical and horizontal shooting.

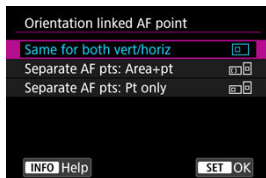

- **[□] Same for both vert/horiz**

The same AF points or Zone AF frames in the same AF areas are used in both vertical and horizontal shooting.

- **[□□] Separate AF pts: Area+pt**

Separate types of AF areas or separate positions of AF points or Zone AF frames can be set for each camera orientation ((1) Horizontal, (2) Vertical with the camera grip up, (3) Vertical with the camera grip down (☑)).

Useful when switching to other types of AF areas or positions of AF points or Zone AF frames automatically based on camera orientation.

AF areas and positions of AF points or Zone AF frames you assign to each of the three camera orientations are retained.

- **[□□] Separate AF pts: Pt only**

Separate positions of AF points or Zone AF frames can be set for each camera orientation ((1) Horizontal, (2) Vertical with the camera grip up, (3) Vertical with the camera grip down). Useful when switching to other positions of AF points or Zone AF frames automatically based on camera orientation.

Positions of AF points or Zone AF frames you assign to each of the three camera orientations are retained.

⚠ Caution

- The default setting of [**Same for both vert/horiz**] is restored if you select [**Basic settings**] in [**Reset camera**] (☑). Settings for orientations (1)–(3) are cleared, and the camera is set to use the center Zone AF frame in Flexible Zone AF 1.
- The setting may be cleared if you switch lenses.

Electronic full-time MF

Operation of manual focus adjustment using the electronic focusing ring when certain lenses are attached is customizable. Check the Canon website for compatible lenses (🔗).

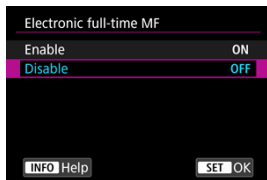

- **Disable**

Operation of manual focus adjustment corresponds to the [Lens electronic MF] setting.

- **Enable**

Manual focus adjustment is available whenever the camera is on.

Lens electronic MF

For lenses equipped with electronic manual focusing, you can specify how manual focus adjustment is used with One-Shot AF.

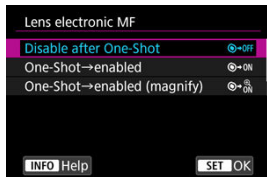

- **[📷→OFF] Disable after One-Shot**

After the AF operation, manual focusing adjustment is disabled.

- **[📷→ON] One-Shot→enabled**

You can manually adjust the focus after the AF operation if you keep holding down the shutter button halfway.

- **[ ON] One-Shot→enabled (magnify)**

You can manually adjust the focus after the AF operation if you keep holding down the shutter button halfway. You can magnify the area in focus and adjust the focus manually by turning the lens focusing ring.

- **[OFF] Disable in AF mode**

Manual focus adjustment is disabled when the lens's focus mode switch is set to < AF >.

 **Caution**

- With [**One-Shot→enabled (magnify)**], display may not be magnified even if you turn the lens focusing ring while pressing the shutter button halfway immediately after shooting. If so, you can magnify display by releasing the shutter button, waiting for [] display, then pressing the shutter button halfway as you turn the lens focusing ring.

 **Note**

- For details on your lens's manual focus specifications, refer to the Lens Instruction Manual.

Focusing ring rotation

You can reverse the direction that the focusing ring of RF lens is rotated to adjust settings.

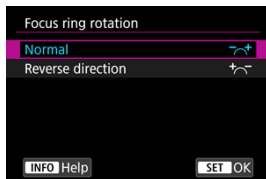

- [↶↷] Normal
- [↷↶] Reverse direction

Focusing ring sensitivity of RF lenses

You can set the sensitivity of the RF lens focusing ring.

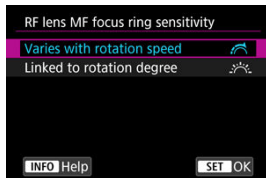

- [🔍↶↷] **Varies with rotation speed**
Focusing ring sensitivity varies depending on rotation speed.
- [🔍☀️] **Linked to rotation degree**
The focal position is adjusted based on the amount of rotation, regardless of the rotation speed.

Use as a focusing or control ring

Menu-based switching of lens focus/control ring functionality.

⚠ Caution

- Available when using lenses that have a combination focusing ring/control ring but have no switch to switch between these feature.

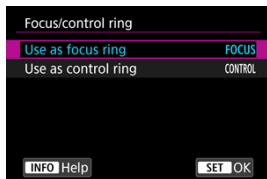

- **Use as focus ring**
The ring works as a focusing ring.
- **Use as control ring**
The ring works as a control ring.

📄 Note

- Switching is also possible from the Quick Control screen, when customized with [📷: Customize Quick Controls] (🔗).

Movie Servo AF speed

This function is available when **[AF: Movie Servo AF]** is set to **[Enable]**. You can set the AF speed and operating conditions for Movie Servo AF. The function is enabled when using a lens supporting slow focus transition during movie recording.*

● When active

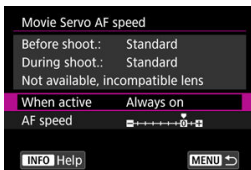

You can set **[Always on]** to have the AF speed take effect at all times for movie recording (before and during movie recording) or set **[During shooting]** to have the AF speed take effect only during movie recording.

● AF speed

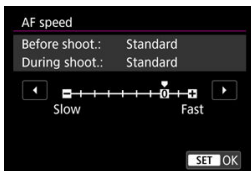

You can adjust the AF speed (focus transition speed) from the standard speed (0) to slow (one of seven levels) or fast (one of two levels) to obtain the desired effect for the movie creation.

* Lenses supporting slow focus transition during movie recording

USM and STM lenses released in and after 2009 are compatible. For details, refer to the Canon website ([🔗](#)).

⚠ Caution

- With certain lenses, even if you adjust the AF speed, the speed may not change.

Note

- Operation when inactive is equivalent to when [AF speed] is set to [Standard (0)].
- An asterisk "*" to the right of [AF: Movie Servo AF speed] indicates that the default setting has been modified.

Movie Servo AF tracking sensitivity

You can adjust the tracking sensitivity (to one of seven levels), which affects responsiveness if the subject strays from the AF point during Movie Servo AF, as when interfering objects move across AF points or when you pan.

This function is available when [AF: Movie Servo AF] is set to [Enable].

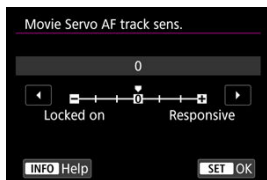

● Locked on: -3/-2/-1

With this setting, the camera is less likely to track a different subject if the subject strays from the AF point. The closer the setting is to the minus (-) symbol, the less the camera is inclined to track a different subject. It is effective when you want to prevent the AF points from rapidly tracking something that is not the intended subject during panning or when an obstacle cuts across the AF points.

● Responsive: +1/+2/+3

This makes the camera more responsive when tracking a subject that covers the AF point. The closer the setting is to the plus (+) symbol, the more responsive the camera is. It is effective when you want to keep tracking a moving subject as its distance from the camera changes or to rapidly focus on another subject.

Note

- Operation when inactive is equivalent to when set to [0].

Selecting the Drive Mode

Single and continuous drive modes are provided. You can select the drive mode suiting the scene or subject.

1. Press the <DRIVE•AF> button (ⓘ6).

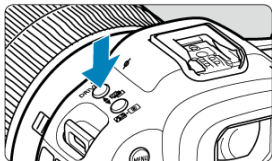

2. Select the drive mode.

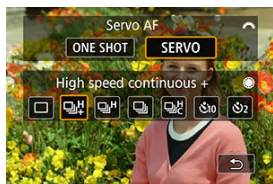

- Turn the <☀> dial to make a selection.

- **[☐] Single shooting**

When you hold down the shutter button completely, only one shot will be taken.

- **[☐+] High-speed continuous shooting +**

When you hold down the shutter button completely, you can shoot continuously as described below while you keep holding it down, based on the [📷: Shutter mode] setting.

- **[Electronic]:** max. approx. 30 shots/sec.
- **[Elec. 1st-curtain]:** max. approx. 12 shots/sec.
- **[Mechanical]:** max. approx. 12 shots/sec.

●  **High-speed continuous shooting**

When you hold down the shutter button completely, you can shoot continuously as described below while you keep holding it down, based on the  **Shutter mode** setting.

- **[Electronic]**: max. approx. 15 shots/sec.
- **[Elec. 1st-curtain]**: max. approx. 8.0 shots/sec.
- **[Mechanical]**: max. approx. 6.0 shots/sec.

●  **Low-speed continuous shooting**

When you hold down the shutter button completely, you can shoot continuously at **max. approx. 3.0 shots/sec.** while you keep holding it down.

●  **Custom high-speed continuous shooting**

You can capture up to 50 shots continuously at a maximum speed of 195 shots/sec.

- The electronic shutter is used in shooting.
- Details such as shutter speed, aperture value, and ISO speed are determined by conditions for the first shot.
- Shutter speeds slower than 1/30 sec. are not available.

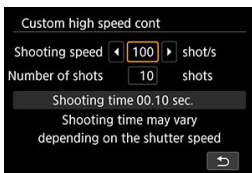

●  **Self-timer: 10 sec./remote control**

●  **Self-timer: 2 sec./remote control**



For self-timer shooting, see [Using the Self-Timer](#). For remote control shooting, see [Remote Control Shooting](#).

Caution

- Approx. 30 shots/sec. continuous shooting speed with **[Electronic]** set to  is available under the following conditions.

- Shutter speed: 1/125 sec. or faster
- Flicker reduction: None

Note that the continuous shooting speed may be less than 30 shots/sec. if any of the following occurs during continuous shooting.

- Switching to **[P]** or **[Tv]** shooting mode, or applying settings that cause the aperture value to change in **[Fv]** mode
 - Zooming is performed
 - Manual focusing is performed
 - Servo AF changes the position in focus
- Visit the Canon website for details on lenses supporting the maximum continuous shooting speed .
 - Continuous shooting speed with Servo AF may be slower depending on subject conditions or the lens used.
 - The continuous shooting speed will be lower when shooting under flickering light with **[Electronic]** is set. Also, the continuous shooting speed may be lower when **[Elec. 1st-curtain]** or **[Mechanical]** is set.
 - When internal memory becomes full during continuous shooting, the continuous shooting speed may drop off because shooting will be temporarily disabled .
 - Continuous shooting speed may be slower and image display in the viewfinder or on the screen may stop under some shooting conditions.

Using the Self-Timer

Use the self-timer when you want to be in the picture such as a commemorative photograph.

1. Press the <DRIVE•AF> button (ⓘ6).

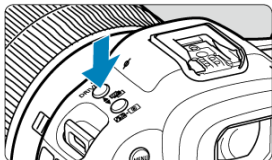

2. Select the self-timer.

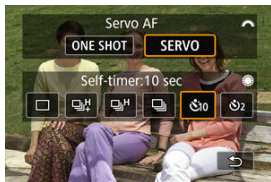

- Turn the <ⓘ6> dial to make a selection.
☑️: Shoot in 10 sec.
☑️: Shoot in 2 sec.

3. Take the picture.

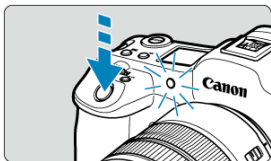

- Focus on the subject, then press the shutter button completely.
- To check operation, look at the self-timer lamp, listen for beeps, or watch the countdown in seconds on the screen.
- Self-timer lamp blinking accelerates and the camera beeps quickly approx. 2 sec. before the picture is taken.

Note

- [i] is used to start shooting without touching the camera (to avoid camera shake) when it is mounted on a tripod for shots such as still lifes or long exposures, for example.
- After taking self-timer shots, playing back the image (⏮) to check focus and exposure is recommended.
- When using the self-timer to shoot yourself, use focus lock (⏮) on an object at the same distance as where you will stand.
- To cancel the self-timer after it starts, either tap the screen or press < (SET) >.
- Auto power off time may be extended when the camera is set for remote control shooting.





Remote Control Shooting

 [Wireless Remote Control BR-E1](#)

 [Remote Switch RS-80N3 / Timer Remote Controller TC-80N3](#)

For remote control shooting, you can use an optional Wireless Remote Control BR-E1 (Bluetooth) or an optional Remote Switch RS-80N3 or Timer Remote Controller TC-80N3 (both wired).

Wireless Remote Control BR-E1

You can shoot remotely up to approx. 5 meters/16.4 feet from the camera. After pairing the camera and BR-E1 () , set the drive mode to [] or [] for still photo shooting (). For movie recording, set [: **Remote control**] to [**Enable**]. For operating instructions, refer to the BR-E1 instruction manual.

Note

- Auto power off time may be extended when the camera is set for remote control shooting.
- BR-E1 can also be used for movie recording.

Remote Switch RS-80N3 / Timer Remote Controller TC-80N3

Once connected to the camera, the switch enables you to shoot remotely over a wired connection.

For operating instructions, refer to the accessory instruction manual.

1. **Open the terminal cover.**
2. **Connect the plug to the remote control terminal.**

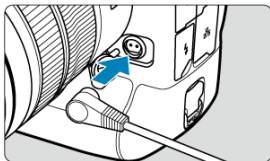

Playback

This chapter covers topics related to playback—playing back captured still photos and movies—and introduces menu settings on the playback [▶] tab.

⚠ Caution

- Normal display or selection on this camera may not be possible for images captured on other cameras, or images from this camera that have been edited or renamed on a computer.
- Images that cannot be used with playback functions may be displayed.

📄 Note

- You can set [👁: **Screen brightness**] (🔊) during playback by pressing the < ⚙ > button.

- [Tab Menus: Playback](#)
- [Image Playback](#)
- [Magnified Image Display](#)
- [Index Display \(Multiple-Image Display\)](#)
- [Voice Memo Recording and Playback](#)
- [Movie Playback](#)
- [Editing a Movie's First and Last Scenes](#)
- [4K Movie Frame Grab](#)
- [Playback on a TV Set](#)
- [Protecting Images](#)
- [Erasing Images](#)
- [Rotating Still Photos](#)
- [Changing Movie Orientation Information](#)
- [Rating Images](#)
- [Copying Images](#)
- [Print Ordering \(DPOF\)](#)
- [RAW Image Processing](#)
- [Cloud RAW Image Processing](#)
- [Resizing JPEG/HEIF Images](#)
- [Cropping JPEG/HEIF Images](#)
- [Converting HEIF to JPEG](#)
- [Slide Show](#)
- [Setting Image Search Conditions](#)

- [Browsing Images with the Main Dial](#)
- [Browsing Images with the Rate+Quick Control Dial 1](#)
- [Switching the Main Dial and Quick Control Dial 2](#)
- [Rate/Voice Memo Button Function](#)
- [Customizing Playback Information Display](#)
- [Displaying the Highlight Alert](#)
- [AF Point Display](#)
- [Playback Grid](#)
- [Movie Play Count](#)
- [HDMI HDR Output](#)

Tab Menus: Playback

● Playback 1

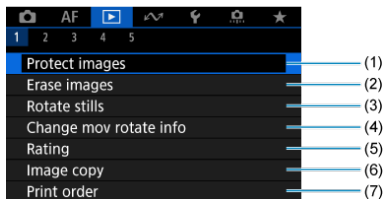

- (1) [Protect images](#)
- (2) [Erase images](#)
- (3) [Rotate stills](#)
- (4) [Change mov rotate info](#)
- (5) [Rating](#)
- (6) [Image copy](#)
- (7) [Print order](#)

● Playback 2

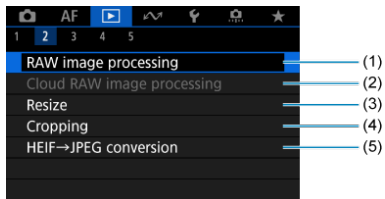

- (1) [RAW image processing](#)
- (2) [Cloud RAW image processing](#)
- (3) [Resize](#)
- (4) [Cropping](#)
- (5) [HEIF→JPEG conversion](#)

● Playback 3

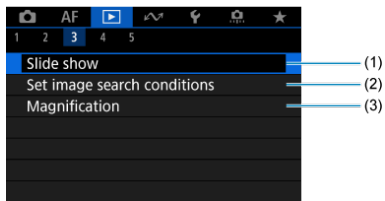

- (1) [Slide show](#)
- (2) [Set image search conditions](#)
- (3) [Magnification](#)

● Playback 4

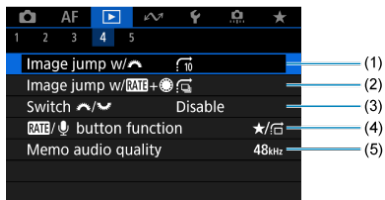

- (1) [Image jump w/ !\[\]\(448bd415caa8b52d2aeb4d58499267b2_img.jpg\)](#)
- (2) [Image jump w/ !\[\]\(23be4c52910c50d5908bb101588c4f4e_img.jpg\) !\[\]\(5dc449795a3a9c8d29c257423584cf78_img.jpg\)](#)
- (3) [Switch !\[\]\(4b7fb8a3e9c3712ee79f95e386b5ecd4_img.jpg\) !\[\]\(348b5f08c0a9aee916460ca5f8ad2999_img.jpg\)](#)
- (4) [!\[\]\(5b1a514e7f27fbd3f661e6a3500c4f68_img.jpg\) !\[\]\(2baf952763ad8c6fd37e6395b59f0aca_img.jpg\) button function](#)
- (5) [Memo audio quality](#)

● Playback 5

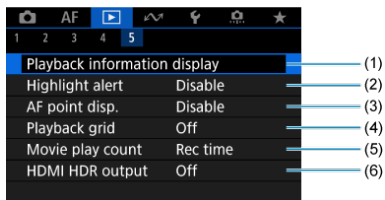

- (1) [Playback information display](#)
- (2) [Highlight alert](#)
- (3) [AF point disp.](#)
- (4) [Playback grid](#)
- (5) [Movie play count](#)
- (6) [HDMI HDR output](#)

Image Playback

[☑ Single-Image Display](#)

[☑ Shooting Information Display](#)

[☑ Touch Playback](#)

Single-Image Display

1. Switch to playback.

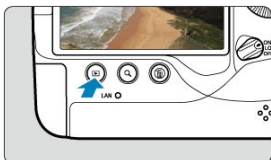

- Press the <  > button.
- The last image captured or played back is displayed.

2. Browse images.

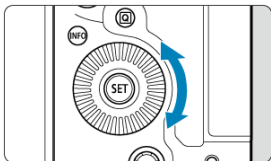



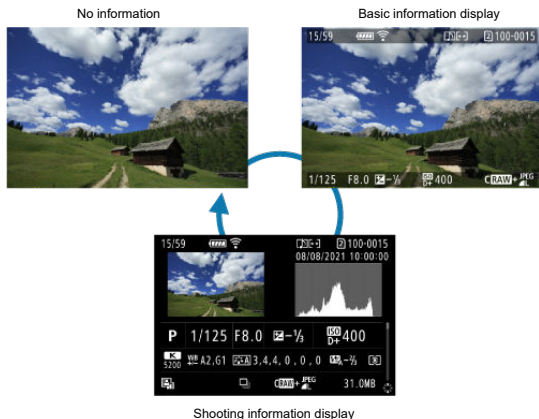



- To play back images starting with your most recent shot, turn the <  > dial counterclockwise. To play back images starting with the first captured image, turn the dial clockwise.
- Each time you press the < INFO > button, the display will change.



3. Exit image playback.

- Press the <  > button to exit image playback and return to shooting standby.

Note

- Lines indicating the image area are shown on RAW images captured with [:  **Cropping/aspect ratio**] set to [**1:1 (aspect ratio)**], [**4:3 (aspect ratio)**], or [**16:9 (aspect ratio)**] ().
- If the search conditions are set with [: **Set image search conditions**] (), only the filtered images will be displayed.
- When played back, images captured with [: **Add cropping information**] set to an option other than [**Disable**] () are displayed with lines indicating the image area.

Shooting Information Display

With the shooting information screen displayed (📄), you can press < ⌘ > up or down to view other information. You can also customize the information displayed, in [▶]: **Playback information display** (📄).

Touch Playback

The camera features a touch-screen panel that you can touch to control playback. Supported touch operations are like those used with smartphones and similar devices. First, press the <  > button to prepare for touch playback.

Browse images



Jump display



Index display

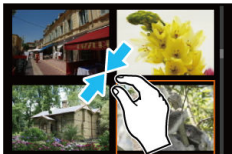

Magnified view



Note

- You can also magnify display by double-tapping with one finger.

Magnified Image Display

- ☑ [Setting the Initial Magnification Ratio](#)
- ☑ [Setting the Initial Magnification Position](#)
- ☑ [Magnification for Subsequent Images](#)

You can magnify display of your captured images.

1. Magnify the image.

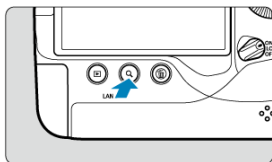

- Magnification is possible at these times: 1. During image playback (single-image display), 2. During image review after shooting, and 3. When the camera is ready to shoot.
- Press the < Q > button.
- The magnified view will appear. The position of the magnified area (1) is displayed in the lower right of the screen, along with [🔍 Q].
- To magnify images, turn the < 📏 > dial clockwise.
- To reduce magnification, turn the < 📏 > dial counterclockwise. Index display (🔍) can be accessed by turning the dial further (at the times of 1. and 3. only).

2. Scroll the image.

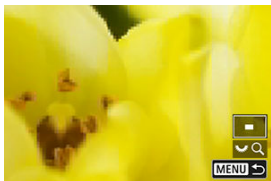
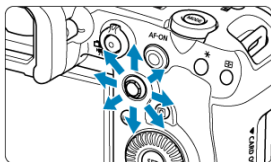

- Use < * > to scroll around the magnified image.
- With < * >, you can also move the magnified area itself.
- Press the < Q > or < MENU > button to exit magnified view.

Note

- To switch to other images while maintaining magnified view, turn the <  > dial (at the times of 1. and 3. only).
- Magnification is not available for movies.

Setting the Initial Magnification Ratio

You can set the initial magnification ratio.

1. Select [▶: Magnification].

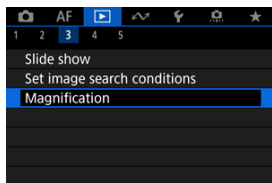

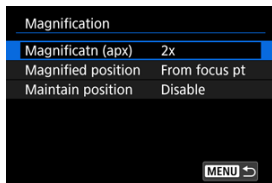

2. Select [Magnificatn (apx)].

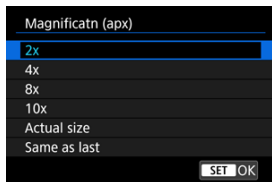

3. Select an option.



- **2x, 4x, 8x, 10x**
Magnified view starts at the selected magnification ratio.
- **Actual size**
The recorded image's pixels will be displayed at approx. 100%.
- **Same as last**
Magnified view resumes from the same ratio as the last time you exited magnified view with the <  > or <  > button.

Setting the Initial Magnification Position

You can set the initial magnification position.

1. Select [: Magnification].

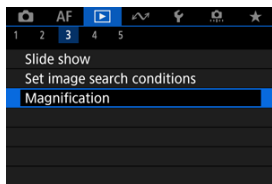

2. Select [Magnified position].

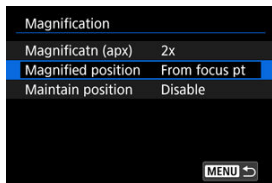

3. Select an option.

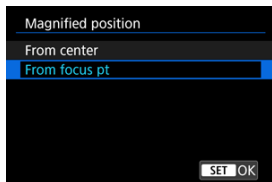

- **From center**
Magnified view starts from the center of the screen.
- **From focus pt**
Magnified view starts from the AF point in focus. If the photo is taken with manual focus, the magnified view starts from the center of the screen.

Magnification for Subsequent Images

You can specify whether to maintain the same position for magnified view or use to the position set in **[Magnified position]** when displaying subsequent images.

1. Select **[: Magnification]**.

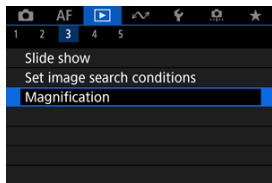

2. Select **[Maintain position]**.

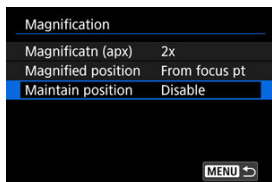

3. Select an option.

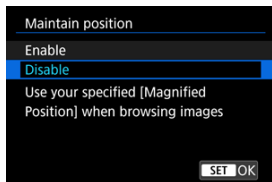

- **Enable**
The current magnified position is maintained when displaying subsequent images in magnified view.
- **Disable**
The position set in [**Magnified position**] is used when displaying subsequent images in magnified view.

Index Display (Multiple-Image Display)

1. Press the <Q> button.

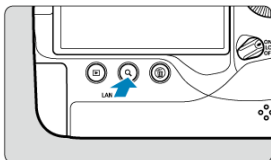

- During image playback, press the <Q> button.
- [👁️Q] will be displayed in the lower right of the screen.

2. Switch to the index display.

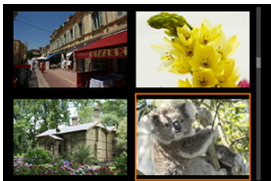

- Turn the <👁️> dial counterclockwise.
- The 4-image index display will appear. The selected image is highlighted with an orange frame.
- Turning the <👁️> dial further counterclockwise will switch the display from 9 to 36 to 100 images. Turning the dial clockwise cycles through 100, 36, 9, 4, and single-image display.

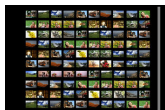
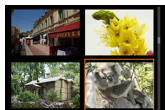

3. Browse images.



- Use < * > or the < ⌚ > dial to move the orange frame for image selection.
- Press < SET > in the index display to display the selected image in the single-image display.

Voice Memo Recording and Playback

 [Recording Voice Memos](#)

 [Memo Audio Quality](#)

 [Playing Voice Memos](#)

You can add (record) voice memos to your shots. Voice memos are recorded as WAV audio files with the same file number as the image. They can be played back by the camera or a computer.

Recording Voice Memos

1. Switch to playback.
2. Select an image to add a voice memo to.
 - Turn the <  > dial to select an image to add a voice memo to.

3. Record a voice memo.

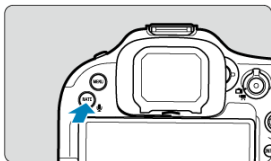

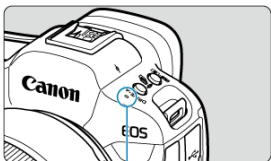

- Hold down the < **RATE** /  > button for approx. 2 sec.

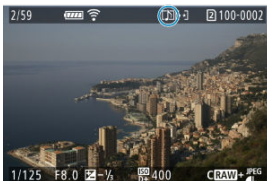

(1)

- Keep holding down the button after [**Recording memo...**] appears, and speak into the microphone (1). Each recording can be up to approx. 30 sec.
- To end the voice memo, release the button.



- A [] icon is displayed at the top of the screen.

 **Caution**

- Voice memos cannot be added to movies.
- Voice memos cannot be recorded with an external microphone.
- Voice memos cannot be added to images during transfer to an FTP server.

 **Note**

- Audio quality of voice memo recording can be changed in []: **Memo audio quality**].
- To record voice memos longer than 30 sec., repeat step 3.
- You can record a single voice memo during image review (immediately after shooting) by following step 3.

Memo Audio Quality

You can set the audio quality for recording voice memos.

1. Select [▶: Memo audio quality].

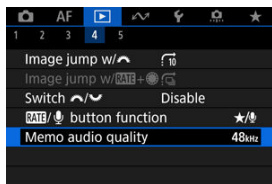

2. Select an option.

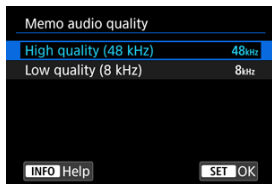

- **48 kHz: High quality (48 kHz)**
Enables voice memo recording at the same level of audio quality as movies.
- **8 kHz: Low quality (8 kHz)**
Enables smaller voice memo file sizes than with [High quality (48 kHz)].

⚠ Caution

- Additional voice memo recording for images with existing voice memos is performed at the same level of audio quality as the first recording, regardless of this setting.

1. Select [▶️]: [RATE]/🎤 button function].

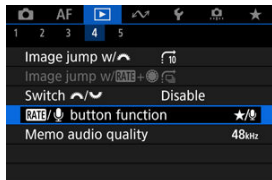

2. Select [▶️]/🎤].

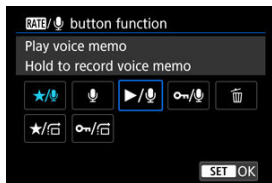

3. Select an image for voice memo playback.

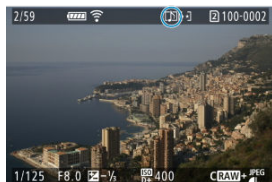

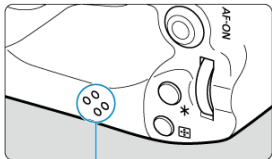
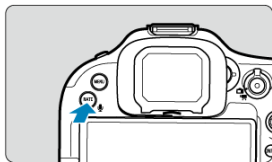

- Press the <▶️> button to switch to image playback.
- Turn the <📷> dial to select an image labeled with a [🎤] icon at the top of the screen.

4. Play back the voice memo.



(1)

- Press the < **RATE** /  > button to play back the voice memo through the speaker (1).
- You can adjust the sound volume by turning the <  > dial.
- Press the < **RATE** /  > button to stop playback.

Note

- Multiple voice memos added to an image are played back consecutively.
- Erasing images () also erases any voice memos added to the images.

Movie Playback

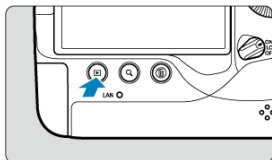

1. Switch to playback.





- Press the <  > button.

2. Select a movie.

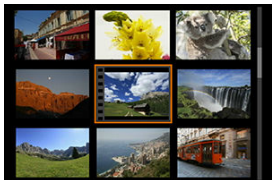

- Turn the <  > dial to select a movie to play.
- In single-image display, the [**SET** ] icon displayed in the upper left of the screen indicates a movie.





- In index display, perforations at the left edge of a thumbnail indicate a movie. Movies cannot be played back from index display, so press <  > to switch to single-image display.

3. In the single-image display, press <  >.

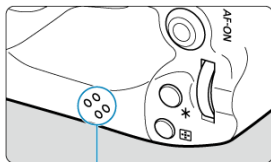
4. Press <  > to play back the movie.



- The movie will start playing back. Sound is played through the speaker (1).
- You can pause playback and display the movie playback panel by pressing <  >. Press it again to resume the playback.
- Turn the <  > dial to adjust the volume (even during playback).

Movie playback panel

Item	Playback Operations
Playback	Pressing < > toggles between playback and stop.
Slow motion	Adjust the slow motion speed by turning the < > dial. The slow motion speed is indicated in the upper right of the screen.
Skip backward	Skips backward approx. 1 sec. each time you press < >. Holding < > down will rewind the movie.
Previous frame	Displays the previous frame each time you press < >. Holding < > down will rewind the movie.
Next frame	Plays the movie frame-by-frame each time you press < >. Holding < > down will fast forward the movie.
Skip forward	Skips forward approx. 1 sec. each time you press < >. Holding < > down will fast forward the movie.
Edit	Displays the editing screen ().
Frame Grab	Available when you play 4K movies. Enables you to extract the current frame and save it as a JPEG or HEIF still image ().
	Playback position
hh:mm:ss	Playback time (hours:minutes:seconds, when [Movie play count] is set to [Rec time])
hh:mm:ss.ff (DF) hh:mm:ss:ff (NDF)	Time code (hours:minutes:seconds:frames, when [Movie play count] is set to [Time code])
Volume	Turn the < > dial to adjust the volume of the speaker () or headphones.
	Press the < MENU > button to return to single-image display.

Caution

- Adjust the volume using television controls when the camera is connected to a television for movie playback (), because volume cannot be adjusted by turning the < > dial.
- Movie playback may stop if the card's read speed is too slow or movie files have corrupted frames.

Editing a Movie's First and Last Scenes

You can edit out the first and last scenes of a movie in approx. 1-sec. increments.

1. In single-image display, press $\langle \text{SET} \rangle$.



2. On the movie playback panel, select $\langle \text{SET} \rangle$.



3. Specify the part to be edited out.



- Select either [⏏] (Cut beginning) or [⏏] (Cut end).

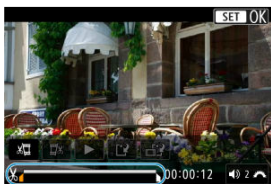

- Press < ⏏ > left or right to go back or forward one frame. Keep pressing the Multi-controller to fast rewind or fast forward frames. Each turn of the < ⏏ > dial goes back or forward one frame.
- After deciding which part to edit out, press < SET >. The portion indicated by a line at the bottom of the screen will remain.

4. Check the edited movie.

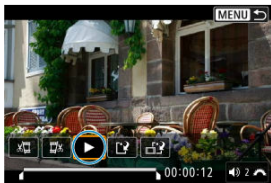

- Select [▶] to play back the edited movie.
- To change the edited part, go back to step 3.
- To cancel the editing, press the < MENU > button.

5. Save.

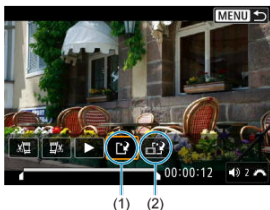

- Select **[L]** (1).
- The save screen will appear.
- To save it as a new file, select **[New file]**, or to save it and overwrite the original movie file, select **[Overwrite]**.
Select **[L]** (2) to save a compressed version of the file. 4K movies are converted to Full HD movies before compression.
- On the confirmation screen, select **[OK]** to save the edited movie and return to the movie playback screen.

⚠ Caution



- Because editing is performed in approx. 1 sec. increments (at the position indicated by **[X]** at the bottom of the screen), the actual position where movies are trimmed may differ from your specified position.
- Movies shot with another camera cannot be edited with this camera.
- You cannot edit a movie when the camera is connected to a computer.
- Compress and save is not available for the following movies.
 - Movies recorded with **[📷: HDR shooting [HDR PQ]]** set to **[Enable]**
 - Movies recorded with **[📷: Canon Log settings]** set to **[On (C.LOG3)]**
 - Movies recorded in **[FHD 29.97P [IPB]]** (NTSC), **[FHD 25.00P [IPB]]** (PAL), **[FHD 23.98P [IPB]]** (NTSC), or **4K-D** sizes
- Movies may not be compressed when the remaining batter capacity is low. Use of a fully charged battery or a household power outlet accessory (sold separately) is recommended.
- For extensive movie editing, consider using an optional household power outlet accessory.

4K Movie Frame Grab

From 4K movies, you can select individual frames to save as JPEG or HEIF still images. This function is called "Frame Grab."

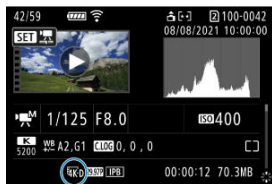
1. Select a 4K movie.



- Turn the <  > dial to select a 4K quality movie.
- On the shooting information screen () , 4K movies are labeled with [4K-D] and [4K-U] icons.
- In index display, press <  > to switch to single-image display.

2. In the single-image display, press < >.

- The movie playback panel will appear.

3. Select a frame to grab.



- Use the movie playback panel to select the frame to grab as a still image.
- For movie playback panel instructions, see [Movie playback panel](#).

4. Select [Still].



5. Save.



- Select [OK] to save the current frame as a JPEG still image. Frame grabs from HDR movie files are saved as HEIF images.
- Check the destination folder and image file number.

6. Select the image to display.

- Select [View original movie] or [View extracted still image].

! Caution

- Frame grabbing is not possible from the following 4K movies.
 - RAW movies
 - Movies recorded with [📷: Canon Log settings] set to [On (C.LOG3)]
 - Movies recorded with other cameras
- Frame grabbing is not possible while the camera is connected to a computer.

Playback on a TV Set

By connecting the camera to a television with a commercially available HDMI cable, you can play back the captured still photos and movies on the television.

If the image does not appear on the TV screen, confirm that [**⚙**: Video system] is correctly set to [For NTSC] or [For PAL] (depending on the video system of your television).

1. Connect the HDMI cable to the camera.

- Use the cable protector (🔒) and insert the HDMI cable in the camera's < **HDMI OUT** > terminal.

2. Connect the HDMI cable to the television.

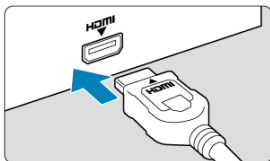

- Connect the HDMI cable to the television's HDMI IN port.

3. Turn on the television and switch the television's video input to select the connected port.

4. Set the camera's power switch to < ON >.

5. Press the < ▶ > button.

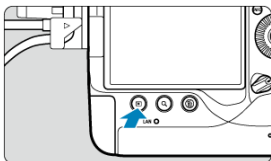

- Images are now displayed on the television, with nothing displayed on the camera screen.
- The images will automatically be displayed at the optimum resolution matching the connected television.

Caution

- Adjust movie sound volume with the television. The sound volume cannot be adjusted with the camera.
- Before connecting or disconnecting the cable between the camera and television, turn off the camera and television.
- Depending on the television, part of the image displayed may be cut off.
- Do not connect any other device's output to the camera's < **HDMI OUT** > terminal. Doing so may cause a malfunction.
- Certain televisions may not display the images due to incompatibility.
- It may take some time before images are displayed. To avoid delay, set [🔊: **HDMI resolution**] to [1080p] (🔊).
- Touch-screen operations are not supported while the camera is connected to a television.

Protecting Images

[✔ Protecting Individual Images via the Menu](#)

[✔ Specifying the Range of Images to Protect](#)

[✔ Protecting All Images in a Folder or on a Card](#)

You can protect important images from being accidentally erased.

! Caution

- If you format the card (✔), the protected images will also be erased.

📄 Note

- Once an image is protected, it cannot be erased by the camera's erase function. To erase a protected image, you must first cancel the protection.
- If you erase all the images (✔), only the protected images will remain. This is convenient when you want to erase all unneeded images at once.
- Voice memos can be added to protected images. For images with existing voice memos, additional voice memo recording is also possible.

Protecting Individual Images via the Menu

1. Select [▶]: Protect images].

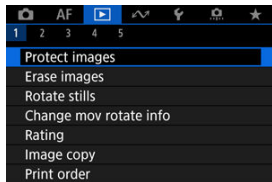

2. Select [Select images].

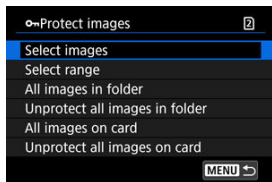





3. Select the image to protect.

- Turn the <  > dial to select an image to protect.

4. Protect the image.



- Press <  > to protect the selected image, after which it will be labeled with a  icon (1) at the top of the screen.
- To cancel protection and clear the  icon, press <  > again.
- To protect another image, repeat steps 3 and 4.

Note

- During playback, you can protect images by pressing the < **RATE** /  > button ().

Specifying the Range of Images to Protect

While looking at the images in the index display, you can specify the first and last images for a range to protect all the specified images at once.

1. Select [Select range].

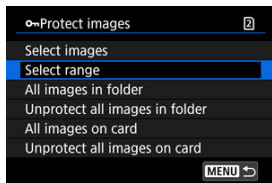

- Select [Select range] in []: Protect images].

2. Specify the range of images.



- Select the first image (start point).
- Next, select the last image (end point). The images in the specified range will be protected and the [] icon will appear.
- To select another image to protect, repeat step 2.

Protecting All Images in a Folder or on a Card

You can protect all the images in a folder or on a card at once.

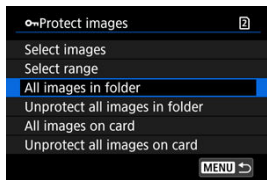

- When you select **[All images in folder]** or **[All images on card]** in **[]: Protect images**, all the images in the folder or on the card will be protected.
- To cancel protection, select **[Unprotect all images in folder]** or **[Unprotect all images on card]**.
- If the search conditions are set with **[]: Set image search conditions** (🔍), the display will change to **[All found images]** and **[Unprotect all found]**.

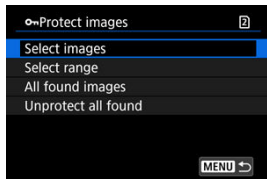

- If you select **[All found images]**, all the images filtered by the search conditions will be protected.
- If you select **[Unprotect all found]**, the protection of all the filtered images will be canceled.

Note

- Protecting or unprotecting images by selecting **[All images on card]** or **[Unprotect all images on card]** applies to the card selected in **[]: Record func+card/folder sel.** (in either **[📷 Record/play]/[📷 Record/play]** or **[📷 Play]/[📷 Play]**).

Erasing Images

- [Erasing Images Individually](#)
- [Selecting \(\[√\]\) Multiple Images to Erase Together](#)
- [Specifying the Range of Images to Erase](#)
- [Erasing All Images in a Folder or on a Card](#)

You can either select and erase unnecessary images individually or erase them in one batch. Protected images (🔒) will not be erased.

⚠ Caution

- **Once an image is erased, it cannot be recovered. Make sure you no longer need the image before erasing it. To prevent important images from being erased accidentally, protect them.**

Erasing Images Individually

1. Press the <▶> button.
2. Select the image to be erased.
 - Turn the <⦿> dial to select the image to erase.
3. Press the <🗑> button.

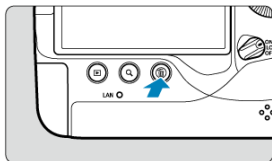

4. Erase the images.

JPEG/HEIF/RAW images or movies

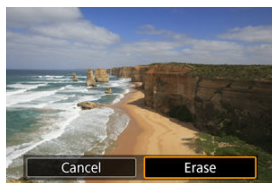



- Select [**Erase**].

RAW+JPEG/RAW+HEIF images



- Select an option.
- For images with voice memos, you can also erase just the voice memo during image playback by selecting [**Erase voice memo**].
- Series of images captured in [M], [M], or [M] drive mode are erased when you select [**Erase scene including image**] during playback.

Note

- During playback, you can erase images by pressing the < **RATE** /  > button ().

Selecting ([✓]) Multiple Images to Erase Together

By adding checkmarks to the images to be erased, you can erase all those images at once.

1. Select [▶]: Erase images].

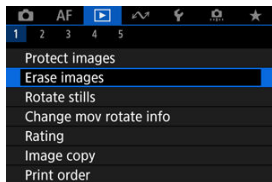

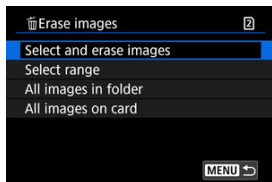

2. Select [Select and erase images].



3. Select an image.



- Turn the <  > dial to select an image to erase, then press <  >.
- To select another image to be erased, repeat step 3.

4. Erase the images.

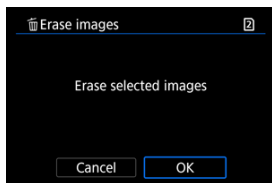

- Press the < [Q] > button, then press [OK].

Specifying the Range of Images to Erase

While looking at the images in the index display, you can specify the first and last images for a range to erase all the specified images at once.

1. Select [Select range].

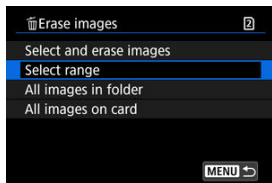

- Select [Select range] in [▶]: Erase images].

2. Specify the range of images.



- Select the first image (start point).
- Next, select the last image (end point). A checkmark [✓] will be appended to all the images within the range between first and last images.
- To select another image to be erased, repeat step 2.

3. Press the <Q> button.

4. Erase the images.

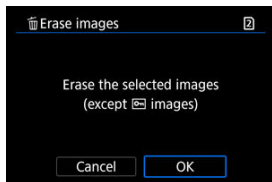

- Select **[OK]**.

Erasing All Images in a Folder or on a Card

You can erase all the images in a folder or on a card at once.

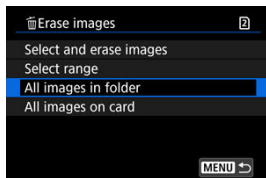

- When you select **[All images in folder]** or **[All images on card]** in **[▶]: Erase images**, all the images in the folder or on the card will be erased.
- If the search conditions are set with **[▶]: Set image search conditions** (🔍), the display will change to **[All found images]**.

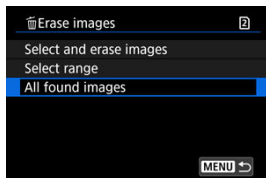

- If you select **[All found images]**, all the images filtered by the search conditions will be erased.

Note

- To erase all the images including protected images, format the card (🔗).
- Erasing images by selecting **[All images on card]** applies to the card selected in **[👉: Record func+card/folder sel.]** (in either **[📷 Record/play]/[📷 Record/play]** or **[📷 Play]/[📷 Play]**).

Rotating Still Photos

You can use this feature to rotate the displayed image to the desired orientation.

1. Select []: Rotate stills].

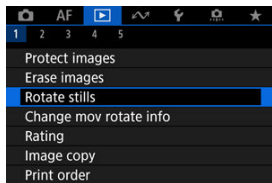

2. Select an image to rotate.

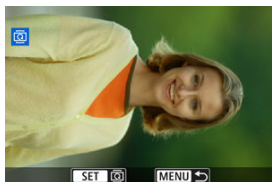

- Turn the < > dial to select the image.



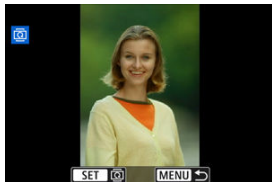

3. Rotate the image.



- Each time you press < SET >, the image will rotate clockwise as follows: 90°→270°→0°.
- To rotate another image, repeat steps 2 and 3.



Note

- If you set [**⚙**: **Auto rotate**] to [**On**] () before taking pictures, you need not rotate the image with this function.
- If the rotated image is not displayed in the rotated orientation during image playback, set [**⚙**: **Auto rotate**] to [**On**].
- Movies cannot be rotated.

Changing Movie Orientation Information

You can manually edit movie playback orientation information (which determines which side is up).

1. Select []: Change mov rotate info].

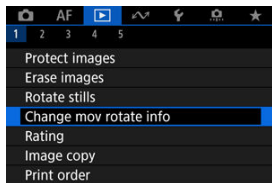

2. Select a movie.

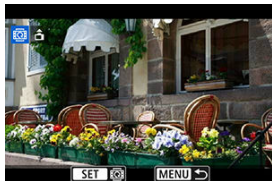

- Turn the <  > dial to select a movie with orientation information to change.

3. Change the orientation information.

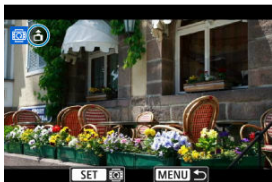

- As you watch the camera and ▲ icon in the upper left of the screen, press <SET> to specify which side is up. Each press of <SET> edits the movie rotation information as follows: [📷] → [📷] → [📷].

⚠ Caution

- Movies are played horizontally on the camera and via HDMI video output, regardless of the [📷: Add 🗑 rotate info] setting (🔒).
- Movie orientation information of movies recorded with other cameras cannot be edited with this camera.





Rating Images

[Rating Individual Images With the < RATE / !\[\]\(c8d96c8885d3000a912c2582004aed63_img.jpg\) > Button](#)

[Rating Individual Images via the Menu](#)

[Rating by Specifying the Range](#)



[Rating All Images in a Folder or on a Card](#)

You can rate images on a scale of 1–5 ( /  /  /  / ). This function is called rating.

* Rating images can help you organize them.

Rating Individual Images With the < RATE / > Button

1. Select the image to be rated.



- Press the <  > button to switch to image playback.
- Turn the <  > dial to select the image to be rated.

2. Rate the image.



- Press the < **RATE** /  > button to rate the image.
- To rate another image, repeat steps 1 and 2.

 **Note**

- During playback, you can rate images by pressing the < **RATE** /  > button ().

Rating Individual Images via the Menu

1. Select []: Rating].

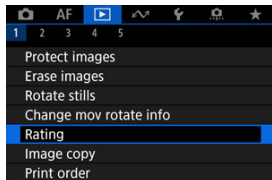

2. Select [Select images].

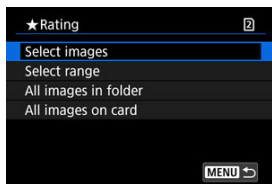





3. Select the image to be rated.

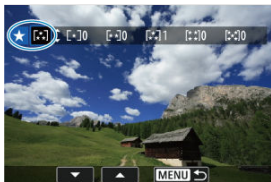

- Turn the <  > dial to select the image to be rated.

4. Rate the image.



- Press <  >, and a blue highlight frame will appear as shown in the screen shown above.
- Turn the <  > dial to select a rating mark, then press <  >.
- When you append a rating mark to the image, the number beside the set rating will increase by one.
- To rate another image, repeat steps 3 and 4.

Rating by Specifying the Range

While looking at the images in the index display, you can specify the first and last images for a range to rate all the specified images at once.

1. Select [Select range].

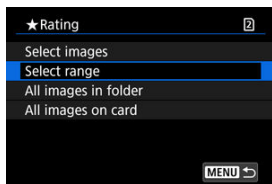

- Select [Select range] in []: Rating.

2. Specify the range of images.



- Select the first image (start point).
- Next, select the last image (end point). A checkmark [✓] will be appended to all the images within the range between first and last images.
- To select other images, repeat step 2.

3. Press the < [Q] > button.

4. Rate the images.



- Turn the <  > dial to select a rating mark, then select [OK]. All the images in the specified range will be rated (same rating) at once.

Rating All Images in a Folder or on a Card

You can rate all the images in a folder or on a card at once.

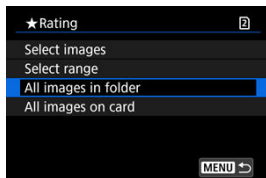

- Under **[▶]: Rating**, when you select **[All images in folder]** or **[All images on card]**, all the images in the folder or on the card will be rated.



- Turn the **< [Sun] >** dial to select a rating, then select **[OK]**.
- When you are not rating images or canceling the rating, select **[OFF]**.
- If the search conditions are set with **[▶]: Set image search conditions** (🔍), the display will change to **[All found images]**.

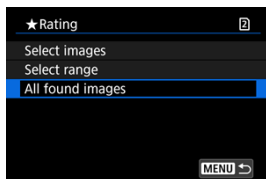

- If you select **[All found images]**, all the images filtered by the search conditions will be rated as specified.



Note

- Values next to ratings are displayed as [###] if more than 1,000 images have that rating.
- With [▶]: **Set image search conditions**] and [▶]: **Image jump w/🌅**], you can display only the images given a specific rating.

Copying Images

 [Copying Individual Images](#)

 [Copying a Range of Images](#)

 [Copying All Images in a Folder or on a Card](#)

You can copy the images on one card to the other card to save duplicates.
All images in a folder or on a card can also be copied at the same time.





Caution

- For extensive copying, consider using a household power outlet accessory (sold separately).
- If the target folder or card already has an image with the same file number, [**Skip image and continue**], [**Replace existing image**], and [**Cancel copy**] are displayed. Select a copying method, then press <  >.
 - [**Skip image and continue**]: Any images with the same file number are skipped and not copied.
 - [**Replace existing image**]: Any images with the same file number (including protected images) are overwritten.

Overwriting images that had print order information () will require you to set the print order information again.

- Print order and image transfer information is not included in copies of images.
- Shooting is not possible during the copying process. Select [**Cancel**] before shooting.

Note

- Images are copied from the card selected in [: **Record func+card/folder sel.**] (in either [ **Record/play**]/[ **Record/play**] or [ **Play**]/[ **Play**]).
- Copies of images have the same file name as the original image.
- With [**Sel. Image**], images in multiple folders cannot be copied at the same time. Select images to copy from one folder at a time.
- Any voice memos added to images are also copied.

Copying Individual Images

1. Select []: Image copy].

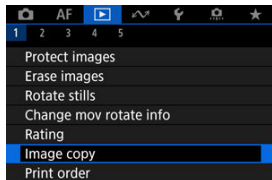

2. Select [Sel.Image].

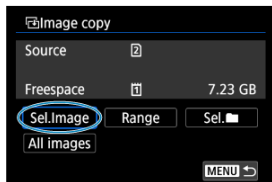

- Check the source and target card numbers and the free space on the target card.
- Select [Sel.Image], then press < (SET) >.

3. Select the folder.

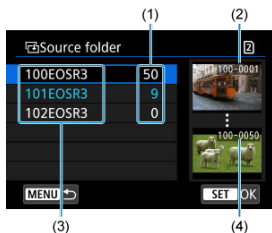

- (1) Number of images in folder
- (2) Lowest file number
- (3) Folder name
- (4) Highest file number

- Select the source folder, then press $\langle \text{SET} \rangle$.
- When selecting the folder, refer to the images displayed at right of the screen.

4. Select an image to copy.

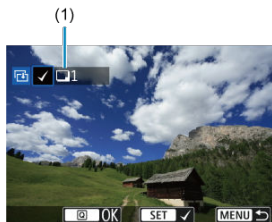

- (1) Total images selected

- Turn the $\langle \text{DIAL} \rangle$ dial to select an image to copy, then press $\langle \text{SET} \rangle$.
- To select another image to copy, repeat step 4.

5. Press the <Q> button.

6. Select [OK].

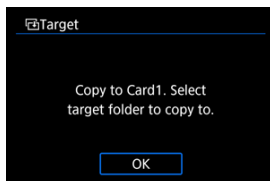

- Check the target card, then select [OK].

7. Select the target folder.

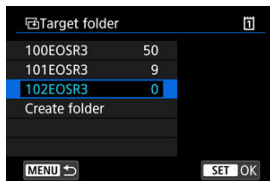

- Select the folder to copy the image to, then press <SET>.
- To create a new folder, select [Create folder].

8. Select [OK].

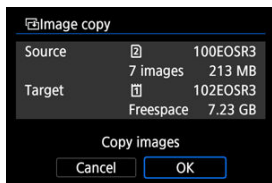

- Check the information about the source and target card, then select [OK].

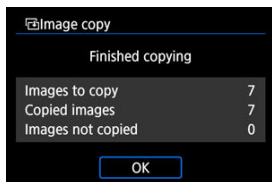

- Results are displayed after copying is finished. Select [OK] to return to the screen in step 2.

Copying a Range of Images

You can copy all specified images at once by selecting the first and last images in a range as you look at images in the index display.

1. Select [Range].

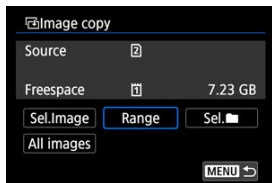

2. Select the folder.

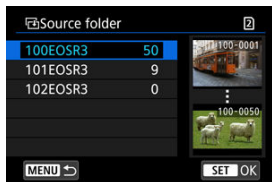

- Select the source folder, then press < (SET) >.
- When selecting the folder, refer to the images displayed at right of the screen.

3. Specify the range of images.



- Select the first image (start point).
- Next, select the last image (end point). A checkmark [✓] will be appended to all the images within the range between first and last images.
- To select another image to copy, repeat step 3.

4. Press the <Q> button.

- Images in the specified range are now copied.

Copying All Images in a Folder or on a Card

You can copy all the images in a folder or on a card at once.

Selecting [Sel. : Image copy] copies all the images it contains.

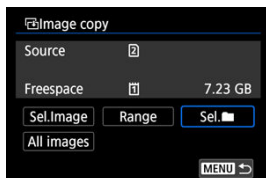

Print Ordering (DPOF)

 [Print Options](#)

 [Selecting Images for Printing](#)

DPOF (Digital Print Order Format) enables you to print images recorded on the card according to your printing instructions such as the image selection, quantity to print, etc. You can print multiple images in one batch or create a print order for a photofinisher.

You can set the print settings such as print type, date imprinting, file number imprinting, etc. The print settings will be applied to all the images specified for printing. (They cannot be set individually for each image.)

Print Options

1. Select [: Print order].

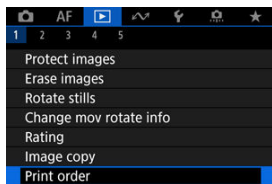

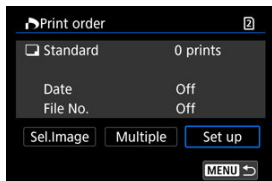

2. Select [Set up].



3. Set the options as desired.

- Set **[Print type]**, **[Date]**, and **[File No.]** options.

Print type	 Standard	Prints one image on one sheet.
	 Index	Multiple thumbnail images are printed on one sheet.
	 Both	Prints both the standard and index prints.
Date	On	[On] imprints the recorded date of the captured image.
	Off	
File No.	On	[On] imprints the file number.
	Off	

4. Exit the setting.

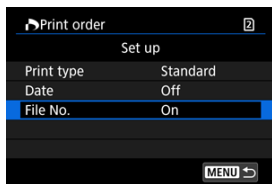

- Press the < **MENU** > button.
- Next, select **[Sel.Image]** or **[Multiple]** to specify the images to be printed.

 **Caution**

- If you print an image with a large image size using the **[Index]** or **[Both]** setting (📄), the index print may not be printed with certain printers. In this case, resize the image (📏), then print the index print.
- Even if **[Date]** and **[File No.]** are set to **[On]**, the date or file number may not be imprinted, depending on the print type setting and printer.
- With **[Index]** prints, the **[Date]** and **[File No.]** cannot both be set to **[On]** at the same time.
- When printing with DPOF, use the card for which print order specifications are set. You cannot print in the specified print order if you extract just the images from the card for printing.
- Certain DPOF-compliant printers and photofinishers may not be able to print the images as you specified. When using a printer, refer to the printer's instruction manual. When requesting service from a photofinisher, ask in advance.
- Do not use this camera to configure print settings for images with DPOF settings set up on another camera. All the print orders may be overwritten inadvertently. Also, the print order may not be possible, depending on the image type.

Selecting Images for Printing

Selecting images

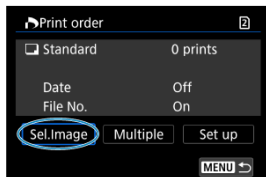

Select and specify the images individually.

Press the < MENU > button to save the print order to the card.

● Standard/Both



Press < SET > to print a copy of the displayed image. By turning the < dial >, you can set a print quantity of up to 99 copies.

● Index

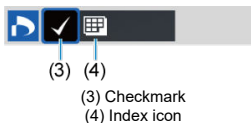

Press < SET > to add a checkmark [✓] to the box. The image will be included in the index print.

Selecting multiple images

- **Select range**

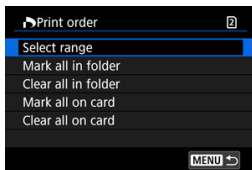

Select **[Select range]** in **[Multiple]**. Selecting the first and last images of the range marks all the images in the range with a checkmark [✓], and one copy of each image will be specified for printing.

- **All images in a folder**

Select **[Mark all in folder]** and select the folder. A print order for one copy of all the images in the folder will be specified.

If you select **[Clear all in folder]** and select the folder, the print order for all the images in the folder will be canceled.

- **All images on a card**

If you select **[Mark all on card]**, one copy of all the images on the card will be specified for printing.

If you select **[Clear all on card]**, the print order will be cleared for all the images on the card.

If the search conditions are set with **[▶]: Set image search conditions** (🔍) and you select **[Multiple]**, the display will change to **[Mark all found images]** and **[Clear all found images]**.

- **All found images**

If you select **[Mark all found images]**, one copy of all the images filtered by the search conditions will be specified for printing.

If you select **[Clear all found images]**, all the print order of the filtered images will be cleared.

⚠ Caution

- RAW images or movies cannot be specified for printing. Note that RAW images or movies will not be specified for printing even if you specify all images with **[Multiple]**.

RAW Image Processing

- [Magnified View](#)
- [Processing Images with Specified Aspect Ratios](#)
- [RAW Image Processing Options](#)

You can process **RAW** or **CRAW** images with the camera to create JPEG or HEIF images. RAW images are not affected, so different conditions can be applied to create JPEG or HEIF images.

You can also use Digital Photo Professional (EOS software) to process RAW images.

Caution

- Processing into HEIF is not available for **RAW** or **CRAW** images captured with expanded ISO speed (L or H).

1. Select []: RAW image processing].

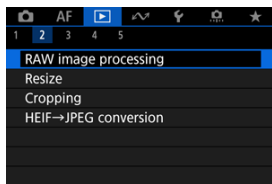

2. Select an option, then select images.

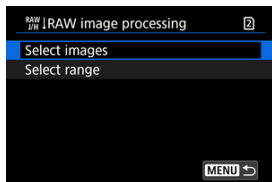

- You can select multiple images to process at once.

Select images

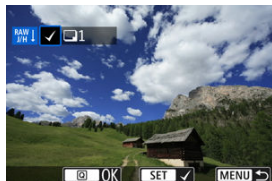

- Turn the \odot dial to select images to process, then press $\langle \text{SET} \rangle$.
- Press the $\langle \text{Q} \rangle$ button.

Select range

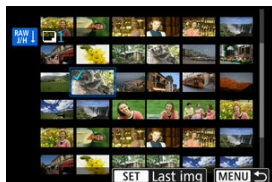

- Select the first image (start point).
- Next, select the last image (end point). A checkmark [✓] will be appended to all the images within the range between first and last images.
- To process other images, repeat this step.
- Press the $\langle \text{Q} \rangle$ button.

3. Set the desired processing conditions.

Use shot settings

- Images are processed using image settings at the time of capture.
- Images captured with [CAMERA: HDR shooting **HDR PQ**] set to [Enable] are processed to create HEIFs, and images captured with this function set to [Disable] are processed to create JPEGs.

Set up processing → JPEG/Set up processing → HEIF



- Use < * > to select an item.
- Turn the < [Sun icon] > or < [Dial icon] > dial to switch the setting.
- Press < [SET] > to access the function setting screen.
- To return to the image settings at the time of shooting, press the < [Trash icon] > button.

Comparison screen

- You can switch between the [After change] and [Shot settings] screens by pressing the < [INFO] > button and turning the < [Dial icon] > dial.
- Items in orange on the [After change] screen have been modified since the time of capture.
- Press the < [MENU] > button to return to the processing conditions screen.

4. Save.

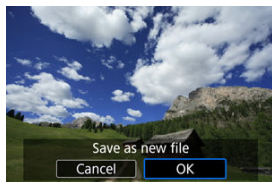

- When using [**Set up processing**→**JPEG**] or [**Set up processing**→**HEIF**], select [**⌘S**] (Save).
- Read the message and select [**OK**].
- To process other images, select [**Yes**] and repeat steps 2–4.

5. Select the image to display.



- Select [**Original image**] or [**Processed img.**].
- Your selected image is displayed.



Magnified View

You can magnify images displayed for **[Set up processing→JPEG]** or **[Set up processing→HEIF]** by pressing the <Q> button. The magnification ratio varies depending on the **[Image quality]** setting. With <⌘>, you can scroll around the magnified image. To cancel the magnified view, press the <Q> button again.

Caution

- Results of processing with **[Digital Lens Optimizer]** set to **[High]** are only applied in magnified view. Results are not applied in normal display.

Processing Images with Specified Aspect Ratios



JPEG or HEIF images at the specified aspect ratio are created when you process RAW images shot with [: Cropping/aspect ratio] () set to [1:1 (aspect ratio)], [4:3 (aspect ratio)], or [16:9 (aspect ratio)].

RAW Image Processing Options

-  ±0: **Brightness adjustment**

You can adjust the image brightness up to ±1 stop in 1/3-stop increments.

-  **White balance** (🔗)

You can select the white balance. Selecting  enables you to select **[Auto: Ambience priority]** or **[Auto: White priority]**. If you select , you can set the color temperature.

-  **Picture Style** (🔗)

You can select the Picture Style. You can adjust the sharpness, contrast, and other parameters.

* , , , and  are not available when **[Set up processing→HEIF]** is set.

-  ±0: **Clarity** (🔗)

You can adjust clarity in a range of -4 to +4.

* Not available when **[Set up processing→HEIF]** is set.

-  **Auto Lighting Optimizer** (🔗) +  **Adj face lighting**

You can set the Auto Lighting Optimizer. With automatic, optimal adjustment of lighting on faces, you can effectively correct images captured with oblique lighting or illuminated by flash.

* Adjustment of face lighting is not available when **[Set up processing→HEIF]** is set.

Caution

When adjustment of face lighting is set

- Suitable adjustment may not be possible in some shooting situations unless faces can be detected in detail and are not too dark.
- Noise may increase.
- Adjustment may be less effective at high ISO speeds.

-  **High ISO speed NR** (🔗)

You can set the noise reduction processing for high ISO speeds. If the effect is difficult to discern, magnify the image (🔗).

● : Image quality

You can set the image quality when creating a JPEG or HEIF image.



● : sRGB: Color space

You can select either sRGB or Adobe RGB. Since the camera screen is not compatible with Adobe RGB, the difference in the image will hardly be perceptible when either color space is set.

* **[HDR PQ]** is displayed when **[Set up processing→HEIF]** is set but is not an option for selection.

● : Lens aberr correction

• OFF: **Peripheral illum corr**

A phenomenon that makes the image corners look darker due to the lens characteristics can be corrected. If **[Enable]** is set, the corrected image will be displayed. If the effect is difficult to discern, magnify the image  and check the four corners. Less correction is applied than for maximum correction with Digital Photo Professional (EOS software, ). If the effects of correction are not apparent, use Digital Photo Professional to apply the peripheral illumination correction.

• OFF: **Distortion correction**

Image distortion due to lens characteristics can be corrected. If **[Enable]** is set, the corrected image will be displayed. The image periphery will be trimmed in the corrected image.

Since the image resolution may look slightly lower, adjust the sharpness with the Picture Style's sharpness parameter setting as necessary.

• OFF: **Digital Lens Optimizer**

Correct lens aberration, diffraction, and low-pass filter-induced loss of resolution by applying optical design values. To check the effect of setting this option to **[High]** or **[Standard]**, use magnified view . Without magnification, the effect when Digital Lens Optimizer is set to **[High]** is not applied. Selecting **[High]** or **[Standard]** corrects both chromatic aberration and diffraction, although these options are not displayed.

• OFF: **Chromatic aberr corr**

Chromatic aberrations (color fringing along the subject's outline) due to the lens characteristics can be corrected. If **[Enable]** is set, the corrected image will be displayed. If the effect is difficult to discern, magnify the image .

•  OFF: **Diffraction correction** ()

The diffraction by the lens aperture degrading the image sharpness can be corrected. If **[Enable]** is set, the corrected image will be displayed. If the effect is difficult to discern, magnify the image () .

 **Caution**

- Processing RAW images in the camera will not produce exactly the same results as processing RAW images with Digital Photo Professional (EOS software).
- If you perform **[Brightness adjustment]**, noise, banding, etc. may be intensified with the effects of adjustment.
- When **[Digital Lens Optimizer]** is set, noise may be intensified together with the effects of correction.
- When **[Digital Lens Optimizer]** is set, image edges may be emphasized, under some shooting conditions. Adjust sharpness of the Picture Style as needed.
- Processing with **[Digital Lens Optimizer]** set to **[High]** may take some time.

 **Note**

- Effects of lens aberration correction vary by lens and by shooting conditions. Also, the effect may be difficult to discern depending on the lens used, shooting conditions, etc.
- RAW movies cannot be processed. Process them with Digital Photo Professional (EOS software).

Cloud RAW Image Processing

- [☑ Checking Processing Capacity](#)
- [☑ Adding Images to Process](#)
- [☑ Checking/Removing Selected Images](#)
- [☑ Uploading Images](#)

You can upload **RAW** or **CRAW** images to image.canon for processing into JPEG or HEIF images. The RAW images remain the same as when captured, so you can adjust the processing conditions to create multiple JPEGs or HEIFs.

Caution

- Complimentary enrollment at image.canon must be completed in advance. Note that cloud RAW image processing requires a paid subscription. For subscription details, visit the image.canon website.
- Images generated by this image processing are saved on image.canon servers. The processed images are not saved to the camera.

Note

- Before proceeding, connect the camera to image.canon ().

Checking Processing Capacity

You can check how many images you can process at image.canon.

1. Select [: Cloud RAW image processing].

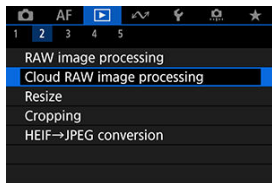

2. Select [Check proc. capacity (refresh)].

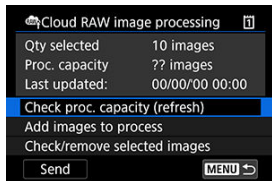

- The camera accesses image.canon.

3. Check the quantity in [Proc. capacity].

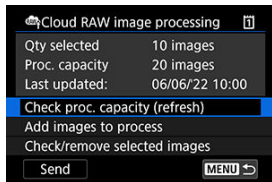

- Information in [**Proc. capacity**] is updated.

 Caution

- **[Proc. capacity]** is [0] unless you have a paid subscription for cloud RAW image processing. You will receive subscription information at the email address on record at image.canon if you check the processing capacity without a subscription.

1. Select [Add images to process].

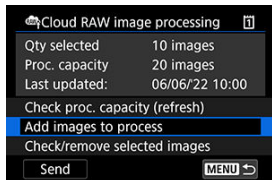



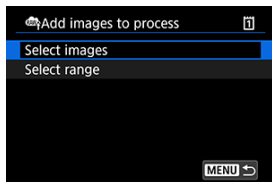

2. Select an option, then select images.

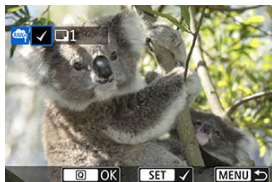

- You can select multiple images to process at once.

Select images



- Turn the <  > dial to select an image to process, then press the <  > button.
- Press the <  > button.

Select range



- Select the first image (start point).
- Next, select the last image (end point). A checkmark [✓] will be appended to all the images within the range between first and last images.
- To process other images, repeat this step.
- Press the <  > button.

3. Set the desired processing conditions.

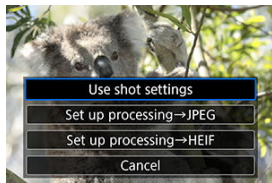

Use shot settings

- Images are processed using image settings at the time of capture.
- Images captured with [📷: HDR shooting **HDR PQ**] set to [Enable] are processed to create HEIFs, and images captured with this function set to [Disable] are processed to create JPEGs.

Set up processing→JPEG/Set up processing→HEIF

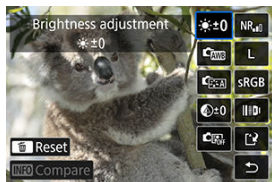

- Use < * > to select an item.
- Turn the < 🌀 > or < 🕒 > dial to switch the setting.
- Press the < Ⓢ > button to access the function setting screen.
- To return to the image settings at the time of shooting, press the < 🗑️ > button and select [OK] when "Revert to shot settings" is displayed.

Comparison screen

- You can switch between the [After change] and [Shot settings] screens by pressing the < INFO > button and turning the < 🕒 > dial.
- Items in orange on the [After change] screen have been modified since the time of capture.
- Press the < MENU > button to return to the processing conditions screen.

4. Select [Save].



- When using [Set up processing→JPEG] or [Set up processing→HEIF], select [] (Save).
- Read the message and select [OK].

5. Add to the upload list.

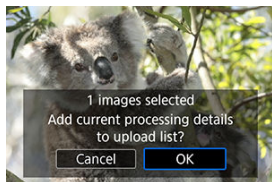



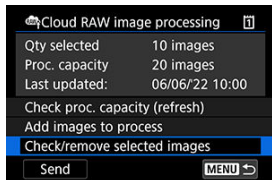

- Read the message and select [OK].

1. Select [Check/remove selected images].

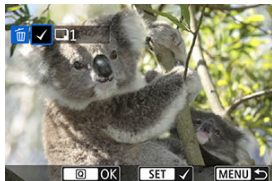

2. Browse your images.



- Turn the <  > dial to check images.
- To remove from the upload list, press the <  > button.
[✓] is displayed.
- To check image processing conditions, press the <  > button.

3. Remove the current image from the upload list as needed.

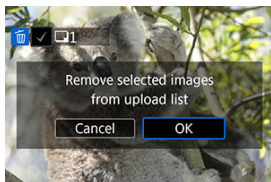

- Press the < MENU > button.
Select [OK] when a message is displayed about removing images from the upload list.

1. Select [Send].

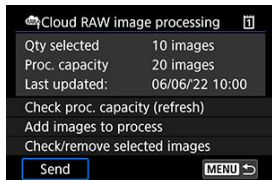

2. Read the message.



- Read the message, then tap **[Send]**.
- You will be notified at the email address on record for your Canon ID when your files have been received for processing and when processing is complete.

Caution

- The number of images and processing capacity may not be updated correctly if an **[Err 138]** transmission error occurs during uploading. Note that even if the number of images and processing capacity are not updated correctly, images may be processed on the server. Wait until you receive notification by email that processing is complete.
- The camera continues to upload images even if **[Stop]** is selected on the **[Send images]** screen. To cancel uploading, select **[OK]** on the **[Cancel transmission]** screen while the access lamp is blinking.
- Depending on when you select **[OK]** on the **[Cancel transmission]** screen, uploading may continue, and the images may be processed on the server.

Resizing JPEG/HEIF Images

You can resize a JPEG or HEIF image to reduce the pixel count and save it as a new image. Resizing is available for **L**, **M**, or **S1** JPEGs or HEIFs (in sizes except **S2**), including those captured in RAW+JPEG and RAW+HEIF shooting. **S2** images and RAW images or movies cannot be resized.

1. Select []: Resize].

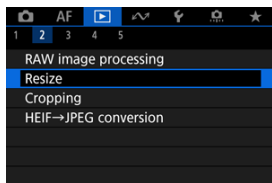

2. Select an image.

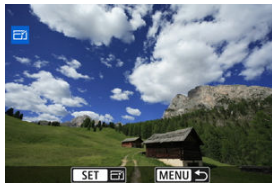

- Turn the < > dial to select the image to resize.

3. Select the desired image size.

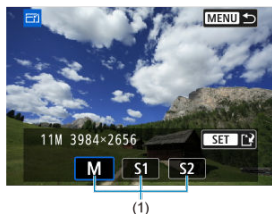

- Press < **SET** > to display the image sizes.
- Select the desired image size (1).

4. Save.

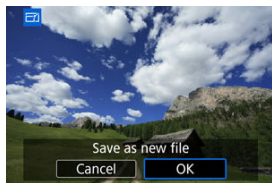

- Select [**OK**] to save the resized image.
- Check the destination folder and image file number, then select [**OK**].
- To resize another image, repeat steps 2 to 4.

Cropping JPEG/HEIF Images

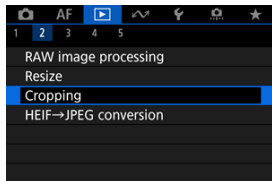

You can crop a captured JPEG/HEIF image and save it as a new image. Cropping is available for JPEG or HEIF images. RAW images and frame-grab images from 4K movies cannot be cropped.

1. Select []: Cropping].







2. Select an image.



- Turn the <  > dial to select the image to crop.
- Press <  > to display the cropping frame.

3. Set the cropping frame.



- The image area within the cropping frame will be cropped.
- **Resizing the cropping frame size**
Turn the <  > dial to resize the cropping frame size. The smaller the cropping frame, the more magnified the cropped image will look.
- **Changing the cropping frame aspect ratio and orientation**
Turn the <  > dial to change the cropping frame aspect ratio and orientation.
- **Moving the cropping frame**
Use <  > to move the cropping frame vertically or horizontally.
- **Correcting tilt**
You can correct image tilt by $\pm 10^\circ$. Press the < INFO > button. While checking tilt relative to the grid, turn the <  > dial (in 0.1° increments) or tap the left or right arrow (in 0.5° increments) in the upper left of the screen to correct tilt. After completing the tilt correction, press <  >.

4. Check the image area to be cropped.





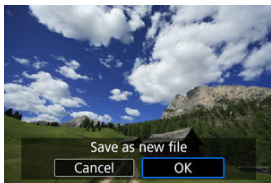

- Press the <  > button. The image area to crop is displayed.

5. Save.



- Press < **SET** > and select [**OK**] to save the cropped image.
- Check the destination folder and image file number, then select [**OK**].
- To crop another image, repeat steps 2 to 5.

Caution

- The position and size of the cropping frame may change depending on the angle set for tilt correction.
- Once a cropped image is saved, it cannot be cropped again or resized.
- AF point display information () and Dust Delete Data () will not be appended to the cropped images.
- Available aspect ratios vary depending on whether you use []: **Cropping**] or []: **Add cropping information**].

Converting HEIF to JPEG

[✔ Converting Individual Images](#)

[✔ Specifying the Range of Images to Convert](#)

You can convert HEIF images captured in HDR shooting and save them as JPEG images.

Note

- JPEGs converted from HEIF images are labeled with [JPEG↓] (when captured on this camera with firmware Ver. 1.2.0 or later installed).

Converting Individual Images

1. Select [▶]: HEIF→JPEG conversion].

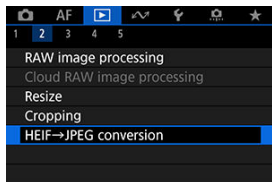

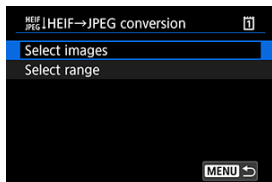

2. Select [Select images].

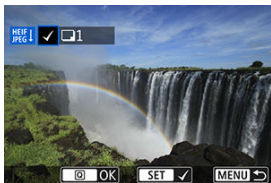

3. Select an image.



- Turn the <  > dial to select a HEIF image to convert to JPEG, then press the <  > button.
- To select another image to convert, repeat step 3.
- Press the <  > button to convert to JPEG.

4. Save.

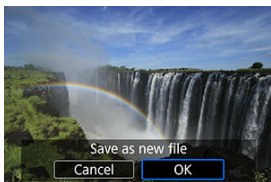

- Select [**OK**] to save the JPEG image.
- If there are other images for conversion, select [**Yes**].

5. Select the images to use for display.

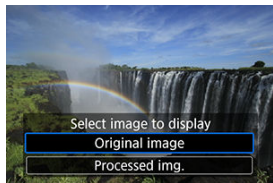

- Select [**Original image**] to use the original HEIF images for display.
- Select [**Processed img.**] to use the converted JPEG images for display.



Note

- Some scenes may look different after conversion if the original and converted images are compared.
- Conversion is not available for cropped images, or for frame-grab images from 4K movies.

Specifying the Range of Images to Convert

1. Select [Select range].

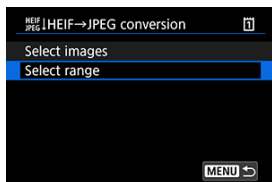

2. Specify the range of images.

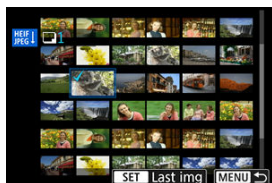

- Select the first image (start point).
- Next, select the last image (end point). A checkmark [✓] will be appended to all the images within the range between first and last images.
- To select other images, repeat step 2.

3. Press the <Q> button.

4. Save.

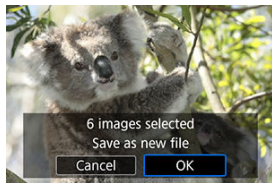

- Select **[OK]** to save the JPEG image.
- If there are other images for conversion, select **[Yes]**.

5. Select the images to use for display.



- Select **[Original image]** to use the original HEIF images for display.
- Select **[Processed img.]** to use the converted JPEG images for display.

Note

- Some scenes may look different after conversion if the original and converted images are compared.
- Conversion is not available for cropped images, or for frame-grab images from 4K movies.

Slide Show

You can play back the images on the card as an automatic slide show.

1. Specify the images to be played back.

- To play back all the images on the card, go to step 2.
- If you want to specify the images to be played back in the slide show, filter the images with [▶]: **Set image search conditions** (🔗).

2. Select [▶]: **Slide show**.

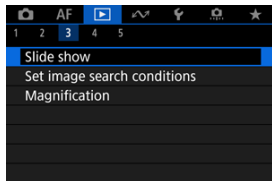

3. Set the playback as desired.

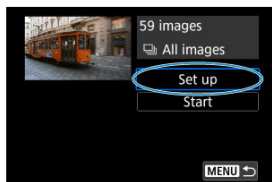

- Select [**Set up**].
- Set the [**Display time**] and [**Repeat**] (repeated playback) settings for the still photos.
- After completing the settings, press the <MENU> button.

Display time

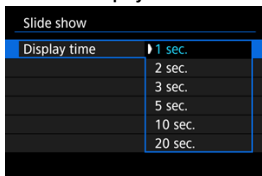

Repeat

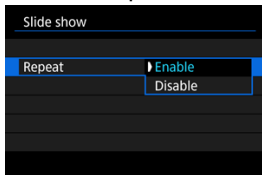

4. Start the slide show.

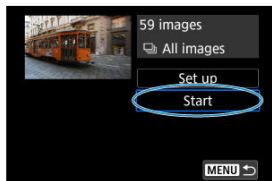







- Select [**Start**].
- After [**Loading image...**] is displayed, the slide show will start.

5. Exit the slide show.

- To exit the slide show and return to the setting screen, press the < **MENU** > button.

Note

- To pause the slide show, press <  >. During pause,  will be displayed in the upper left of the screen. Press <  > again to resume the slide show.
- During the automatic playback of still photos, you can press the < **INFO** > button to switch the display format ().
- During movie playback, you can adjust the sound volume by turning the <  > dial.
- During auto playback or when playback is paused, you can turn the <  > dial to view another image.
- During auto playback, auto power off will not take effect.
- The display time may differ depending on the image.

Setting Image Search Conditions

[Clearing the Search Conditions](#)

You can filter image display according to your search conditions. After setting the image search conditions, you can play back and display only the found images. You can also protect, rate, play a slide show, erase, and apply other operations to filtered images.

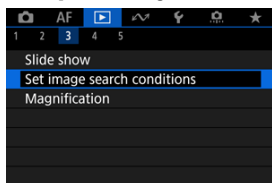

1. Select [: Set image search conditions].

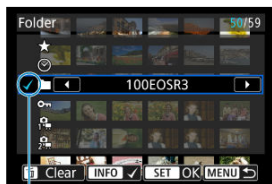

2. Set the search conditions.



(1)

- Turn the <  > dial to select an option.
- Turn the <  > dial to set the option.
- A checkmark [✓] (1) is appended to the left of the option. (Specified as the search condition.)
- If you select the option and press the < INFO > button, the checkmark [✓] will be removed (which cancels the search condition).

Option	Description
★ Rating	Displays images with the selected (rating) condition.
📅 Date	Displays images taken on the selected shooting date.
📁 Folder	Displays images in the selected folder.
🔒 Protect	Displays images with the selected (protect) condition.
📄 Type of file (1)	Displays images of the selected file type.
📄 Type of file (2)	

3. Apply the search conditions.

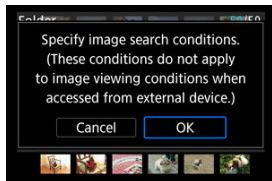

- Press < SET > and read the message displayed.
- Select [OK].
The search condition is applied.

4. Display the found images.



(2)

- Press the <  > button.
Only the images that match the set conditions (filtered) will be played back.
When the images are filtered for display, the screen will have an outer yellow frame (2).

Caution

- If no images match the search conditions, <  > cannot be pressed in step 3.

Note



- Search conditions may be cleared after operations involving camera power or card changes and editing, adding, or erasing images.
- Auto power off time may be extended while the [: **Set image search conditions**] screen is displayed.

Clearing the Search Conditions

Access the screen in step 2, then press the <  > button to clear all the search conditions.

Browsing Images with the Main Dial

In single-image display, you can turn the <  > dial to jump through the images forward or backward according to the jump method set.



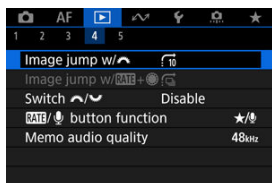

1. Select [: Image jump w/].

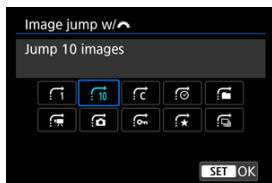

2. Select the jump method.





Note

- With [**Jump images by the specified number**], you can turn the <  > dial to select the number of images to jump by.
- With [**Display by image rating**], turn the <  > dial to select the rating (). Selecting  will show all rated images as you browse.

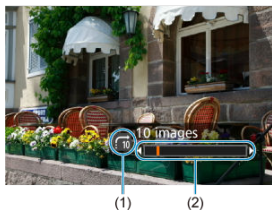

3. Browse by jumping.



- (1) Jump method
- (2) Playback position

- Press the <  > button.
- In single-image display, turn the <  > dial.
You can browse by the jump method set.

Browsing Images with the Rate+Quick Control Dial 1





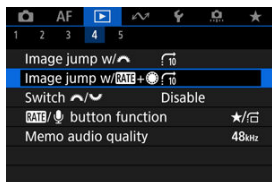

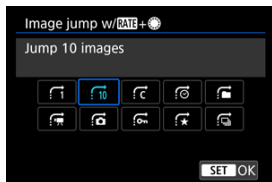

In single-image display, you can turn the <  > dial while holding down the < **RATE** /  > button to jump through the images forward or backward according to the jump method set.

1. Select []: Image jump w/**RATE**+.



2. Select the jump method.



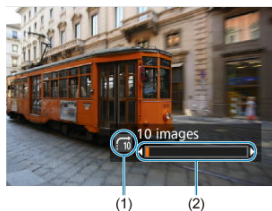

- You can configure this feature when []: **RATE**/ **button function**] is set to [/] or [
- With [**Jump images by the specified number**], you can turn the <  > dial to select the number of images to jump by.
- With [**Display by image rating**], turn the <  > dial to select the rating (). Selecting  will show all rated images as you browse.

3. Browse by jumping.





- (1) Jump method
- (2) Playback position

- Press the <  > button.
- In single-image display, turn the <  > dial while holding down the < **RATE** /  > button.
You can browse by the jump method set.

Switching the Main Dial and Quick Control Dial 2



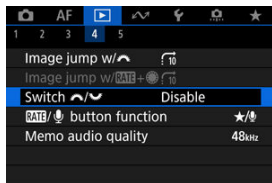

You can switch the functions assigned to these dials, as used on the image playback screen.

1. Select [▶]: Switch  .

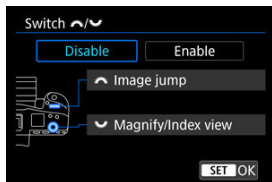

2. Select an option.





- **Disable**
 Image jump
 Magnify/Index view
- **Enable**
 Magnify/Index view
 Image jump

Note









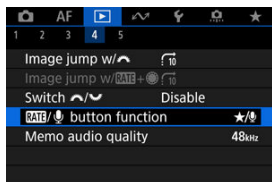























- Corresponding icons in menus and on screens such as the Quick Control and Magnify/Reduce screen are changed accordingly.

Rate/Voice Memo Button Function

You can assign image rating/protection/erasure, voice memo recording/playback, or image browsing in conjunction with the <  > dial to the < **RATE** /  > button.

1. Select []: **RATE**/ button function].



- : **Record voice memo / Rating disabled**
Assigns voice memo recording to the < **RATE** /  > button.
During image playback, you can start recording a voice memo by pressing the < **RATE** /  > button.
-  / : **Play voice memo / Hold to record voice memo**
Assigns voice memo playback to the < **RATE** /  > button.
During image playback, you can play a voice memo by pressing the < **RATE** /  > button. You can also hold it down for 2 sec. to start recording a voice memo.
-  / : **Protect / Hold to record voice memo**
Assigns protection to the < **RATE** /  > button.
During playback, you can protect images or clear protection by pressing the < **RATE** /  > button. You can also hold it down for 2 sec. to start recording a voice memo.
- : **Erase images**
Assigns erasure to the < **RATE** /  > button.
During image playback, you can erase images by pressing the < **RATE** /  > button.
-  / : **Rating / Browse images: Hold down+turn** 
Assigns rating to the < **RATE** /  > button.
You can specify ratings available with the < **RATE** /  > button by pressing the <  > button.
During image playback, you can browse images by turning the <  > dial while holding down the < **RATE** /  > button. The number of images to jump is set in [: **Image jump w/[RATE]+**].
-  / : **Protect / Browse images: Hold down+turn** 
Assigns protection to the < **RATE** /  > button.
During image playback, you can browse images by turning the <  > dial while holding down the < **RATE** /  > button. The number of images to jump is set in [: **Image jump w/[RATE]+**].

Customizing Playback Information Display

[Histogram](#)

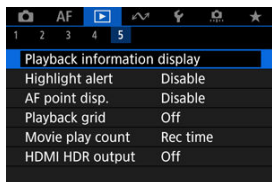

You can specify screens and accompanying information displayed during image playback.

1. Select []: Playback information display].



2. Add a checkmark [✓] next to the number of screens to display.



- Select numbers with the < > dial.
- Press < > to clear a checkmark [✓]. Press it again to add a checkmark [✓].
- Repeat these steps to add a checkmark [✓] to the number of each screen to display, then select [OK].
- Your selected information can be accessed by pressing the <INFO> button during playback, or by using < > when shooting information is displayed.

Histogram

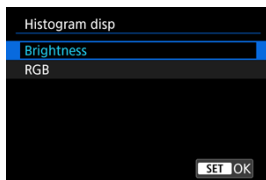

The histograms show signal levels across the tonal range. Brightness display (for checking the general exposure level and overall gradation) and RGB display (for checking saturation and gradation of red, green, and blue) are available. You can switch the histogram displayed by pressing the <INFO> button when [INFO] is displayed in the lower left of the [▶]: **Playback information display** screen.

- **[Brightness] display**

This histogram is a graph showing the distribution of the image's brightness level, with the horizontal axis indicating the brightness level (darker on the left and brighter on the right) and the vertical axis indicating the pixel count at each brightness level. The more pixels there are toward the left, the darker the image, and the more pixels there are toward the right, the brighter the image. If there are too many pixels on the left, detail in shadows will be lost, and if there are too many pixels on the right, detail in highlights will be lost. The gradation in-between will be reproduced. By checking the image and its brightness histogram, you can see the exposure level inclination and the overall gradation.

Sample histograms



Dark image



Normal brightness



Bright image

- **[RGB] display**

This histogram is a graph showing the distribution of each primary color's brightness level in the image (RGB or red, green, and blue), with the horizontal axis indicating the color's brightness level (darker on the left and brighter on the right) and the vertical axis indicating the pixel count at each color brightness level. The more pixels there are toward the left, the darker and less prominent the color, and the more pixels there are toward the right, the brighter and denser the color. If there are too many pixels on the left, the corresponding color information will be lacking, and if there are too many pixels on the right, the color will be too saturated, without gradation. By checking the image's RGB histogram, you can see the color's saturation and gradation conditions, as well as the white balance bias.

Displaying the Highlight Alert

You can specify blinking display of overexposed highlights on the playback screen. To obtain more detailed gradation in the blinking areas where you want the gradation to be faithfully reproduced, set the exposure compensation to a negative amount and shoot again for a better result.

1. Select [: Highlight alert].

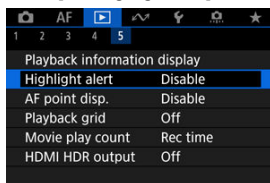

2. Select [Enable].

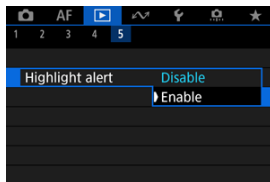

AF Point Display

You can display the AF points that were used to focus, which will be outlined in red on the playback screen.

1. Select []: AF point disp.].

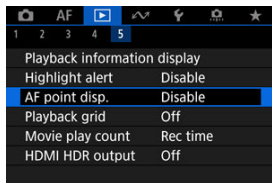

2. Select [Enable].

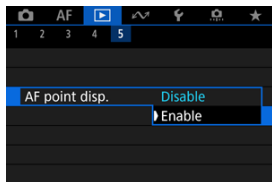

Playback Grid

You can display a grid over still photos shown in single-image display on the playback screen. This function is convenient for checking the image's vertical or horizontal tilt as well as composition.

1. Select [▶]: Playback grid].

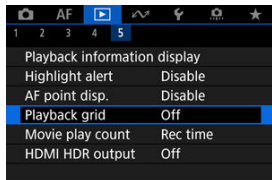

2. Select an option.

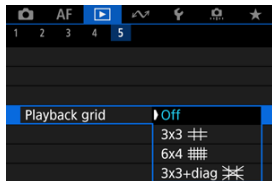

Movie Play Count

You can select how time is displayed on the movie playback screen.

1. Select [▶]: Movie play count].

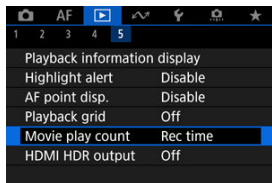

2. Select an option.

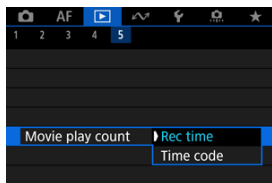

- **Rec time**

Displays the recording or playback time during movie playback.



- **Time code**

Displays the time code during movie playback.



Note

- Time codes are always recorded to movie files (except when High Frame Rate movies are set to **[Free run]**), regardless of the **[Movie rec count]** setting.
- The **[Movie play count]** setting in **[CAMERA]: Time code** is linked to the **[PLAYBACK]: Movie play count**, so that these settings always match.
- The “frame” count is not displayed during movie recording or playback.

HDMI HDR Output

You can view RAW or HEIF images in HDR by connecting the camera to an HDR TV.

1. Select [▶]: HDMI HDR output].

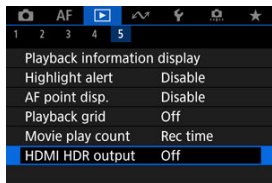

2. Select [On].

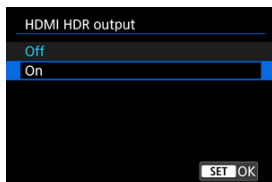

Note

- Make sure the HDR TV is set up for HDR input. For details on how to switch inputs on the TV, refer to the TV manual.
- Depending on the TV used, images may not look as expected.
- On HDR TVs, some information may not be displayed.
- Quick Control RAW processing of displayed images is recommended if you will process RAW images while viewing HDMI HDR output.

Communication Functions

This chapter describes how communication functions are used to connect the camera to a smartphone or computer over Wi-Fi or a wired LAN and send images, control the camera remotely, or perform other operations.

Caution

Important

- Note that Canon cannot be held liable for any loss or damage caused by erroneous network settings when using the camera. In addition, Canon cannot be held liable for any other loss or damage caused by use of the camera.
Take security measures that you deem necessary when using a network, at your discretion. Canon cannot be held liable for any loss or damage caused by unauthorized access or other security breaches.

- [Tab Menus: Communication Functions Tab](#)
- [Available Communication Functions](#)
- [Camera Connect Communication from Smartphones](#)
- [Wi-Fi Connections with a Computer Using EOS Utility](#)
- [Basic Communication Settings](#)
- [Image Transfer to FTP Servers](#)
- [Sending Images to a Web Service](#)
- [Remote Control \(EOS Utility\)](#)
- [Controlling the Camera with Browser Remote](#)
- [Ending Connections or Reconnecting](#)
- [Airplane Mode](#)
- [Checking and Editing Network Settings](#)
- [Syncing Time Between Cameras](#)
- [Setting Up GPS Features](#)
- [Connecting to a Wireless Remote Control](#)
- [Reference](#)
- [Troubleshooting](#)
- [Save/Load Communication Settings on Card](#)
- [Resetting Communication Settings](#)

Tab Menus: Communication Functions Tab

● Wireless features 1

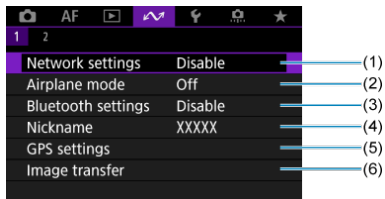

- (1) [Network settings](#)
- (2) [Airplane mode](#)
- (3) Bluetooth settings
 - [Smartphone](#)
 - [Remote](#)
- (4) [Nickname](#)
- (5) [GPS settings](#)
- (6) [Image transfer](#)

● Wireless features 2

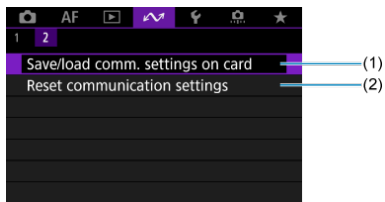

- (1) [Save/load comm. settings on card](#)
- (2) [Reset communication settings](#)

 **Caution**

- Some menu items cannot be configured while the camera is connected to a computer or other device via an interface cable.
- Network connections are terminated if you switch camera to < **OFF** > or open the card slot cover.
- Auto power off is not activated while connected to a network.

Available Communication Functions

Smartphone (🔗)

Using the dedicated Camera Connect app on smartphones or tablets (hereafter, collectively referred to as “smartphones”), you can browse images on the camera, shoot remotely, and perform other operations. After pairing the camera with a smartphone supporting Bluetooth low energy technology (hereafter, “Bluetooth”), you only need to use the smartphone to connect via Wi-Fi.

EOS Utility

Using EOS Utility (EOS software installed on a computer), you can import images from the camera, shoot remotely, and perform other operations.

- See [Wi-Fi Connections with a Computer Using EOS Utility](#) for instructions on joining a Wi-Fi network via an access point compatible with WPS (PBC mode) to connect the camera to a computer.
- See instructions starting with [Basic Communication Settings](#) for other ways to connect the camera to a computer wirelessly or over a wired LAN connection.

FTP transfer (🔗)

Your shots can be transferred to an FTP server.

Besides automatically transferring images as you shoot, you can manually select and transfer images later.

Browser Remote (🔗)

From a computer or smartphone browser, connecting to the camera is like accessing a webpage, and you can shoot remotely, browse camera images, or configure FTP transfer settings.

Syncing time between cameras (🔗)

The time on multiple EOS R3 cameras can be synchronized over a wired LAN connection.

GPS (🔗)

Built-in GPS features can be used to geotag images, log routes traveled with the camera, and more.

Available communication functions and connection methods (besides GPS)

Available Features	Connection Method	
	Wired LAN	Wi-Fi (Built-In)
Camera Connect communication from smartphones		○
Using EOS Utility	○	○
Image transfer to FTP servers	○	○
Using Browser Remote	○	
Syncing time between cameras	○	

Camera Connect Communication from Smartphones

- [✔ Connecting to a Bluetooth-compatible Smartphone via Wi-Fi](#)
- [✔ Main Functions of Camera Connect](#)
- [✔ Canceling the Pairing](#)
- [✔ Wi-Fi Connection Without Using Bluetooth](#)
- [✔ Automatic Image Transfer as You Shoot](#)
- [✔ Sending Images to a Smartphone from the Camera](#)
- [✔ Settings to Make Images Viewable from Smartphones](#)
- [✔ General Precautions on Camera Connect Communication from Smartphones](#)

By using the dedicated Camera Connect app installed on a smartphone or tablet (collectively referred to hereafter as “smartphones”), you can connect the smartphone and camera via Wi-Fi.

Features available over a Bluetooth connection

- You can establish a Wi-Fi connection using only a smartphone.
- You can shoot still photos or record movies by using your smartphone as a remote control.

Features available over a Wi-Fi connection

- You can use a smartphone to browse images on the camera and save them to the smartphone.
- You can control the camera remotely from a smartphone.
- You can use the camera to send images to a smartphone.
- The dedicated app Camera Connect (free of charge) must be installed on the smartphone on which Android or iOS is installed. Camera Connect can be installed from Google Play or App Store.

Caution

- Use the latest version of the smartphone OS.

Note

- You can also access Google Play or App Store from QR codes displayed when you pair the smartphone and camera.
- For the operating system versions supported by Camera Connect, refer to the download site of Camera Connect.
- Sample screens and other details in this guide may not match the actual user interface elements after camera firmware updates or updates to Camera Connect, Android, or iOS.

Connecting to a Bluetooth-compatible Smartphone via Wi-Fi

These instructions describe how to establish a Wi-Fi connection with a Bluetooth enabled smartphone and use Camera Connect to control the camera.

Caution

- Bluetooth pairing with a smartphone is not possible while the camera is connected to other devices via Wi-Fi or connected to a wireless LAN. End the Wi-Fi or wireless LAN connection by selecting [**Connection settings**] in [: **Network settings**], then selecting [**Disconnect**].

Steps on the smartphone (1)

Turn on Bluetooth and Wi-Fi from the smartphone settings screen. Note that pairing with the camera is not possible from the smartphone's Bluetooth settings screen.

Steps on the camera (1)

1. On the camera, press the <MENU> button.

2. Select [**MENU**]: Network settings].

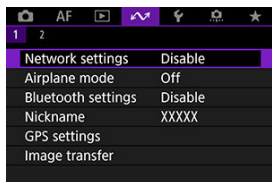

3. In [Network], select [Enable].

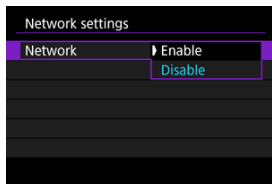

4. Press the <MENU> button and select [**MENU**]: Bluetooth settings].

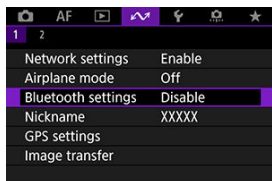

5. In [Bluetooth], select [Smartphone].

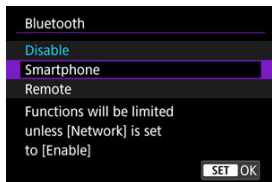

6. Select [Pairing].

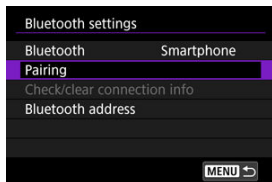

7. Select an option.

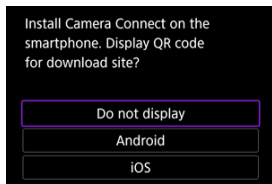

- If Camera Connect is already installed, select [**Do not display**].
- If Camera Connect is not installed, select [**Android**] or [**iOS**], scan the displayed QR code with the smartphone to access Google Play or App Store and install Camera Connect.

Steps on the smartphone (2)

8. Start Camera Connect.
9. Tap the camera for pairing.
 - If you are using an Android smartphone, go to step 11.
10. Tap [Pair] (iOS only).

Steps on the camera (2)

11. Select [OK].



12. Press the <SET> button.



- Pairing is now complete, and the camera is connected to the smartphone via Bluetooth.

Caution

- Bluetooth connection consumes battery power even after the camera's auto power off is activated. Therefore, the battery level may be low when you use the camera.
- The camera can be paired with one smartphone. Before pairing with a different smartphone, clear the information about the currently paired smartphone (🗑).
- Keeping pairing records for previously paired cameras on your smartphone will prevent it from pairing with this camera. Before you try pairing again, remove pairing records for previously paired cameras from your smartphone's Bluetooth settings screen.



Note

- When paired via Bluetooth, tap **[Bluetooth remote controller]** in Camera Connect to control the camera remotely from the smartphone.
- From an Android device, you can control the camera to send images to the smartphone (📷).

Steps on the smartphone (3)

13. Tap a Camera Connect function.

- In iOS, tap **[Join]** when a message is displayed to confirm camera connection.
- After the devices are connected via Wi-Fi, a screen for the selected function is displayed on the smartphone.
- The camera's <LAN> lamp is lit in green.

Terminating Wi-Fi connections

- Terminating the Wi-Fi connection will switch the camera to the Bluetooth connection.

Reconnecting

- To reconnect via Wi-Fi, start Camera Connect and tap the function you will use.

Main Functions of Camera Connect

Images on camera

- Images can be browsed, deleted, or rated.
- Images can be saved on a smartphone.

Remote live view shooting

- Enables remote shooting as you view a live image on the smartphone.

Auto transfer

- Enables camera and app setting adjustment for automatic transfer of your shots ()

Bluetooth remote controller

- Enables remote control of the camera from a smartphone paired via Bluetooth. (Not available when connected via Wi-Fi.)
- Auto power off is disabled while you are using the Bluetooth remote controller feature.

Camera settings

- Camera settings can be changed.

You can check other functions from the main Camera Connect screen.

Canceling the Pairing

Cancel pairing with a smartphone as follows.

1. Select [Check/clear connection info].

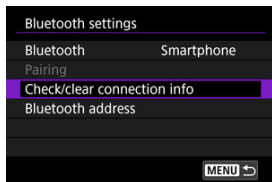

2. Press the <INFO> button.

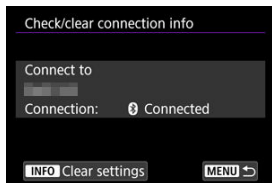

3. Select [OK].

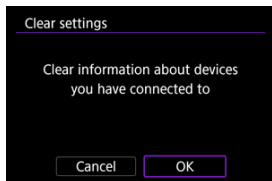

4. Clear the camera information on the smartphone.

- In the smartphone's Bluetooth setting menu, clear the camera information registered on the smartphone.



Note

- To check the camera's Bluetooth address, select **[Bluetooth address]**.

Wi-Fi Connection Without Using Bluetooth

These instructions describe how to establish a direct Wi-Fi connection with a smartphone and use Camera Connect to control the camera.

Steps on the camera (1)

1. On the camera, press the <MENU> button.
2. Select [: Network settings].

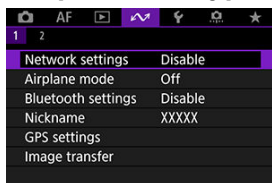

3. In [Network], select [Enable].

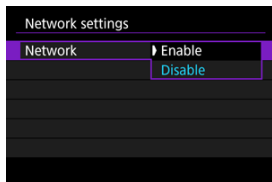

4. Select [Connection settings].

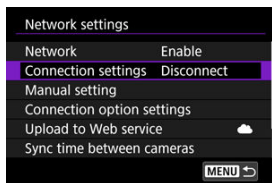

5. Select [SET* Unspecified].

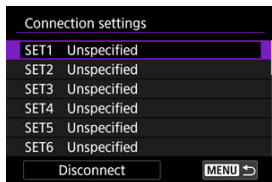

6. Select [Create with wizard].

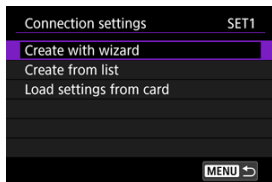

7. Select [Configure online].

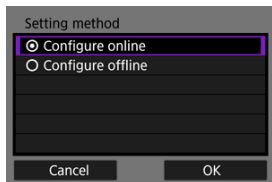

- Select [OK].

8. Select [Smartphone].

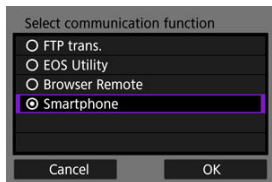

- Select [OK].

9. Press the <SET> button.

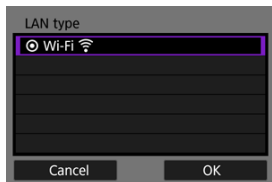

- Select [OK].

10. Select [New settings].

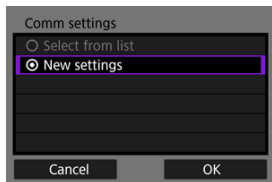

- Select [OK].

11. Select [Camera access point mode].

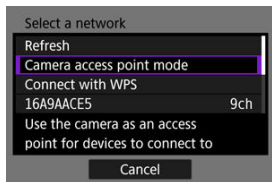

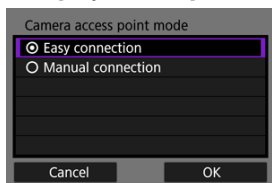

12. Select [Easy connection].

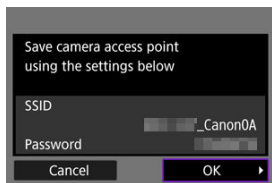

- Select [OK].

13. Select [OK].



14. Press the <  > button.

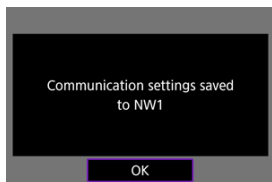

15. Select [New settings].

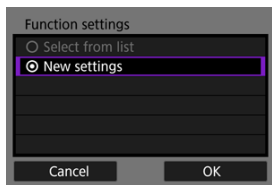

- Select [OK].

16. Check the SSID (network name) and password.

- Check the SSID (1) and password (2) displayed on the camera screen.

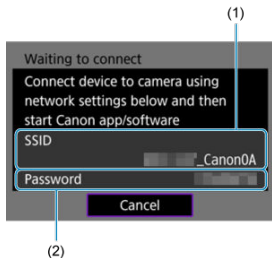

Steps on the smartphone

17. Operate the smartphone to establish a Wi-Fi connection.

- Activate the smartphone's Wi-Fi function, then tap the SSID (network name) you checked in step 16.
- In the password field, enter the password you checked in step 16, then tap [Join].

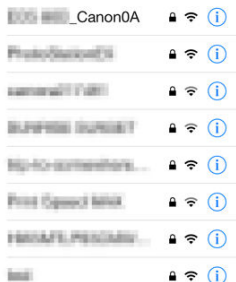

18. Start Camera Connect and tap the camera to connect to via Wi-Fi.

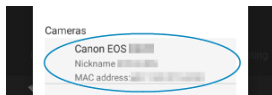

Steps on the camera (2)

19. Select [OK].

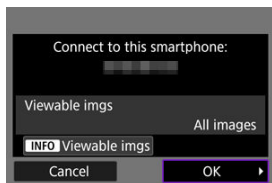

- To specify viewable images, press the <INFO> button. For details on conditions that enable image viewing, see [Settings to Make Images Viewable from Smartphones](#).

20. Press <SET>.

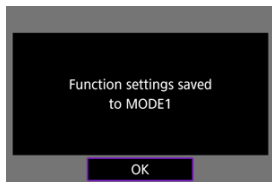

21. Press <SET>.

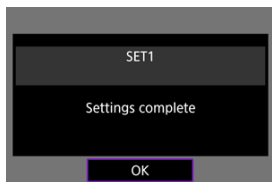

- The main window of Camera Connect will be displayed on the smartphone.
- The camera's <LAN> lamp is lit in green.
The Wi-Fi connection to a smartphone is now complete.
- Operate the camera using Camera Connect (🔗).
- When connected via Wi-Fi, you can send images to a smartphone from the Quick Control screen during playback (🔗).

Terminating Wi-Fi connections (🔗)

Reconnecting (🔗)

Automatic Image Transfer as You Shoot

Your shots can be automatically sent to a smartphone. Before following these steps, make sure the camera and smartphone are connected via Wi-Fi.

1. Select [: Network settings].

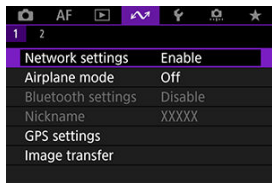

2. Select [Connection option settings].

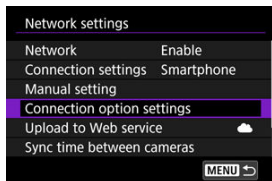

3. Select [Smartphone settings].

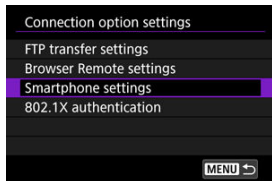

4. Select [Send to smartphone after shot].

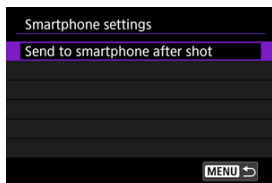

5. Set [Auto send] to [Enable].

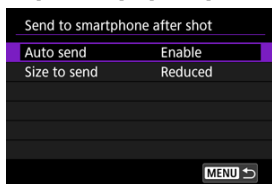

- If necessary, specify [Size to send].

Sending Images to a Smartphone from the Camera

You can use the camera to send images to a smartphone paired via Bluetooth (Android devices only) or connected via Wi-Fi.

If you will send many images, consider using a household power outlet accessory (sold separately).

1. Switch to playback.

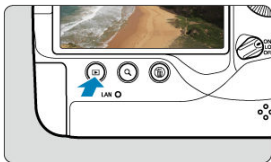

2. Press the <Q> button.

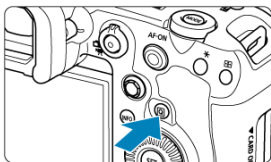

3. Select [Send images to smartphone].

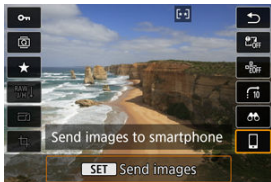





- If you perform this step while connected via Bluetooth, a message is displayed, and the connection switches to a Wi-Fi connection.

4. Select sending options and send the images.

Sending images individually

1. Select an image to send.



- Turn the <  > dial to select images to send, then press <  >.
- You can press the <  > button and turn the <  > dial counterclockwise to select the image using the index display.

2. Select [Send img shown].

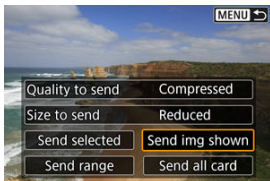

- In [**Size to send**], you can select the image sending size.

Sending multiple selected images

1. Press < SET >.



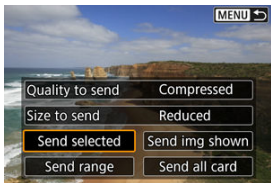

2. Select [Send selected].







3. Select images to send.

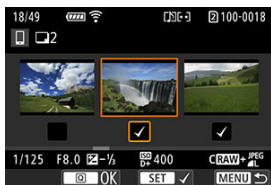

- Turn the <  > dial to select images to send, then press <  >.



- To switch to three-image display for image selection, press the <  > button and turn the <  > dial counterclockwise. To return to the single-image display, press the <  > button.
- After selecting the images to send, press the <  > button.

4. Select [Size to send].

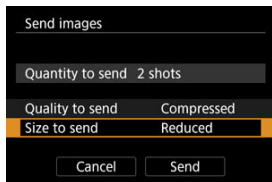

- On the displayed screen, select an image size.

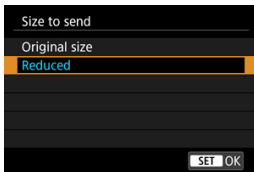

5. Select [Send].

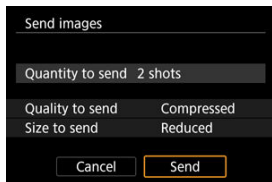

Sending a specified range of images

1. Press <SET>.



2. Select [Send range].

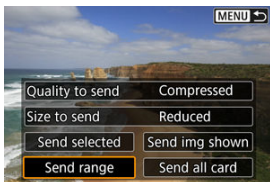

3. Specify the range of images.

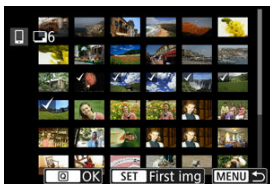

- Select the first image (start point).
- Select the last image (end point).
- To cancel the selection, repeat this step.
- To change the number of images in index display, press the <Q> button, then turn the <Q> dial.

4. Confirm the range.

- Press the < Q > button.

5. Select [Size to send].

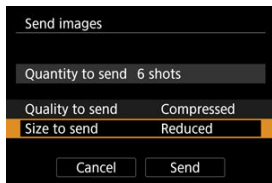

- On the displayed screen, select an image size.

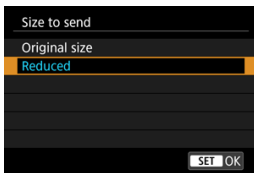

6. Select [Send].

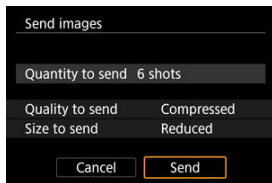

Sending all images on the card

1. Press <SET>.



2. Select [Send all card].

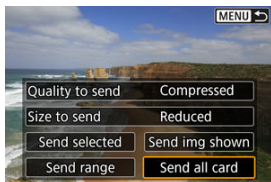

3. Select [Size to send].

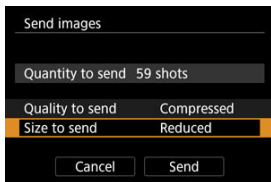

- On the displayed screen, select an image size.

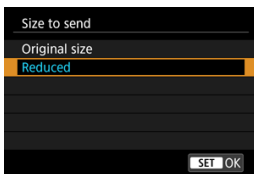

4. Select [Send].

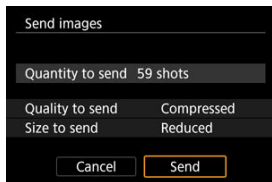

Sending images that match the search conditions

Send all the images that match the search conditions set in [▶]: **Set image search conditions**] at once. For details on [Set image search conditions], see [Setting Image Search Conditions](#).

1. Press <SET>.



2. Select [Send all found].

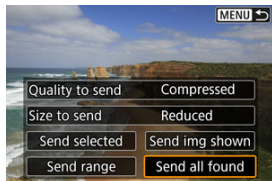

3. Select [Size to send].

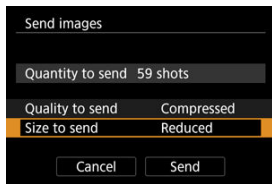

- On the displayed screen, select an image size.

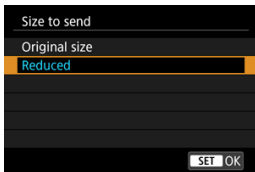

4. Select [Send].

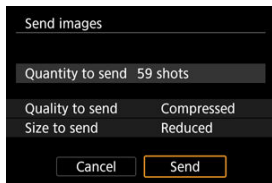

Ending image transfer (🔒)

⚠ Caution

- During the image transfer operation, a picture cannot be taken even if the camera's shutter button is pressed.

 **Note**

- You can cancel the image transfer by selecting **[Cancel]** during the transfer.
- You can select up to 999 files at a time.
- With a Wi-Fi connection established, disabling the smartphone's power saving function is recommended.
- Selecting the reduced size for still photos applies to all still photos sent at that time. Note that **S2** size still photos are not reduced.
- Selecting compression for movies applies to all movies sent at that time. Note that **FHD 29.97P (IPB)** and **FHD 25.00P (IPB)** movies are not reduced.
- When you use a battery to power the camera, make sure it is fully charged.

Settings to Make Images Viewable from Smartphones

Images can be specified after the Wi-Fi connection is terminated.

1. Select [**W**: Network settings].

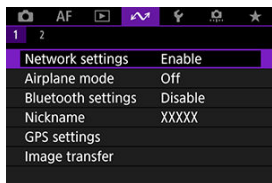

2. Select [**M**: Manual setting].

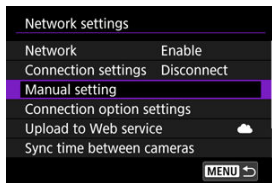

3. Select [**F**: Function settings].

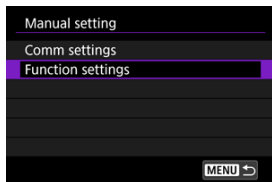

4. Select [Smartphone].

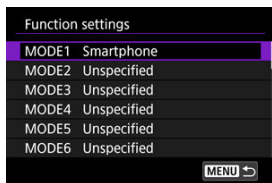

5. Select [Change].

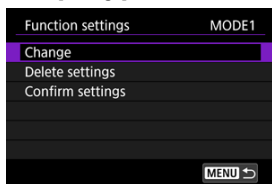

6. Select [Viewable imgs].

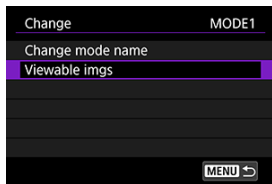

7. Select an option.

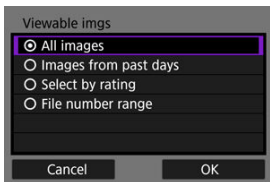

- Select **[OK]** to access the setting screen.

[All images]

All images stored on the card become viewable.

[Images from past days]

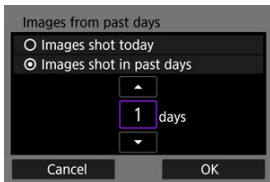

Specify viewable images on the shooting-date basis. Images shot up to nine days ago can be specified.

- When **[Images shot in past days]** is selected, images shot up to the specified number of days before the current date become viewable. Use the **[▲]** **[▼]** keys to specify the number of days, then press **< (SET) >** to confirm the selection.
- Once you select **[OK]**, the viewable images are set.

⚠ Caution

- If **[Viewable imgs]** is set to any setting other than **[All images]**, remote shooting is not possible.

[Select by rating]

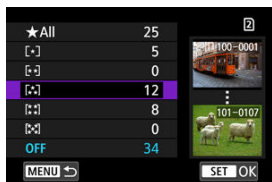

Specify viewable images depending on whether a rating is appended (or not appended) or by the type of rating.

- Once you select the type of rating, the viewable images are set.

[File number range] (Select range)

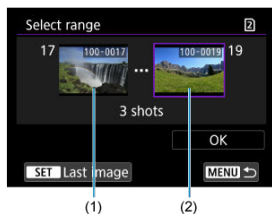



Select the first and last images from images arranged by the file number to specify the viewable images.

1. Press $\langle \text{SET} \rangle$ to display the image selection screen.
Use the $\langle \text{DIAL} \rangle$ dial to select images.
You can press the $\langle \text{Q} \rangle$ button and turn the $\langle \text{DIAL} \rangle$ dial counterclockwise to select the image using the index display.
2. Select an image as the starting point (1).
3. Use the $\langle \text{DIAL} \rangle$ dial to select an image as the ending point (2).
4. Select **[OK]**.

General Precautions on Camera Connect Communication from Smartphones

Caution

- If the Wi-Fi connection is terminated while recording a movie with remote shooting, the following will occur.
 - If the still photo shooting/movie recording switch is set to <  >, movie recording will continue.
 - If the still photo shooting/movie recording switch is set to <  >, movie recording will stop.
- With a Wi-Fi connection to a smartphone established, certain functions are unavailable.
- In remote shooting, the AF speed may become slower.
- Depending on the communication status, image display or shutter release timing may be delayed.
- When saving images to a smartphone, you cannot take a picture even if you press the camera's shutter button. Also, the camera screen may turn off.

Note

- With a Wi-Fi connection established, disabling the smartphone's power saving function is recommended.

Wi-Fi Connections with a Computer Using EOS Utility

[Connecting to a Computer via Wi-Fi](#)

Using EOS Utility, you can browse images on the camera and save them to the computer. Also in EOS Utility, you can shoot by controlling the camera remotely and change camera settings.

Install EOS Utility on the computer before connecting via Wi-Fi ().

Connecting to a Computer via Wi-Fi

This section describes how to prepare for camera operations in EOS Utility by connecting the camera and a computer via Wi-Fi using a WPS (PBC mode) compatible access point.

- First, check the position of the WPS button and how long to press it.
- It may take approx. 1 min. to establish a Wi-Fi connection.
- For computer operating instructions, refer to the computer user manual.
- See the instructions starting in [Basic Communication Settings](#) for details on connecting the camera to a wired LAN or using non-WPS (PBC mode) access points.

Steps on the camera (1)

1. On the camera, press the <MENU> button.
2. Select []: Network settings].

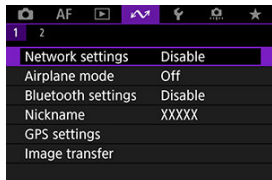

3. In [Network], select [Enable].

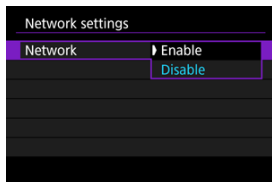

4. Select [Connection settings].

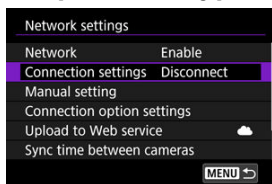

5. Select [SET* Unspecified].

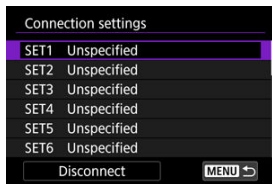

6. Select [Create with wizard].

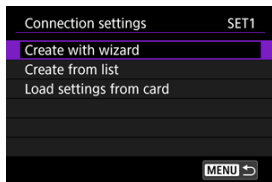

7. Select [Configure online].

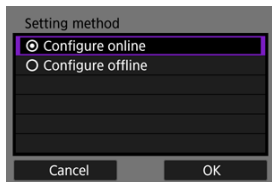

- Select [OK].

8. Select [EOS Utility].

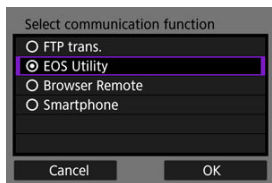

- Select [OK].

9. Select [Wi-Fi].

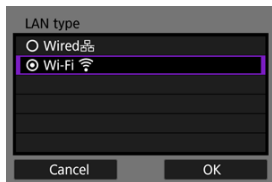

- Select [OK].

10. Select [New settings].

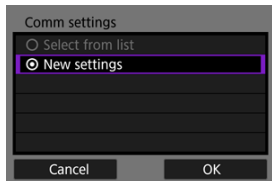

- Select [OK].

11. Select [Connect with WPS].

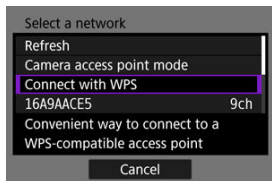

12. Select [WPS (PBC mode)].

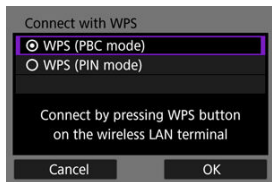

- Select [OK].

Steps on the access point

13. Connect to the access point via Wi-Fi.

- Press the access point's WPS button.

Steps on the camera (2)

14. Select [OK].

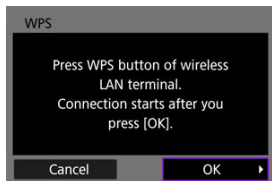

15. Select [Auto setting].

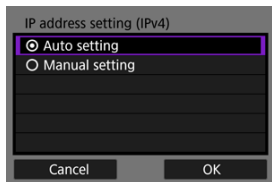

- Select [OK].

16. Select [Disable].

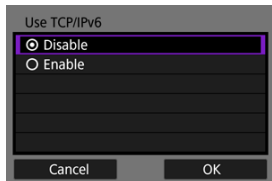

- Select [OK].

17. Press <  >.

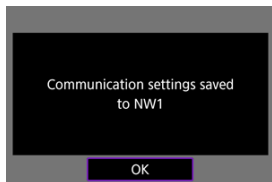

18. Select [New settings].

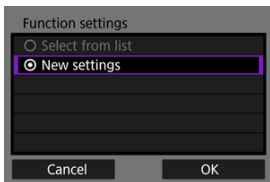

- Select [OK].

For details on subsequent operations, see [Configuring EOS Utility Connection Settings](#).

Terminating Wi-Fi connections (🔗)

Reconnecting (🔗)

Basic Communication Settings

- [Preparation](#)
- [Displaying the Connection Wizard](#)
- [Checking the Type of Access Point](#)
- [Connecting via WPS \(PBC Mode\)](#)
- [Connecting via WPS \(PIN Mode\)](#)
- [Connecting Manually to Detected Networks](#)
- [Connecting Manually by Specifying Networks](#)
- [Connecting in Infrastructure Mode](#)
- [Connecting in Camera Access Point Mode](#)
- [Setting the IP Address](#)
- [Configuring Communication Function Settings](#)

Before using the following camera communication functions, configure camera and computer settings as described starting in [Preparation](#).

- Image transfer to FTP servers
- Remote control (EOS Utility)
- Controlling the camera with Browser Remote

Caution

- Regarding settings for multiple networks, only infrastructure settings are available when you connect wirelessly. Multiple network settings are not available for wired LAN or camera access point settings.

Preparing to use communication functions

● EOS Utility

A computer with EOS Utility (EOS software) installed is required.
For EOS Utility installation instructions, visit the Canon website.

● FTP transfer

A computer running one of the following OSes is required. The computer must also be set up in advance to function as an FTP server.

- **Windows 10 (ver. 1607 or later)**
- **Windows 8.1, Windows 8.1 Pro**

For instructions on setting up the computer to function as an FTP server, refer to documentation for your computer.

● Browser Remote

Use of **[Browser Remote]** requires a computer with one of the following browsers installed.

- iOS 13 or later / Safari 13 or later
- iPadOS 13 or later / Safari 13 or later
- Android 8, 9, 10 or later / Chrome
- Windows 10 / Chrome, Edge (Chromium-based version)
- macOS / Safari 13 or later

* Operation in these browsers is not ensured on all computers.

* Cannot be used unless cookies are enabled in the browser.

* Cannot be used unless JavaScript is enabled in the browser.

* Movie playback is not available unless the browser supports HTML5.

● Sync time between cameras

See [Syncing Time Between Cameras](#).

● GPS

See [Setting Up GPS Features](#).

Preparing to connect via Wi-Fi

Connect the computer for the Wi-Fi connection to the access point in advance.

Caution

Transferring movies

- Each movie file is large, and transferring large files over Wi-Fi may take some time. Referring to [Communication Function Precautions](#), arrange your network environment for stable communication between devices and the access point.

Preparing to connect via wired LAN

Before using the following features over a wired LAN connection, connect a LAN cable to the camera's Ethernet RJ-45 terminal and the Ethernet terminal of the computer or access point.

- Image transfer to FTP servers
- Using EOS Utility
- Using Browser Remote

Use a highly shielded Category 5e or higher STP (Shielded Twisted Pair) Gigabit Ethernet cable.

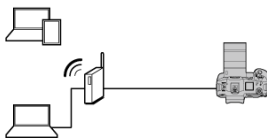
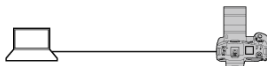
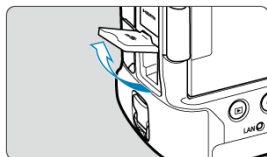

Displaying the Connection Wizard

This section describes the process of following the connection wizard instructions to add connection settings. If an error is displayed, see [Troubleshooting](#) and check the settings.

- Be careful not to press the shutter button or other controls (which will close the connection wizard) until configuration is complete.
- [📶: Network settings] is only available when [📷: Multiple exposure] is set to [Disable].

1. On the camera, press the <MENU> button.

2. Select [📶: Network settings].

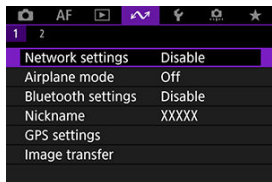

3. In [Network], select [Enable].

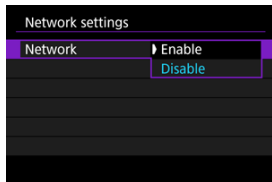

4. Select [Connection settings].

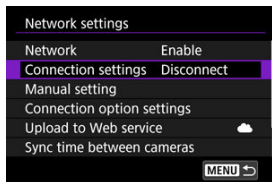

5. Select [SET*].

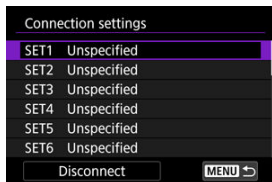

6. Select [Create with wizard].

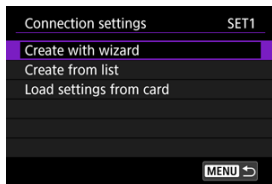

- Selecting [**Create from list**] when multiple communication and function settings are registered on the camera enables you to combine registered settings to add new connection settings.
- You can also add new connection settings by using connection settings saved to a card. Configure settings this way by selecting [**Load settings from card**] (.

7. Select a setting method.

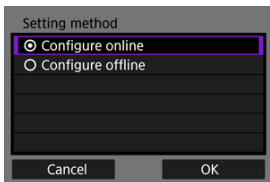

- Select an option and then **[OK]** to go to the next screen.
- Select **[Configure online]** to configure connection settings and then join the network.
- Select **[Configure offline]** if you only wish to configure **[FTP trans.]** and **[Browser Remote]** connection settings.

8. Select a communication function.

[Configure online] options

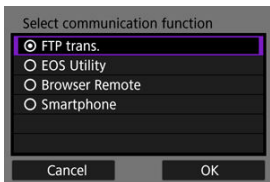

[Configure offline] options

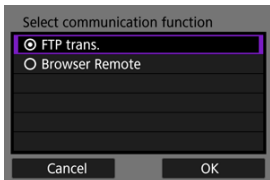

- Referring to [Preparation](#), select a communication function.
- Select an option and then **[OK]** to go to the next screen.

9. Select an option.

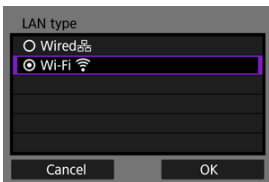

- The options displayed vary depending on the [**Select communication function**] setting.
- Select [**OK**].

10. Select [**New settings**].

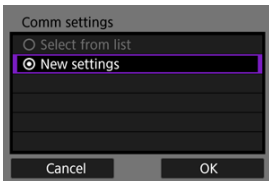

- Select [**OK**].
- By selecting [**Select from list**] when communication settings are already registered on the camera, you can apply the registered settings.

[Configure online] options

If you selected **[Wired]** in step 9, configure the setting as follows.

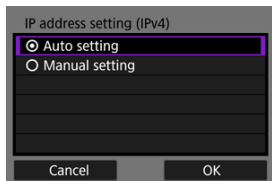

- Select an option, then select **[OK]**.
- For details on IP address settings, see [Setting the IP Address](#).

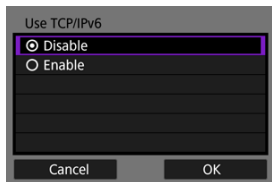

- Select an option, then select **[OK]**.
- For details on IPv6 address settings, see [Setting the IP Address](#).

If you selected **[Wi-Fi]** in step 9, configure the setting as follows.

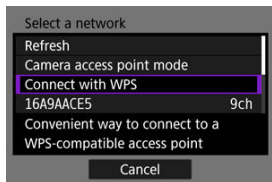

- For details on connections with other devices via an access point, see [Checking the Type of Access Point](#).
- For details on direct connections with other devices, see [Connecting in Camera Access Point Mode](#).

[Configure offline] options

If you selected **[Wired]** in step 9, configure the setting as follows.

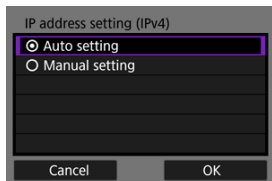

- Select an option, then select **[OK]**.
- For details on IP address settings, see [Setting the IP Address](#).

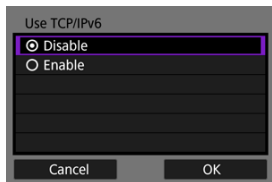

- Select an option, then select **[OK]**.
- For details on IPv6 address settings, see [Setting the IP Address](#).

If you selected **[Wi-Fi]** in step 9, configure the setting as follows.

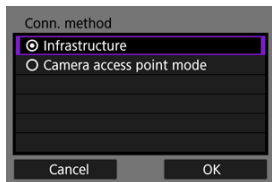

- For details on Wi-Fi connections with other devices via an access point, see [Connecting in Infrastructure Mode](#).
- For details on direct Wi-Fi connections with other devices, see [Connecting in Camera Access Point Mode](#).

Checking the Type of Access Point



When connecting via an access point, check whether the access point supports WPS*, which simplifies connections between Wi-Fi devices.

If you are unsure about WPS compatibility, refer to the access point user manual or other documentation.



* Stands for Wi-Fi Protected Setup.

● When WPS is supported

Two connection methods are available, as follows. You can connect more easily via WPS in PBC mode.

- Connecting via WPS (PBC Mode) 
- Connecting via WPS (PIN Mode) 

● When WPS is not supported

- Connecting manually to detected networks 
- Connecting manually by specifying networks 

Access point encryption

The camera supports the following options for **[Authentication]** and **[Encryption settings]**. For this reason, the encryption used by the access point must be set to one of the following when you will connect to detected networks manually.

- **[Authentication]:** Open system, shared key, WPA/WPA2/WPA3-Personal, or WPA/WPA2/WPA3-Enterprise
- **[Encryption settings]:** WEP, TKIP, or AES

Caution

- **Connections may not be possible when access point stealth functions are enabled. Deactivate stealth functions.**
- Ask any network administrator in charge of networks you will join for setting details.

Note

- If MAC address filtering is used on networks you will join, add the camera's MAC address to the access point. The MAC address can be checked on the **[MAC address]** screen .

Connecting via WPS (PBC Mode)

Instructions in this section are continued from [Checking the Type of Access Point](#).

This is a connection method used with access points compatible with WPS. In pushbutton connection mode (PBC mode), the camera and access point can be connected simply by pressing the WPS button on the access point.

- Connecting may be more difficult if multiple access points are active nearby. If so, try to connect with **[WPS (PIN mode)]**.
- Check the position of the WPS button on the access point in advance.
- It may take approx. 1 min. to establish a connection.

1. Select **[Connect with WPS]**.

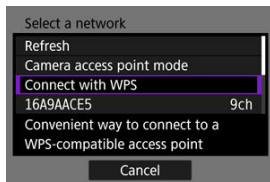

2. Select **[WPS (PBC mode)]**.

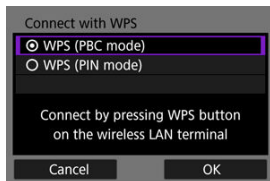

- Select **[OK]**.

3. Connect to the access point.

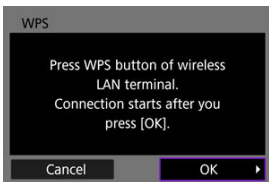

- Press the access point's WPS button. For details on where the button is and how long to press it, refer to the access point user manual.
- Select **[OK]** to initiate connection with the access point.
- The following screen is displayed once the camera is connected to the access point.

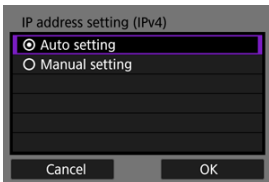

Go to [Setting the IP Address.](#)

Connecting via WPS (PIN Mode)

Instructions in this section are continued from [Checking the Type of Access Point](#).

This is a connection method used with access points compatible with WPS. In PIN code connection mode (PIN mode), an 8-digit identification number indicated on the camera is entered on the access point to establish a connection.

- Even if multiple access points are active nearby, connecting by using this shared identification number is relatively reliable.
- It may take approx. 1 min. to establish a connection.

1. Select [Connect with WPS].

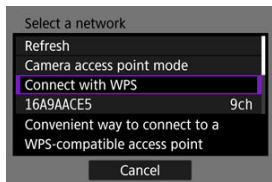

2. Select [WPS (PIN mode)].

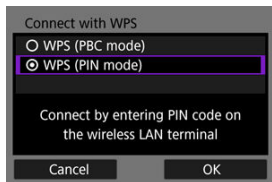

- Select [OK].

3. Enter the PIN code.

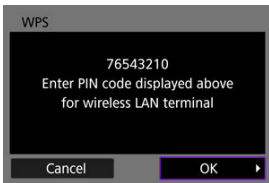

- On the access point, enter the 8-digit PIN code displayed on the camera screen.
- For instructions on entering PIN codes on the access point, refer to the access point's Instruction Manual.
- After entering the PIN code, select **[OK]** on the camera.

4. Connect to the access point.

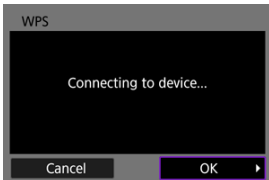

- Select **[OK]** to initiate connection with the access point.
- The following screen is displayed once the camera is connected to the access point.

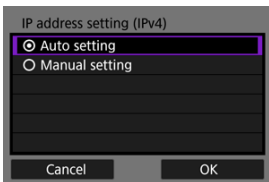

Go to [Setting the IP Address](#).

Connecting Manually to Detected Networks

Instructions in this section are continued from [Checking the Type of Access Point](#). Connect to an access point by selecting its SSID (or ESS-ID) in a list of active access points nearby.

Selecting the access point

1. Select an access point.

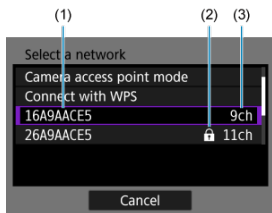

(1) SSID

(2) Security icon (only for encrypted access points)

(3) Channel used

- Turn the dial to select the access point to connect to in the list of access points.

Note

[Refresh]

- To display [Refresh], scroll down the screen in step 1.
- Select [Refresh] to search for access points again.

Entering the access point encryption key

- Enter the encryption key (password) set on the access point. For details on the encryption key that has been set, refer to the access point's user manual.
- The screens displayed in steps 2–3 vary depending on the authentication and encryption set on the access point.
- Go to [Setting the IP Address](#) if the [IP address set.] screen is displayed instead of the screens shown for steps 2–3.

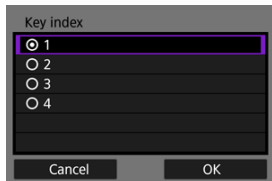

2. Select a key index.

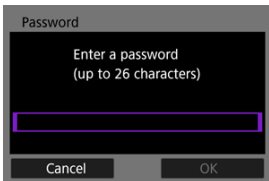

- The [**Key index**] screen is displayed for WEP-encrypted access points.
- Select the key index number set on the access point.
- Select [**OK**].

3. Enter the encryption key.



- Press <  > to access the virtual keyboard (), then enter the encryption key.
- Select [**OK**] to initiate connection with the access point.
- The following screen is displayed once the camera is connected to the access point.

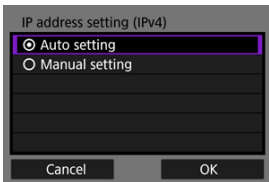

Go to [Setting the IP Address](#).

Connecting Manually by Specifying Networks

Instructions in this section are continued from [Checking the Type of Access Point](#). Connect to an access point by entering its SSID (or ESS-ID).

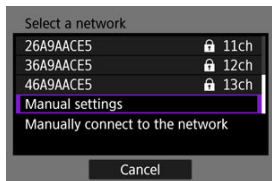

Entering the SSID

1. Select [Manual settings].

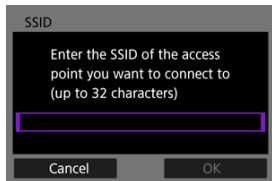

2. Enter the SSID (network name).



- Press <  > to access the virtual keyboard (), then enter the encryption key.
- Select [OK].

3. Select the authentication method.

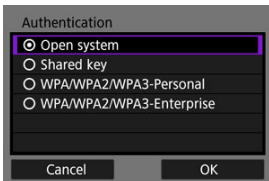

- Select an option and then **[OK]** to go to the next screen.
- On the **[Encryption settings]** screen displayed if **[Open system]** is selected, select **[Disable]** or **[WEP]**.

Entering the access point encryption key

- Enter the encryption key (password) set on the access point. For details on the password that has been set, refer to the access point's user manual.
- The screens displayed in steps 4–5 vary depending on the authentication and encryption set on the access point.
- Go to [Setting the IP Address](#) if the **[IP address set.]** screen is displayed instead of the screens shown for steps 4–5.

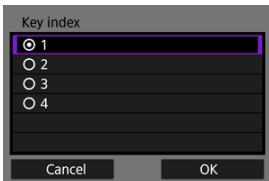

4. Select a key index.

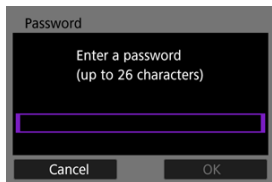

- The **[Key index]** screen is displayed if you have selected **[Shared Key]** or **[WEP]** in step 3.
- Select the key index number set on the access point.
- Select **[OK]**.

5. Enter the encryption key.



- Press <  > to access the virtual keyboard (), then enter the encryption key.
- Select [**OK**] to initiate connection with the access point.
- The following screen is displayed once the camera is connected to the access point.

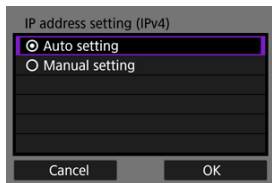

Go to [Setting the IP Address](#).

Connecting in Infrastructure Mode

Instructions in this section are continued from [Displaying the Connection Wizard](#). Connect to an access point by entering its SSID (or ESS-ID).

Entering the SSID

1. Select [Infrastructure].

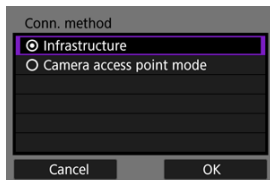

- Select [OK].

2. Enter the SSID (network name).

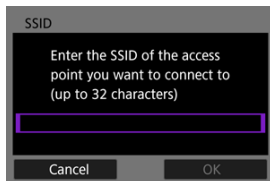

- Press <SET> to access the virtual keyboard (☑), then enter the encryption key.
- Select [OK].

3. Select the authentication method.

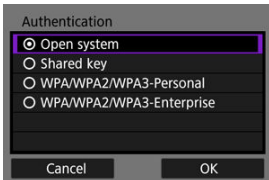

- Select an option and then **[OK]** to go to the next screen.
- On the **[Encryption settings]** screen displayed if **[Open system]** is selected, select **[Disable]** or **[WEP]**.

Entering the access point encryption key

- Enter the encryption key (password) set on the access point. For details on the password that has been set, refer to the access point's user manual.
- The screens displayed in steps 4–5 vary depending on the authentication and encryption set on the access point.
- Go to [Setting the IP Address](#) if the **[IP address set.]** screen is displayed instead of the screens shown for steps 4–5.

4. Select a key index.

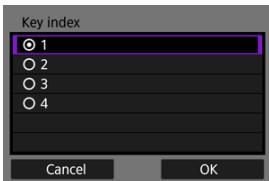

- The **[Key index]** screen is displayed if you have selected **[Shared Key]** or **[WEP]** in step 3.
- Select the key index number set on the access point.
- Select **[OK]**.

5. Enter the encryption key.

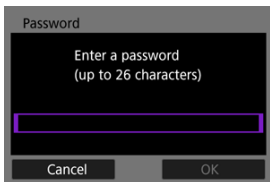

- Press < **SET** > to access the virtual keyboard (), then enter the encryption key.
- Select [**OK**] to initiate connection with the access point.
- The following screen is displayed once the camera is connected to the access point.

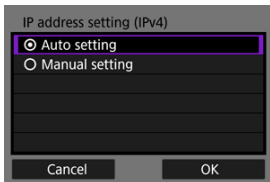

Go to [Setting the IP Address.](#)

Connecting in Camera Access Point Mode

Instructions in this section are continued from [Displaying the Connection Wizard](#). Camera access point mode is a connection method for directly connecting the camera and other devices via Wi-Fi without using an access point. Two connection methods are available, as follows.

Connecting with Easy connection

Network settings for camera access point mode are configured automatically.

- Establishing a connection also requires operations on the other device (computer or smartphone). For details, refer to the device user manual.

1. Select [Camera access point mode].

[Configure online] options

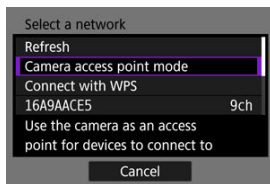

[Configure offline] options

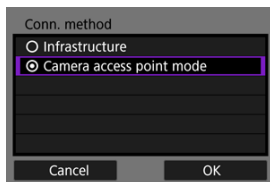

- Select [OK] on the [Conn. method] to go to the next screen.

2. Select [Easy connection].

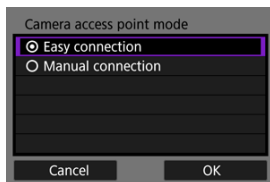

- Select [OK].

3. Select [OK].

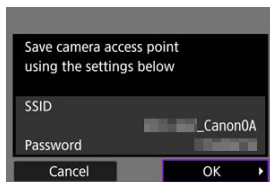

- The next screen is displayed.

4. Select [OK].

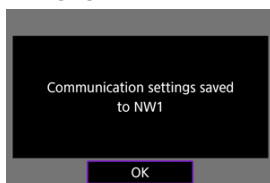

- The next screen is displayed.

5. Select [New settings].

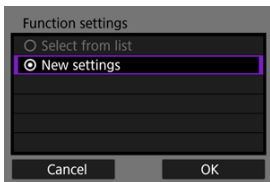

- Select [OK].
- For [Configure online], go to step 6.
- For [Configure offline], go to step 2 in [Configuring Communication Function Settings](#).
- By selecting [Select from list] when communication function settings are already registered on the camera, you can apply the registered settings.

6. Use the other device to connect to the camera.

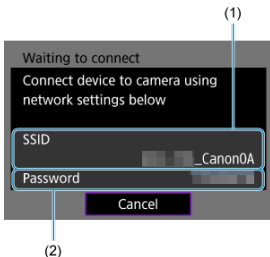

(1) SSID (network name)

(2) Encryption key (password)

Computer's screen (sample)

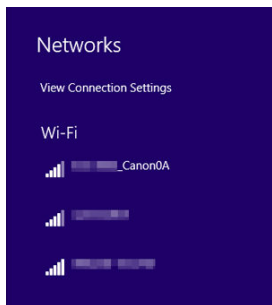

Smartphone's screen (sample)

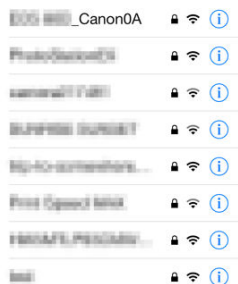

- Activate Wi-Fi on the other device, then select the SSID (network name) shown on the camera screen.
- For the password, enter the encryption key (password) shown on the camera screen.
- Once a connection is established, the settings screen for the communication function is displayed.

Go to step 2 in [Configuring Communication Function Settings](#).

Note

- When you are connecting by selecting [**Easy connection**], the SSID ends with “_Canon0A.”

Connecting with Manual connection

Network settings for camera access point mode are configured manually. Set **[SSID]**, **[Channel setting]**, and **[Encryption settings]** on each screen displayed.

1. Select **[Manual connection]**.

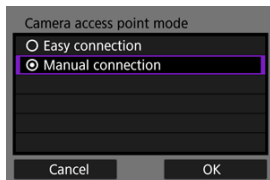

- Select **[OK]**.

2. Enter the SSID (network name).

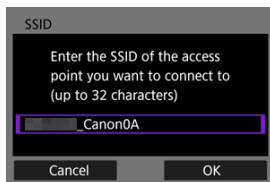

- Press **<SET>** to access the virtual keyboard (📄), then enter the SSID. After input, press **<MENU>**.
- Select **[OK]**.

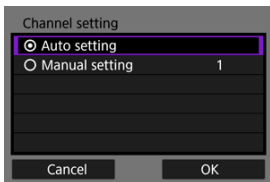

3. Select a channel setting option.

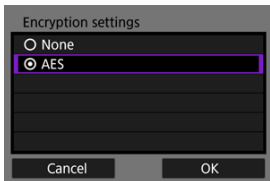

- To specify the settings manually, select [**Manual setting**], then turn the <  > dial.
- Select [**OK**].

4. Select an encryption setting option.



- For encryption, select [**AES**].
- Select [**OK**].
- When [**AES**] is selected, the [**Password**] screen is displayed. Press <  > to access the virtual keyboard (), then enter the encryption key. After input, press the < **MENU** > button.

5. Select [Auto setting].

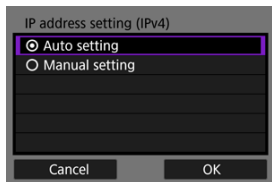

- Select [OK].
- If an error is displayed for [Auto setting], set the IP address manually (🔗).

6. Select [OK].

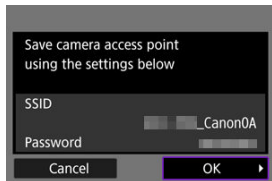

- The next screen is displayed.

7. Select [OK].

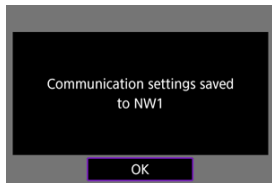

- The next screen is displayed.

8. Select [New settings].

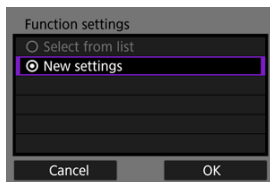

- Select [OK].
- For [Configure online], go to step 9.
- For [Configure offline], go to step 2 in [Configuring Communication Function Settings](#).
- By selecting [Select from list] when communication function settings are already registered on the camera, you can apply the registered settings.

9. Use the other device to connect to the camera.

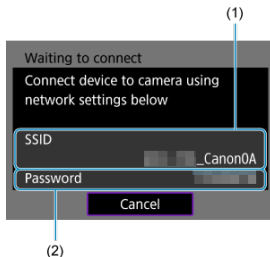

(1) SSID (network name)

(2) Encryption key (password)

Computer's screen (sample)

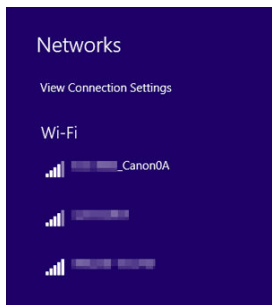

Smartphone's screen (sample)

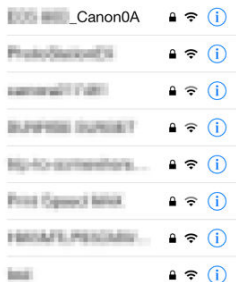

- Activate Wi-Fi on the other device, then select the SSID (network name) shown on the camera screen.
- For the password, enter the encryption key (password) shown on the camera screen.
- Once a connection is established, the settings screen for the communication function is displayed.

Go to step 2 in [Configuring Communication Function Settings](#).

Setting the IP Address

Select a method of setting the IP address, and then set the IP address on the camera. When IPv6 is used, the camera only connects via IPv6. IPv4 connections are disabled.

Setting the IP address automatically

Set up the IP address settings automatically.

1. Select [Auto setting].

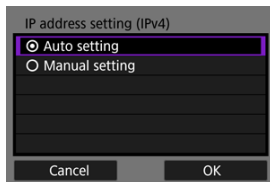

- Select [OK].
- If an error is displayed for [Auto setting], set the IP address manually (🔗).

2. Select an IPv6 option.

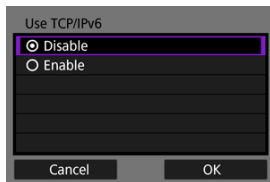

- Select an option and then [OK] to go to the next screen.
- When selecting [Enable], configure IPv6 settings after all settings are complete (🔗).
- The next screen is displayed after settings are complete.

3. Select [OK].

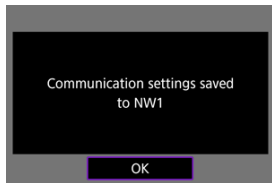

- The next screen is displayed.

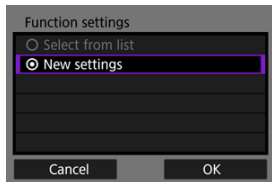

Go to [Configuring Communication Function Settings](#).

Setting the IP address manually

Set up the IP address settings manually. Note that the items displayed vary depending on the communication function.

1. Select [Manual setting].

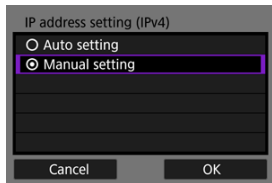

- Select [OK].

2. Select an option to configure.

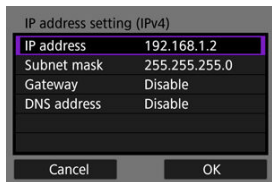

IP address setting (IPv4)

IP address	192.168.1.2
Subnet mask	255.255.255.0
Gateway	Disable
DNS address	Disable

Cancel OK

- Select an option to access the screen for numerical input.
- To use a gateway or DNS address, select [**Enable**], then select [**Address**].

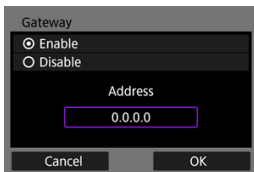

Gateway

Enable
 Disable

Address

0.0.0.0

Cancel OK

3. Enter the number.





IP address SET1

192 . 168 . 1 . 2

0 1 2 3 4 5 6 7 8 9

INFO Cancel MENU OK

- Turn the <  > dial to switch to other input fields at the top of the screen, and turn the <  > dial to select numbers to enter. Press <  > to enter the selected number.
- To set the entered numbers and return to the screen for step 2, press the < **MENU** > button.

4. Select [OK].

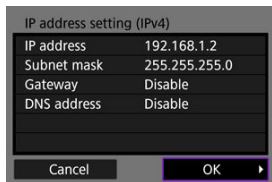

- When you have completed setting the necessary items, select [OK]. The next screen is displayed.
- If you are unsure what to enter, see [Checking Network Settings](#) or ask the network administrator or other person in charge of the network.

5. Select an IPv6 option.

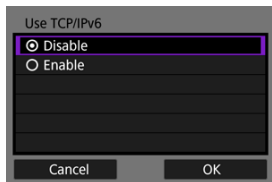

- Select an option and then [OK] to go to the next screen.
- When selecting [Enable], configure IPv6 settings after all settings are complete ([?/](#)).
- The next screen is displayed after settings are complete.

6. Select [OK].

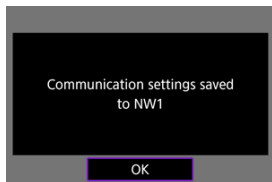

- The next screen is displayed.

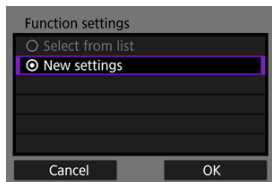

Go to [Configuring Communication Function Settings](#).

Configuring Communication Function Settings

The following instructions are for settings that vary depending on the communication function. Refer to the page that introduces your selected communication function.

1. Select [New settings].

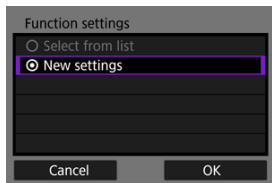

- Select [**OK**] to go to the next screen.
- By selecting [**Select from list**] when communication function settings are already registered on the camera, you can apply the registered settings.

2. Complete connection settings for the communication function.

FTP transfer (🔗)

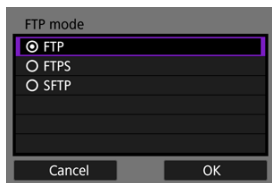

EOS Utility (🔗)

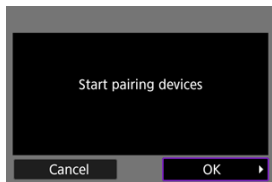

Browser Remote (🔗)

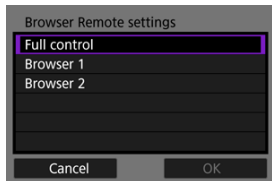

Image Transfer to FTP Servers

- [✔ Configuring FTP Server Connection Settings](#)
- [✔ Transferring Images Individually](#)
- [✔ Transferring Multiple Images at Once](#)
- [✔ Adding a Caption Before Transfer](#)
- [✔ Auto Retry If Transfer Fails](#)
- [✔ Viewing Transferred Images](#)
- [✔ Transferring Images with Mobile File Transfer](#)

By connecting to an FTP server, you can send images on the camera to a computer. With FTP transfer, you can automatically transfer each image to the FTP server as you shoot or transfer a set of images together.



Note

- JPEG/HEIF images can be resized or cropped during the transfer process.

Configuring FTP Server Connection Settings

These instructions are continued from [Configuring Communication Function Settings](#).

1. Select an FTP mode.

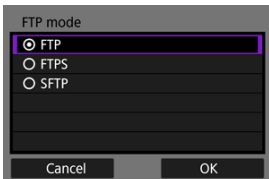

- [SFTP] is not displayed when the camera will connect via Wi-Fi.
- For secure FTP transfer using a root certificate, select [FTPS]. For details on root certificate settings, see [Importing a root certificate for FTPS](#).
- For secure FTP transfer over an SSH connection, select [SFTP]. Login settings are configured in step 5.
- Select [OK] to go to the next screen.

2. Select [Address setting].

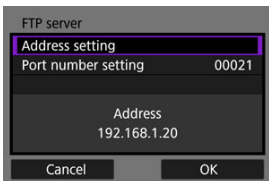

- The virtual keyboard is displayed if you have specified [Auto setting] for the IP address or [Manual setting] for the DNS address.
- A screen for numerical input is displayed if you have specified [Disable] for the DNS address.
- Select [OK] to go to the next screen.

3. Enter the FTP server IP address.

Virtual keyboard

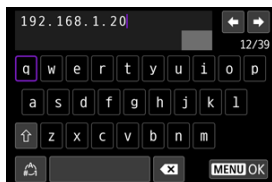

- Use the virtual keyboard (🖱️) to enter the IP address. If DNS is used, enter the domain name.
- To set the entered values and return to the screen for step 2, press the < MENU > button.

Numerical input screen

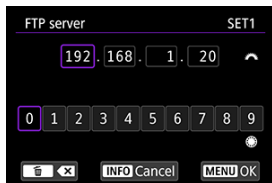

- Turn the < 🔄 > dial to switch to other input fields at the top of the screen, and turn the < 🕒 > dial to select numbers to enter. Press < SET > to enter the selected number.
- To set the entered values and return to the screen for step 2, press the < MENU > button.

4. Configure the port number.

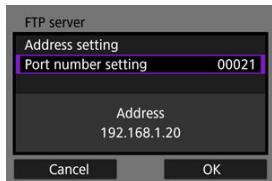

- Normally, set [**Port number setting**] to 00021 (for FTP/FTPS) or 00022 (for SFTP).
- Select [**OK**] to go to the next screen.
- Go to step 6 if you selected [**FTP**] or [**FTPS**] in step 1. Go to step 5 if you selected [**SFTP**].

5. Configure the SSH login authentication settings.

SSH login settings

User name	
Password	*****

Cancel OK

- Select [**User name**] and [**Password**] to access the virtual keyboard () and enter the user name and password for SSH password authentication.
- Select [**OK**] to go to the next screen.

6. Configure the passive mode setting.

Passive mode

Enable
 Disable

Cancel OK

- Not displayed if you selected [**SFTP**] in step 1.
- Select [**OK**] to go to the next screen.
- If an Error 41 (Cannot connect to FTP server) is displayed in step 9, setting [**Passive mode**] to [**Enable**] may resolve it.

7. Configure proxy server settings.

Proxy server

Proxy server	Disable
Address setting	
Port number setting	10021
Address	0.0.0.0

Cancel OK

- Not displayed if you selected [**FTPS**] or [**SFTP**] in step 1.
- Select [**OK**] to go to the next screen.

8. Configure the login method.

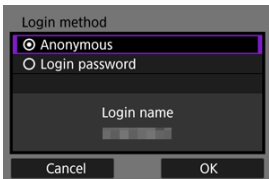

- Not displayed if you selected [SFTP] in step 1.
- Select [OK] to go to the next screen.

9. Specify a target folder.

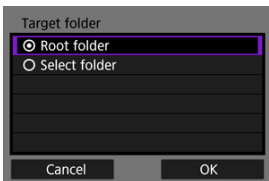

- Select [**Root folder**] to have images saved in the root folder, as specified in FTP server settings (🔗).
- Select [**Select folder**] to specify a target folder in the root folder. If the folder does not exist, it is created automatically.
- Select [OK] to go to the next screen.
- The camera's <LAN> lamp is lit in green.
- When the following message appears, select [OK] to trust the target server.



10. Select [OK].

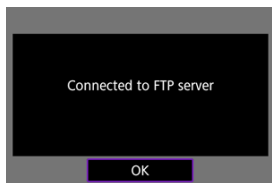

- Not displayed in offline configuration.

11. Select [OK].

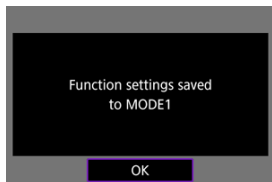

12. Select [OK].

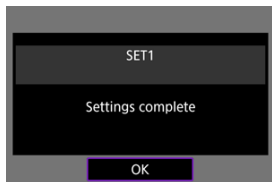

- Display returns to the [Network settings] screen.

Connection settings for FTP transfer are now complete.
During image transfer, the camera's <LAN> lamp blinks in green.

Importing a root certificate for FTPS

If you specified [FTPS] FTP mode when configuring connection settings, the root certificate used by the FTP server must be imported to the camera.

- Only the root certificate with a file name of "ROOT.CER," "ROOT.CRT," or "ROOT.PEM" can be imported to the camera.
- Only one root certificate file can be imported to the camera. Insert a card containing the root certificate file in advance.
- The priority card selected for [Record/play] or [Playback] in [☛: Record func+card/ folder sel.] is used to import a certificate.
- It may not be possible to trust servers you try to connect to in FTPS connections with a self-signed certificate.

1. Select [☛: Network settings].

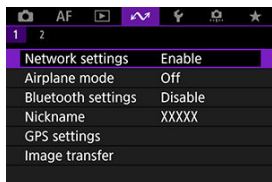

2. Select [Connection option settings].

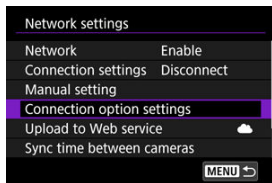

3. Select [FTP transfer settings].

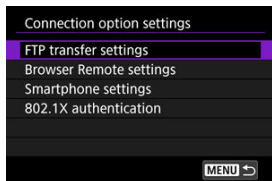

4. Select [Set root certif].

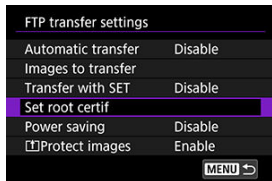

5. Select [Load root certif from card].

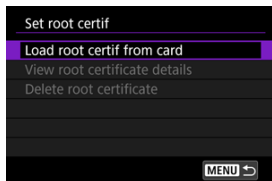

6. Select [OK].



- The root certificate is imported.
- Select [OK] on the confirmation screen to return to the [Set root certif] screen.

 **Note**

- To delete the root certificate imported to the camera, select [**Delete root certificate**] on the screen in step 5. To check who it was issued to and issued by, the period of validity, and other information, select [**View root certificate details**].

Transferring Images Individually

- [Automatic transfer after each shot](#)
- [Transferring the current image](#)
- [Specifying sizes or types of images to transfer](#)

Automatic transfer after each shot

Each image can be immediately transferred to the FTP server automatically after your shot. You can continue shooting still photos as usual while images are being transferred.

- JPEG/HEIF images can be resized or cropped during the transfer process.
- Before shooting, make sure a card is in the camera. If you shoot without recording images, they cannot be transferred.
- Automatic transfer of movies during recording is not supported. After recording, transfer movies as described in [Transferring Multiple Images at Once](#) or [Adding a Caption Before Transfer](#).

1. Select [: Network settings].

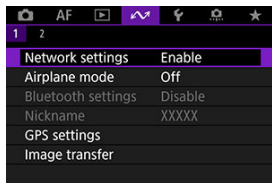

2. Select [Connection option settings].

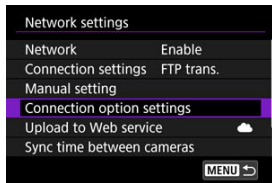

3. Select [FTP transfer settings].

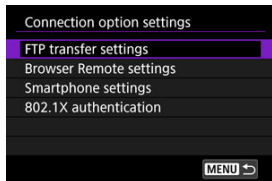

4. Select [Automatic transfer].

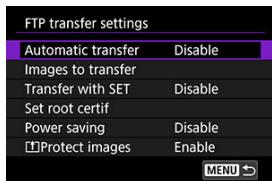

5. Select [Enable].

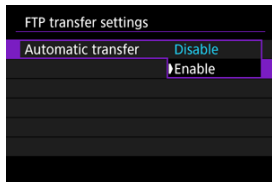

6. Take the picture.

- The captured image is transferred to the FTP server.

 Caution

- Images cannot be erased during image transfer.
- No voice memo can be added when [Automatic transfer] is set to [Enable].

 **Note**

- During continuous shooting, images are transferred to the FTP server in the order they are captured.
- Captured images are also stored on the card.
- Any images for which transfer fails or is interrupted will be transferred automatically when the connection is recovered (🔄). These images can also be transferred together manually at a later time (🔄).
- Repeated automatic transfer is not attempted if network settings (such as FTP server settings) are changed before automatic FTP transfer begins.

Transferring the current image

Enables you to transfer the image you are viewing simply by pressing <  >. You can continue shooting still photos as usual while images are being transferred.

1. Access the [FTP transfer settings] screen.

- Follow steps 1–3 in [Automatic transfer after each shot](#).

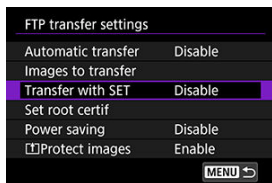

2. Select [Transfer with SET].

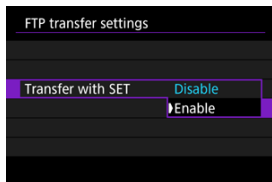

3. Select [Enable].



4. Select an image.

- On the camera, press the <  > button.
- Select an image to transfer, then press <  > to transfer the image.
- You can add a voice memo to the current image before transfer. For details, see [Recording Voice Memos](#).
- Movies cannot be transferred this way. Selecting a movie and pressing <  > will display the movie playback panel.

Specifying sizes or types of images to transfer

You can specify which images to transfer when recording images of different sizes to both cards, or when shooting RAW+JPEG or RAW+HEIF images.

1. Access the [FTP transfer settings] screen.

- Follow steps 1–3 in [Automatic transfer after each shot](#).

2. Select [Images to transfer].

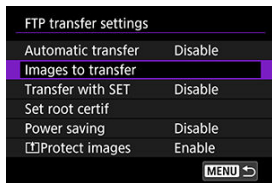

3. Select the size of images to transfer.

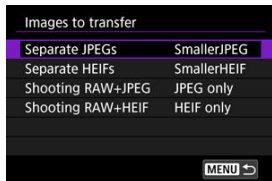

- Select [**Separate JPEGs**] or [**Separate HEIFs**], then choose the image size.

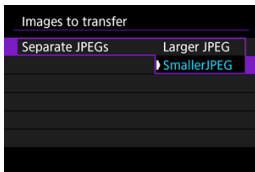

- To transfer smaller JPEG/HEIF images when the camera is set to record larger JPEG/HEIF images to one card and smaller ones to the other, set [**Separate JPEGs**] to [**SmallerJPEG**] or [**Separate HEIFs**] to [**SmallerHEIF**].

4. Select the type of images to transfer.

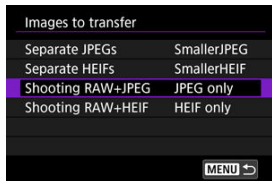

● Shooting RAW+JPEG

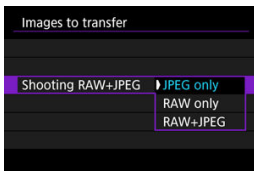

- Select **[Shooting RAW+JPEG]**, then select **[JPEG only]**, **[RAW only]**, or **[RAW+JPEG]**.

● Shooting RAW+HEIF

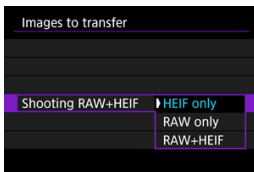

- Select **[Shooting RAW+HEIF]**, then select **[HEIF only]**, **[RAW only]**, or **[RAW+HEIF]**.



Note

- When the camera is set to record RAW images to one card and JPEGs or HEIFs to the other, specify which images to transfer in the [**Shooting RAW+JPEG**] or [**Shooting RAW+HEIF**] setting. Similarly, specify your transfer preference when RAW+JPEG images or RAW+HEIF images are simultaneously recorded to a single card.
- Captured images are also stored on the card.
- When images of the same size are recorded to both cards simultaneously, images recorded to the card selected for [**Record/play**] or [**Play**] in [: **Record func+card/folder sel.**] are given priority for transfer.

Transferring Multiple Images at Once

- ✔ [Selecting images to transfer](#)
- ✔ [Selecting multiple images](#)
- ✔ [Transferring RAW+JPEG or RAW+HEIF images](#)

After shooting, you can select multiple images and transfer them all at once, or you can transfer unsent images or images that could not be sent previously. You can continue shooting still photos as usual during transfer.

⚠ Caution

- Image transfer in progress is paused while the still photo shooting/movie recording switch is set to < >. To resume image transfer, set it to < >.
 - If you will transfer many images, consider using a household power outlet accessory (sold separately).
- JPEG/HEIF images can be resized or cropped during the transfer process.

Selecting images to transfer

1. Select [: Image transfer].

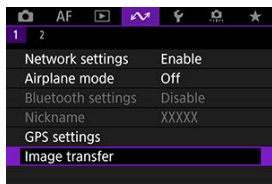

2. Select [Image sel./transfer].

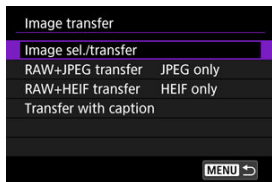

3. Select [FTP transfer].





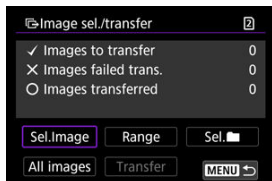



4. Select [Sel.Image].



5. Select the images to transfer.



- Use the <  > dial to select an image to transfer, then press <  >.
- Use the <  > dial to add a checkmark [✓] in the upper left of the screen, then press <  >.
- For three-image display, press the <  > button and turn the <  > dial left. To return to single-image display, turn the <  > dial clockwise.
- To select other images to transfer, repeat step 5.
- After image selection, press the < **MENU** > button.

6. Select [Transfer].



7. Select [OK].

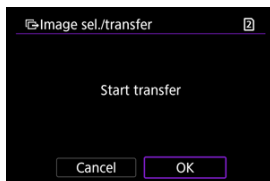

- The selected images are transferred to the FTP server.

Selecting multiple images

Multiple images can be transferred at once after you choose a selection method. You can continue shooting still photos as usual while images are being transferred.

1. Access the [Image sel./transfer] screen.

- Follow steps 1–3 in [Selecting images to transfer](#).

2. Select a selection method.



In a folder

- Select [Sel. **■**].
- Select your preferred selection method.

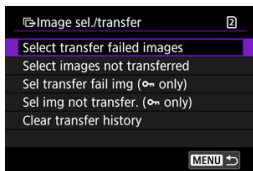

- Selecting [**Select transfer failed images**] selects all images in the selected folder for which transfer failed.
 - Selecting [**Select images not transferred**] selects all unsent images in the selected folder.
 - Selecting [**Sel transfer fail img (On only)**] selects all protected images in the selected folder for which transfer failed.
 - Selecting [**Sel img not transfer. (On only)**] selects all unsent protected images in the selected folder.
 - Selecting [**Clear transfer history**] clears the transfer history of images in the selected folder.
 - After clearing the transfer history, you can select [**Select images not transferred**] and transfer all images in the folder again.
 - After clearing the transfer history, you can select [**Sel img not transfer. (On only)**] and transfer all protected images in the folder again.
- Select a folder.

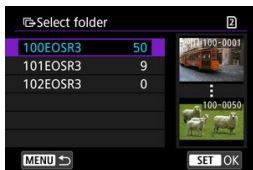

- Select **[OK]** to register the selected images to **[Images to transfer]**.



In a card

- Select **[All images]**.
- Select your preferred selection method.

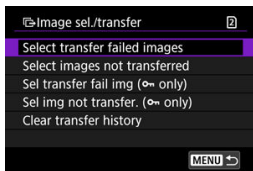

- Selecting **[Select transfer failed images]** selects all images on the card for which transfer failed.
 - Selecting **[Select images not transferred]** selects all unsent images on the card.
 - Selecting **[Sel transfer fail img (o-n only)]** selects all protected images on the card for which transfer failed.
 - Selecting **[Sel img not transfer. (o-n only)]** selects all unsent protected images on the card.
 - Selecting **[Clear transfer history]** clears the transfer history of images on the card.
 - After clearing the transfer history, you can select **[Select images not transferred]** and transfer all images recorded on the card again.
 - After clearing the transfer history, you can select **[Sel img not transfer. (o-n only)]** and transfer all protected images recorded on the card again.
- Select **[OK]** to register the selected images to **[Images to transfer]**.



Select range

- Select [**Range**].
- Selecting the first and last images of the range marks all the images in the range with a checkmark [✓], and one copy of each image will be sent.
- After image selection, press the < **MENU** > button.

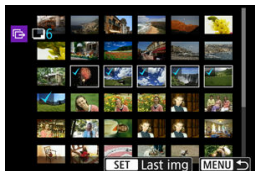

Transferring RAW+JPEG or RAW+HEIF images

For RAW+JPEG or RAW+HEIF images, you can specify which image to transfer.

1. Select [M: Image transfer].

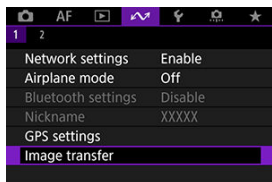

2. Select the type of images to transfer.

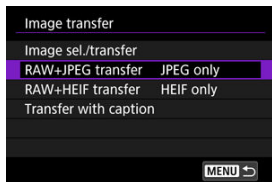

- **RAW+JPEG transfer**

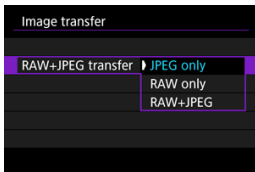

- Select [**RAW+JPEG transfer**], then select [**JPEG only**], [**RAW only**], or [**RAW+JPEG**].

- **RAW+HEIF transfer**

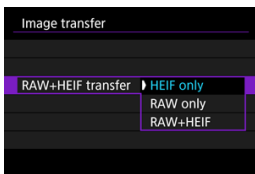

- Select [**RAW+HEIF transfer**], then select [**HEIF only**], [**RAW only**], or [**RAW+HEIF**].

 **Caution**

- Some menu items are not available during image transfer.

 **Note**

- This setting is linked to [**RAW+JPEG transfer**] and [**RAW+HEIF transfer**] settings on the [**Images to transfer**] screen ().

Adding a Caption Before Transfer

You can add a registered caption to each image before transfer. This is convenient if you want to inform the recipient of the printing quantity, for example. Captions are also added to images saved to the camera.

- You can check captions added to images by examining the Exif information, in the user comments.
- Captions can be created and registered with EOS Utility (🔗) or Browser Remote (🔗).

1. Select [M: Image transfer].

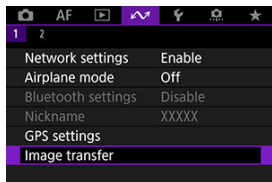

2. Select [Transfer with caption].

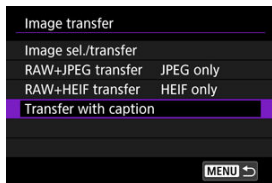

- The last image viewed is displayed.

3. Specify the caption.

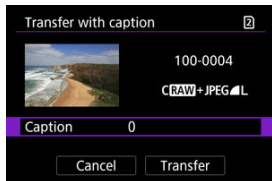

- Select [**Caption**], and on the screen displayed, select the content of the caption.

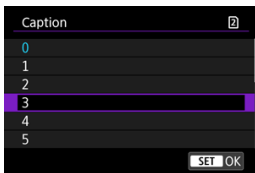

4. Select [**Transfer**].

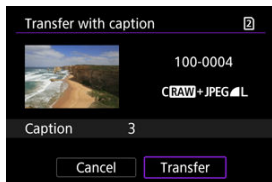

- The image is transferred with the caption. After transfer, display returns to the [**Image transfer**] screen.

Caution

- Other images cannot be selected from the [**Transfer with caption**] screen. To select another image for transfer with a caption, view that image before following these steps.



Auto Retry If Transfer Fails

If transfer fails, the camera's <LAN> lamp blinks in red. In this case, the following screen is displayed after you press the <MENU> button and select []: **Network settings**. To resolve the error displayed, see [Troubleshooting](#).



Once you have resolved the issue, the images that could not be sent initially will be transferred automatically. With this option activated, transfer is attempted again automatically after failure, whether automatic transfer is used or captured images are transferred manually via FTP. Note that if you cancel transfer or turn the camera off, auto retry is not attempted. See [Transferring Multiple Images at Once](#) and transfer images as needed.

Note

- To automatically log off and disconnect from the LAN after transfer, you can configure power-saving on the [**FTP transfer settings**] screen (.
- If you prefer not to disconnect from the LAN, set [**Power saving**] on the [**FTP transfer settings**] screen () to [**Disable**].

Viewing Transferred Images

Images transferred to the FTP server are stored in the following folder as specified in the FTP server settings.

Target folder of the FTP server

- Under the default settings of the FTP server, images are stored in [C drive] → [Inetpub] folder → [ftproot] folder, or in a subfolder of this folder.
- If the root folder of the transfer destination has been changed in the FTP server settings, ask the FTP server administrator where images are transferred.

Transferring Images with Mobile File Transfer

Using the Mobile File Transfer smartphone app, you can transfer images from the camera to FTP servers over a mobile network connection.

For software instruction manuals, see [Software](#).

Sending Images to a Web Service

[Registering image.canon and Setting Up Auto Send](#)

This section describes how to send images to image.canon.

Registering image.canon and Setting Up Auto Send

You can register image.canon on the camera and prepare to send your shots automatically.

- A computer or smartphone with a browser and internet connection is required.
- You will need to enter an email address used on your computer or smartphone.
- For instructions on how to use image.canon services and details on countries and regions where it is available, visit the image.canon site (<https://image.canon/>).
- Separate ISP connection and access point fees may apply.

Steps on the camera (1)

1. On the camera, press the <MENU> button.
2. Select [: Network settings].

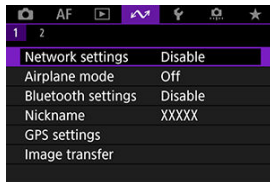

3. In [Network], select [Enable].

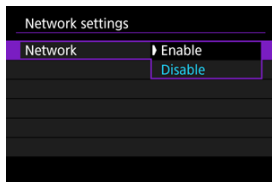

4. Select [Upload to Web service].

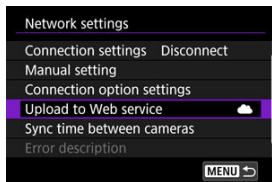

5. Select [I Agree].

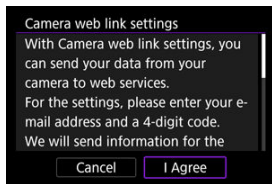

6. Select [New settings].

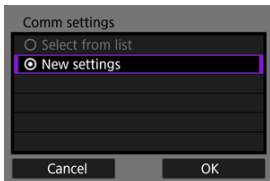

7. Establish a Wi-Fi connection.

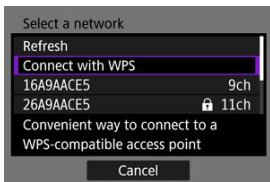

- Connect to an access point via Wi-Fi. Go to [Checking the Type of Access Point](#).

8. Enter your email address.

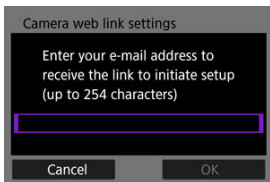

- Enter your email address, then select [OK].

9. Enter a four-digit number.

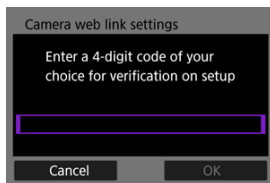

- Enter a four-digit number of your choice, then select [OK].

10. Select [OK].

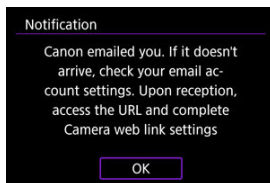

- The [☁] icon changes to [☁➡].

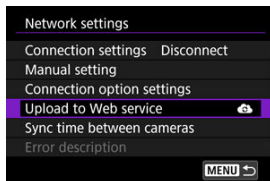

Steps on the computer or smartphone

9. Set up camera web link.

- Access the page in the notification message.
- Follow the instructions to complete the settings on the camera web link settings page.

Steps on the camera (2)

10. Select [Upload to Web service].

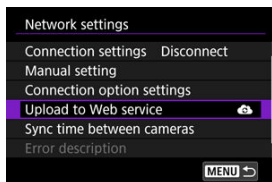

11. Select [OK].

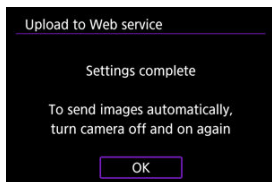

- The [📶] icon changes to [📶].

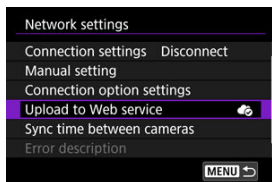

12. Select [Auto send].

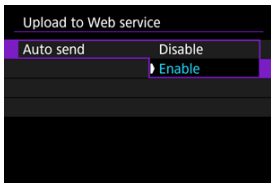

- Once **[Enable]** is set, images are automatically sent when you turn the camera on.

13. Select [Type to send].

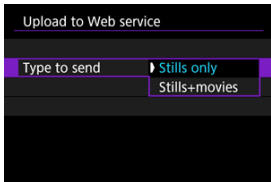

- Set to **[Stills only]** or **[Stills+movies]**.

14. Restart the camera.

- The images are now sent automatically.

- To switch networks, select **[Switch network]** and follow steps 5–8.
- To remove the connection, select **[Clear camera web link settings]** and then **[OK]**.



Note

- All image files on cards are sent when **[Auto send]** is set to **[Enable]**.
- When **[Auto send]** is set to **[Enable]**, auto send starts after the camera starts up (or recovers from auto power off).
- Any images captured during auto sending are also sent.

 **Caution**

- Auto send does not start during interval timer shooting.
- Transfer stops in the following cases.
 - [: **Airplane mode**] is set to [**On**]
 - Movie recording is started
 - A USB connection is started
 - Battery capacity is low
 - The camera's power switch is set to < **OFF** >
- Auto send does not start if you restart the camera while other communication functions are in progress. Before restarting the camera, use [**Connection settings**] to end the connection for other functions.

Remote Control (EOS Utility)

 [Configuring EOS Utility Connection Settings](#)

 [Using EOS Utility](#)

 [Direct Transfer](#)

 [Creating and Registering Captions](#)

Using EOS Utility, you can browse images on the camera and save them to the computer. Also in EOS Utility, you can shoot by controlling the camera remotely and change camera settings.

- Install EOS Utility on the computer before setting up a connection ().
 - See [Wi-Fi Connections with a Computer Using EOS Utility](#) for instructions on preparing for camera operations in EOS Utility by connecting the camera to a computer by joining a Wi-Fi network via an access point compatible with WPS (PBC mode).
-

Configuring EOS Utility Connection Settings

These instructions are continued from [Configuring Communication Function Settings](#).

- Establishing a connection also requires operations on the computer. For details, refer to the computer documentation.

Steps on the camera (1)

1. Select [OK].

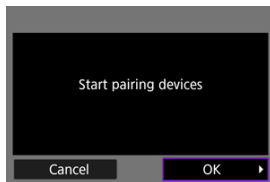

- The following message is displayed.

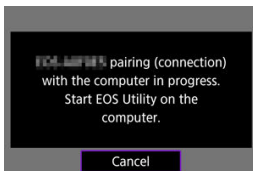

Steps on the computer

2. Start EOS Utility on the computer.
3. In EOS Utility, click [Pairing over Wi-Fi/LAN].

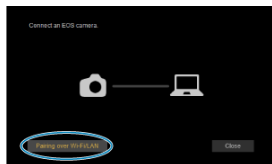

- If a firewall-related message is displayed, select [Yes].

4. Click [Connect] on the computer.

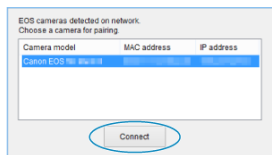

- Select the camera to connect to, then click [Connect].
- If multiple cameras are listed, identify the camera to connect to by MAC address, as shown on the camera screen.
- The camera MAC address can be checked on the [MAC address] screen (🔍).

Steps on the camera (2)

5. Select [OK].

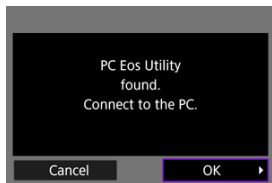

- This message is displayed after the camera detects the computer where you clicked [**Connect**] in step 4.
- Select [**OK**].

6. Select [OK].

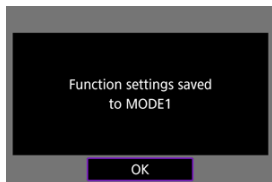

7. Select [OK].

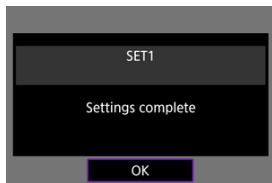

- Display returns to the [**Network settings**] screen.
- The camera's <LAN> lamp is lit in green.
- Setting information is stored on the camera.

Connection settings for EOS Utility are now complete.

- Manually pairing the camera and computer after this is no longer necessary, as long as you do not change the settings after you have paired the devices once.

Using EOS Utility

For EOS Utility instructions, refer to the EOS Utility Instruction Manual. Remote shooting is only one of the many camera operations available.

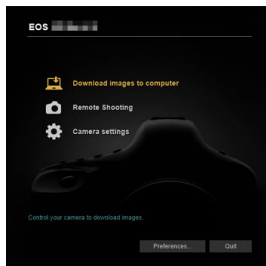

! Caution

- Some menu items are not available when the camera is connected to a network.
- In remote shooting, the AF speed may become slower.
- Depending on the communication status, image display or shutter release timing may be delayed.
- In Remote Live View shooting, the rate of image transmission is slower compared to a connection via an interface cable. Therefore, moving subjects cannot be displayed smoothly.

Direct Transfer

With the camera connected to EOS Utility and the main EOS Utility window displayed, you can use the camera to transfer images to computer.

If you will transfer many images, consider using a household power outlet accessory (sold separately).

Selecting images to transfer

1. Select [: Image transfer].

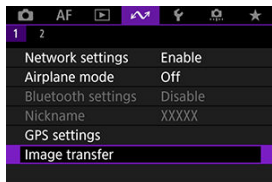

2. Select [Image sel./transfer].

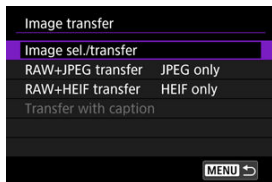

3. Select [Direct transfer].

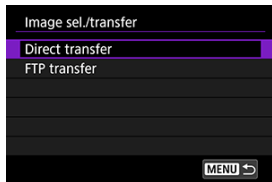



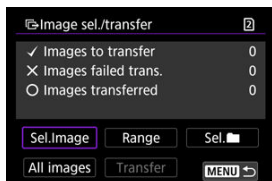



4. Select [Sel.Image].



5. Select an image to transfer.



- Use the <  > dial to select an image to transfer, then press <  >.
- Use the <  > dial to add a checkmark [✓] in the upper left of the screen, then press <  >.
- For three-image display, turn the <  > dial counterclockwise. To return to single-image display, turn the <  > dial clockwise.
- To select other images to transfer, repeat step 5.
- After image selection, press the < **MENU** > button.

6. Select [Transfer].



7. Select [OK].



- The selected images are transferred to the computer.

Selecting multiple images

Multiple images can be transferred at once after you choose a selection method.

1. Access the [Image sel./transfer] screen.

- Follow steps 1–3 in [Selecting images to transfer](#).

2. Select a selection method.



In a folder

- Select [Sel. **■**].
- Select your preferred selection method.

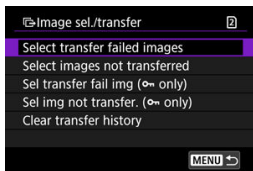

- Selecting [**Select transfer failed images**] selects all images in the selected folder for which transfer failed.
 - Selecting [**Select images not transferred**] selects all unsent images in the selected folder.
 - Selecting [**Sel transfer fail img (P only)**] selects all protected images in the selected folder for which transfer failed.
 - Selecting [**Sel img not transfer. (P only)**] selects all unsent protected images in the selected folder.
 - Selecting [**Clear transfer history**] clears the transfer history of images in the selected folder.
 - After clearing the transfer history, you can select [**Select images not transferred**] and transfer all images in the folder again.
 - After clearing the transfer history, you can select [**Sel img not transfer. (P only)**] and transfer all protected images in the folder again.
- Select a folder.

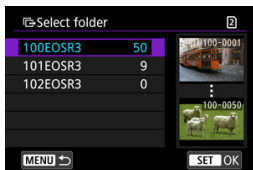

- Select **[OK]** to register to **[Images to transfer]**.



In a card

- Select **[All images]**.
- Select your preferred selection method.

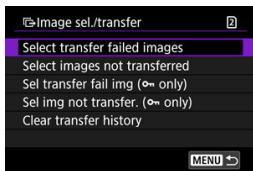

- Selecting **[Select transfer failed images]** selects all images on the card for which transfer failed.
 - Selecting **[Select images not transferred]** selects all unsent images on the card.
 - Selecting **[Sel transfer fail img (o-n only)]** selects all protected images on the card for which transfer failed.
 - Selecting **[Sel img not transfer. (o-n only)]** selects all unsent protected images on the card.
 - Selecting **[Clear transfer history]** clears the transfer history of images on the card.
 - After clearing the transfer history, you can select **[Select images not transferred]** and transfer all images recorded on the card again.
 - After clearing the transfer history, you can select **[Sel img not transfer. (o-n only)]** and transfer all protected images recorded on the card again.
- Select **[OK]** to register the selected images to **[Images to transfer]**.



Select range

- Select **[Range]**.
- Selecting the first and last images of the range marks all the images in the range with a checkmark [✓], and one copy of each image will be sent.
- After image selection, press the < **MENU** > button.

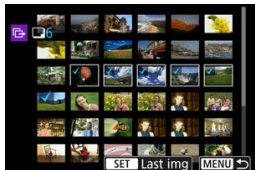

- Select **[OK]** to register the selected images to **[Images to transfer]**.

Transferring RAW+JPEG or RAW+HEIF images

For RAW+JPEG or RAW+HEIF images, you can specify which image to transfer.

1. Select [M: Image transfer].

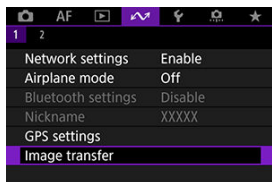

2. Select the type of images to transfer.

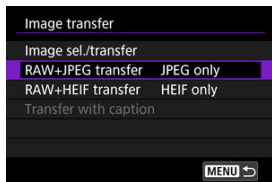

- **RAW+JPEG transfer**

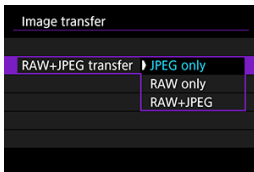

- Select [**RAW+JPEG transfer**], then select [**JPEG only**], [**RAW only**], or [**RAW+JPEG**].

- **RAW+HEIF transfer**

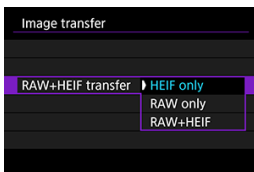

- Select [**RAW+HEIF transfer**], then select [**HEIF only**], [**RAW only**], or [**RAW+HEIF**].

 **Caution**

- Some menu items are not available during image transfer.

 **Note**

- This setting is linked to [**RAW+JPEG transfer**] and [**RAW+HEIF transfer**] settings on the [**Images to transfer**] screen ().

Creating and Registering Captions

You can create captions and register them on the camera to use them as described in [Adding a Caption Before Transfer](#).

1. Start EOS Utility and select [Camera settings].

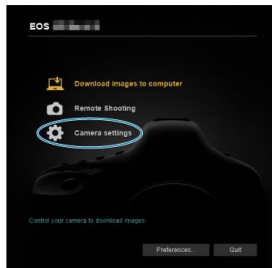

2. Select [WFT Captions].

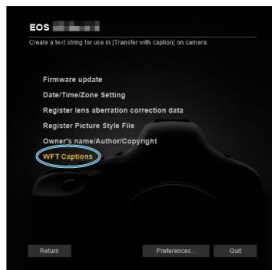

3. Enter the caption or captions.

Register text to use with [Transfer with caption] feature.

1	<input type="text" value="Canon"/>
2	<input type="text" value="1"/>
3	<input type="text" value="2"/>
4	<input type="text" value="3"/>

- Enter up to 31 characters (in ASCII format).
- To acquire caption data stored on the camera, select [Load settings].

4. Set the captions on the camera.

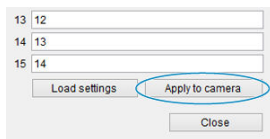

A screenshot of a camera settings dialog box. It features three input fields with the following values: 13, 14, and 15. Below the input fields are three buttons: 'Load settings', 'Apply to camera', and 'Close'. The 'Apply to camera' button is circled in blue.

13	12
14	13
15	14

Buttons: Load settings, Apply to camera, Close

- Select [**Apply to camera**] to set your new captions on the camera.

Controlling the Camera with Browser Remote

[✔ Configuring Browser Remote Connection Settings](#)

[✔ Displaying Browser Remote](#)

[✔ Browsing Images](#)

[✔ Shooting Remotely](#)

[✔ Registering IPTC Information](#)

[✔ Configuring FTP Server Settings](#)

[✔ Creating and Registering Captions](#)

Using a browser, you can browse and save camera images, shoot remotely, and perform other operations on a computer or smartphone.

Caution

- The following operations cannot be performed when the camera's still photo shooting/movie recording switch is set to <  >.
 - View image
 - Register IPCT information
 - FTP server settings
 - Create and register caption
- Some browser window sizes may prevent normal display.
- Do not use the browser's back and forward buttons.

Configuring Browser Remote Connection Settings

These instructions are continued from [Configuring Communication Function Settings](#). Specify a login name and password for accessing the camera from a computer. The login name and password you specify here are used when connecting to the camera.

1. Select [Full control] or [Browser *].

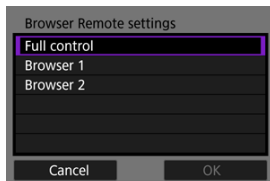

- Browser Remote enables camera access by users at up to three computers at once.
- The **[Full control]** account can use all Browser Remote features. This account is only available on one computer.
- The **[Browser *]** account is limited to browsing images on the camera and saving them to the computer. This account is available on up to two computers.

2. Configure the [Login name] or [Password].

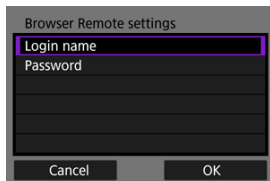

- Select **[Login name]** and **[Password]** to access the virtual keyboard (⌨) and enter the login name and password.
- Select **[OK]** to return to the screen in step 1. Follow steps 1–2 for each account to be used.

3. Select [OK].

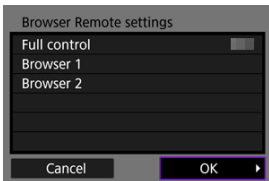

4. Select [OK].

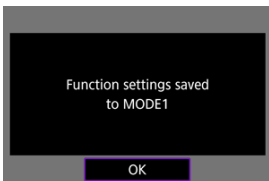

5. Select [OK].

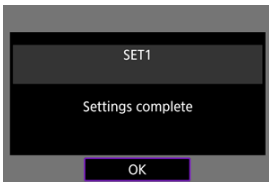

- Display returns to the **[Network settings]** screen.
- Setting information is stored on the camera.

Connection settings for Browser Remote are now complete.

 **Note**

- You can change account settings on the **[Account settings]** screen () , accessed by selecting **[Browser Remote settings]** in **[Connection option settings]**. The port number setting can also be changed on the **[Browser Remote settings]** screen by selecting **[Port no. (HTTP)]** or **[Port no. (HTTPS)]**. Note that there is normally no need to change the port number (80 for HTTP, 443 for HTTPS).

Displaying Browser Remote

From a browser, log in to the Browser Remote page on the camera. Make sure the camera and computer are already connected via a wired LAN connection.

Checking the camera's IP address

The camera's IP address, as displayed in step 5, must be entered in the browser address bar to access the camera from a browser.

1. Select [**Network settings**].

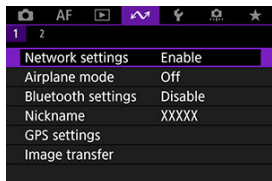

2. Select [**Connection settings**].

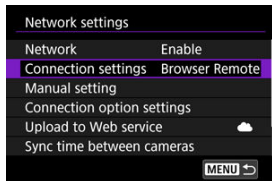

3. Select [**SET* Browser Remote**].

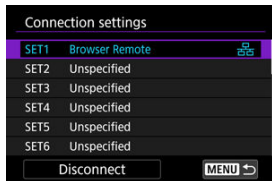

4. Select [Confirm settings].

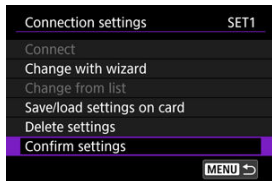

- Setting details are displayed.

5. Check the settings.

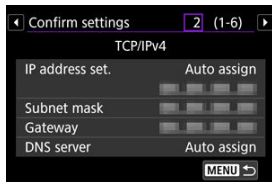

- Turn the <⦿> dial to access other pages.
- Write down the IP address.
- After checking, press the <MENU> button to close the confirmation screen.

Logging in to Browser Remote

6. Start a browser.

- Start a browser on the computer.

7. Enter the URL.

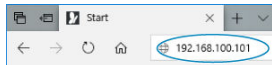

- In the address bar, enter the IP address you noted in step 5.
- Press the <Enter> key.

8. Enter the information for [Login name] and [Password].



- In **[Login name]** (user name) and **[Password]**, enter the information you specified in [Configuring Browser Remote Connection Settings](#).
- Select **[OK]** to display the top Browser Remote menu screen.

9. Configure default settings as needed.

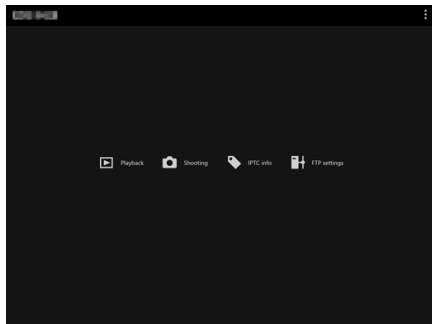

- Select **[☰]** to display the menu.

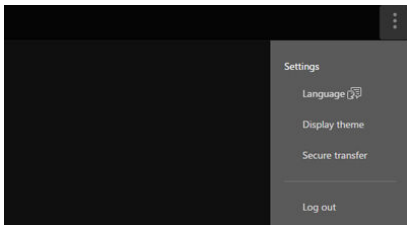

- **Language**

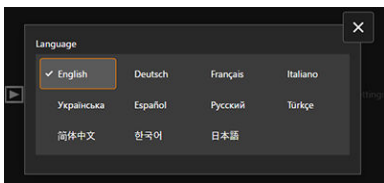

Enables you to select the display language.

- **Display theme**

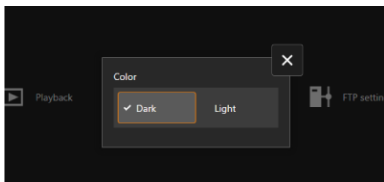

You can set the Browser Remote background color.

- **AF for still photo shooting**

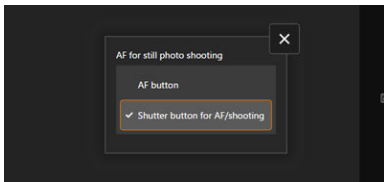

Displayed if you select **[Shooting]** in step 9.
Enables you to configure how autofocus is used in still photo shooting.

- **Rec function/card selection**

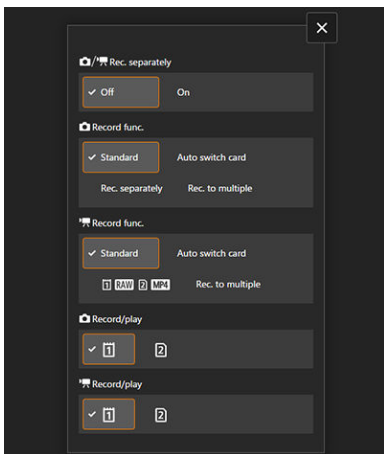

Displayed if you select **[Shooting]** in step 9.
Enables you to set the recording function and card selection.

- **Shutter mode**

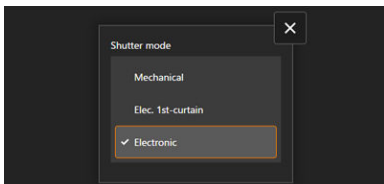

Displayed if you select **[Shooting]** in step 9.
You can set the shutter method for shooting still images.

- **Anti-flicker shoot.**

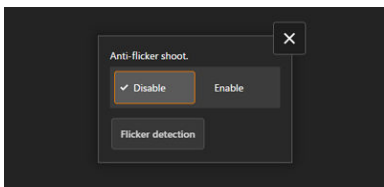

Displayed if you select **[Shooting]** in step 9.
Enables you to configure anti-flicker shooting.

- **HF anti-flicker shooting**

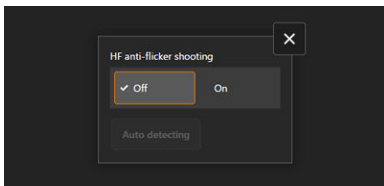

Displayed if you select **[Shooting]** in step 9.
Enables you to configure high-frequency anti-flicker shooting.

- **HTTPS settings**

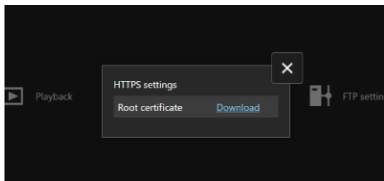

Enables you to download a root certificate and access an FTP server, when you will connect to the FTP server via HTTPS.

- **Log out**

Select to end the Browser Remote connection.

 **Caution**

- Browser Remote is not available unless the browser support JavaScript.
- Some menu items are not available when connected to the camera via Browser Remote.

Browsing Images

Enables you to browse images on cards in the camera.

1. Select [Playback].

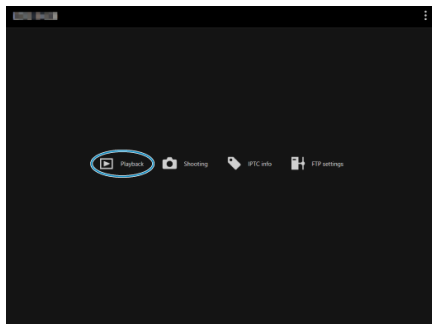

- The image browsing screen is displayed.

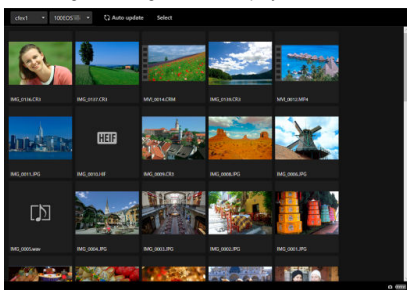

2. Select a card and folder.

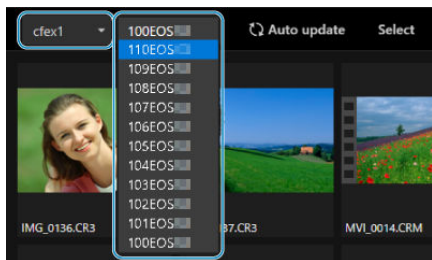

- Select a card in the pull-down list at left.
- Select a folder in the pull-down list at right.

3. Perform image operations as needed.

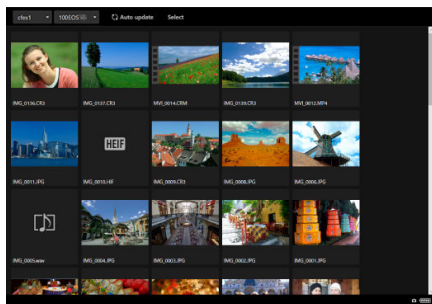

- The image taken is automatically displayed by turning on **[Auto update]**.

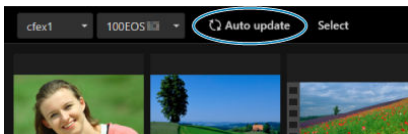

- With **[Select]** selected, you can select multiple images.

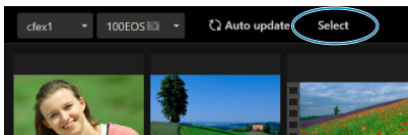

Selecting individual thumbnails selects each image separately.

Selecting thumbnails again clears the selection.

Selecting **[Select all]** marks all images on the browsing screen as selected.

Selecting **[Clear all]** clears selection of all images.

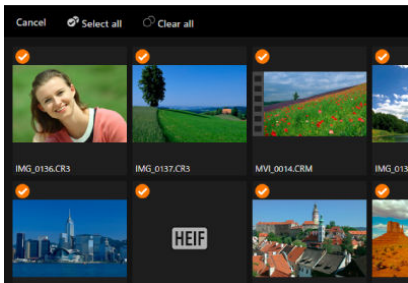

Selecting **[Cancel]** returns to the browsing screen.

- Selecting a thumbnail switches to the playback screen and shows the image enlarged.

Still photo playback screen

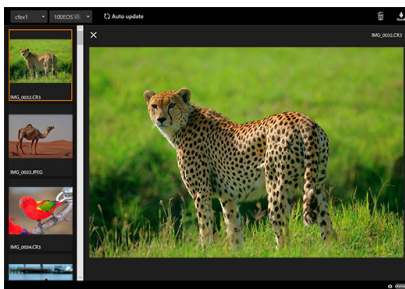

Movie playback screen

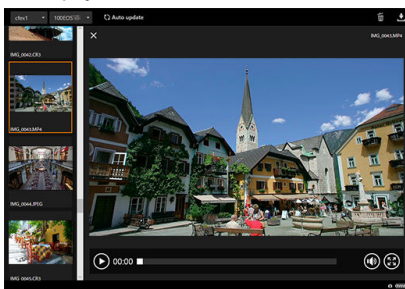

Audio playback screen

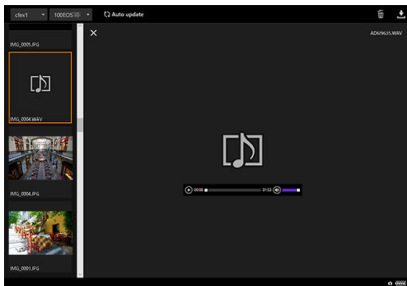

- Selecting an image and then  erases the image.

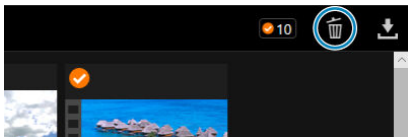

- Selecting an image and then the  button downloads the image to the computer.

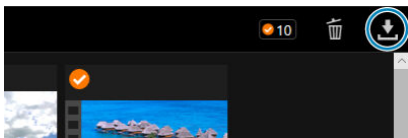

Note

- Computer performance and the browser used may prevent or delay image display or prevent image downloading.

Shooting Remotely

You can use Browser Remote to shoot remotely.

Shooting still photos

1. Select [Shooting].

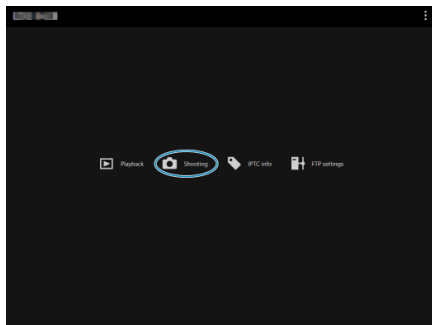

- The remote shooting screen is displayed.

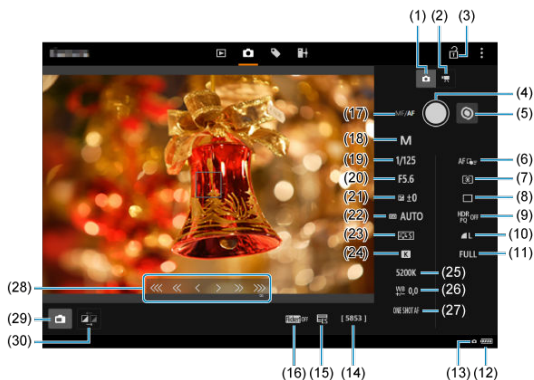

-
- | | |
|------|---------------------------------------|
| (1) | Still photo shooting button |
| (2) | Movie shooting button |
| (3) | Multi-function lock icon |
| (4) | Shutter button |
| (5) | MF toggle button |
| (6) | AF area |
| (7) | Metering mode |
| (8) | Drive mode |
| (9) | HDR shooting |
| (10) | Image quality |
| (11) | Still photo cropping/Aspect ratio |
| (12) | Battery level/Temperature warning |
| (13) | Browser Remote connection |
| (14) | Available shots |
| (15) | Electronic shutter |
| (16) | Anti-flicker shooting |
| (17) | AF button |
| (18) | Shooting mode |
| (19) | Shutter speed |
| (20) | Aperture value |
| (21) | Exposure compensation |
| (22) | ISO speed |
| (23) | Picture Style |
| (24) | White balance |
| (25) | Color temperature |
| (26) | White balance correction |
| (27) | AF operation |
| (28) | MF button |
| (29) | Live View shooting button |
| (30) | Live View image quality toggle button |
-

2. Select (1) Still photo shooting button.

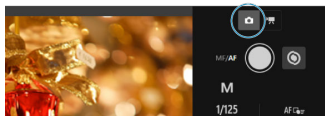

3. Set the lens's focus mode switch to < AF >.

4. Display the Live View image.

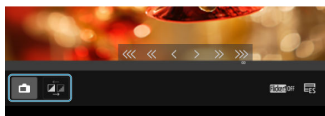

- To show or hide the Live View image, select (29) Live View shooting button.
- For more responsive Live View image display, select (30) Live View image quality toggle button, which will reduce Live View image quality to improve responsiveness. Select it again to restore the original image quality.

5. Set up shooting.

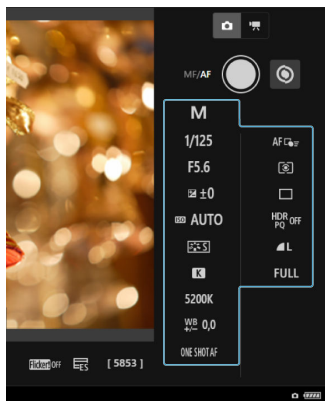

- Select setting items (such as image quality) to view the setting details, which you can configure.
- Configure the settings as needed.

6. Focus on the subject.

When using autofocus

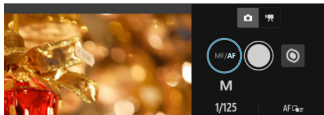

- To start AF with **[AF button]** selected in the **[AF for still photo shooting]** menu, select the (17) AF button.
- If you selected **[Shutter button for AF/shooting]** on the **[AF for still photo shooting]** menu, when you select the (4) Shutter button, AF is performed and a picture is taken.

When focusing manually

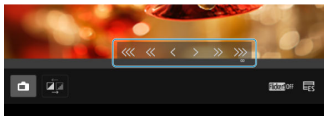
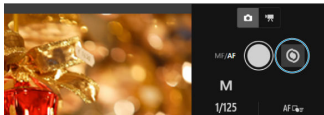

- To show/hide (28) MF button display, select (5) MF toggle button.
- Select (28) MF button, then focus manually. To adjust focus toward the foreground, use [**⏪ ⏪ <**], and to adjust focus toward the background, use [**> >>**].
- Three levels of focus adjustment are available.
 - ⏪ ⏪ >>> : Coarse
 - ⏪ >> : Intermediate
 - < > : Fine

7. Take the picture.

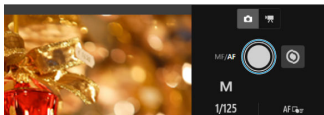

- Select the (4) Shutter button to shoot.
- Captured images are saved to the card in the camera.
- To browse and download images, see [Browsing Images](#).

⚠ Caution

- Depending on the communication status, image display or shutter release timing may be delayed.
- Still photo shooting is not available when the camera's still photo shooting/movie recording switch is set to <  >.

Recording movies

1. Select [Shooting].

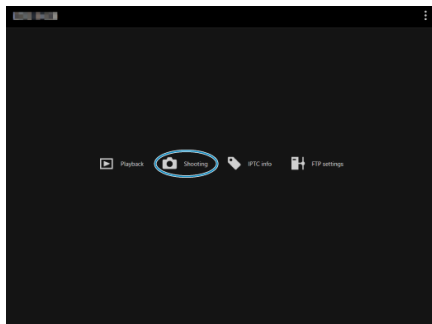

- The remote shooting screen is displayed.

2. Select (2) Movie shooting button.

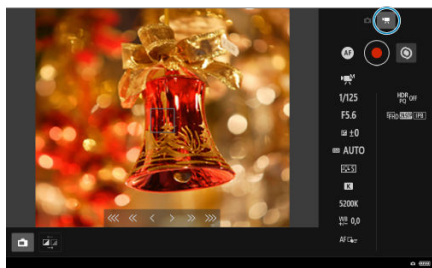

3. Configure settings as needed.

- Follow steps 3–6 in [Shooting still photos](#).

4. Record the movie.

Movie recording standby

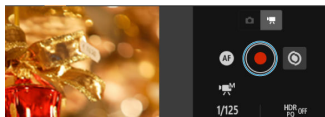

Movie recording in progress

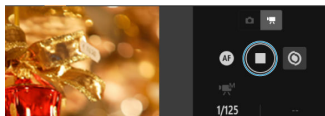

- Select (4) Shutter button, and when you release the button, movie recording begins.
- During movie recording, the red [○] on (4) Shutter button changes to a white [□].
- To stop movie recording, select (4) Shutter button again and release the button.

Registering IPTC Information

Enables you to edit and register IPTC* information (comments on images, such as captions, credits, and shooting locations) on the camera. Images can be tagged with IPTC information registered on the camera.

* International Press Telecommunications Council

1. Select [IPTC info].

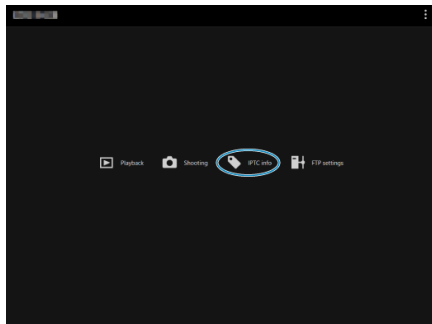

- A screen for editing IPTC information is displayed.

A screenshot of the IPTC information editing screen. It is divided into two main sections: "Image Content" and "Image Rights".
Image Content:
- Description/Caption: [text input]
- Description Writer: [text input]
- Headline: [text input]
- Keywords: [text input]
- Persons chosen: [text input]
- Featured City Name: [text input]
- Featured City Code: [text input]
- IPTC Scene: [text input]
Image Rights:
- Creator/Photographer: [text input]
- Creator's Job Title: [text input]
- Copyright: [text input]
- Credit: [text input]
- Source: [text input]
- Copyright URL: [text input]
- Rights Usage Terms: [text input]

2. Select [Load from file].



- To load IPTC information (in XMP format), select [**Load from file**].

3. Edit and register information as needed.

Image Content		
Description/Caption	Description Writer	Headline
data1	data2	data3
Keywords	Persons shown	Featured Org. Name
data4	data5	data6
Featured Org. Code	IPTC Score	
data7	data8	
Image Rights		
Creator/Photographer	Creator's Job Title	Copyright
data9	data10	data11
Credit	Source	Copyright URL
data12	data13	data14
Rights Usage Terms		
data15		

- Selecting [**Add to camera**] to applies the edited IPTC information to the camera.

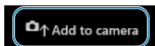

This also sets the camera's Custom Function [**Fn**: **Add IPTC information**] option to [**ON**].

- To save IPTC information (in XMP format), select [**Save to file**].

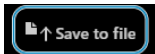

- Selecting [**Clear camera info**] deletes all IPTC information registered on the camera.

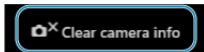

This also sets the camera's Custom Function [**Fn**: **Add IPTC information**] option to [**OFF**].

- Selecting [**Clear**] clears all IPTC information.

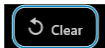

Configuring FTP Server Settings

If you will use FTP transfer for images captured remotely, you can use the camera's connection settings (🔗) to change the target FTP server.

1. Select [FTP settings].

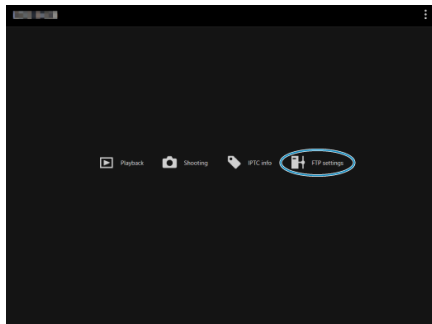

- The FTP setting screen is displayed.

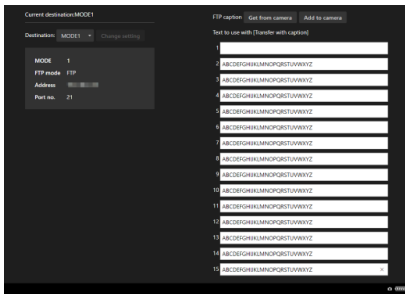

2. Select registered connection settings of the FTP server to use.

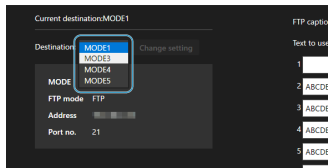

3. Select [Change setting].

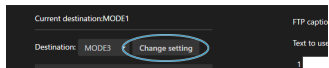

- The camera's connection settings are changed to your selected settings.

Note

- To use [FTP settings], you must register both [Browser Remote] (🔗) and [FTP transfer] (🔗) in the camera's connection settings.

Creating and Registering Captions

You can create captions and register them on the camera to use them as described in [Adding a Caption Before Transfer](#).

1. Select [FTP settings].

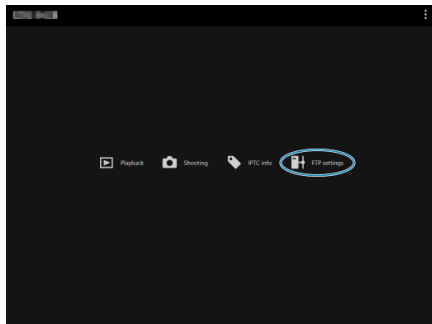

- The FTP setting screen is displayed.

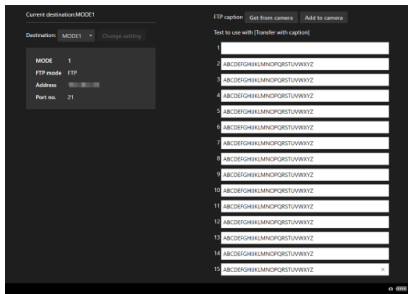

2. Enter the caption or captions.



- Enter up to 31 characters (in ASCII format).
- To acquire caption data stored on the camera, select [**Get from camera**].

3. Set the captions on the camera.

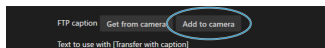

- Select [**Add to camera**] to set your new captions on the camera.

Ending Connections or Reconnecting

 [Ending Connections](#)

 [Reconnecting](#)

Ending Connections

1. Select [: Network settings].

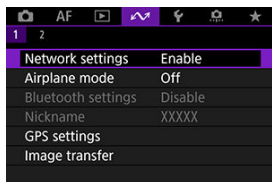

2. Select [Connection settings].

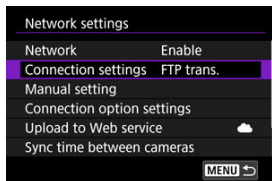

3. Select [Disconnect].

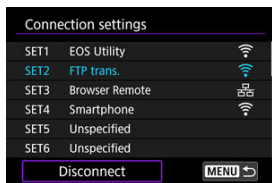

4. Select [OK].

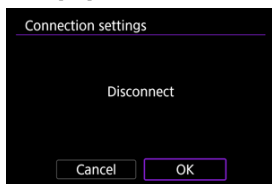

- The devices are disconnected.

1. Select [**W**]: Network settings].

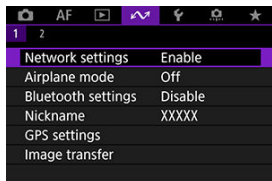

2. Select [Connection settings].

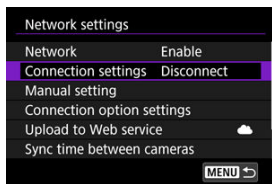

3. Select [SET*].

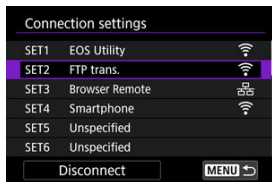

- In the saved settings, select settings to use for the connection.

4. Select [Connect].

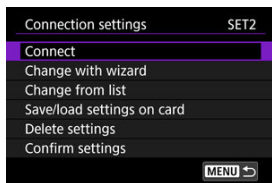

5. Select [OK].

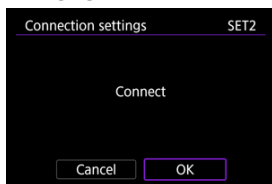

- The devices are connected again.
- If settings were changed on the target device, restore the previous settings to enable connections by the camera.

Airplane Mode

You can temporarily disable Wi-Fi functions.

1. Select [: Airplane mode].

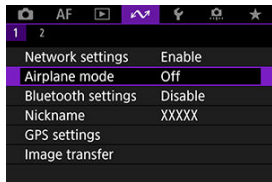

2. Set to [On].

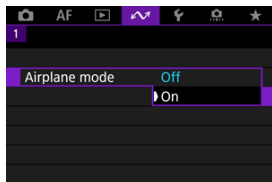

- [] is displayed on the screen.

Note

- [] may not be displayed in still photo shooting, movie recording, or playback, depending on display settings. If it is not displayed, press the <INFO> button repeatedly to access detailed information display.

Checking and Editing Network Settings

[☑ Checking and Editing Connection Settings](#)

[☑ Manually Editing Connection Settings](#)

[☑ Specifying Connection Options](#)

[☑ Checking the MAC Address](#)

Checking and Editing Connection Settings

You can check, change, or delete connection settings saved on the camera.

1. Select []: Network settings].

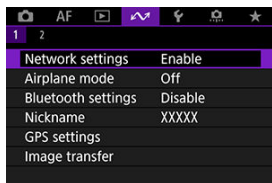

2. Select [Connection settings].

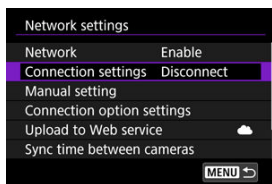

3. Select [SET*].

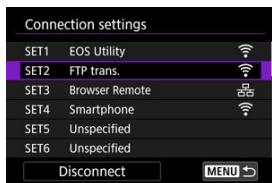

- In the saved settings, select settings to use for the connection.

4. Check or change the settings.

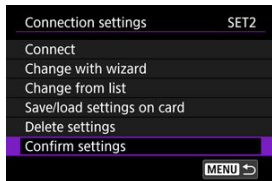

- **Connect**
 - Select to re-establish a connection (🔗).
- **Change with wizard/Change from list**
 - Change connection settings (🔗).
- **Save/load settings on card**
 - Save connection settings to a card, or load saved connection settings from a card into the camera (🔗).
- **Delete settings**
 - Select to delete connection settings.

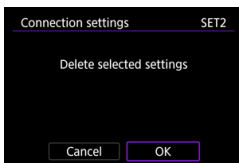

- Selecting [OK] deletes the settings.
- **Confirm settings**
 - Select to check connection settings.

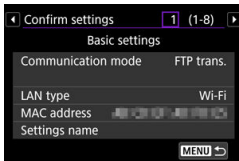

Changing connection settings

Settings originally completed using the connection wizard can be changed as follows.

Change with wizard

You can use the connection wizard to change connection settings saved on the camera.

1. Access the [Connection settings] screen.
 - Follow steps 1–3 in [Checking and Editing Connection Settings](#).
2. Select [Change with wizard].

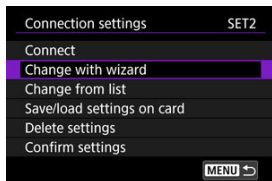

3. Use the connection wizard to change connection settings.

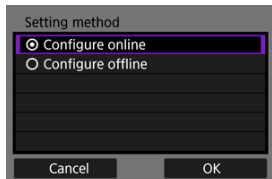

- See instructions starting with [Displaying the Connection Wizard](#).

Change from list

You can use communication and function settings saved on the camera to change connection settings saved on the camera. You can also register settings names.

1. Access the [Connection settings] screen.

- Follow steps 1–3 in [Checking and Editing Connection Settings](#).

2. Select [Change from list].

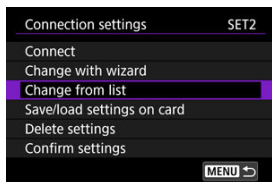

3. Select an option and change setting details as needed.

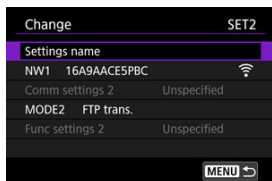

- **Settings name**

- Select to name sets of settings. Use the virtual keyboard (📄) to enter text.

- **NW*/Comm settings***

- Select to change, add, or clear communication settings.

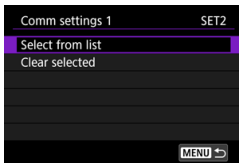

- Selecting [**Select from list**] lists communication settings saved on the camera. Select the communication settings to use. To view communication setting details, select settings and press the < **INFO** > button.
- Selecting [**Clear selected**] clears communication settings with registered connection settings. Select [**OK**] on the confirmation screen.

- **MODE*/Function settings***

- Select to change, add, or clear function settings.

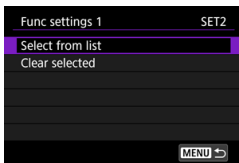

- Selecting [**Select from list**] lists function settings saved on the camera. Select the function settings to use. To view function setting details, select settings and press the < **INFO** > button.
- Selecting [**Clear selected**] clears function settings with registered connection settings. Select [**OK**] on the confirmation screen.

 **Note**

- You can register two sets of communication and function settings to a single set of connection settings. Note that depending on setting details, only one set can be registered in some cases.
- Clearing all function settings also clears communication settings, and the connection settings will be labeled [**Unspecified**].

Saving and loading settings

Connection settings can be saved on a card and applied to other cameras. Connection settings configured on other cameras can also be applied to the camera you will use.

Note

- [🔧: **Save/load cam settings on card**] enables you to save all communication settings on the camera to a card or load all communication settings for another camera from a card.

Saving settings

1. Access the [Connection settings] screen.
 - Follow steps 1–3 in [Checking and Editing Connection Settings](#).
2. Select [Save/load settings on card].

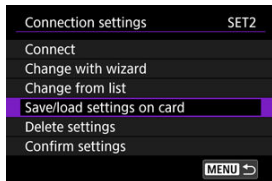

3. Select [Save settings to card].

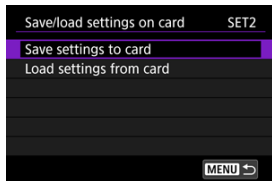

4. Select [OK].

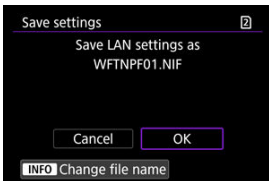

- The file name is determined automatically by the camera: WFTNPF, followed by a number (01 to 40) and the extension NIF. To rename the file as desired, press the <INFO> button.
- The settings are saved to the card.
- The settings file is saved to an area of the card shown when the card is opened (in the root directory).

⚠ Caution

- 40 settings files can be saved on one card from the camera. To save 41 or more, use another card.

1. Access the [Connection settings] screen.
 - Follow steps 1–3 in [Checking and Editing Connection Settings](#).

2. Select [Save/load settings on card].

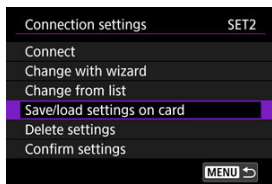

3. Select [Load settings from card].

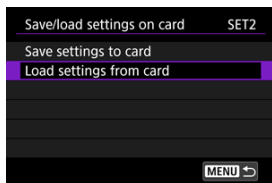

4. Select a settings file.

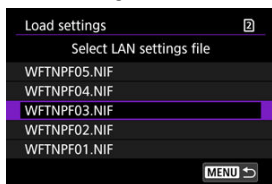

- Select a settings file that matches your network environment.

5. Select [OK].

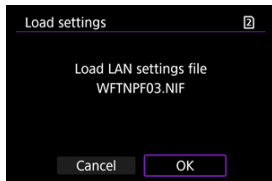

- Information from the settings file is loaded into the selected settings number.

Caution

- Even if a computer or other device is used to save 41 or more settings files on a card, only 40 are displayed on the camera's screen for loading settings. To load 41 or more settings files, load 40 from one card, then load remaining files from another card.

Note

- **[ Save/load cam settings on card]** enables you to save all communication settings on the camera to a card or load all communication settings for another camera from a card.

Manually Editing Connection Settings

You can add, change, or delete communication and function settings saved on the camera. You can also configure settings that are not set using the connection wizard, such as a setting that determines what happens if files with the same name as existing files are sent to the FTP server.

Editing communication settings

1. Select []: Network settings].

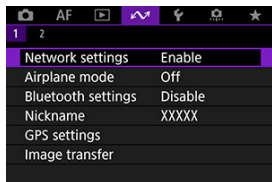

2. Select [Manual setting].

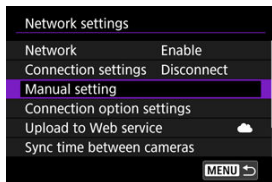

3. Select [Comm settings].

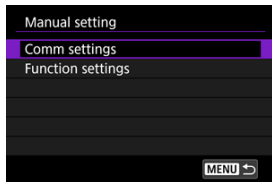

4. Select [NW*].

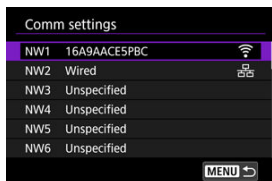

- Select saved settings to edit.

5. Change, delete, or check the settings as needed.

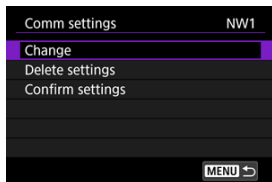

- **Change**

- Select to change individual settings in sets of communication settings.

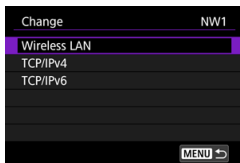

- Selecting [**Wireless LAN**] enables you to change the target SSID, for example.
- Selecting [**TCP/IPv4**] enables you to configure network-related settings such as the IP address.
- Selecting [**TCP/IPv6**] enables you to configure settings used for IPv6 (🔗).
- Depending on the communication setting, not all items may be displayed.

- **Delete settings**

- Select to delete communication settings.



- Selecting [**OK**] deletes the settings.

- **Confirm settings**

- Select to check communication settings.

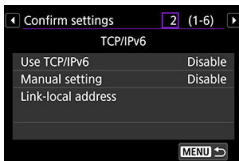

Editing function settings

1. Select [**W**: Network settings].

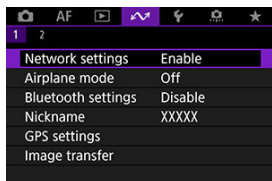

2. Select [**M**: Manual setting].

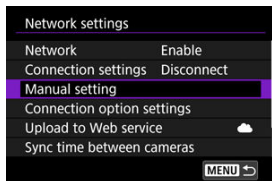

3. Select [**F**: Function settings].

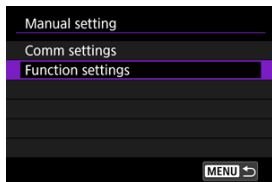

4. Select [**MODE***].

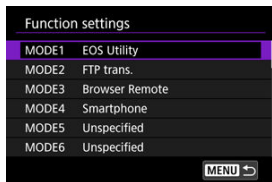

- Select saved settings to edit.

5. Change, delete, or check the settings as needed.

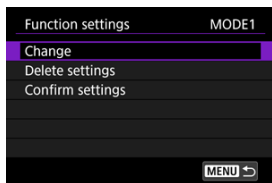

● Change

- Selecting [**Change mode name**] enables you to use the virtual keyboard (📄) to rename the mode.

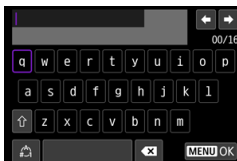
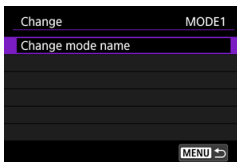

- Selecting **[FTP server]** enables you to configure settings related to the FTP server.

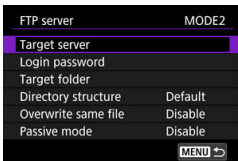
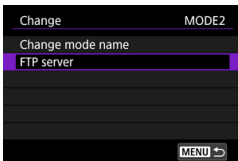

[Directory Structure of the Target Folder](#)

[Overwriting Files of the Same Name](#)

[Passive Mode](#)

[Trusting Target Servers](#)

- Selecting [**Viewable imgs**] enables you to specify which images can be viewed on smartphones.

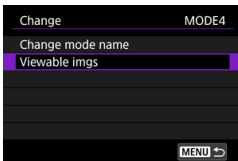

[☑ Settings to Make Images Viewable from Smartphones](#)

● **Delete settings**

- Select to delete function settings.



- Selecting [**OK**] deletes the settings.

● **Confirm settings**

- Select to check function settings.

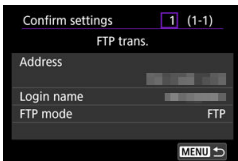

Directory structure of the target folder

Configured in **[FTP server]** → **[Directory structure]**.

With **[Default]**, the root folder is used for image storage. If you have created a subfolder in the root folder by changing the **[Target folder]** setting, images are saved in that folder. Selecting **[Camera]** automatically creates a folder structure matching that of the camera's (such as A/DCIM/100EOSR3) in the server's root folder for image storage. If you have created a subfolder in the root folder by changing the **[Target folder]** setting, a folder structure such as A/DCIM/100EOSR3 is automatically created in that folder for image storage.

Overwriting files of the same name

Configured in **[FTP server]** → **[Overwrite same file]**.

With [Overwrite same file] set to [Disable]

If there is already a file with the same name in the target folder on the FTP server, the new file is saved with an extension consisting of an underscore and a number, as in IMG_0003_1.JPG.

When you resend images if initial transfer fails

Even if the camera is configured to overwrite files of the same name, if you resend an image file that could not be transferred initially, the existing file may not be overwritten in some cases. If this happens, the new file is saved with an extension consisting of an underscore, a letter, and a numeral, as in IMG_0003_a1.JPG.

Passive mode

Configured in **[FTP server]** → **[Passive mode]**.

Enable this setting in network environments protected by a firewall. If an Error 41 occurs (Cannot connect to FTP server), setting passive mode to **[Enable]** may enable access to the FTP server.

Trusting target servers

Configured in **[FTP server]** → **[Trust target server]**.

Set to **[Enable]** if you prefer to connect to FTP servers even when trust cannot be established based on the root certificate used. In this case, take suitable security measures.

Specifying Connection Options

You can configure settings used for FTP transfer and Browser Remote. Settings are also available for authentication information used in LAN environments with 802.1X authentication.

1. Select [: Network settings].

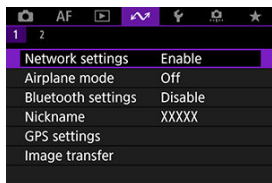

2. Select [Connection option settings].

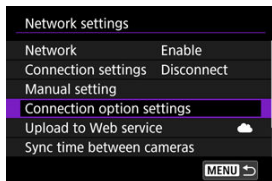

3. Select an option to configure.

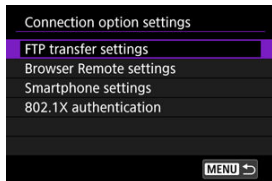

- [FTP transfer settings](#)
- [Browser Remote settings](#)
- [Smartphone settings](#)
- [802.1X authentication](#)

FTP transfer settings

Selecting **[FTP transfer settings]** enables you to configure settings related to FTP transfer and power saving.

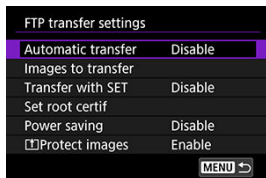

- **Automatic transfer / Images to transfer / Transfer with SET / Set root certif**
 - For details, see [Image Transfer to FTP Servers](#).
- **Power saving**
 - When **[Enable]** is set and no image is transferred for a certain period, the camera will log off from the FTP server and disconnect from the LAN. The connection is re-established automatically when the camera is ready for image transfer again. If you prefer not to disconnect from the LAN, set to **[Disable]**.
- **[↑]Protect images**
 - To automatically protect images transferred via FTP, set to **[Enable]** (☑).

Browser Remote settings

Selecting [**Browser Remote settings**] enables you to set the account used for Browser Remote access and configure HTTP/HTTPS communication settings.

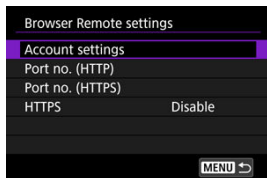

- **Account settings**

- For details, see [Configuring Browser Remote Connection Settings](#).

- **Port no. (HTTP)/Port no. (HTTPS)**

- You can change the port number used for HTTP/HTTPS communication. There is normally no need to change the port number (80 for HTTP, 443 for HTTPS).

- **HTTPS**

- Selecting [**Enable**] enables HTTPS communication for Browser Remote access.

Smartphone settings

Selecting **[Send to smartphone after shot]** in **[Smartphone settings]** enables you to set the size of images to send automatically.

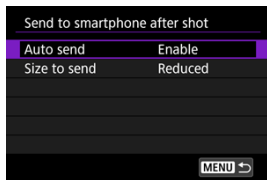

- **Auto send / Size to send**

- For details, see [Automatic Image Transfer as You Shoot](#).

802.1X authentication

Selecting **[802.1X authentication]** enables you to set, check, or delete 802.1X authentication settings, using a setup wizard.

Configure these settings when connecting to networks that require 802.1X authentication.

First, save the certificate for the type of 802.1X authentication used to a card in the camera. File types and names that can be loaded using this function are as follows.

Type	File Name
Root certificate	8021X_R.CER
	8021X_R.CRT
	8021X_R.PEM
Client certificate	8021X_C.CER
	8021X_C.CRT
	8021X_C.PEM
	8021X_C.P12
	8021X_C.PFX
Private key	8021X_C.KEY

Note that the camera supports following protocols.

Protocol	Supported Authentication
EAP-TLS	X.509, PKCS#12
EAP-TTLS	MSCHAPv2
PEAP	MSCHAPv2

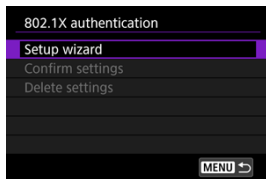

- **Setup wizard**
 - Follow the wizard to configure the authentication settings.
- **Confirm settings**
 - Select to check authentication settings.
- **Delete settings**
 - Select to delete authentication settings. Selecting [**OK**] on the screen displayed deletes the settings.

Checking the MAC Address

You can check the camera's MAC address.

1. Select [**W**]: Network settings.

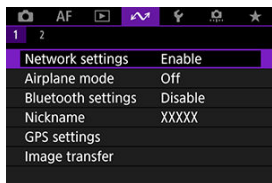

2. Select [**MAC address**].

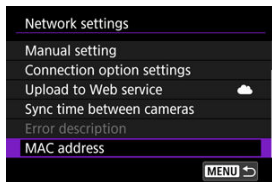

3. Check the MAC address.

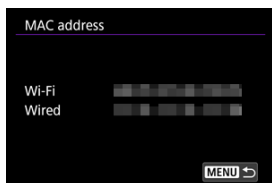

- The MAC addresses for [**Wi-Fi**] and [**Wired**] are displayed.

Syncing Time Between Cameras

 [Preparing for Time Syncing](#)

 [Syncing the Time](#)

You can set the sender camera time on up to 10 receiver cameras. Note that even after synchronization, a slight margin of error applies between sender and receiver camera time (of ± 0.05 seconds, at most).

Caution

- Always use cameras of the same model to sync the time. Synchronizing the time on receiver cameras is not possible with different models of the sender and receiver cameras.
- This feature will not be available after 2038.

Preparing for Time Syncing

When using a single receiver camera, connect a LAN cable to the Ethernet RJ-45 terminal of the sender and receiver cameras.

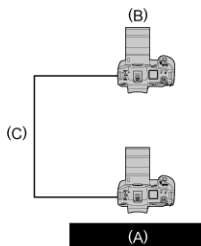
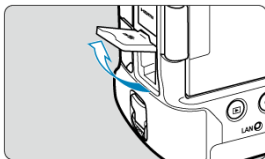

- (A) Sender camera
- (B) Receiver camera
- (C) LAN cable

When using multiple receiver cameras, connect a LAN cable from the Ethernet terminal of the sender and receiver cameras to a hub. Up to 10 receiver cameras can be connected.

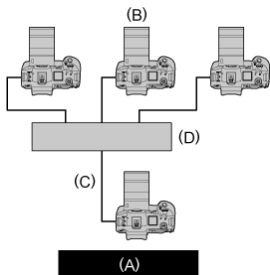

- (A) Sender camera
- (B) Receiver camera
- (C) LAN cable
- (D) Hub

Use a highly shielded Category 5e or higher STP (Shielded Twisted Pair) Gigabit Ethernet cable.

Syncing the Time

Preparing the sender camera

First, set up the camera to use as a sender.

1. On the camera, press the <MENU> button.
2. Select [: Network settings].

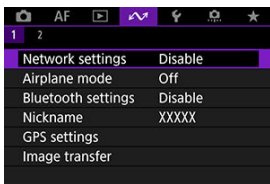

3. In [Network], select [Enable].

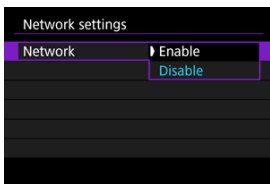

4. Select [Sync time between cameras].

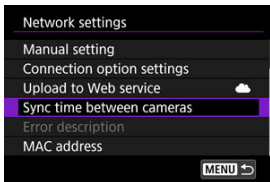

- If the camera is already connected to another device, [Set [Connection settings] to [Disconnect]] is displayed. Select [OK] to end the connection.

5. Select **[OK]**.

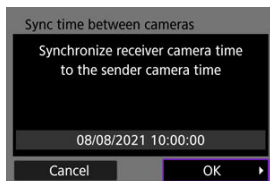

6. Select **[OK]**.

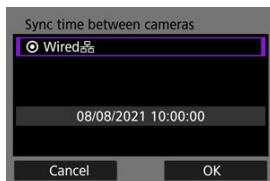

7. Select **[Sender]**.

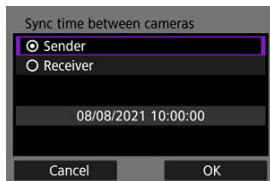

- Select **[OK]** to go to the next screen.
- After the screen is displayed, the camera is ready.

Preparing receiver cameras

Set up cameras to use as receivers.

1. Follow steps 1–6 in **Preparing the Sender Camera**.
2. Select **[Receiver]**.

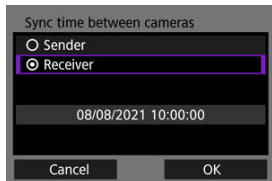

- Select **[OK]** to go to the next screen.

3. Select **[OK]**.

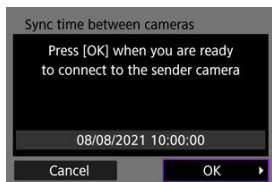

- The following screen is displayed.

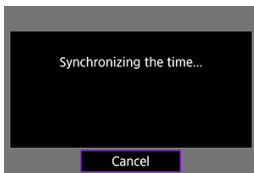

- To set the time on multiple receiver cameras, follow steps 1–2 on each receiver camera.
- The number of receiver cameras detected is displayed on the sender camera screen.

Syncing time between sender and receiver cameras

Sync the time on the sender and receiver cameras as follows.

1. Follow steps 1–6 in **Preparing the sender camera** and steps 1–3 in **Preparing receiver cameras**.
2. On the sender camera, select **[OK]**.

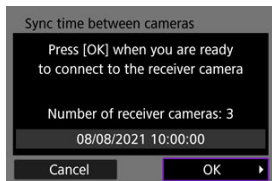

- Check the number of receiver cameras, then select **[OK]**.
- After the time is synchronized, the next screen is displayed.

3. Select **[OK]** on all of the cameras.

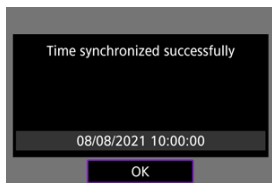

Setting Up GPS Features

 [GPS Settings](#)

 [GPS Precautions](#)

GPS features of the camera can be used to geotag images, set the time, and more. The camera can receive signals from GPS satellites (USA), GLONASS satellites (Russia), and the Quasi-Zenith Satellite System "Michibiki" (Japan).

Caution

- Geotag information may not be recorded or inaccurate information may be recorded where GPS signal coverage is poor, such as in the following places.
 - Indoors, underground, near or between buildings, in tunnels or forests
 - Near high-voltage power lines or mobile phones operating on the 1.5 GHz band
 - When the camera is carried in a bag or other container
 - When traveling long distances
 - When traveling through different environments
 - Even in conditions other than these, GPS satellite movement over time may interfere with geotagging and cause missing or inaccurate geotag information. The information may also indicate that the camera was used along a route even if it was used at one location.
- Elevation is not as accurate as latitude or longitude, due to the nature of GPS.
- Internally, the camera's GPS antenna is near the front of the multi-function shoe. Although GPS signals can also be acquired with a Speedlite attached, acquisition sensitivity will be slightly lower.
- When carrying the camera in a bag or other container, make sure it is face-up with nothing covering it.
- Set the camera time and date as accurately as possible. Also set the correct time zone and daylight saving time for the shooting location.
- Fewer shots are available in locations with poor signal coverage.
- Remaining battery capacity may be lower when GPS features are used. Charge the battery as needed, or consider purchasing a spare battery (sold separately).
- Others may be able to locate or identify you by using information in your geotagged still photos or movies. Be careful when sharing these images with others, as when posting images online where many people can view them.

1. Select [GPS: GPS settings].

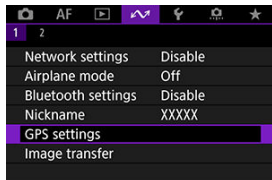

2. Configure GPS details.

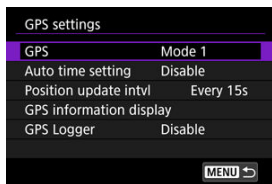

GPS

Specify the GPS operating mode.

- In [**Mode 1**], the camera continues to acquire GPS signals at regular intervals with the power switch set to < **ON** > or even < **OFF** >.
- In [**Mode 2**], the camera acquires GPS signals with the power switch set to < **ON** >. Setting the power switch to < **OFF** > also deactivates GPS features. Note that after auto power off is activated, the camera continues to receive GPS signals at regular intervals.

When acquiring GPS signals, use the camera outdoors where the sky is unobstructed and aim it up, keeping your hand and other objects off the top. Signal acquisition under favorable conditions takes approx. 30–60 sec., and then [**GPS**] is lit on the screen or LCD panel. Shots taken when [**GPS**] is lit are geotagged.

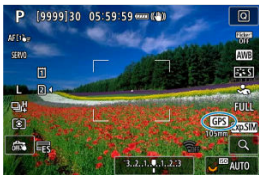



⚠ Caution

- When [**Mode 1**] is set, the camera continues to acquire GPS signals at regular intervals even with the power switch set to < **OFF** >, which drains the battery faster and reduces the number of shots available. Set to [**Disable**] if you will not use the camera for some time.
- If auto power off continues for an extended period in [**Mode 2**], the battery will be drained faster and fewer shots will be available. Set the power switch to < **OFF** > if you will not use the camera for some time.

Auto time setting

Time information acquired from GPS signals can be set on the camera. The margin of error is approx. ± 0.02 sec. Selecting [**Auto update**] will update the time when GPS signals are received while the camera is on.

Caution

- The time cannot be automatically updated unless signals from at least five GPS satellites can be acquired. [**Set now**] will be grayed-out and unavailable.
- Even if [**Set now**] can be selected, time adjustment may not be possible, depending on the timing of GPS signal acquisition.
- Setting [**Auto time setting**] to [**Auto update**] prevents the date or time from being manually set with [: **Date/Time/Zone**] ().
- If you have performed [**Sync time between cameras**] and prefer not to have the time adjusted, set [**Auto time setting**] to [**Disable**].

Position update interval

You can set the positioning interval (time) for updating geotag information. Although tagging is more accurate when the geotag information is updated at shorter intervals, this reduces the number of shots available because it drains the battery faster.

Caution

- Some inconsistency in positioning intervals is inevitable, due to the nature of GPS.

GPS information display

Shows acquired GPS information.

The [📶] icon indicates signal conditions. When [3D] is displayed, elevation is also recorded. Note that elevation is not recorded when [2D] is displayed.

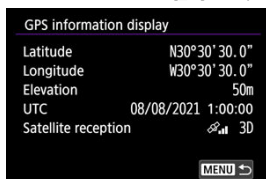

You can check geotag information by displaying a shot, pressing the <INFO> button to access playback screens with detailed information, and then pressing <⚙>.



- (1) Latitude
- (2) Longitude
- (3) Elevation
- (4) Coordinated Universal Time (UTC)

Note

- Movies are tagged with the geotag information acquired when you start recording. Note that signal reception conditions are not recorded.
- Coordinated Universal Time, abbreviated as UTC, is essentially the same as Greenwich Mean Time.

GPS logger

By setting [**Log GPS position**] to [**Enable**], you can automatically record geotag information at specific intervals along the route that the camera travels. Geotag information is recorded at the interval set in [**Position update intvl**] as log data saved in the camera's internal memory by date. You can also view the route traveled on a map displayed on a computer.

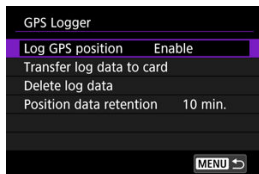

Position update intervals and log data capacity (in days) are as follows.

(Approx.)

Update Interval	Log Data	Update Interval	Log Data
Every sec.	4.1 days	Every 30 sec.	100 days
Every 5 sec.	20 days	Every min.	100 days
Every 10 sec.	41 days	Every 2 min.	100 days
Every 15 sec.	61 days	Every 5 min.	100 days

* With one day being equivalent to eight hours of log data

- Names of daily log files consist of the date and number (such as 19101000). New log file are created if the camera enters a new time zone (🌐).
- When the camera's internal memory becomes full, old log data is overwritten with new data.

Caution

- In **[Mode 1]**, GPS logging continues even with the power switch set to **<OFF>**.
- In **[Mode 2]**, setting the power switch to **<OFF>** deactivates GPS logging. However, GPS logging continues during auto power off.
- Geotag information added to images may be inaccurate under some traveling conditions, in some locations, or under some GPS settings.

Transferring log data to a card

You can transfer recorded log data to a card selected in **[Transfer log data to card]**.

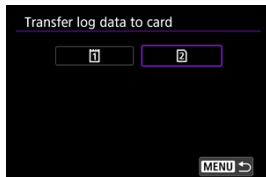

- Transferring log data to a card erases the data from the camera's internal memory.
- Log files transferred to a card are stored in the "GPS" folder within the "MISC" folder. They are saved with a ".LOG" file extension.

Deleting log data

To delete log data in internal memory, select **[Delete log data]**, then select **[OK]**. It may take approx. 1 min. to delete the data.

Position data retention

To continue geotagging images even where satellite coverage is poor (if you go indoors, for example) by using geotag information in log data, setting **[Position data retention]** to **[Unlimited]** is recommended. The most recently acquired geotag information is added to log data until new information can be acquired.

When a time such as **[10 min.]** is set, after geotag information cannot be acquired, the most recent geotag information is added to log data for the specified period.

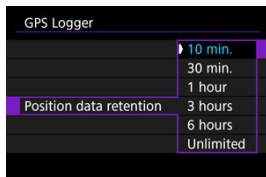

Countries/regions permitting use of GPS functions

Use of GPS features is restricted in some countries and regions, and illegal use may be punishable under national or local regulations. To avoid violating GPS regulations, visit the Canon website to check where use is allowed ([🔗](#)).

Note that Canon cannot be held liable for any problems arising from use of GPS functions in other countries and regions.

- Because the use of GPS may be restricted in some countries and regions, follow local laws and regulations where you will use the camera. Be particularly careful about using GPS functions outside your home country.
- Be careful about using GPS functions where the operation of electronic devices is restricted.
- Others may be able to locate or identify you by using location data in your geotagged still images or movies. Be careful when sharing these geotagged still images, movies, or GPS log files with others, such as when posting them online where many people can view them.
- GPS signal reception may take a longer time in some cases.

Connecting to a Wireless Remote Control

[Canceling the Pairing](#)

This camera can also be connected to Wireless Remote Control BR-E1 (sold separately, ) via Bluetooth for remote control shooting.

1. Select []: Bluetooth settings].

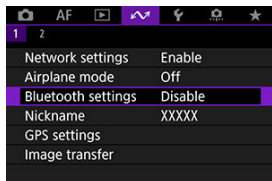

2. In [Bluetooth], select [Remote].

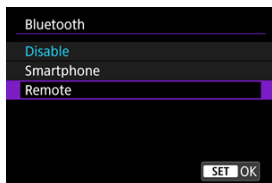

3. Select [Pairing].

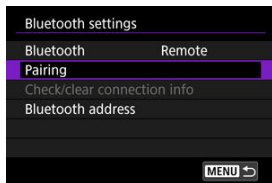





4. Pair the devices.



- When the [**Pairing**] screen appears, press and hold the <W> and <T> buttons on the BR-E1 simultaneously for at least 3 sec.
- After a message confirms that the camera is paired with the BR-E1, press <SET>.

5. Set up the camera for remote shooting.

- When shooting still photos, select [] or [>] as the drive mode ().
- For movie recording, set [: **Remote control**] to [**Enable**].
- For instructions after the pairing is complete, refer to the BR-E1's Instruction Manual.

Caution

- Bluetooth connections consume battery power even after the camera's auto power off is activated.

Note

- When you will not use Bluetooth, setting this function to [**Disable**] in step 2 is recommended.

Canceling the Pairing

Before pairing with a different BR-E1, clear the information about the connected remote control.

1. Select [**Bluetooth settings**].

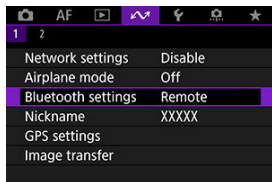

2. Select [**Check/clear connection info**].

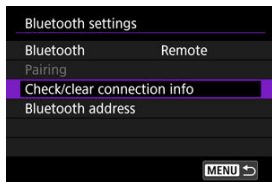

3. Press the < **INFO** > button.

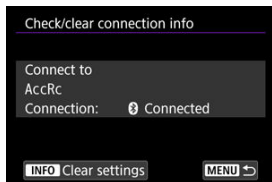

4. Select [OK].

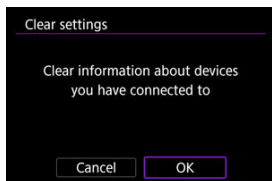

Reference

- [☑ Changing the Camera Nickname](#)
- [☑ Virtual Keyboard Operations](#)
- [☑ Configuring IPv6](#)

Changing the Camera Nickname

You can change the nickname of this camera (displayed on connected devices) as desired.

1. Select [: Nickname].

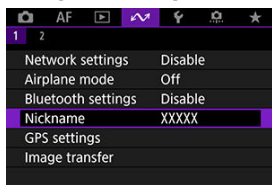

2. Enter text using the virtual keyboard ().

- When you finish entering characters, press the < MENU > button.

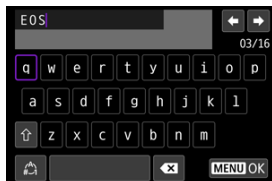

3. Select [OK].

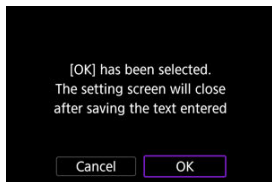

Virtual Keyboard Operations

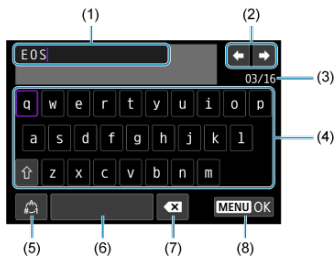

- (1) Input area, for entering text
- (2) Cursor keys, for moving in the input area
- (3) Current no. of characters/no. available
- (4) Keyboard
- (5) Switch input modes
- (6) Space
- (7) Delete a character in the input area
- (8) Exit input

Use < * > or the < ⦿ > or < ⦿ > dial to move within (2) and (4)–(7).
Press < SET > to confirm input or when switching input modes.

Configuring IPv6

To use IPv6, configure the settings manually.

Note

- If you are unsure what to enter, ask the network administrator or other person in charge of the network.

1. Select [Network settings].

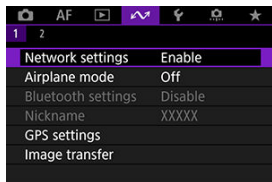

2. Select [Manual setting].

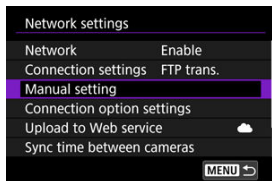

3. Select [Comm settings].

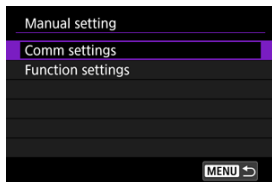

4. Select the communication settings that will use IPv6.

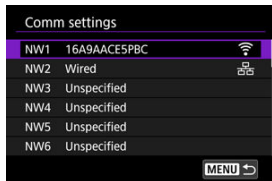

5. Select [Change].

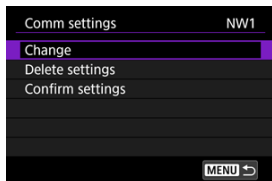

6. Select [TCP/IPv6].

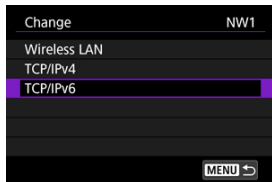

7. Select an option to configure.

TCP/IPv6	NW1
Use TCP/IPv6	Disable
Manual setting	Disable
DNS server	Auto assign
DNS address	
Manual address	
Prefix length	64

MENU →

● Use TCP/IPv6

TCP/IPv6	NW1
Use TCP/IPv6	Disable
	Enable

- Select **[Enable]** or **[Disable]** for IPv6.

● Manual setting

TCP/IPv6	NW1
Manual setting	Disable
	Enable

- To set the IP address manually, select **[Enable]**. **[DNS server]** is set to **[Manual setting]**, and you can configure **[DNS address]**, **[Manual address]**, **[Prefix length]**, and **[Gateway]**.

● DNS server

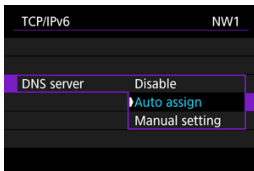

- To set the DNS server IP address manually, select **[Manual setting]**.
- Select **[Disable]** if you will not use a DNS server.
- If the setting is currently **[Auto assign]**, setting **[Manual setting]** to **[Enable]** changes it to **[Manual setting]**.

● DNS address/Manual address/Gateway

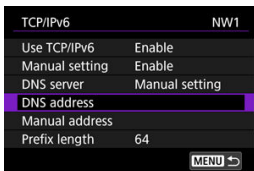

- Select an option and enter the IP address.



● Prefix length



- To set the prefix length, turn the dial to select a value (1–128).

Troubleshooting

- [☑ Responding to Error Messages](#)
- [☑ Troubleshooting Guide](#)
- [☑ Communication Function Precautions](#)
- [☑ Security](#)
- [☑ Checking Network Settings](#)

Responding to Error Messages

Resolve any errors displayed on the camera screen by referring to these examples of corrective actions. When errors occur, the <LAN> lamp on the camera blinks. You can also check error details by accessing [: **Network settings**] → [**Error description**]. Click the following error numbers to jump to the corresponding section.

11	12				
21	22	23			
41	43	44	45	46	48
61	62	64	65		
71	72	73			
81					
91					
121	125	127			
130	131	132	134	135	

11: Connection target not found

- **In the case of [Smartphone], is Camera Connect running?**
 - Establish a connection using Camera Connect (🔗).
- **In the case of [EOS Utility], is EOS Utility running?**
 - Start EOS Utility and try to connect again (🔗).
- **Are the camera and the access point set to use the same encryption key for authentication?**
 - This error occurs if the encryption keys do not match when the authentication method for encryption is **[Open system]**.
Check upper- and lower-case letters, and make sure the correct encryption key for authentication is set on the camera (🔗).

12: Connection target not found

- **Are the target device and access point turned on?**
 - Turn on the target device and access point, then wait a while. If a connection still cannot be established, perform the procedures to establish the connection again.

21: No address assigned by DHCP server

What to check on the camera

- **On the camera, the IP address is set to [Auto setting]. Is this the correct setting?**
 - If no DHCP server is used, configure the setting after setting the IP address to **[Manual setting]** on the camera (🔗).

What to check on the DHCP server

- **Is the power of the DHCP server on?**
 - Turn on the DHCP server.
- **Are there enough addresses for assignment by the DHCP server?**
 - Increase the number of addresses assigned by the DHCP server.
 - Remove devices assigned addresses by the DHCP server from the network to reduce the number of addresses in use.
- **Is the DHCP server working correctly?**
 - Check the DHCP server settings to make sure it is working correctly as a DHCP server.
 - If applicable, ask your network administrator to ensure the DHCP server is available.

What to check on the network as a whole

- **Does your network include a router or similar device that serves as a gateway?**
 - If applicable, ask your network administrator for the network gateway address and set it on the camera (🔗, 🔗).
 - Make sure that the gateway address setting is correctly entered on all network devices including the camera.

Note

Responding to error messages 21–23

- Also check the following points when responding to errors numbered 21–23.
Are the camera and the access point set to use the same password for authentication?
 - This error occurs if the passwords do not match when the authentication method for encryption is set to **[Open system]**. Check upper- and lower-case letters, and make sure the correct password for authentication is set on the camera (🔗).

22: No response from DNS server

What to check on the camera

- **On the camera, the DNS address is set to [Manual setting]. Is this the correct setting?**
 - If no DNS server is used, set the camera's DNS address setting to [Disable] (🔗).
- **On the camera, does the DNS server's IP address setting match the server's actual address?**
 - Configure the IP address on the camera to match the actual DNS server address (🔗, 🔗).

What to check on the DNS server

- **Is the power of the DNS server on?**
 - Turn on the DNS server.
- **Are the DNS server settings for IP addresses and the corresponding names correct?**
 - On the DNS server, make sure IP addresses and the corresponding names are entered correctly.
- **Is the DNS server working correctly?**
 - Check the DNS server settings to make sure it is working correctly as a DNS server.
 - If applicable, ask your network administrator to ensure the DNS server is available.

What to check on the network as a whole

- **Does your network include a router or similar device that serves as a gateway?**
 - If applicable, ask your network administrator for the network gateway address and set it on the camera (🔗, 🔗).
 - Make sure that the gateway address setting is correctly entered on all network devices including the camera.

23: Device with same IP address exists on selected network

- **Is another device on the camera network using the same IP address as the camera?**
 - Change the camera's IP address to avoid using the same address as another device on the network. Otherwise, change the IP address of the device that has a duplicate address.
 - If the camera's IP address is set to **[Manual setting]** in network environments using a DHCP server, change the setting to **[Auto setting]** (🔗).

41: Cannot connect to FTP server

What to check on the camera

- **The camera's proxy server setting is [Enable]. Is this the correct setting?**
 - If no proxy server is used, set the camera's proxy server setting to **[Disable]** (🔗).
- **Do the camera's [Address setting] and [Port No.] settings match those of the proxy server?**
 - Configure the camera's proxy server address and port number to match those of the proxy server (🔗).
- **Are the camera's proxy server settings correctly set on the DNS server?**
 - Make sure the proxy server's **[Address]** is correctly set on the DNS server.
- **On the camera, does the FTP server's IP address setting match the server's actual address?**
 - Configure the IP address on the camera to match the actual FTP server address (🔗).
- **Are the camera and the access point set to use the same encryption key for authentication?**
 - This error occurs if the encryption keys do not match when the authentication method for encryption is **[Open system]**. Check upper- and lower-case letters, and make sure the correct encryption key for authentication is set on the camera (🔗).
- **On the camera, does the [Port number setting] for the FTP server match the actual port number of the FTP server?**
 - Configure the same port number (usually 21 for FTP/FTPS or 22 for SFTP) on the camera and FTP server. Configure the port number on the camera to match the actual FTP server port number (🔗).
- **Are the camera's FTP server settings correctly set on the DNS server?**
 - Make sure the FTP server's **[Server name]** is correctly set on the DNS server. Make sure the **[Server name]** for the FTP server is correctly set on the camera (🔗).

What to check on the FTP server

- **Is the FTP server working correctly?**
 - Configure the computer correctly to function as an FTP server.
 - If applicable, ask your network administrator for the FTP server address and port number, then set them on the camera.
- **Is the FTP server on?**
 - Turn on the FTP server. The server may have been turned off because of an energy-saving mode.
- **On the camera, does the FTP server's IP address setting (in [Address]) match the server's actual address?**
 - Configure the IP address on the camera to match the actual FTP server address (🔗).
- **Is the FTP server configured to restrict access to only some IP addresses?**
 - Check the camera's IP address in [Confirm settings] (🔗) and change the FTP server settings.
- **Is a firewall or other security software enabled?**
 - Some security software uses a firewall to restrict access to the FTP server. Change the firewall settings to allow access to the FTP server.
 - You may be able to access the FTP server by setting [Passive mode] to [Enable] on the camera (🔗).
- **Are you connecting to the FTP server via a broadband router?**
 - Some broadband routers use a firewall to restrict access to the FTP server. Change the firewall settings to allow access to the FTP server.
 - You may be able to access the FTP server by setting [Passive mode] to [Enable] on the camera (🔗).

What to check on the proxy server

- **Is the proxy server on?**
 - Turn on the proxy server.
- **Is the proxy server working correctly?**
 - Check the proxy server settings to make sure the server is working correctly as a proxy server.
 - If applicable, ask your network administrator for the proxy server's address setting and port number, then set them on the camera.

What to check on the network as a whole

- **Does your network include a router or similar device that serves as a gateway?**
 - If applicable, ask your network administrator for the network gateway address and set it on the camera (🔗, 🔗).
 - Make sure that the gateway address setting is correctly entered on all network devices including the camera.

43: Cannot connect to FTP server. Error code received from server.

What to check on the proxy server

- **Is the proxy server on?**
 - Turn on the proxy server.
- **Is the proxy server working correctly?**
 - Check the proxy server settings to make sure the server is working correctly as a proxy server.
 - If applicable, ask your network administrator for the proxy server's address setting and port number, then set them on the camera.

What to check on the network as a whole

- **Does your network include a router or similar device that serves as a gateway?**
 - If applicable, ask your network administrator for the network gateway address and set it on the camera (📄, 📄).
 - Make sure that the gateway address setting is correctly entered on all network devices including the camera.

What to check on the FTP server

- **Have you exceeded the maximum number of FTP server connections?**
 - Disconnect some network devices from the FTP server or increase the maximum number of connections.

44: Cannot disconnect FTP server. Error code received from server.

- **This error occurs from a failure to disconnect from the FTP server for some reason.**
 - Restart the FTP server and camera.

45: Cannot login to FTP server. Error code received from server.

What to check on the camera

- **On the camera, is the [Login name] set correctly?**
 - Check the login name for accessing the FTP server. Check upper- and lower-case letters, and make sure the correct login name is set on the camera (🔗).
- **On the camera, is the [Login password] set correctly?**
 - Check upper- and lower-case letters, and make sure the correct login password is set on the camera (🔗).

What to check on the FTP server

- **Do the user rights for the FTP server allow reading, writing, and log access?**
 - Configure the FTP server's user rights to allow reading, writing, and log access.
- **Is the folder specified as the transfer destination on the FTP server named with ASCII characters?**
 - Use ASCII characters for the folder name.

46: For the data session, error code received from FTP server

What to check on the FTP server

- **The connection was terminated by the FTP server.**
 - Restart the FTP server.
- **Do the user rights for the FTP server allow reading, writing, and log access?**
 - Configure the FTP server's user rights to allow reading, writing, and log access.
- **Do user rights allow access to the target folder on the FTP server?**
 - Configure the user rights for access to the target folder on the FTP server to allow saving images from the camera.
- **Is the FTP server on?**
 - Turn on the FTP server. The server may have been turned off because of an energy-saving mode.
- **Is the hard disk of the FTP server full?**
 - Increase available space on the hard disk.

48: Security of the connection to the target server cannot be verified. If you trust this server and connect, set [Trust target server] to [Enable].

- **This error occurs from a failure to confirm security of the target server connection when connecting via FTPS.**
 - Confirm that the certificate is set correctly.
 - Change [Trust target server] to [Enable] if you prefer to trust target servers regardless of certificate settings.

61: Selected SSID wireless LAN network not found

- **Are any obstacles blocking the line of sight between the camera and the antenna of the access point?**
 - Move the antenna of the access point to a position clearly visible from the point of view of the camera.

What to check on the camera

- **Does the SSID set on the camera match that of the access point?**
 - Check the SSID at the access point, then set the same SSID on the camera (🔗).

What to check at the access point

- **Is the access point turned on?**
 - Turn on the power of the access point.
- **If filtering by MAC address is active, is the MAC address of the camera in use registered at the access point?**
 - Register the MAC address of the camera used to the access point (🔗).

62: No response from wireless LAN terminal

What to check on the camera

- **Is the camera configured for communication in infrastructure mode?**
 - Configure the camera for communication in ad hoc mode.

What to check on the other device

- **Is there a nearby device for ad hoc communication with the camera?**
 - Set up another device for ad hoc communication near the camera.

64: Cannot connect to wireless LAN terminal

- **Are the camera and the access point set to use the same encryption method?**
 - The camera supports the following encryption methods: WEP, TKIP, and AES (🔗).
- **If filtering by MAC address is active, is the MAC address of the camera in use registered at the access point?**
 - Register the MAC address of the camera used to the access point. The MAC address can be checked on the [MAC address] screen (🔗).

65: Wireless LAN connection lost

- **Are any obstacles blocking the line of sight between the camera and the antenna of the access point?**
 - Move the antenna of the access point to a position clearly visible from the point of view of the camera.
- **The wireless LAN connection was lost, for some reason, and the connection cannot be restored.**
 - The following are possible reasons: excessive access to the access point from another device, a microwave oven or similar appliance in use nearby (interfering with IEEE 802.11n/g/b (2.4 GHz band)), or influence of rain or high humidity.

71: Cannot connect to receiver camera

- **Are you following the correct procedure to establish the connection with receiver cameras?**
 - Operate receiver cameras by following the correct instructions.
- **Are the receiver cameras too far from the sender camera?**
 - Bring the receiver cameras closer to the sender camera.

72: Cannot connect to sender camera

- **Are you following the correct procedure to establish the connection with the sender camera?**
 - Operate the sender camera by following the correct instructions.
- **Is the sender camera too far from the receiver cameras?**
 - Bring the sender camera closer to the receiver cameras.

73: Could not synchronize the time

- **Are you following the correct procedure to establish a connection between the sender and receiver camera?**
 - Operate the sender and receiver cameras by following the correct instructions (🔗).
- **Is the sender camera too far from the receiver cameras?**
 - Bring the sender and receiver cameras closer together.

81: Wired LAN connection lost

- **Is the LAN cable securely connected?**
 - Reconnect the LAN cable between the camera and server. Because the cable may be severed, try using another cable to connect the devices.
- **Is the hub or router on?**
 - Turn on the hub or router.
- **Is the server on?**
 - Turn on the server. The server may have been turned off because of an energy-saving mode.

91: Other error

- **A problem other than error code number 11 to 83 occurred.**
 - Turn the camera's power switch off and on.

121: Not enough free space on server

- **The target Web server does not have enough free space.**
 - Delete unnecessary images on the Web server, check the free space on the Web server, then try sending the data again.

125: Check the network settings

- **Is the network connected?**
 - Check the connection status of the network.

127: An error has occurred

- **A problem other than error code number 121 to 126 occurred while the camera is connected to the Web service.**
 - Try again to establish the Wi-Fi connection to image.canon.

130: The server is currently busy Please wait a moment and try again

- **The image.canon site is busy at the moment.**
 - Try accessing image.canon over Wi-Fi again later.

131: Try again

- **An error occurred when connecting to image.canon over Wi-Fi.**
 - Try again to establish the Wi-Fi connection to image.canon.

132: Error detected on server Try again later

- **The image.canon site is currently offline for maintenance.**
 - Try accessing image.canon over Wi-Fi again later.

134: Set the correct date and time

- **The date, time, and time zone settings are incorrect.**
 - Check the [: **Date/Time/Zone**] settings.



135: Web service settings have been changed

- **The settings for image.canon were changed.**
 - Check the image.canon settings.

Troubleshooting Guide

Troubleshoot camera issues by checking the camera and connected devices as described in this section. If troubleshooting does not resolve the problem, contact a Canon Service Center for product information and advice on product handling.

Cannot transfer images to an FTP server.

- Set the still photo shooting/movie recording switch to <  > if you will transfer images to an FTP server after shooting. Image transfer is not possible with the still photo shooting/movie recording switch set to <  >.

The camera heats up, and the transmission rate drops.

- Continuous wireless operation over an extended period in high temperatures may cause the camera's internal temperature to rise and slow down transfers.

Communication Function Precautions

In case of slower transmission, lost connections, choppy image display, or other problems when using communication functions, try the following corrective actions.

Access point and antenna installation location

- When using the camera indoors, install the access point in the same room where you are shooting.
- Install the device where people or objects do not come between the device and the camera.
- Install the device higher than the camera.
- Install the device as close as possible to the camera. In particular, note that during outdoor use in poor weather, rain may absorb radio waves and disrupt the connection.

Nearby electronic devices

If the wireless LAN transmission rate drops due to interference from the following electronic devices, stop using them or establish a connection away from them. Otherwise, switching to a wired LAN can resolve the issue.

- In IEEE 802.11b/g/n wireless networks, the camera communicates on the 2.4 GHz band. For this reason, the wireless LAN transmission rate may drop if there are nearby Bluetooth devices, microwave ovens, cordless telephones, microphones, smartphones, or similar devices operating on the same frequency band.

If security settings have not been properly set, the following problems may occur.

- **Transmission monitoring**

Third parties with malicious intent may monitor wireless LAN transmissions and attempt to acquire the data you are sending.

- **Unauthorized network access**

Third parties with malicious intent may gain unauthorized access to the network you are using to steal, modify, or destroy information. Additionally, you could fall victim to other types of unauthorized access such as impersonation (where someone assumes an identity to gain access to unauthorized information) or springboard attacks (where someone gains unauthorized access to your network as a springboard to cover their tracks when infiltrating other systems).

It is recommended to make use of the systems and functions to thoroughly secure your network, preventing these types of problems from occurring.

Checking Network Settings

- **Windows**

Open the Windows **[Command Prompt]**, then enter `ipconfig/all` and press the **<Enter>** key. In addition to the IP address assigned to the computer, the subnet mask, gateway, and DNS server information are also displayed.

- **macOS**

In macOS, open the **[Terminal]** application, enter `ifconfig -a`, and press the **<Return>** key. The IP address assigned to the computer is indicated in the **[en0]** item next to **[inet]**, in the format `****.***.***.***`.

For information about the **[Terminal]** application, refer to the macOS help.

To avoid using the same IP address for the computer and other devices on the network when manually configuring the IP address assigned to the camera (🔗), change the rightmost number.

Example: 192.168.1.**10**

Save/Load Communication Settings on Card

Settings on the wireless features tab can be saved on a card and applied to other cameras. Settings configured on the wireless features tab on other cameras can also be applied to the camera you will use.

Note

- [W: Save/load cam settings on card] enables you to save all communication settings on the camera to a card or load all communication settings for another camera from a card.

Saving settings

1. Select [W: Save/load comm. settings on card].

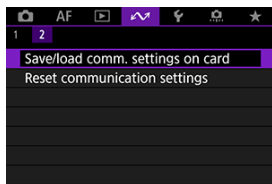

2. Select [Save to card].

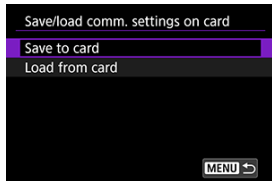

3. Select [OK].

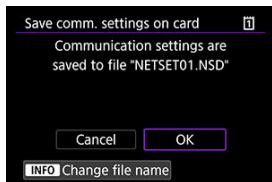

- The file name is set automatically by the camera. To rename the file as desired, press the <INFO> button.
- The settings are saved to the card.
- The settings file is saved to an area of the card shown when the card is opened (in the root directory).

Note

- Up to ten camera settings files can be saved on a card. If a card already has ten camera settings files, either overwrite existing files or use a different card.

1. Select [**W**]: Save/load comm. settings on card].

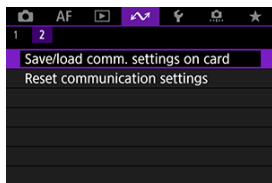

2. Select [**L**]: Load from card].

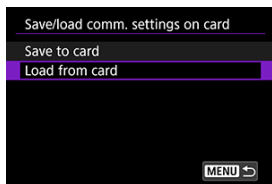

3. Select a settings file.

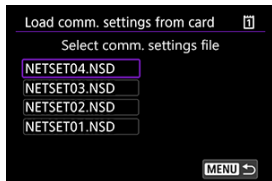

4. Select [OK].

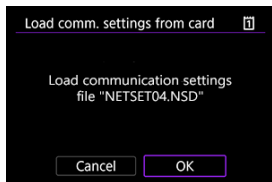

- Information from the settings file is loaded.

Caution

- Even if a computer or other device is used to save more than 10 settings files on a card, only 10 are displayed on the camera's screen for loading settings. When you have more than 10 settings files, divide them among multiple cards so that each card has no more than 10.
- Settings files saved by other camera models cannot be loaded.
- It may not be possible to load settings files that were saved by a camera with a different firmware version.

Resetting Communication Settings

All settings of network features can be cleared. This can prevent the information from being leaked if you lend the camera or transfer ownership.

1. Select [**W**]: Reset communication settings].

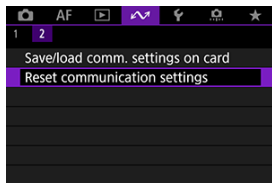

2. Select [**OK**].



Caution

- If you have paired the camera with a smartphone, on the smartphone's Wi-Fi settings screen, remove the Wi-Fi connection information of the camera for which you restored default wireless communication settings.

Set-up

This chapter describes menu settings on the set-up [] tab.

- [Tab Menus: Set-up](#)
- [Selecting Cards for Recording/Playback](#)
- [Folder Settings](#)
- [File Numbering](#)
- [File Naming](#)
- [Card Formatting](#)
- [Auto Rotate](#)
- [Adding Orientation Information to Movies](#)
- [Date/Time/Zone](#)
- [Language](#)
- [Video System](#)
- [Help](#)
- [Beeps](#)
- [Volume](#)
- [Headphones](#)
- [Power Saving](#)
- [Screen and Viewfinder Display](#)
- [Screen Brightness](#)
- [Viewfinder Brightness](#)
- [Screen and Viewfinder Color Tone](#)
- [Fine-Tuning Viewfinder Color Tone](#)
- [UI Magnification](#)
- [HDMI Resolution](#)
- [Touch Control](#)
- [Multi-Function Lock](#)
- [Shutter at Shutdown](#)
- [Sensor Cleaning](#)
- [App Selection for USB Connections](#)
- [Resetting the Camera](#)
- [Custom Shooting Mode \(C1–C3\)](#)
- [Save/Load Camera Settings on Card](#)
- [Battery Information](#)
- [Copyright Information](#)
- [System Status Display](#)
- [Other Information](#)

Tab Menus: Set-up

● Set-up 1

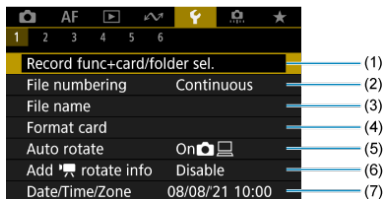

- (1) Record func+card/folder sel.
- [Selecting Cards for Recording/Playback](#)
 - [Creating a Folder](#)
- (2) [File numbering](#)
- (3) [File name](#)
- (4) [Format card](#)
- (5) [Auto rotate](#)
- (6) [Add rotate info](#)
- (7) [Date/Time/Zone](#)

● Set-up 2

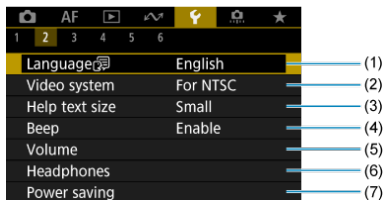

- (1) [Language](#)
- (2) [Video system](#)
- (3) [Help text size](#)
- (4) [Beep](#)
- (5) [Volume](#)
- (6) [Headphones](#)
- (7) [Power saving](#)

● Set-up 3

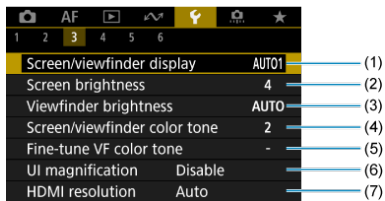

- (1) [Screen/viewfinder display](#)
- (2) [Screen brightness](#)
- (3) [Viewfinder brightness](#)
- (4) [Screen/viewfinder color tone](#)
- (5) [Fine-tune VF color tone](#)
- (6) [UI magnification](#)
- (7) [HDMI resolution](#)

● Set-up 4

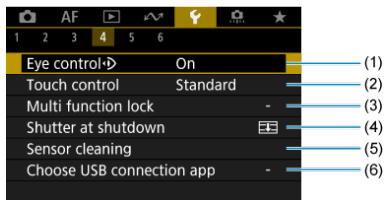

- (1) [Eye control](#)
- (2) [Touch control](#)
- (3) [Multi function lock](#)
- (4) [Shutter at shutdown](#)
- (5) [Sensor cleaning](#)
- (6) [Choose USB connection app](#)

● Set-up 5

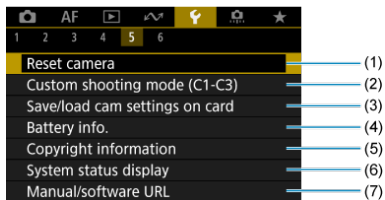

- (1) [Reset camera](#)
- (2) [Custom shooting mode \(C1-C3\)](#)
- (3) [Save/load cam settings on card](#)
- (4) [Battery info.](#)
- (5) [Copyright information](#)
- (6) [System status display](#)
- (7) [Manual/software URL](#)

● Set-up 6

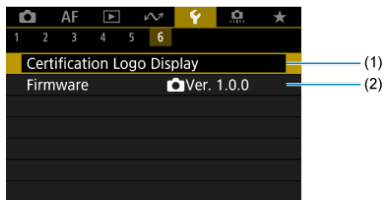

- (1) [Certification Logo Display](#)
- (2) [Firmware](#)

Selecting Cards for Recording/Playback

[Recording Method with Two Cards Inserted](#)

[Recording/Playback Selection with Two Cards Inserted](#)

Recording is possible when card 1 (1) or 2 (2) is in the camera (except under some conditions). With only one card inserted, there is no need to follow these steps.

With two cards inserted, you can select the recording method and card to use for recording and playback as follows.

Recording Method with Two Cards Inserted

1. Select [: Record func+card/folder sel.].

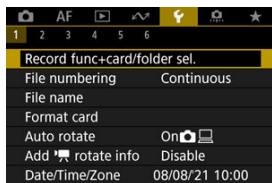



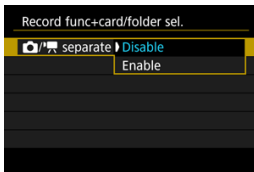

2. Set the recording method.

● separate





- Select **[Enable]** for automatic configuration of the recording method for still photos and movies. Movies are recorded to card **[1]** and still photos to card **[2]**.
- Movie recording is not possible if card **[1]** is full or not inserted.
- Without card **[2]** inserted, still photos can be captured but not saved. Still photo shooting is not possible if the card is full.

Caution

- Specifying **[Enable]** will make **[ Rec options]**, **[ Rec options]**, **[ Record/play]**, and **[ Record/play]** unavailable.

Note

- When set to **[Enable]**, card **[1]** is used for playback if the **<  >** button is pressed in movie recording mode. Card **[2]** is used for playback if the **<  >** button is pressed in still photo shooting mode.

● Rec options

Set the recording method for still photos.

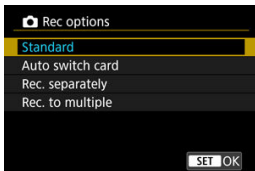



- **Standard**

Records still photos to the card selected in [ Record/play].

- **Auto switch card**



Same as [**Standard**], but additionally, the camera switches to the other card when one card becomes full. At this time, a new folder is created.

- **Rec. separately**

Enables you to set a specific image size for each card (). For each shot, a still photo is recorded to card  and  in your specified image quality.



Note that recording separately to **RAW** and **CRAW** is not available for RAW images.

- **Rec. to multiple**

For each shot, a still photo is recorded to card  and  in the same image quality.

Consider using an SD card with fast writing speeds for card , such as a UHS-II card.

Caution

- Maximum burst for [**Rec. separately**] is lower if you specify different image sizes for cards  and  ().



Note

Rec. separately/Rec. to multiple

- Images are recorded with the same file number to card [1] and [2].
- The number of shots available as shown in the viewfinder and on the Quick Control screen is for the card with less free space.
- [Card* full] is displayed when one of the cards becomes full, and shooting is no longer possible. To continue shooting, either replace the card or set [Rec options] to [Standard] and select the card with free space.
- See [Folder Settings](#) for details on [Folder] in [M: Record func +card/folder sel.].

● Rec options

Set the recording method for movies.

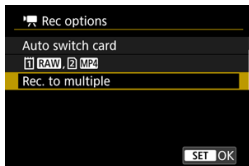
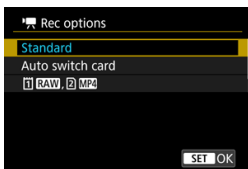

• **Standard**

Records movies to the card selected in [ **Record/play**].

• **Auto switch card**

Same as [**Standard**], but recording ends when the card becomes full. When you resume recording, the camera switches to the other card for recording. A new folder is created after switching cards.

• **1 RAW, 2 MP4**

For each recording, a RAW movie is recorded to card **1** and an MP4 movie to card **2**, both with the same file number. When one card becomes full, recording is no longer possible. Note that movie recording is not available when card **2** is an SD/SDHC card.

• **Rec. to multiple**

For each recording, the same movie is recorded to card **1** and **2**. Note that movie recording is not available when card **2** is an SD/SDHC card.





 **Caution**

Rec. to multiple

- Record to multiple is not available for the following movies.
 - RAW movies
 - 4K 59.94/50.00 fps ALL-I
 - 4K High Frame Rate movies

 **Note**

Rec. to multiple

- Images are recorded with the same file number to card  and .
- The number of shots available as shown in the viewfinder and on the Quick Control screen is for the card with less free space.
- **[Card* full]** is displayed when one of the cards becomes full, and shooting is no longer possible. To continue shooting, either replace the card or set [ **Rec options**] to **[Standard]** and select the card with free space.
- See [Folder Settings](#) for details on **[Folder]** in [: **Record func +card/folder sel.**].

Recording/Playback Selection with Two Cards Inserted

With [📷 Rec options]/[🎥 Rec options] set to [Standard] or [Auto switch card], select the card for recording and playback.

With [📷 Rec options] set to [Rec. separately] or [Rec. to multiple], or with [🎥 Rec options] set to [1 RAW, 2 MP4] or [Rec. to multiple], select the card for playback.

Setting via the menu

● Standard/Auto switch card

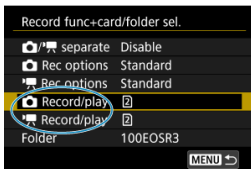

Select [Record/play].

- Select [📷 Record/play] for still photos or [🎥 Record/play] for movies.
[1]: Use card 1 for recording and playback
[2]: Use card 2 for recording and playback

● Rec. separately/Rec. to multiple/[1 RAW, 2 MP4]

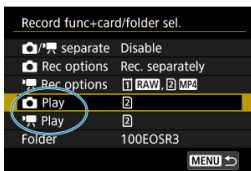

Select [Play].

- Select [📷 Play] for still photos or [🎥 Play] for movies.
- Pressing the <▶> button in still photo shooting mode plays images from the card selected in [📷 Play].
- Pressing the <▶> button in movie recording mode plays images from the card selected in [🎥 Play].



Note

- With [**Priority: 1**] set, the camera switches to the priority card when cards are inserted or removed.

Folder Settings

- [Creating a Folder](#)
- [Renaming Folders](#)
- [Selecting a Folder](#)

You can freely create and select the folder where the captured images are to be saved. You can also rename folders.

Creating a Folder

1. Select [: Record func+card/folder sel.].

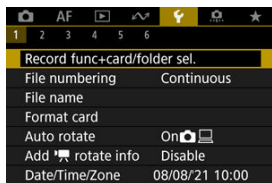

2. Select [Folder].

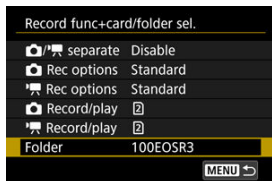

3. Select [Create folder].

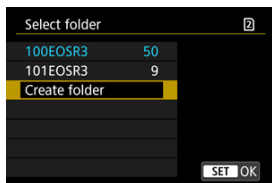

4. Select [OK].

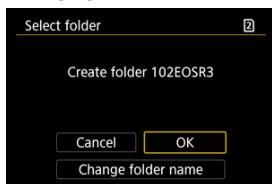

- To rename the folder, select [Change folder name].

1. Enter letters and numbers of your choice.

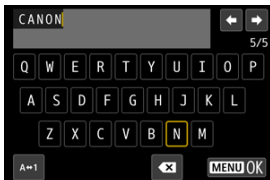

- You can enter five characters.
- By selecting [**A↔1**], you can change the input mode.
- To delete single characters, select [**X**] or press the button.



- Use the or dial or to select a character, then press to enter it.

2. Exit the setting.

- Press the **<MENU>** button, then press **[OK]**.

Selecting a Folder

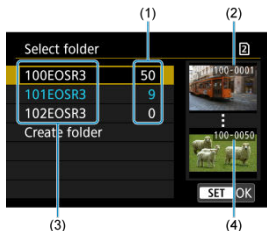

- (1) Number of images in folder
- (2) Lowest file number
- (3) Folder name
- (4) Highest file number

- Select a folder on the folder selection screen.
- Captured images are stored in your selected folder.

Note

Folders

- Folders are named as in "100EOSR3," with a three-digit folder number followed by five letters or numbers. A folder can contain up to 9999 images (file number 0001–9999). When a folder becomes full, a new folder with the folder number increased by one is created automatically. Also, if manual reset (Ⓜ) is executed, a new folder will be created automatically. Folders numbered from 100 to 999 can be created.

Creating folders with a computer

- With the card open on the screen, create a new folder with "DCIM" as the name. Open the DCIM folder and create as many folders as necessary to save and organize your images. "100ABC_D" is the required format for folder names, and the first three digits must be a folder number in the range 100–999. The last five characters can be any combination of upper- and lower-case letters from A to Z, numerals, and the underscore "_". The space cannot be used. Also note that two folder names cannot share the same three-digit folder number (for example, "100ABC_D" and "100W_XYZ") even if the remaining five characters in each name are different.

File Numbering

[Continuous](#)

[Auto Reset](#)

[Manual Reset](#)

The captured images saved in a folder are assigned a file number from 0001 to 9999. You can change how the image files are numbered.

(Example)
IMG_0001.JPG
|
(1)
(1) File number

1. Select [: File numbering].

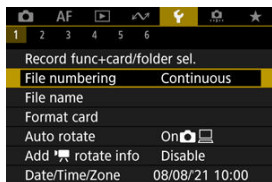

2. Set the item.

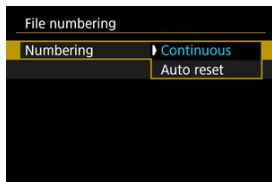

- Select [**Numbering**].
- Select [**Continuous**] or [**Auto reset**].

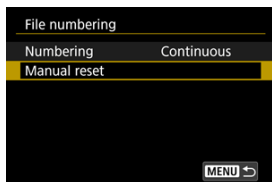

- If you want to reset the file numbering, select [**Manual reset**] (🔗).

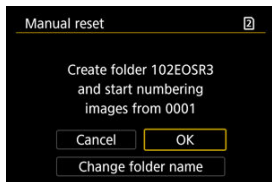

- Select [**OK**] to create a new folder, and the file number will start with 0001.

⚠ Caution

- If the file number in folder 999 reaches 9999, shooting will not be possible even if the card still has free space. After a message requesting you to replace the card is displayed, switch to a new card.

For continuous file numbering regardless of switching cards or creating folders

File numbering is continuous up to 9999, even if you replace a card, create a folder, or switch the target card (as in ①→②). This is useful when you want to save images numbered anywhere between 0001 to 9999 on multiple cards or in multiple folders into one folder on a computer.

Note that file numbering may continue from any existing images in cards or folders that you switch to. If you want to use continuous file numbering, it is recommended that you use a newly formatted card each time.

File numbering after replacing cards or switching target cards

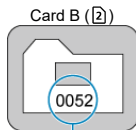
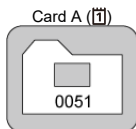

(1)

(1) Next sequential file number

File numbering after creating a folder

Card A

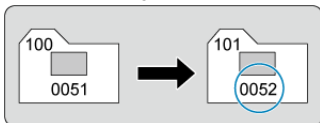

For restarting file numbering from 0001 after switching cards or creating folders

File numbering is reset to 0001 if you replace a card, create a folder, or switch the target card (as in **1**→**2**). This is useful if you want to organize images by cards or folders. Note that file numbering may continue from any existing images in cards or folders that you switch to. If you want to save images with the file numbering starting from 0001, use a newly formatted card each time.

File numbering after replacing cards or switching target cards

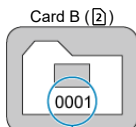
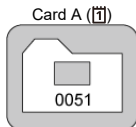

(1)

(1) File numbering is reset

File numbering after creating a folder

Card A

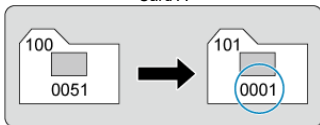

For resetting file numbering to 0001 or starting from 0001 in new folders

When you reset the file numbering manually, a new folder is created automatically and the file numbering of images saved to that folder starts from 0001.

This is useful, for example, if you want to use different folders for the images taken yesterday and the ones taken today.

File Naming

[Registering/Changing File Names](#)

File names consist of four alphanumeric characters followed by a four-digit file number  and file extension. You can change the first four alphanumeric characters, which by default are unique for each camera and set when the camera is shipped.

User setting 1 enables you to register four characters of your choice. User setting 2 adds three initial, registered characters of your choice to a fourth character representing the image size that is added automatically after you shoot.

(Example)
IMG_0001.JPG

Registering/Changing File Names

1. Select [: File name].

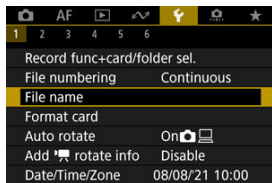

2. Select [Change User setting*].

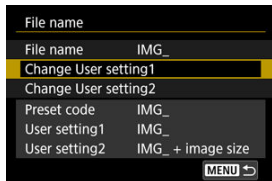



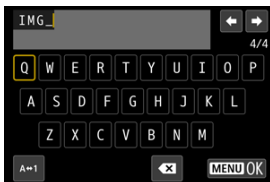

3. Enter letters and numbers of your choice.



- Enter four characters for User setting 1 or three for User setting 2.
- By selecting [**A⇌1**], you can change the input mode.
- To delete single characters, select [**X**] or press the  button.



- Use the  or  dial or  to select a character, then press  to enter it.

4. Exit the setting.

- Press the **<MENU>** button, then press **[OK]**.

5. Select a registered file name.

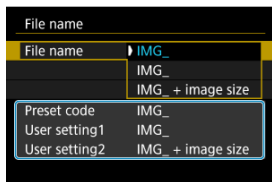

- Select [**File name**], then choose a registered file name.

⚠ Caution

- An underscore (“_”) cannot be used as the first character.

📄 Note

Notes on [User setting2]

- Shooting after you have selected “**** + image size” (as registered to User setting 2) will add a character representing the current image size to your file name as the fourth character. Meanings of added characters are as follows.

“***L”: L, L, RAW, or HEIF

“***M”: M or M

“***S”: S1 or S1

“***T”: S2

“***C”: CRAW

The automatically added fourth character enables you to determine image sizes without opening the files after transferring them to a computer. Based on file extensions, you can also distinguish RAW, JPEG, and HEIF images.

- Movies recorded with User setting 2 are named with the fourth character as an underscore.

Card Formatting

If the card is new or was previously formatted (initialized) by another camera or computer, format the card with this camera.

⚠ Caution

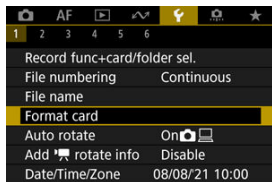

- When the card is formatted, all images and data on the card will be erased. Even protected images will be erased, so make sure there is nothing you need to keep. If necessary, transfer the images and data to a computer, etc. before formatting the card.

1. Select [: Format card].

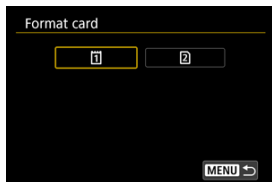

2. Select a card.



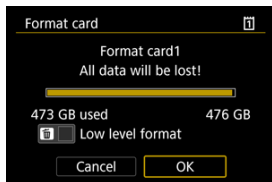

- [] represents card 1, and [], card 2.
- Select the card.

3. Format the card.

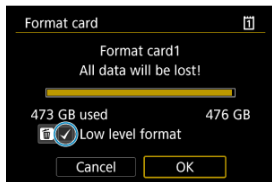

- Select **[OK]**.



- For low-level formatting, press the  button to add a checkmark [✓] to **[Low level format]**, then select **[OK]**.

Conditions requiring card formatting

- The card is new.
- The card was formatted by a different camera or a computer.
- The card is full of images or data.
- A card-related error is displayed ()

Low-level formatting

- Perform low-level formatting if the card's writing or reading speed seems slow or if you want to totally erase the data on the card.
- Since low-level formatting will format all recordable sectors on the card, the formatting will take longer than normal formatting.
- During low-level formatting, you can cancel formatting by selecting **[Cancel]**. Even in this case, normal formatting will already be complete and you can use the card as usual.

Card file formats

- CFexpress cards are exFAT formatted.
- SD cards are FAT16 or FAT12 formatted.
- SDHC cards are FAT32 formatted.
- SHXC cards are exFAT formatted.
- Individual movies recorded to exFAT-formatted cards are recorded as a single file (without splitting them into multiple files) even if they exceed 4 GB, so the resulting movie file will exceed 4 GB.

Caution

- It may not be possible to use cards formatted with this camera in other cameras. Also note that exFAT-formatted cards may not be recognized by some computer operating systems or card readers.
- Formatting or erasing data on a card does not completely erase the data. Be aware of this when selling or discarding the card. When disposing of cards, take steps to protect personal information if necessary, as by physically destroying cards.

Note

- The card capacity displayed on the card format screen may be smaller than the capacity indicated on the card.
- This device incorporates exFAT technology licensed from Microsoft.

Auto Rotate

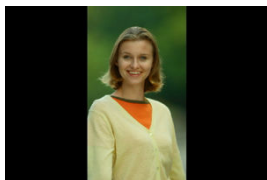

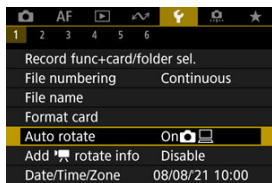

You can change the auto rotation setting that straightens images shot in vertical orientation when they are displayed.

1. Select [: Auto rotate].

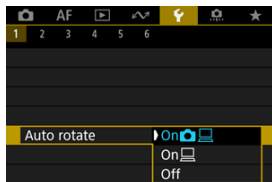

2. Select an option.



- **On** 
Automatically rotates images for display on both the camera and computers.
- **On** 
Automatically rotates images only for display on computers.
- **Off**
Images are not automatically rotated.

Caution

- Images captured with auto rotation set to **[Off]** will not rotate during playback even if you later set auto rotation to **[On]**.

Note

- If a picture is taken while the camera is aimed up or down, automatic rotation to the proper orientation for viewing may not be performed correctly.
- If images are not rotated automatically on a computer, try using EOS software.

Adding Orientation Information to Movies

For movies recorded with the camera held vertically, orientation information indicating which side is up can be added automatically to enable playback in the same orientation on smartphones or other devices.

1. Select [📷: Add 'rotate info].

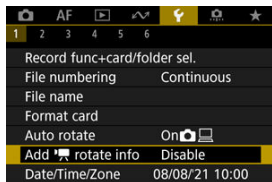

2. Select an option.

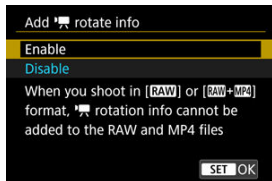

- **Enable**
Play movies on smartphones or other devices in the orientation in which they were recorded.
- **Disable**
Play movies horizontally on smartphones or other devices, regardless of the recording orientation.

 Caution

- [Add  rotate info] is not available for RAW or MP4 files when the movie recording format is **RAW** or **RAW+MP4**.
- Movies are played horizontally on the camera and via HDMI video output, regardless of this setting.

Date/Time/Zone

When you turn on the power for the first time or if the date/time/zone have been reset, follow these steps to set the time zone first.

By setting the time zone first, you can simply adjust this setting as needed in the future and the date/time will be updated to match it.

Since the captured images will be appended with the shooting date and time information, be sure to set your date/time.

1. Select [: Date/Time/Zone].

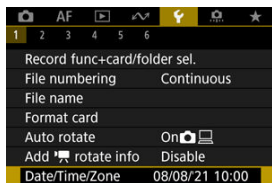

2. Set the time zone.

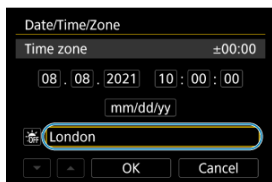

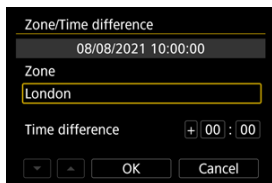

- Turn the <  > dial to select [Time zone].







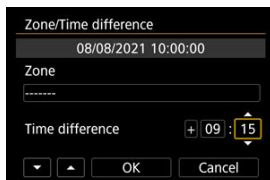

- Press <  >.







- Turn the <  > dial to select the time zone, then press <  >.
- If your time zone is not listed, press the < MENU > button, then set the difference from UTC in [Time difference].

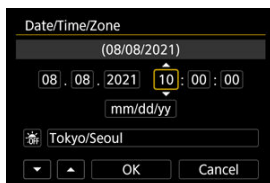

- Turn the <  > dial to select a [Time difference] option (+ / - / hour / minute), then press <  >.
- Set by turning the <  > dial, then press <  >.
- After entering the time zone or time difference, turn the <  > dial to select [OK], then press <  >.

3. Set the date and time.



- Turn the <  > dial to select an option, then press <  >.
- Set by turning the <  > dial, then press <  >.

4. Set daylight saving time.

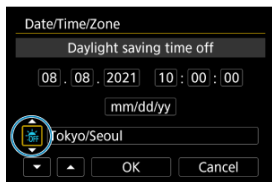

- Set it as necessary.
- Turn the < ☀ > dial to select [☀], then press < (SET) >.
- Turn the < ☀ > dial to select [☀], then press < (SET) >.
- When the daylight saving time is set to [☀], the time set in step 3 will advance by 1 hour. If [☀] is set, the daylight saving time will be canceled and the time will go back by 1 hour.

5. Exit the setting.

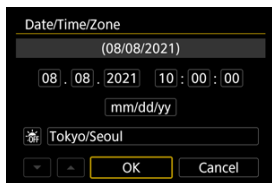

- Turn the < ☀ > dial to select [OK].

! Caution

- The date, time, and time zone settings may be reset when the camera is stored without the battery, when the battery is exhausted, or when it is exposed to freezing temperatures for an extended period. If this happens, set them once again.
- After changing [**Zone/Time difference**], check that the correct date/time are set.



Note

- Auto power off time may be extended while the [👉: **Date/Time/Zone**] screen is displayed.

Language

1. Select [: Language ].

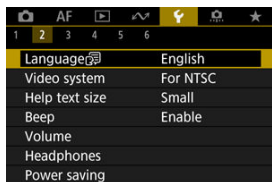

2. Set the desired language.



Video System

Set the video system of any television used for display. This setting determines the frame rates available when you record movies.

1. Select [: Video system].

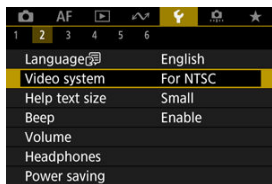

2. Select an option.

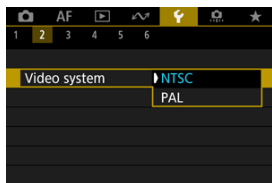

- **For NTSC**
For areas where the TV system is NTSC (North America, Japan, South Korea, Mexico, etc.).
- **For PAL**
For areas where the TV system is PAL (Europe, Russia, China, Australia, etc.).

Help

[Changing the Help Text Size](#)

When **[INFO Help]** is displayed, you can display a description of the feature by pressing the **<INFO>** button. Press it again to exit Help display. To scroll the screen when a scrollbar (1) appears on the right, turn the **<O>** dial.

● Example: [AF: Case 2]

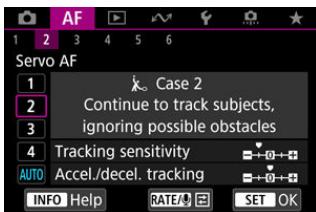

<INFO>

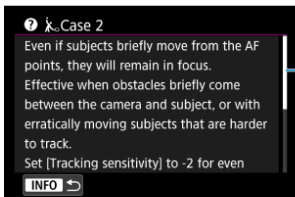

(1)

● Example: [🔒: Multi function lock]



<INFO>

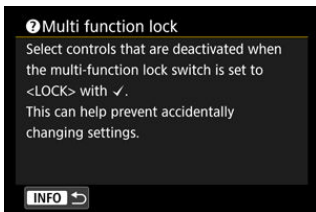

Changing the Help Text Size

1. Select [**F**: Help text size].

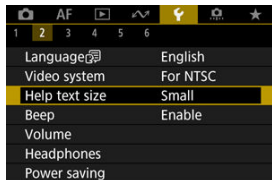

2. Select an option.

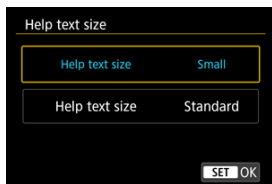

1. Select [🔊: Beep].

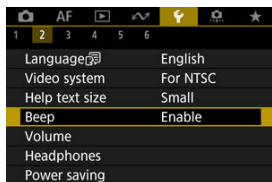

2. Select an option.

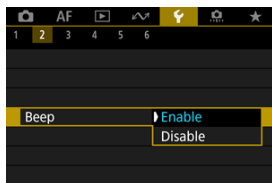

- **Enable**
The camera beeps after focusing and in response to touch operations.
- **Disable**
Disables beeping for focus confirmation, self-timer shooting, and touch operations.

Note

- By default, beeping volume for touch operations is set to [0] ().

Volume

The volume of camera sounds is adjustable.

1. Select [🔊: Volume].

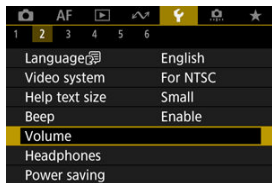

2. Set the option.

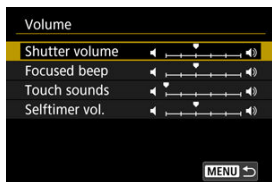

- Select an option, then turn the <🔊> dial to adjust the volume.

Note

- The camera always beeps, regardless of [📷: Shutter mode] settings, with [Always play at release] selected in [Shutter volume] settings.

Headphones

1. Select [: Headphones].

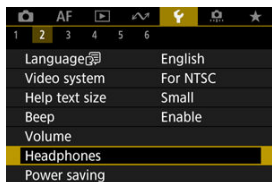

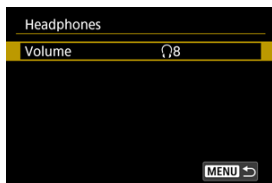

2. Select [Volume].



3. Adjust the volume.



- Turn the < > dial to adjust the volume, then press < >.



Note

- You can check sound from the built-in microphone or an external microphone on headphones when [📷: **Sound recording**] is set to an option other than [Disable] and [High Frame Rate] is set to [Disable].

Power Saving

You can adjust the timing of when the screen dims and then turns off, when the camera turns off, and when the viewfinder turns off after the camera is left idle (Screen dimmer, Screen off, Auto power off, and Viewfinder off).

1. Select [: Power saving].

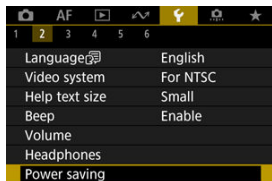

2. Select an option.

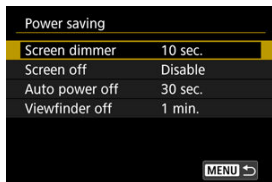

 **Note**

- **[Screen dimmer]** and **[Screen off]** apply while the shooting screen is displayed. These settings do not apply during menu display or image playback.
- The camera turns off during menu display or image playback after the time set in **[Screen dimmer]**, **[Screen off]**, and **[Auto power off]** elapses.
- To protect the screen, the camera turns off the screen 30 min. after it is dimmed (although the camera itself remains on), even if **[Screen off]** and **[Auto power off]** are set to **[Disable]**.
- **[Viewfinder off]** also applies while the screen is still on. After this time elapses, the viewfinder sensor is deactivated.
- Only **[Viewfinder off]** applies during viewfinder display. After this time elapses, the viewfinder sensor is deactivated and the viewfinder turns off.
- Images on the screen are displayed at a lower frame rate after the screen dims during still photo shooting standby.
- Auto power off does not take effect while the camera is connected via USB or Mobile File Transfer.

Screen and Viewfinder Display





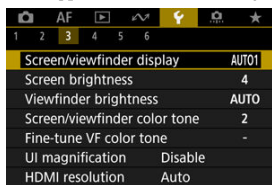

You can specify to use the screen or viewfinder for display, to avoid accidentally activating the viewfinder sensor when the screen is open.

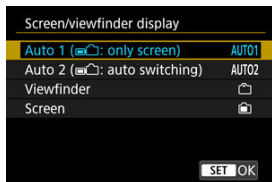
1. Select [: Screen/viewfinder display].



2. Select an option.



- **AUTO1: Auto 1** ( : only screen)
Always use the screen for display when it is open.
Use the screen for display when it is closed and facing you, and switch to the viewfinder when you look through it.
- **AUTO2: Auto 2** ( : auto switching)
Use the screen for display when it is closed and facing you, and switch to viewfinder display when you look through the viewfinder.
- : **Viewfinder**
Always use the viewfinder for display.
- : **Screen**
Always use the screen for display when it is open.



Note

- You can also switch between viewfinder and screen display by pressing a button you have customized by assigning to switching. With this setting set to **[AUTO1]** or **[AUTO2]**, the camera responds to the viewfinder sensor accordingly.
- With **[AUTO1]** set, the camera does not respond to the viewfinder sensor when the screen is open.

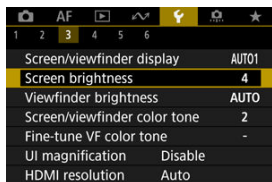

Screen Brightness

1. Select [: Screen brightness].

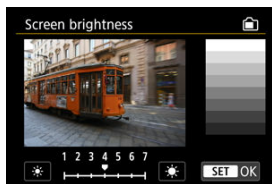

2. Make the adjustment.



- Referring to the gray image, turn the < > dial to adjust brightness, then press < >. Check the effect on the screen.

Note

- To check the image's exposure, referring to the histogram is recommended ().

Viewfinder Brightness

1. Select [: Viewfinder brightness].

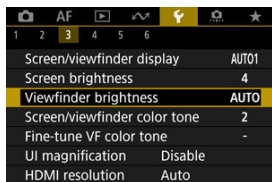

2. Turn the < > dial and select either [Auto] or [Manual].



Auto

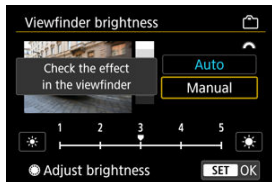

- Press < >. Check the effect in the viewfinder while shooting.

Manual



- Turn the < > dial to adjust viewfinder brightness, then press < >. Check the effect in the viewfinder.

Screen and Viewfinder Color Tone

1. Select [: Screen/viewfinder color tone].

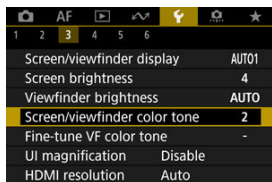

2. Make the adjustment.

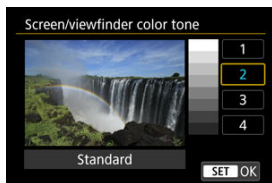

- Turn the < > dial to select an option, then press < >.

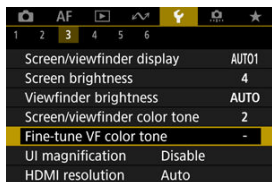

Fine-Tuning Viewfinder Color Tone

1. Select [: Fine-tune VF color tone].

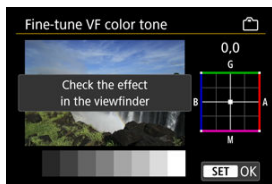

2. Make the adjustment.



- Referring to the gray image, use < > for adjustment, then press < >. Check the effect in the viewfinder.

UI Magnification

You can magnify menu screens by double-tapping with two fingers. Double-tap again to restore the original display size.

1. Select [: UI magnification].

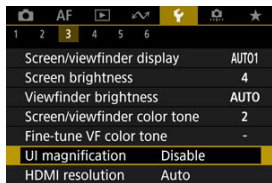

2. Select [Enable].

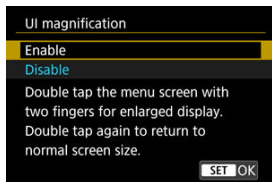

Caution

- Use camera controls when configuring menu functions with the display magnified. Touch-screen operations are not supported.

HDMI Resolution

Set the image output resolution used when the camera is connected to a television or external recording device with an HDMI cable.

1. Select [: HDMI resolution].

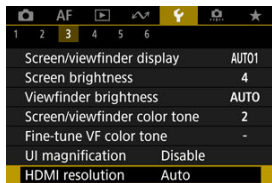

2. Select an option.

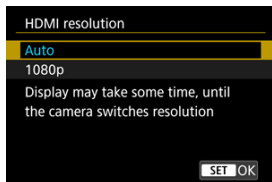

- **Auto**
The images will automatically be displayed at the optimum resolution matching the connected television.
- **1080p**
Output at 1080p resolution. Select if you prefer to avoid display or delay issues when the camera switches resolution.

Touch Control

1. Select [**T**: Touch control].

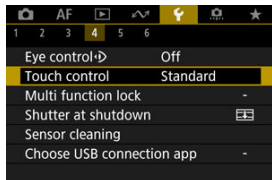

2. Select an option.



- [Sensitive] makes the touch-screen panel more responsive than [Standard].
- To disable touch operations, select [Disable].

⚠ Caution

Precautions for touch-screen panel operations

- Do not use sharp objects such as fingernails or ballpoint pens for touch operations.
- Do not use wet fingers for touch operations. If the screen has any moisture or if your fingers are wet, the touch-screen panel may not respond or malfunction may occur. In this case, turn off the power and wipe off the moisture with a cloth.
- Attaching a commercially available protective sheet or a sticker on the screen may impair responsiveness to touch operations.
- The camera may not respond as well if you quickly perform touch operation when [Sensitive] is set.

Multi-Function Lock

Specify camera controls to lock when the Multi-function lock is enabled. This can help prevent accidentally changing settings.

1. Select [: Multi function lock].

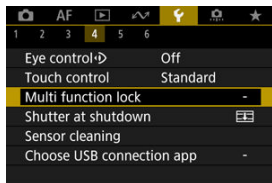

2. Select camera controls to lock.



- Press <  > to add a checkmark [✓].
- Select [OK].
- Setting the power/multi-function lock switch to < LOCK > locks the selected [✓] camera controls.

Note

- An asterisk "*" to the right of [: Multi function lock] indicates that the default setting has been modified.

Shutter at Shutdown

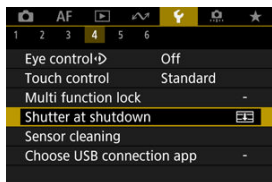

You can set whether to leave the shutter open or close it when the camera's power switch is set to <OFF>.

1. Select [: Shutter at shutdown].

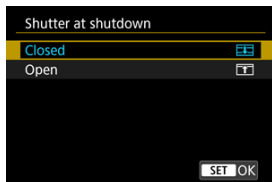

2. Select an option.



- : **Closed**
Closes the shutter. Normally set to closed, to prevent dust from adhering to the sensor when you switch lenses.
- : **Open**
Leaves the shutter open. This keeps camera quieter when the power switch is set to <ON> or <OFF>. Useful when you want to shoot quietly.

Note

- Regardless of the setting, the shutter remains as it is when auto power off is activated.

Sensor Cleaning

[Cleaning Now](#)

[Cleaning Automatically](#)

[Cleaning Manually](#)

The camera's sensor cleaning feature cleans the front of the image sensor.

Note

- For best results, clean with the camera in a stable position on a desk or other flat surface.

Cleaning Now

1. Select [: Sensor cleaning].

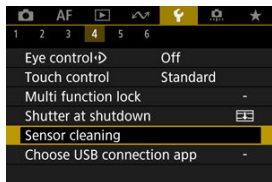

2. Select [Clean now.].

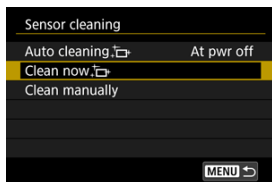

- Select [OK] on the confirmation screen.

Note

- Even if you repeat the sensor cleaning, the result will not improve much. Note that [Clean now.] may not be available immediately after cleaning.

1. Select [Auto cleaning, ].

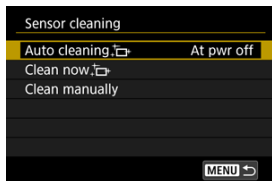

2. Select an option.

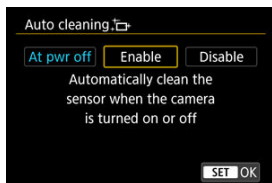

- Turn the <  > dial to select an option, then press <  >.

Note

- When set to [At pwr off] or [Enable], the sensor is cleaned when the screen goes off, including when it has been turned off automatically.

Cleaning Manually

Dust that could not be removed by automatic cleaning can be removed manually with a commercially available blower or similar tool.

Always use a fully charged battery.

The image sensor is extremely delicate. If the sensor needs to be cleaned directly, having it done by a Canon Service Center is recommended.

1. Select [Clean manually].

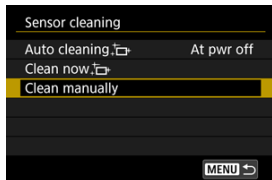

2. Select [OK].

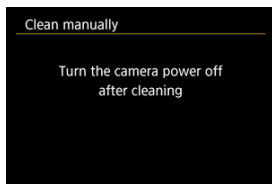
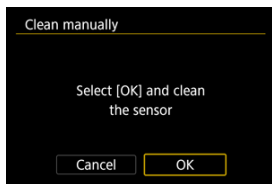

3. Remove the lens and clean the sensor.

4. End the cleaning.

- Set the power switch to < OFF >.



Note

- Using the household power outlet accessories (sold separately) is recommended.



Caution

- **While cleaning the sensor, never do any of the following. If the power is cut off, the shutter will close. These may result in damaging the image sensor and shutter curtains.**
 - **Setting the power switch to < OFF >.**
 - **Removing or inserting the battery.**
- The surface of the image sensor is extremely delicate. Clean the sensor with care.
- Use a plain blower without any brush attached. A brush can scratch the sensor.
- Do not insert the blower tip inside the camera beyond the lens mount. If the power is turned off, the shutter will close and the shutter curtains may get damaged.
- Never use pressurized air or gas to clean the sensor. Pressurized air may damage the sensor, and sprayed gas may freeze on the sensor and scratch it.
- If the battery level becomes low while cleaning the sensor, the beeper will sound as a warning. Stop cleaning the sensor.
- If a smudge that cannot be removed with a blower remains, having the sensor cleaned by a Canon Service Center is recommended.

App Selection for USB Connections

By connecting the camera to a smartphone or computer with the interface cable, you can transfer images or import images to the smartphone or computer.

1. Select [: Choose USB connection app].

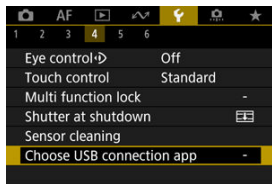

2. Select an option.

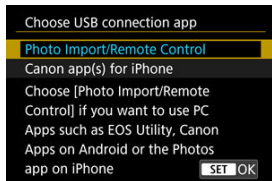

- **Photo Import/Remote Control**
Select if you will use EOS Utility after connecting to a computer, or if you will use dedicated Android apps or the iOS version of Photos.
- **Canon app(s) for iPhone**
Select if you will use dedicated iOS apps.
Connecting the camera to a smartphone requires a cable for this purpose. For details, refer to the instruction manual of the dedicated apps.

Resetting the Camera

The camera's settings for shooting functions and menu functions can be restored to their defaults.

1. Select [: Reset camera].

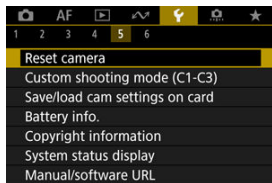

2. Select an option.

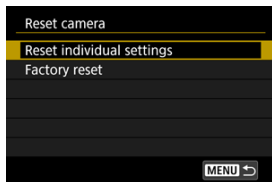

- **Reset individual settings**
Settings for individual selected options can be reset.
 - **Factory reset**
Resets all settings to defaults.
3. Clear the settings.

- Select [**OK**] on the confirmation screen.



Note

- Still photo Custom shooting modes are reset when [**Custom shooting mode (C1-C3)**] in [**Reset individual settings**] is selected in still photo shooting mode, and movie Custom shooting modes are reset when this option is selected in movie recording mode.

Custom Shooting Mode (C1–C3)

[Automatic Update of Registered Settings](#)

[Canceling Registered Custom Shooting Modes](#)

Current camera settings such as shooting, menu, and Custom Function settings can be registered in Custom shooting modes [C1_p] to [C3_p]. You can register different functions to use when shooting still photos or movies.

1. Select [**F**: Custom shooting mode (C1-C3)].

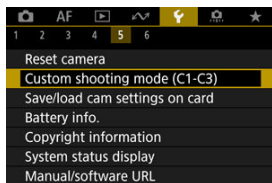

2. Select [Register settings].

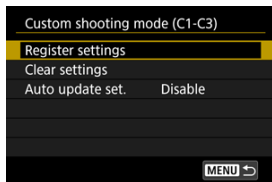

3. Register the desired items.

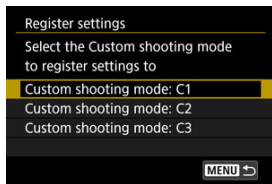

- Select the Custom shooting mode to register, then select **[OK]** on the **[Register settings]** screen.
- The current camera settings are registered to Custom shooting mode C*.

Caution

- Depending on the menu items, setting options changed in other shooting modes may not be carried over to the Custom shooting mode settings.

Automatic Update of Registered Settings

If you change a setting while shooting in Custom shooting mode, the mode can be automatically updated with the new setting (Auto update). To enable this automatic update, set **[Auto update set.]** to **[Enable]** in step 2.

Canceling Registered Custom Shooting Modes

If you select **[Clear settings]** in step 2, the settings of each mode can be restored to default settings, as they were before registration.



Note

- You can also change shooting and menu settings in Custom shooting modes.

Save/Load Camera Settings on Card

 [Saving Camera Settings](#)

 [Loading Camera Settings](#)

Current camera settings such as shooting, menu, and Custom Function settings can be saved to a card as a camera settings file. By loading a camera settings file, you can apply the state of the settings as saved. This enables you to save and apply optimal settings for specific shooting situations, or load settings files on other EOS R3 cameras to use the cameras with the same settings.

Saving Camera Settings

1. Select [: Save/load cam settings on card].

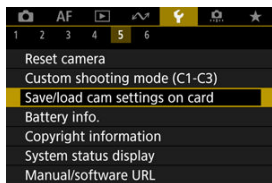

2. Select [Save to card].

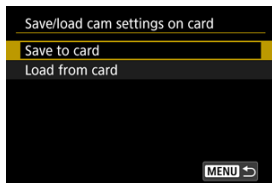

3. Select [OK].

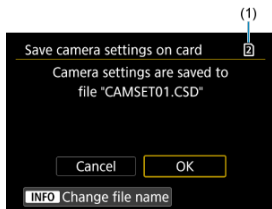

(1) Target card

- The camera settings are saved to the card.

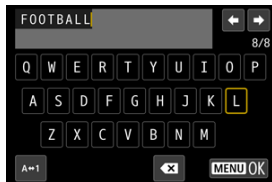

- To rename the file to an 8-character name of your choice before saving it, press the <INFO> button on the screen in step 3.
- For instructions, see [File Naming](#). The steps are the same.

! Caution

- Camera settings files saved by a camera other than an EOS R3 cannot be loaded on this camera.
- It may not be possible to load camera settings files that were saved by a camera with a different firmware version.

📄 Note

- Up to ten camera settings files can be saved on a card. If a card already has ten camera settings files, either overwrite existing files or use a different card.

Loading Camera Settings

In step 2 of [Saving Camera Settings](#), select [**Load from card**] to display up to ten camera settings files on the card. Select a file, and the camera will load it and apply the state of the settings as saved.

Battery Information

You can check the conditions of the battery you are using.

1. Select [🔋: Battery info.].

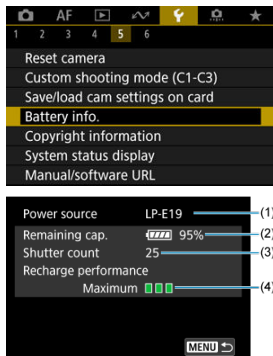

- (1) Model of battery or household power source used.
- (2) Battery level indicator (🔋) with the remaining battery level, in 1% increments.
- (3) The number of shots taken with the current battery. The number is reset when the battery is charged.
- (4) State of battery recharge performance, in three levels.
 - ■ ■ (Green): Battery recharge performance is good.
 - ■ □ (Green): Battery recharge performance is slightly degraded.
 - □ □ (Red): Purchasing a new battery is recommended.

⚠ Caution

- Using a genuine Canon Battery Pack LP-E19 is recommended. If you use batteries that are not genuine Canon products, the camera's full performance may not be attained or malfunction may result.



Note

- The shutter count is the number of still photos taken (not including movie recording).
- If a battery communication error message is displayed, follow the instructions in the message.

Copyright Information

 [Checking the Copyright Information](#)

 [Deleting the Copyright Information](#)

When you set the copyright information, it will be recorded to the image as Exif information.

Caution

- If the entry for “Author” or “Copyright” is long, it may not be displayed entirely when you select **[Display copyright info.]**.

Note

- You can also set or check copyright information with EOS Utility (EOS software, ).

1. Select [: Copyright information].

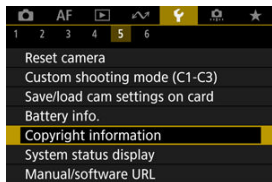





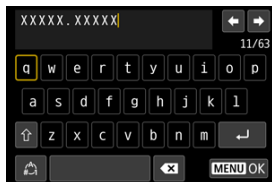

2. Select an option.



3. Enter text.



- Use the <  > or <  > dial or <  > to select a character, then press <  > to enter it.
- By selecting [], you can change the input mode.
- To delete single characters, select [] or press the <  > button.

4. Exit the setting.

- Press the < MENU > button, then press [OK].

Checking the Copyright Information

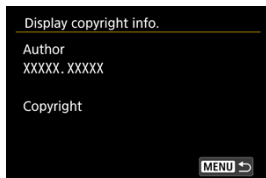

When you select [**Display copyright info.**] in step 2, you can check the [**Author**] and [**Copyright**] information that you entered.

Deleting the Copyright Information

When you select **[Delete copyright information]** in step 2, you can delete the **[Author]** and **[Copyright]** information.

System Status Display

 [Checking the Error Log](#)

 [Clearing the Camera Status Log](#)

You can check the camera's serial number, firmware version, and shutter-release cycles on this screen. You can also check the status log for past errors.

Checking camera status with this feature and requesting any required maintenance at a Canon Service Center can reduce camera problems.

Checking the Error Log

You can check a record of past errors, as well as lens, flash, and battery usage at the time of occurrence.

1. Select [: System status display].

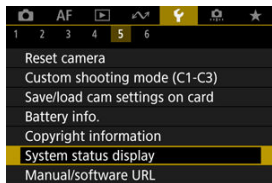

2. Check the details as needed.

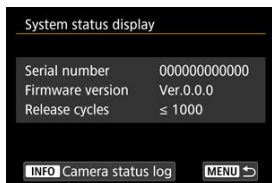

Note

- The camera status log screen lists as many as five recent error records. Older records are automatically deleted.
- Shutter-release cycles are indicated in units of 1,000.
- Electronic shutter release is not included in the number of shutter-release cycles.

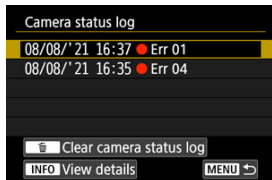

3. Check the log as needed.

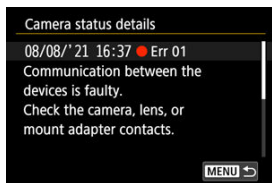

- On the screen in step 2, press the < INFO > button.
- “Err ***” indicates error information (🔗).

4. Check the details as needed.



- Turn the <  > dial to select an item, then press the < INFO > button to view error details.
- Turn the <  > dial to check details.

Clearing the Camera Status Log

To clear all log information displayed, press the <  > button in step 3 of [Checking the Error Log](#).

Other Information

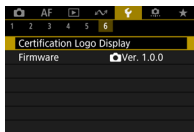
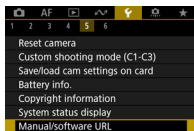

- **Manual/software URL**

To download instruction manuals, select [**📄: Manual/software URL**] and scan the displayed QR code with a smartphone. You can also use a computer to access the website at the URL displayed and download software.

- **Certification Logo Display**

Select [**📄: Certification Logo Display**] to display some of the logos of the camera's certifications. Other certification logos can be found on the camera body and packaging.

- **Firmware**

Select [**📄: Firmware**] to update the firmware of the camera, lens, or other compatible accessories in use.

Custom Functions/My Menu

You can fine-tune camera functions and change the functionality of buttons and dials to suit your shooting preferences. You can also add menu items and Custom Functions that you adjust frequently to My Menu tabs.

- [Tab Menus: Custom Functions](#)
- [Custom Function Setting Items](#)
- [Tab Menus: My Menu](#)
- [Registering My Menu](#)

Tab Menus: Custom Functions

● Custom Functions 1

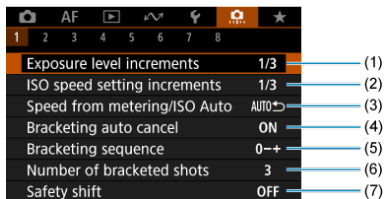

- (1) [Exposure level increments](#)
- (2) [ISO speed setting increments](#)
- (3) [Speed from metering/ISO Auto](#)
- (4) [Bracketing auto cancel](#)
- (5) [Bracketing sequence](#)
- (6) [Number of bracketed shots](#)
- (7) [Safety shift](#)

● Custom Functions 2

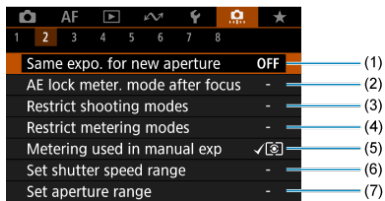

- (1) [Same expo. for new aperture](#)
- (2) [AE lock meter. mode after focus](#)
- (3) [Restrict shooting modes](#)
- (4) [Restrict metering modes](#)
- (5) [Metering used in manual exp](#)
- (6) [Set shutter speed range](#)
- (7) [Set aperture range](#)

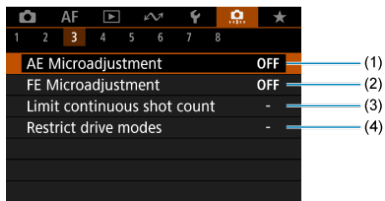

● Custom Functions 3

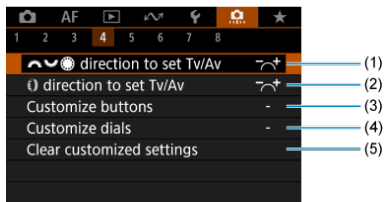

- (1) [AE Microadjustment](#)
- (2) [FE Microadjustment](#)
- (3) [Limit continuous shot count](#)
- (4) [Restrict drive modes](#)

● Custom Functions 4



- (1)  [direction to set Tv/Av](#)
- (2)  [direction to set Tv/Av](#)
- (3) [Customize buttons](#)
- (4) [Customize dials](#)
- (5) [Clear customized settings](#)

● Custom Functions 5

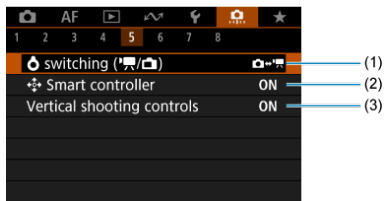

- (1) [switching \(*//\)](#)
- (2) [Smart controller](#)
- (3) [Vertical shooting controls](#)

● Custom Functions 6

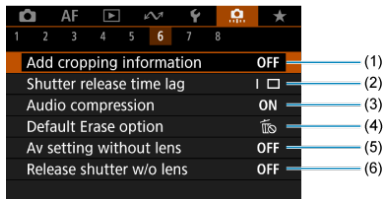

- (1) [Add cropping information](#)
- (2) [Shutter release time lag](#)
- (3) [Audio compression](#)
- (4) [Default Erase option](#)
- (5) [Av setting without lens](#)
- (6) [Release shutter w/o lens](#)

● Custom Functions 7

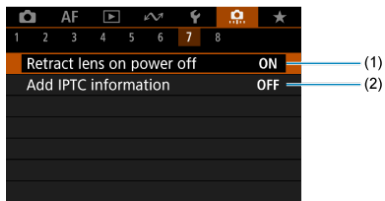

(1) [Retract lens on power off](#)

(2) [Add IPTC information](#)

● Custom Functions 8

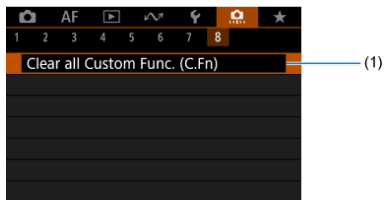

(1) [Clear all Custom Func. \(C.Fn\)](#)

Selecting [: **Clear all Custom Func. (C.Fn)**] clears all Custom Function settings.

Custom Function Setting Items

  [1]

  [2]

  [3]

  [4]

  [5]

  [6]

  [7]

  [8]

You can customize camera features on the  tab to suit your shooting preferences. Any settings you change from default values are displayed in blue.

Exposure level increments

You can specify to use 1/2-stop increments as the increments for shutter speed, aperture value, exposure compensation, AEB, flash exposure compensation, and FEB.

- 1/3: 1/3-stop
- 1/2: 1/2-stop

Note

- Display when set to [1/2-stop] is as follows.



ISO speed setting increments

You can change the manual ISO speed setting increment to a whole stop.



- 1/3: 1/3-stop
- 1/1: 1-stop

Note

- Even if [1-stop] is set, ISO speed will be automatically set in 1/3-stop increments when ISO Auto is set.

Speed from metering/ISO Auto

You can set the ISO speed status after the metering timer ends in cases where, for ISO Auto operation in [P]/[Tv]/[Av]/[M]/[BULB] mode, the camera has adjusted the ISO speed during metering or during the metering timer.

- **AUTO** : Restore Auto after metering
- **AUTO** : Retain speed after metering

Bracketing auto cancel

You can specify to cancel AEB and white balance bracketing when the power switch is set to <OFF>.

- **ON**: Enable
- **OFF**: Disable

Bracketing sequence

The AEB shooting sequence and white balance bracketing sequence can be changed.

- **0-+**: 0, -, +
- **-0+**: -, 0, +
- **+0-**: +, 0, -

AEB	White Balance Bracketing	
	B/A Direction	M/G Direction
0: Standard exposure	0: Standard white balance	0: Standard white balance
-: Underexposure	-: Blue bias	-: Magenta bias
+: Overexposure	+: Amber bias	+: Green bias

Number of bracketed shots

The number of shots taken with AEB and white balance bracketing can be changed. When **[Bracketing sequence]** is set to **[0, -, +]**, the bracketed shots will be taken as shown in the following table.

- **3: 3 shots**
- **2: 2 shots**
- **5: 5 shots**
- **7: 7 shots**

(1-stop/step increments)

	1st Shot	2nd Shot	3rd Shot	4th Shot	5th Shot	6th Shot	7th Shot
3: 3 shots	Standard (0)	-1	+1				
2: 2 shots	Standard (0)	±1					
5: 5 shots	Standard (0)	-2	-1	+1	+2		
7: 7 shots	Standard (0)	-3	-2	-1	+1	+2	+3

Note



- If **[2 shots]** is set, you can select the + or - side when setting the AEB range. With white balance bracketing, the second shot is adjusted toward the negative side for the B/A or M/G direction.

Safety shift

If the subject brightness changes and the standard exposure cannot be obtained within the autoexposure range, the camera will automatically change the manually selected setting to obtain the standard exposure. **[Shutter speed/Aperture]** applies to **[Tv]** or **[Av]** mode. **[ISO speed]** applies to **[P]**, **[Tv]**, or **[Av]** mode.

- **OFF: Disable**
- **Tv/Av: Shutter speed/Aperture**
- **ISO: ISO speed**

Note

- Safety shift overrides any changes to **[ISO speed range]** or **[Min. shutter spd.]** from default settings in :  **ISO speed settings** if standard exposure cannot be obtained.
- The minimum and maximum limits for the safety shift with the ISO speed are determined by **[Auto range]** . However, if the manually set ISO speed exceeds the **[Auto range]**, the safety shift will take effect up or down to the manually set ISO speed.
- Safety shift will take effect as necessary even when flash is used.

Same expo. for new aperture

The maximum aperture value may decrease (the lowest f/number may increase) in **[M]** mode (manual exposure shooting) with ISO speed set manually (except when set to ISO Auto) if you (1) Change lenses, (2) Attach an extender, or (3) Use a zoom lens with a variable maximum aperture value. This function prevents the corresponding underexposure by adjusting ISO speed or shutter speed (Tv value) automatically to maintain the same exposure as before (1), (2), or (3).

With **[ISO speed/Shutter speed]**, the ISO speed is automatically adjusted within the ISO speed range. If exposure cannot be maintained by adjusting ISO speed, shutter speed (Tv value) is automatically adjusted.

- **OFF: Disable**
- **ISO: ISO speed**
- **ISO/Tv: ISO speed/Shutter speed**
- **Tv: Shutter speed**

Caution

- Does not respond to changes in effective aperture value from changes in magnification when macro lenses are used.
- Cannot provide the same exposure as before (1), (2), or (3) if **[ISO speed]** is set and the exposure cannot be maintained at speeds set in **[ISO speed range]**.
- Cannot provide the same exposure as before (1), (2), or (3) if **[Shutter speed]** is set and the exposure cannot be maintained at speeds set in **[: Set shutter speed range]**.
- Shutter speed is limited to 1/8000 when **[: Shutter mode]** is **[Electronic]** and **[Same expo. for new aperture]** is set to **[Shutter speed]** or **[ISO speed/Shutter speed]**.

Note

- Also responds to changes in the highest f/number (minimum aperture).
- The original exposure setting is restored if you perform (1), (2), or (3) with **[ISO speed]**, **[ISO speed/Shutter speed]**, or **[Shutter speed]** set and do not adjust ISO speed, shutter speed, or aperture value before returning the camera to the original state, before (1), (2), or (3).
- Shutter speed may change to maintain exposure if the ISO speed increases to an expanded ISO speed when **[ISO speed]** is set.

AE lock meter. mode after focus

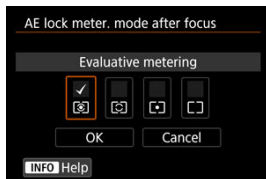

For each metering mode, you can specify whether to lock the exposure (AE lock) once subjects are in focus with One-Shot AF. The exposure will be locked while you keep pressing the shutter button halfway. Select metering modes for AE lock and add a checkmark [✓]. Select [OK] to register the setting.

Restrict shooting modes

You can restrict the shooting modes available with the <MODE> button. Select available shooting modes [Fv / P / Av / M / Tv / BULB / C1 / C2 / C3], then press <SET> to add a checkmark [✓]. Select [OK] to register the setting.

Caution

- Restricted shooting mode settings are not registered to [C1P], [C2P], or [C3P].
- The [✓] mark cannot be cleared from all nine modes at the same time.

Restrict metering modes

You can restrict the metering modes available with the > button.

Select available metering modes [/ / / , then press > to add a checkmark . Select **[OK]** to register the setting.

Caution

- The mark cannot be cleared from all four modes at the same time.

Metering used in manual exp

You can set the metering mode used in **[M]** shooting mode.

- : **Specified metering mode**
The current metering mode is used.
- : **Evaluative metering**
- : **Partial metering**
- : **Spot metering**
- : **Center-weighted average**

Caution

- Setting [/ / /] will prevent you from selecting the metering mode by pressing the > button in manual exposure shooting.

Set shutter speed range

You can set the shutter speed range for each [: **Shutter mode**] option. In [**Fv**], [**Tv**], or [**M**] mode, you can set the shutter speed manually within your specified range. In [**P**] and [**Av**] mode, or in [**Fv**] mode with shutter speed set to [**AUTO**], the shutter speed is set automatically within your specified range (except for movie recording). Select [**OK**] to register the setting.

- **Mech shutter/elec 1st-curtain**

- **Lowest speed:** Can be set in a range of 30 sec.–1/4000 sec.
- **Highest speed:** Can be set in a range of 1/8000 sec.–15 sec.

- **Electronic**

- **Lowest speed:** Can be set in a range of 30 sec.–1/32000 sec.
- **Highest speed:** Can be set in a range of 1/64000 sec.–15 sec.

Caution

- Setting [**Highest speed**] for [**Electronic**] to 1/64000 will not limit highest speeds faster than 1/8000 in [**P**] or [**Av**] mode.
- This setting does not apply to HF anti-flicker shooting.

Set aperture range

You can set the aperture value range. In [**Fv**], [**Av**], [**M**], or [**BULB**] mode, you can set the aperture value manually within your specified range. In [**P**] and [**Tv**] mode, or in [**Fv**] mode with the aperture value set to [**AUTO**], the aperture value is set automatically within your specified range. Select [**OK**] to register the setting.

- **Max. aperture**

Can be set in a range of f/1.0–f/64.

- **Min. aperture**

Can be set in a range of f/91–f/1.4.

Note

- The available aperture value range varies depending on the lens's minimum and maximum aperture value.

AE Microadjustment

Caution

- Normally, this adjustment is not required. Perform this adjustment only if necessary. Note that performing this adjustment may prevent you from obtaining suitable exposure.

You can fine-tune the standard exposure level. Effective if images in autoexposure shooting without exposure compensation usually seem underexposed or overexposed.

- **OFF: Disable**
- **ON: Enable**

To access the adjustment screen, select **[Enable]**, then press the < **[Q]** > button.

Standard exposure can be adjusted in a range of ± 1 stop, in 1/8-stop increments. Set on the positive side if shots tend to be underexposed and on the negative side if they tend to be overexposed.

Caution

- The effective exposure compensation range available in movie recording remains unchanged if you adjust standard exposure with AE Microadjustment, and only the standard exposure level is changed. An exposure compensation amount equivalent to the AE Microadjustment amount is not applied to resulting images if the effective exposure compensation range in movie recording is exceeded (for example, an exposure compensation amount of +1 stop is not applied if AE Microadjustment is set to +1 stop and exposure compensation to +3 stops).

Note

- Exposure compensation can be set up to ± 3 stops from the adjusted standard exposure when shooting.

FE Microadjustment

! Caution

- **Normally, this adjustment is not required. Perform this adjustment only if necessary. Note that performing this adjustment may prevent you from obtaining suitable flash exposure.**

You can fine-tune the standard flash exposure level. Effective if main subjects in autoflash shooting without flash exposure compensation usually seem underexposed or overexposed.

- **OFF: Disable**
- **ON: Enable**

To access the adjustment screen, select **[Enable]**, then press the **< Q >** button. Standard flash exposure can be adjusted in a range of ± 1 stop, in 1/8-stop increments. Set on the positive side if main subjects tend to be underexposed and on the negative side if they tend to be overexposed.

Limit continuous shot count

You can limit the maximum burst for continuous shooting, so that while you keep holding down the shutter button with continuous shooting set, the camera automatically stops shooting after the specified number of continuous shots.

You can set it from 99 to 2 exposures. Pressing the **< 1/100 >** button returns the setting to **[Disable]**.

When **[Disable]** is set, continuous shooting can continue up to the maximum burst shown at right in the viewfinder.

Restrict drive modes









You can restrict the drive modes available with the **< DRIVE•AF >** button.





Select available drive modes **[] / [] / [] / [] / [] / [] / [] / []**, then press **< (SET) >** to add a checkmark **[✓]**. Select **[OK]** to register the setting.

! Caution

- The **[✓]** mark cannot be cleared from all modes at the same time.





 direction to set Tv/Av

Dial turning direction when setting the shutter speed and aperture value can be reversed. Reverses the turning direction of the <  >, <  >, and <  > dial in [M] shooting mode and only the <  > dial in other shooting modes. The direction of the <  > and <  > dial in [M] mode matches the direction to set exposure compensation with the <  > and <  > dials in [P], [Tv], and [Av] modes.

-  : Normal
-  : Reverse direction

 direction to set Tv/Av

RF lens and mount adapter control ring turning direction when setting the shutter speed and aperture value can be reversed.

-  : Normal
-  : Reverse direction

Customize buttons

You can assign frequently used functions to camera buttons that are easy for you to use. Different functions, for use when shooting still photos or movies, can be assigned to the same button.

1. Select [CUSTOMIZE: Customize buttons].

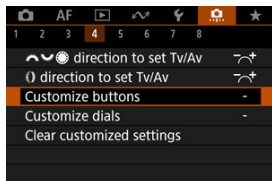

2. Select a camera control.



3. Select a function to assign.



- Press < **SET** > to set it.
- You can configure advanced settings for functions labeled with **[INFO]** in the lower left of the screen by pressing the < **INFO** > button.



Note











- [F6]: **Customize buttons**] settings are not cleared even if you select [F6]: **Clear all Custom Func. (C.Fn)**]. To clear the settings, select [F6]: **Clear customized settings**].

Functions available for customization

AF

●: Default ○: Available for customization

Function			MODE	AF-ON	AF-ON		EB		L-Fn	M-Fn	M-Fn2		SET	
 Start/stop tracking				○		○	○	○	○	○	●		○	
 Metering and AF start	○			●		○	○	○	○		○			
AF-OFF AF stop		○	○	○		○	○	○	●	○	○	○		
 AF point selection		○	○	○		○	●	○	○	○	○	○	○	
 Direct AF point selection					○									●
 Direct AF pt sel (during meter)					○									
 Set AF point to center		○	○	○		○	○	○	○	○	○	○	● ^{*3}	
 Switch to registered AF point ^{*1}				○		○	○	○	○		○			
AF-- Switch to registered AF func. ^{*1}				○		○	○	○	○		○			
 Direct AF area selection ^{*1}		○	○	○		○	○	○	○	○	○	○	○	

 One-Shot AF Servo AF ^{*1}			<input type="checkbox"/>	<input type="checkbox"/>	<input type="checkbox"/>		<input type="checkbox"/>	<input type="checkbox"/>	<input type="checkbox"/>	<input type="checkbox"/>	<input type="checkbox"/>	<input type="checkbox"/>	<input type="checkbox"/>	
 Move AF point by eye control ^{*1}					<input type="checkbox"/>		<input type="checkbox"/>	<input type="checkbox"/>	<input type="checkbox"/>	<input type="checkbox"/>		<input type="checkbox"/>		
 Moving AF point, start AF by eye ctrl ^{*1}					<input type="checkbox"/>		<input type="checkbox"/>	<input type="checkbox"/>	<input type="checkbox"/>	<input type="checkbox"/>		<input type="checkbox"/>		
 Eye control ^{*1}		<input type="checkbox"/>	<input type="checkbox"/>	<input type="checkbox"/>		<input type="checkbox"/>	<input type="checkbox"/>	<input type="checkbox"/>	<input type="checkbox"/>	<input type="checkbox"/>	<input type="checkbox"/>	<input type="checkbox"/>	<input type="checkbox"/>	<input checked="" type="checkbox"/> ^{*4}
 Moving AF pt, meter., AF by eye ctrl ^{*1}	<input checked="" type="checkbox"/>													
 Eye Detection AF ^{*1}				<input type="checkbox"/>		<input type="checkbox"/>	<input type="checkbox"/>	<input type="checkbox"/>	<input type="checkbox"/>		<input type="checkbox"/>			
 Eye detection		<input type="checkbox"/>	<input type="checkbox"/>	<input type="checkbox"/>		<input type="checkbox"/>	<input type="checkbox"/>	<input type="checkbox"/>	<input type="checkbox"/>	<input type="checkbox"/>	<input type="checkbox"/>	<input type="checkbox"/>	<input type="checkbox"/>	
 Focus mode		<input type="checkbox"/>	<input type="checkbox"/>	<input type="checkbox"/>		<input type="checkbox"/>	<input type="checkbox"/>	<input type="checkbox"/>	<input type="checkbox"/>	<input type="checkbox"/>	<input type="checkbox"/>	<input type="checkbox"/>	<input type="checkbox"/>	
PEAK Peaking		<input type="checkbox"/>	<input type="checkbox"/>	<input type="checkbox"/>		<input type="checkbox"/>	<input type="checkbox"/>	<input type="checkbox"/>	<input type="checkbox"/>	<input type="checkbox"/>	<input type="checkbox"/>	<input type="checkbox"/>	<input type="checkbox"/>	
 Focus guide		<input type="checkbox"/>	<input type="checkbox"/>	<input type="checkbox"/>		<input type="checkbox"/>	<input type="checkbox"/>	<input type="checkbox"/>	<input type="checkbox"/>	<input type="checkbox"/>	<input type="checkbox"/>	<input type="checkbox"/>	<input type="checkbox"/>	
 Drive mode ^{*1}		<input type="checkbox"/>	<input type="checkbox"/>	<input type="checkbox"/>		<input type="checkbox"/>	<input type="checkbox"/>	<input type="checkbox"/>	<input type="checkbox"/>	<input type="checkbox"/>	<input type="checkbox"/>	<input type="checkbox"/>	<input type="checkbox"/>	

* 1: Cannot be assigned as a function available in movie recording.



* 3: Default in movie recording.

* 4: Default in still photo shooting.

Exposure Compensation

●: Default ○: Available for customization

Function			MODE	AF-ON	MF		EB		L-Fn	M-Fn	M-Fn2		SET	
AF-OFF AE lock, AF stop		○	○	○		○	○	○	○	○	○	○		
 Metering start	○			○										
 AE lock		○	○	○		○	○	○	○	○	○	○		
H AE lock (hold)		○	○	○		● ^{*3}	○	○	○	○	○	○		
 AE lock (while button pressed) ^{*1}	○													
 AE lock/FE lock ^{*1}		○	○	○		● ^{*4}	○	○	○	○	○	○		
OFF Release AE Lock		○	○	○		○	○	○	○	○	○	○		
 Expo comp (hold btn, turn)				○		○	○	○	○		○		○	
ISO ISO speed		○	○	○		○	○	○	○	○	○	○	○	

ISO  Set ISO speed(hold btn,turn )				○		○	○	○	○		○		○	
 Flash firing* ¹		○	○	○		○	○	○	○	○	○	○	○	
FEL FE lock* ¹		○	○	○		○	○	○	○	○	○	○		

* 1: Cannot be assigned as a function available in movie recording.

* 3: Default in movie recording.

* 4: Default in still photo shooting.

Image

●: Default ○: Available for customization

Function			MODE	AF-ON	MF-ON		BB		L-Fn	M-Fn	M-Fn2		SET	
 Image size selection ^{*1}		○	○	○		○	○	○	○	○	○	○	○	
 One-touch image quality setting ^{*1}		○	○	○		○	○	○	○	○	○	○	○	
 One-touch image quality (hold) ^{*1}		○	○	○		○	○	○	○	○	○	○	○	
 Cropping/aspect ratio ^{*1}		○	○	○		○	○	○	○	○	○	○	○	
 Auto Lighting Optimizer		○	○	○		○	○	○	○	○	○	○	○	
WB White balance		○	○	○		○	○	○	○	○	○	○	○	
 Picture Style		○	○	○		○	○	○	○	○	○	○	○	
 Protect		○	○	○		○	○	○	○	○	○	○		
 Rating		○	○	○		○	○	○	○	○	○	○		
 Record func +card/folder sel.		○	○	○		○	○	○	○	○	○	○	○	

* 1: Cannot be assigned as a function available in movie recording.

Movies









●: Default ○: Available for customization













Function			MODE	AF-ON	MFN		BB		L-Fn	M-Fn	M-Fn2		SET	
 Zebra*2			○	○		○	○	○	○	○	○	○	○	
 Movie recording		●	○	○		○		○	○	○	○	○		
 Pause Movie Servo AF*2		○	○	○		○	○	○	○	○	○	○	○	

* 2: Cannot be assigned as a function available in still photo shooting.

●: Default ○: Available for customization

Function			MODE	AF-ON	AF-ON		EB		L-Fn	M-Fn	M-Fn2		SET	
 Flash function settings ^{*1}		○	○	○		○	○	○	○	○	○	○	○	
DIAL FUNC Dial function settings		○	○	○		○	○	○	○	●	○	○	○	
 Cycle between the set functions		○	○	○		○	○	○	○	○	○			
 Short press: LCD illumination Long press: LCD info switching												○		
 Short press: LCD info switching Long press: LCD illumination												●		
 LCD panel illumination		○	○	○		○	○	○	○	○	○	○		
 LCD panel info switching		○	○	○		○	○	○	○	○	○	○		
MODE Shooting mode settings		○	●	○		○	○	○	○	○	○	○		
 Manual HF anti-flicker shoot(Tv)		○	○	○		○	○	○	○	○	○	○	○	
 Silent shutter function ^{*1}		○	○	○		○	○	○	○	○	○	○		

			<input type="radio"/>	<input type="radio"/>	<input type="radio"/>		<input type="radio"/>	<input type="radio"/>	<input type="radio"/>	<input type="radio"/>	<input type="radio"/>	<input type="radio"/>	<input type="radio"/>	
Switch focus/ control ring														
C										<input type="radio"/>				
Switch to Custom shooting mode														
			<input type="radio"/>	<input type="radio"/>	<input type="radio"/>		<input type="radio"/>	<input type="radio"/>	<input type="radio"/>	<input type="radio"/>	<input type="radio"/>	<input type="radio"/>	<input type="radio"/>	
Depth-of- field preview* ¹								<input checked="" type="radio"/>						
AUTO			<input type="radio"/>	<input type="radio"/>	<input type="radio"/>		<input type="radio"/>	<input type="radio"/>	<input type="radio"/>	<input type="radio"/>	<input type="radio"/>	<input type="radio"/>	<input type="radio"/>	
Reset selected item in Fv mode* ¹														
			<input type="radio"/>	<input type="radio"/>	<input type="radio"/>		<input type="radio"/>	<input type="radio"/>	<input type="radio"/>	<input type="radio"/>	<input type="radio"/>	<input type="radio"/>	<input type="radio"/>	
Reset Tv/Av/  /ISO in Fv mode* ¹														
			<input type="radio"/>	<input type="radio"/>	<input type="radio"/>		<input type="radio"/>	<input type="radio"/>	<input type="radio"/>	<input type="radio"/>	<input type="radio"/>	<input type="radio"/>	<input type="radio"/>	
Quick Control screen														
			<input type="radio"/>	<input type="radio"/>	<input type="radio"/>		<input type="radio"/>	<input type="radio"/>	<input type="radio"/>	<input type="radio"/>	<input type="radio"/>	<input type="radio"/>	<input type="radio"/>	
Magnify/ Reduce														
			<input type="radio"/>	<input type="radio"/>	<input type="radio"/>		<input type="radio"/>	<input type="radio"/>	<input type="radio"/>	<input type="radio"/>	<input type="radio"/>	<input type="radio"/>	<input type="radio"/>	
Image replay														
			<input type="radio"/>	<input type="radio"/>	<input type="radio"/>		<input type="radio"/>	<input type="radio"/>	<input type="radio"/>	<input type="radio"/>	<input type="radio"/>	<input type="radio"/>	<input type="radio"/>	
Magnify images during playback														
					<input type="radio"/>		<input type="radio"/>	<input type="radio"/>	<input type="radio"/>		<input type="radio"/>			
Register/ recall shooting func* ¹														
MENU			<input type="radio"/>	<input type="radio"/>	<input type="radio"/>		<input type="radio"/>	<input type="radio"/>	<input type="radio"/>	<input type="radio"/>	<input type="radio"/>	<input type="radio"/>	<input type="radio"/>	
Menu display														

 Cropping/ aspect ratio														
 Switch between crop/aspect														
 Touch Shutter ¹														
 Create folder ¹														
 OVF sim. view assist ¹														
 Maximize screen brightness (temp)														
 Power off														
 Screen off														
 Unlock while button pressed														
 Switch between VF/screen														
 Network settings														
 Magnify/ Reduce button														
 Playback button														

INFO Info button		○	○	○		○	○	○	○		○	○		
 Erase button		○	○	○		○	○	○	○		○	○		
RATE Rating button		○	○	○		○	○	○	○		○	○		
OFF No function (disabled)		○	○	○	●	○	○	● ^{*3}	○	○	○	○	○	○

* 1: Cannot be assigned as a function available in movie recording.

* 3: Default in movie recording.





* 4: Default in still photo shooting.



Note

- **[L-Fn]**: "AF Stop" or "Lens Function" button on super telephoto lenses with Image Stabilizer.

Customize dials

Frequently used functions can be assigned to the <  >/<  >/<  >/<  > dials.

1. Select [: Customize dials].

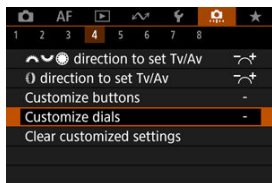

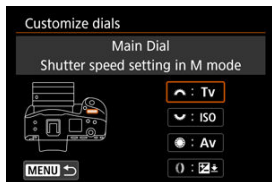

2. Select a camera control.

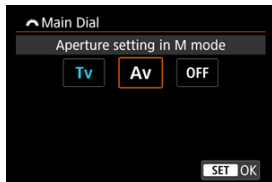

3. Select a function to assign.



- Press <  > to set it.
- You can configure advanced settings for functions labeled with [**INFO**] in the lower left of the screen by pressing the <  > button.



























Note

- [F10]: **Customize dials** settings are not cleared even if you select [F10]: **Clear all Custom Func. (C.Fn)**. To clear the settings, select [F10]: **Clear customized settings**.



Functions available for dials

●: Default ○: Available for customization

	Function				
AF 	Select AF area		○	○	○
	Direct AF point selection		○	○	
AF  	AF area (hold metering button)				○
Tv	Change shutter speed				○
Av	Change aperture value				○
	Exposure compensation		○	○	○
ISO	Set ISO speed		●	○	○
Tv 	Change shutter spd. (hold meter. btn)				○
Av 	Change aperture (hold meter. btn)				○
 	Exposure comp. (hold meter. btn)				●
ISO 	Set ISO speed (hold meter. btn)				○
 	Flash exp comp (hold meter. btn)				○
Tv	Shutter speed setting in M mode	●	○	○	
Av	Aperture setting in M mode	○	○	●	
WB	White balance selection		○	○	○
	Select color temperature		○	○	○
	Picture Style		○	○	○
WB 	Select WB (hold meter. btn)				○
 	Color temp. (hold meter. btn)				○
 	Select  (hold meter. btn)				○
OFF	No function (disabled)	○	○	○	○



Note

- The <  > dial cannot be customized in [Fv] mode.
- <  >: Control ring on RF lenses and mount adapters.

Clear customized settings

1. Select [: Clear customized settings].

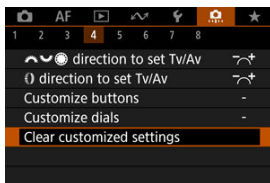

2. Select [OK].

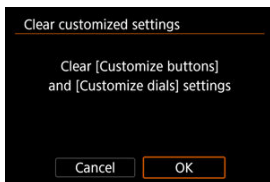

- [Customize buttons] and [Customize dials] are restored to defaults.

Switching (Movie/Photo)

You can change the functionality of the still photo shooting/movie recording switch. The movie recording screen is not displayed with this function set to **[Silent shutter function switching]** or **[Disable]**. Pressing the movie shooting button starts recording a movie as specified for Custom shooting mode [C3].

- : Still photo/movie recording
- : Silent shutter function switching
Setting the still photo shooting/movie recording switch to < > sets : Silent shutter function] to [On].
- : Disable

Smart controller

Enables you to move AF points by dragging on the smart controller after pressing the < > button.

- **ON: Enable**
Enables use of the smart controller in both vertical and horizontal shooting.
- : Disable vertical only
Disables use of the vertical-grip smart controller. Note that the vertical-grip smart controller is disabled even when assigned in **[Customize buttons]**.
- **OFF: Disable**
Disables use of the smart controller in both vertical and horizontal shooting, even when assigned in **[Customize buttons]**.

Caution

- This function is not available if you have set the **[AF-ON]** to **[Disable]** in **[C3: Customize buttons]**.

Note

- With **[Enable]** or **[Disable vertical only]** selected, you can press the < > button to adjust sensitivity, which changes the amount of AF point movement in response to dragging on the smart controller.

Vertical shooting controls

To prevent unintended operations, you can disable vertical shooting controls – buttons, dials, and the Multi-controller and smart controller near the bottom of the camera.

- **ON: On**
- **OFF: Off**
- **LOCK: Disable using lock**

Setting the multi-function lock switch to <LOCK> disables the controls. Note that the vertical-grip depth-of-field preview button and vertical-grip Multi-function button 2 can still be used.



Add cropping information

Adding cropping information displays vertical lines for the aspect ratio specified in shooting, so that you can compose shots as if shooting with a medium- or large-format camera (6×6 cm, 4×5 inch, and so on).

When you shoot, instead of cropping images recorded to the card, the camera adds aspect ratio information to images for cropping in the Digital Photo Professional (EOS software). You can import images to Digital Photo Professional on a computer and easily crop images to the aspect ratio set at the time of shooting.

- **OFF: Disable**
- **6:6: Aspect ratio 6:6**
- **3:4: Aspect ratio 3:4**
- **4:5: Aspect ratio 4:5**
- **6:7: Aspect ratio 6:7**
- **5:6: Aspect ratio 10:12**
- **5:7: Aspect ratio 5:7**

Caution

- Cropping information can only be added when [:  **Cropping/aspect ratio**] is set to **[Full-frame]**.
- JPEG or HEIF images are not saved at the cropped size if you use the camera to process RAW images with cropping information (). In this case, RAW processing produces JPEG or HEIF images with cropping information.

Note

- Vertical lines indicating your specified aspect ratio are displayed on the screen.

Shutter release time lag

Normally, the camera controls shooting so that the shutter-release time lag is consistent, but by setting [**Shortened**], you can disable this control to shorten the shutter-release time lag.

- | : **Standard**
- | : **Shortened**

Caution

- Shutter-release time lag varies by shooting conditions, type of lens, aperture value, and other factors.

Audio compression

Sets audio compression for movie recording. [**Disable**] allows higher audio quality than when audio is compressed, but file sizes are larger.

- **ON: Enable**
- **OFF: Disable**

Caution

- Editing movie files recorded with [**Disable**] and then saving them with compression will also compress the audio.
- Audio is compressed even if [**Disable**] is selected when [**Movie rec. size**] is set to **FHD 29.97P 1PB** (NTSC) or **FHD 25.00P 1PB** (PAL).

Default Erase option

You can set which option is selected by default in the erase menu (🗑️), which is accessed by pressing the < 🗑️ > button during image playback or during review after shooting.

By setting an option other than [Cancel], you can simply press < (SET) > to erase images quickly.

- 🗑️: [Cancel] selected
- 🗑️: [Erase] selected
- RAW: [Erase RAW] selected
- J/H: [Erase non-RAW] selected
- 🗑️: [Erase voice memo] selected

⚠️ Caution

- Be careful not to erase images accidentally when an option other than [Cancel] is set.

Av setting without lens

You can specify whether the aperture value can still be set without a lens attached.

- OFF: Disable
- ON: Enable

Aperture value can still be set without a lens attached. Convenient when you want to prepare for shooting and have already decided about the aperture value.

Release shutter w/o lens

You can specify whether shooting still photos or movies is possible without a lens attached.

- OFF: Disable
- ON: Enable

Retract lens on power off

You can set whether to retract gear-type STM lenses (such as RF35mm F1.8 Macro IS STM) automatically when the camera's power switch is set to < **OFF** >.

- **ON: Enable**
- **OFF: Disable**

Caution

- With auto power off, the lens will not retract regardless of the setting.
- Before detaching the lens, make sure that it is retracted.

Note

- When [**Enable**] is set, this function takes effect regardless of the lens's focus mode switch setting (AF or MF).

Add IPTC information

Registering IPTC (International Press Telecommunications Council) information to the camera from EOS Utility (EOS software) enables you to record (add) this information to JPEG/HEIF/RAW still photos at the time of shooting. **This is helpful in file management and other tasks using the IPTC information.**

For instructions on registering IPTC information to the camera and details on the information you can register, refer to the EOS Utility Instruction Manual.

- **OFF: Disable**
- **ON: Enable**

Caution

- IPTC information is not added when you record movies.



Note

- During playback, you can check whether IPTC information was added.
- You can use Digital Photo Professional (EOS software) to check IPTC information in images.
- IPTC information registered to the camera is not erased if you select [MENU]: **Clear all Custom Func. (C.Fn)** (C.Fn), but the setting changes to **[Disable]**.

Clear all Custom Func. (C.Fn)

Selecting [.8]: **Clear all Custom Func. (C.Fn)** clears all Custom Function settings except the following functions.

- **Customize buttons**
- **Customize dials**
- **switching (P/ /)**
- **Smart controller**



Note

- To clear settings configured with [.8]: **Customize buttons** and [.8]: **Customize dials**, select [.8]: **Clear customized settings**.
- Settings for [.8]: **AE Microadjustment** and [.8]: **FE Microadjustment** are set to **[Disable]** but not cleared when [.8]: **Clear all Custom Func. (C.Fn)** is performed. Note that although information added using [.8]: **Add IPTC information** is retained, the setting changes to **[Disable]**.

Tab Menus: My Menu

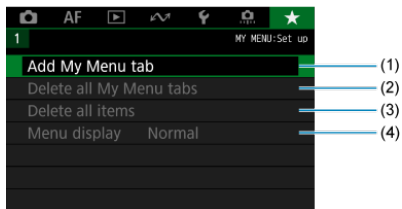

- (1) [Add My Menu tab](#)
- (2) [Delete all My Menu tabs](#)
- (3) [Delete all items](#)
- (4) [Menu display](#)

Registering My Menu

- [Creating and Adding My Menu Tabs](#)
- [Registering Menu Items on My Menu Tabs](#)
- [My Menu Tab Settings](#)
- [Deleting All My Menu Tabs/Deleting All Items](#)
- [Menu Display Settings](#)

On the My Menu tab, you can register menu items and Custom Functions you often adjust.

Creating and Adding My Menu Tabs

1. Select [Add My Menu tab].

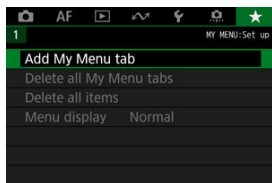

2. Select [OK].

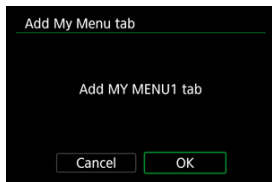

- You can create up to five My Menu tabs by repeating steps 1 and 2.

1. Select [MY MENU*: Configure].

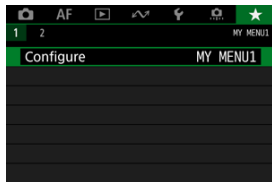

2. Select [Select items to register].

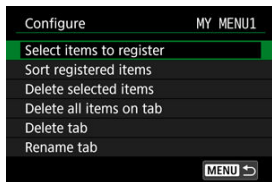

3. Register the desired items.

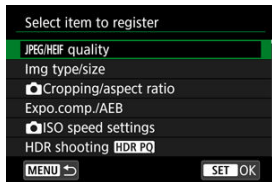

- Select an item, then press < (SET) >.
- Select [OK] on the confirmation screen.
- You can register up to six items.
- To return to the screen in step 2, press the < MENU > button.

My Menu Tab Settings

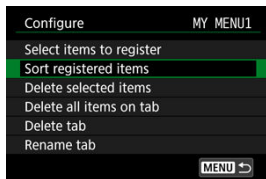

You can sort and delete items on the menu tab, and rename or delete the menu tab itself.

- **Sort registered items**

You can change the order of the registered items in My Menu. Select [**Sort registered items**], select an item to rearrange, then press < (SET) >. With [↕] displayed, turn the < (◂) > dial to rearrange the item, then press < (SET) >.

- **Delete selected items/Delete all items on tab**

You can delete any of the registered items. [**Delete selected items**] deletes one item at a time, and [**Delete all items on tab**] deletes all the registered items on the tab.

- **Delete tab**

You can delete the current My Menu tab. Select [**Delete tab**] to delete the [**MY MENU***] tab.





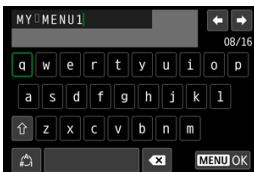

- **Rename tab**

You can rename the My Menu tab from [MY MENU*].

1. **Select [Rename tab].**

2. **Enter text.**



- Use the <  > or <  > dial or <  > to select a character, then press <  > to enter it.
- By selecting [], you can change the input mode.
- To delete single characters, select [] or press the <  > button.

3. **Confirm input.**

- Press the < **MENU** > button, then select [**OK**].

Deleting All My Menu Tabs/Deleting All Items

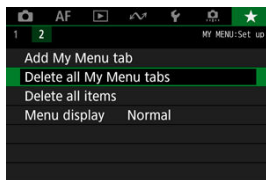

You can delete all the created My Menu tabs or My Menu items registered on them.

- **Delete all My Menu tabs**

You can delete all My Menu tabs you created. When you select [**Delete all My Menu tabs**], all the tabs from [**MY MENU1**] to [**MY MENU5**] will be deleted and the [**★**] tab will revert to its default.

- **Delete all items**

You can delete all the items registered under the [**MY MENU1**] to [**MY MENU5**] tabs. The tabs themselves will remain. When [**Delete all items**] is selected, all the items registered on all the created tabs will be deleted.

! **Caution**

- Performing [**Delete tab**] or [**Delete all My Menu tabs**] will also delete tab names renamed with [**Rename tab**].

Menu Display Settings

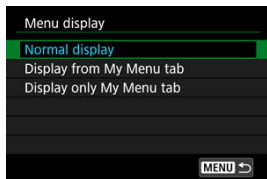

You can select [**Menu display**] to set the menu screen that is to appear first when you press the <MENU> button.

- **Normal display**

Displays the last displayed menu screen.

- **Display from My Menu tab**

Displays with the [★] tab selected.

- **Display only My Menu tab**

Restricts display to the [★] tab ([📷]/[AF]/[▶]/[📺]/[🔍]/[🔧] tabs are not displayed).

Reference

This chapter provides reference information on camera features.

- [Importing Images to a Computer](#)
- [Importing Images to a Smartphone](#)
- [Using an Optional USB Power Adapter to Charge the Camera](#)
- [Troubleshooting Guide](#)
- [Error Codes](#)
- [ISO Speed in Movie Recording](#)
- [Information Display](#)
- [Specifications](#)

Importing Images to a Computer

[Connecting to a Computer with an Interface Cable](#)

[Using a Card Reader](#)

[Connecting to a Computer via Wi-Fi](#)

You can use EOS software to import images from the camera to a computer. There are three ways to do this.

If you will import many images, consider using a household power outlet accessory (sold separately).

Connecting to a Computer with an Interface Cable

1. Install EOS Utility .
2. Connect the camera to the computer.

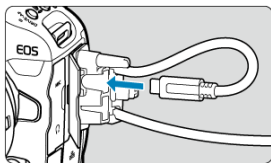

- Use the interface cable included with the camera.
 - When connecting the cable to the camera, use the cable protector and insert the plug in the digital terminal.
 - Insert the other end of the cable into the computer's USB terminal (Type-C).
3. Use EOS Utility to import the images.
 - Refer to the EOS Utility Instruction Manual.

Using a Card Reader

You can use a card reader to import images to a computer.

1. **Install Digital Photo Professional** .
2. **Insert the card into the card reader.**
3. **Use Digital Photo Professional to import the images.**

- Refer to the Digital Photo Professional Instruction Manual.



Note

- When downloading images from the camera to a computer with a card reader without using EOS software, copy the DCIM folder on the card to the computer.

Connecting to a Computer via Wi-Fi

You can connect the camera to the computer via Wi-Fi and import images to the computer (🔗).



Note

- By connecting to an FTP server, you can send images on the camera to a computer (🔗).

Importing Images to a Smartphone

You can import images from the camera to a smartphone by connecting the smartphone to the camera with Multi-Function Shoe Adapter for Smartphone Link AD-P1 (sold separately, for Android smartphones only) or a USB cable.

Preparation

1. Select an option in [**☛: Choose USB connection app**] (📷).
 - Select [**Photo Import/Remote Control**] when connecting an Android smartphone, or when connecting an iPhone and using the Photos app.
 - After the settings are complete, turn the camera off.

2. Connect the camera to the smartphone with AD-P1 or a USB cable.
 - When using AD-P1, refer to the instruction manual included with AD-P1.
 - Use of a Canon USB cable (Interface Cable IFC-100U or IFC-400U) is recommended when connecting Android smartphones.
 - For details on USB cables used to connect iPhones, visit the Canon website.

Using smartphone features

1. Turn the camera on.

2. Use the smartphone to import images.
 - Android smartphones: In the [**Files**] menu, select [**Canon Digital Camera *****], then import images in the DCIM folder.
 - iPhones: Start the Photos app, then import images from the card.

Using an Optional USB Power Adapter to Charge the Camera

Using USB Power Adapter PD-E1 (sold separately), you can charge Battery Pack LP-E19 without removing it from the camera.

1. Connect the USB power adapter.

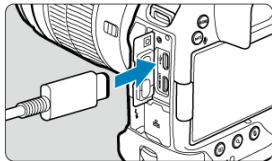

- With the camera power switch set to <OFF>, insert the USB power adapter plug fully into the <  > terminal.

2. Connect the power cord.

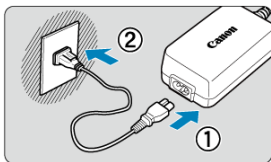

- Connect the power cord to the USB power adapter and plug the other end into a power outlet.
- Charging begins, and the access lamp (1) is lit in green.
- [⚡] is displayed on the LCD panel.

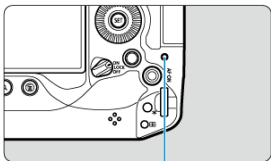

(1)

- When charging is finished, the access lamp turns off.

⚠ Caution

- To protect the battery pack and keep it in optimal condition, do not charge it continuously for more than 24 hours.
- Charged batteries gradually lose their charge, even when they are not used.
- If the charging lamp fails to light up or a problem occurs during charging (shown by the access lamp blinking in green), unplug the power cord, reinsert the battery, and wait a few minutes before plugging it in again. If the problem persists, take the camera to the nearest Canon Service Center.
- The charging time required and the amount charged vary depending on ambient temperature and remaining capacity.
- For safety, charging in low temperatures takes longer.
- The camera cannot be powered with USB Power Adapter PD-E1.
- Some commercially available power adapters have been confirmed to charge and power the camera. For details, check the Canon website ([🔗](#)).

Troubleshooting Guide

- [✔ Power-related problems](#)
- [✔ Shooting-related problems](#)
- [✔ Problems with wireless features](#)
- [✔ Operation problems](#)
- [✔ Display problems](#)
- [✔ Playback problems](#)
- [✔ Sensor cleaning problems](#)
- [✔ Computer connection problems](#)
- [✔ Problems with the multi-function shoe](#)

If a problem occurs with the camera, first refer to this Troubleshooting Guide. If this Troubleshooting Guide does not resolve the problem, take the camera to the nearest Canon Service Center.

Power-related problems

Batteries cannot be charged with the battery charger.

- The included Battery Charger LC-E19 is designed exclusively for Battery Pack LP-E19.
- In case of charging or charger issues, see [Charging the Battery](#).

The charger's lamp blinks at high speed.

- If (1) the battery charger or battery has a problem or (2) communication with the battery failed (with a non-Canon battery pack), the protection circuit will stop charging, and the charge lamp will blink in orange at a constant high speed. In the case of (1), unplug the charger's power plug from the power outlet, reattach the battery, wait a few minutes, and then reconnect the power plug to the power outlet. If the problem persists, take the camera to the nearest Canon Service Center.

The charger's lamp does not blink.

- If the internal temperature of the battery attached to the charger is high, the charger will not charge the battery for safety reasons (lamp off). During charging, if the battery's temperature becomes high for any reason, charging will stop automatically (lamp blinks). When the battery temperature goes down, charging will resume automatically.

Batteries cannot be charged with the USB power adapter (sold separately).

- Batteries are not charged while the camera power switch is set to < ON >. However, batteries are charged during auto power off.
- Operating the camera will stop charging in progress.

The access lamp blinks during charging with the USB power adapter.

- In case of charging problems, the access lamp blinks in green and a protective circuit stops charging. In this case, unplug the power cord, reattach the battery, and wait a few minutes before plugging it in again. If the problem persists, take the camera to the nearest Canon Service Center.

The access lamp is not lit during charging with the USB power adapter.

- Try unplugging the USB power adapter and plugging it in again.

The camera is not activated even when the power switch is set to < ON >.

- Make sure the battery is inserted properly in the camera (🔗).
- Make sure the card slot cover is closed (🔗).
- Charge the battery (🔗).

The access lamp still lights or blinks even when the power switch is set to < OFF >.

- If the power is turned off while an image is being recorded to the card, the access lamp will remain on or continue to blink for a few seconds. When the image recording is complete, the power will turn off automatically.

[Does this battery/ do these batteries display the Canon logo?] is displayed.

- Do not use any battery packs other than a genuine Canon Battery Pack LP-E19.
- Remove and install the battery again (🔗).
- If the electrical contacts are dirty, use a soft cloth to clean them.

The battery becomes exhausted quickly.

- Use a fully charged battery (🔗).
- The battery performance may have degraded. See [🔗: **Battery info.**] to check the battery recharge performance level (🔗). If the battery performance is poor, replace the battery with a new one.
- The number of available shots will decrease with any of the following operations:
 - Pressing the shutter button halfway for a prolonged period
 - Activating the AF frequently without taking a picture
 - Using GPS
 - Using the lens's Image Stabilizer
 - Using the wireless communication functions
 - Using accessories compatible with the multi-function shoe

The camera turns off by itself.

- Auto power off is in effect. To deactivate auto power off, set [**Auto power off**] in [🔗: **Power saving**] to [**Disable**] (🔗).
- Even if [**Auto power off**] is set to [**Disable**], the screen and viewfinder will still turn off after the camera is left idle for the time set in [**Screen off**] or [**Viewfinder off**] (although the camera itself remains on).

Shooting-related problems

The lens cannot be attached.

- To attach EF or EF-S lenses, you will need a mount adapter. The camera cannot be used with EF-M lenses (🔗).

No images can be shot or recorded.

- Make sure the card is properly inserted (🔗).
- Slide the card's write-protect switch to the Write/Erase setting (🔗).
- If the card is full, replace the card or delete unnecessary images to make space (🔗, 🔗).
- Shooting is not possible if the AF point turns orange when you attempt to focus. Press the shutter button halfway again to refocus automatically, or focus manually (🔗, 🔗).

The card cannot be used.

- If a card error message is displayed, see [Inserting/Removing Cards](#) and [Error Codes](#).

An error message is displayed when the card is inserted in another camera.

- Since SDXC cards are formatted in exFAT, if you format a card with this camera and then insert it into another camera, an error may be displayed and it may not be possible to use the card.

The image is out of focus or blurred.

- Set the lens's focus mode switch to < AF > (🔗). For lenses without a focus mode switch, set [AF: Focus mode] to [AF].
- Press the shutter button gently to prevent camera shake (🔗).
- With a lens equipped with an Image Stabilizer, set the Image Stabilizer switch to < ON >.
- In low light, the shutter speed may become slow. Use a faster shutter speed (🔗), set a higher ISO speed (🔗), use flash (🔗), or use a tripod.

I cannot lock the focus and recompose the shot.

- Set the AF operation to One-Shot AF (🔗). Shooting with the focus locked is not possible with Servo AF (🔗).

The continuous shooting speed is slow.

- High-speed continuous shooting may be slower depending on the battery level, ambient temperature, flickering light, shutter speed, aperture value, subject conditions, brightness, AF operation, type of lens, use of flash, shooting settings, and other conditions. For details, see [Selecting the Drive Mode](#) or [Still photo file size / Number of possible shots / Maximum burst for continuous shooting](#).

The maximum burst during continuous shooting is lower.

- Shooting intricate subjects such as fields of grass may result in larger file sizes, and the actual maximum burst may be lower than the guidelines in [Still photo file size / Number of possible shots / Maximum burst for continuous shooting](#).

Even after I change the card, the maximum burst displayed for continuous shooting does not change.

- Estimated maximum burst indicated in the viewfinder does not change when you switch cards, even if you switch to a high-speed card. Maximum burst listed in [Still photo file size / Number of possible shots / Maximum burst for continuous shooting](#) is based on the standard Canon test card, and the actual maximum burst is higher for cards with faster writing speeds. For this reason, estimated maximum burst may differ from actual maximum burst.

High-speed display is not available during high-speed continuous shooting.

- Refer to the high-speed display requirements in [High-Speed Display](#).

Some image quality options are not available with cropped shooting.

- **M/S1** image quality options are not available when **[1.6x (crop)]** is set, or with RF-S or EF-S lenses.

The aspect ratio cannot be set.

- Aspect ratios cannot be set for RF-S or EF-S lenses (**[1.6x (crop)]** is set automatically).
- Aspect ratios cannot be set when **[.📷: Add cropping information]** is set to an option other than **[Disable]**.

ISO 100 cannot be set for still photo shooting.

- The minimum speed in the ISO speed range is ISO 200 when **[📷: Highlight tone priority]** is set to **[Enable]** or **[Enhanced]**.

Expanded ISO speeds cannot be selected for still photo shooting.

- Expanded ISO speeds are not available when [📷: Highlight tone priority] is set to [Enable] or [Enhanced].
- Expanded ISO speeds are not available when [📷: HDR shooting [HDR PQ]] is set to [Enable].
- Check the [ISO speed range] setting under [📷: ISO speed settings].

Even if I set a decreased exposure compensation, the image comes out bright.

- Set [📷: Auto Lighting Optimizer] to [Disable] (🔒). When [Low], [Standard], or [High] is set, even if you set a decreased exposure compensation or flash exposure compensation, the image may come out bright.

I cannot set the exposure compensation when both manual exposure and ISO Auto are set.

- See [M: Manual Exposure](#) to set the exposure compensation.

Not all the lens aberration correction options are displayed.

- With [Digital Lens Optimizer] set to [Standard] or [High], [Chromatic aberr corr] and [Diffraction correction] are not displayed, but they are both set to [Enable] for shooting.
- [Digital Lens Optimizer] is not displayed in movie recording.

Images are not displayed after shooting in multiple-exposure shooting.

- When [On:ContShtng] is set, images are not displayed for review after capture, and image playback is not available (🔒).

Using flash in [AV] or [P] mode lowers the shutter speed.

- Set [Slow synchro] in [📷: External Speedlite control] to [1/200-1/60sec. auto] (or [1/250-1/60sec. auto]) or [1/200 sec. (fixed)] (or [1/250 sec. (fixed)]) (🔒).

The flash does not fire.

- Make sure any flash units are securely attached to the camera.

The flash always fires at full output.

- Flash units other than EL/EX series Speedlites used in autoflash mode always fire at full output (🔗).
- When the flash Custom Function setting for **[Flash metering mode]** is set to **[TTL flash metering]** (autoflash), the flash will always fire at full output (🔗).

Flash exposure compensation cannot be set.

- If flash exposure compensation is already set with the Speedlite, flash exposure compensation cannot be set with the camera. When the Speedlite's flash exposure compensation is canceled (set to 0), flash exposure compensation can be set with the camera.

High-speed sync is not available in [AV] or [FV] mode.

- Set **[Slow synchro]** in **[📷: External Speedlite control]** to an option other than **[1/200 sec. (fixed)]** (or **[1/250 sec. (fixed)]**) (🔗).

Remote control shooting is not possible.

- In still photo shooting, set the drive mode to **[iS]** or **[iS2]** (🔗). In movie recording, set **[📷: Remote control]** to **[Enable]** (🔗).
- Check the position of the remote control's release timing switch.
- If you are using Wireless Remote Control BR-E1, see [Remote Control Shooting](#) or [Connecting to a Wireless Remote Control](#).
- To use a remote control for time-lapse movie recording, see [Time-Lapse Movies](#).

A white [🔥] or red [🔥] icon is displayed during shooting.

- Indicates that the camera's internal temperature is high. Image quality of still photos may be worse when a white [🔥] icon is displayed. Display of a red [🔥] icon indicates that shooting will soon stop automatically (🔗).

[🔥] or a red [🔥] icon is displayed during movie recording.

- Indicates that the camera's internal temperature is high. A red [🔥] icon will be displayed if you continue recording while [🔥] is displayed. If this condition continues, movie recording will automatically stop, and you will be unable to record movies or shoot still photos until the camera has cooled down.

Movie recording stops by itself.

- If the card's writing speed is slow, movie recording may stop automatically. For details on cards that can record movies, see [Card performance requirements](#). To find out the card's writing speed, refer to the card manufacturer's website, etc.
- Perform low-level formatting to initialize the card if the card's writing or reading speed seems slow (🔗).
- Movie recording stops automatically if you record a high frame rate movie for 89 min. 29 sec.

The ISO speed cannot be set for movie recording.

- ISO speed is set automatically in [📷] recording mode. In [📷M] mode, you can manually set the ISO speed (🔗).
- The minimum speed in the ISO speed range is ISO 200 when [📷: Highlight tone priority] is set to [Enable] or [Enhanced].

Expanded ISO speeds cannot be selected for movie recording.

- Check the [ISO speed range] setting under [📷: 📷ISO speed settings].
- Expanded ISO speeds are not available when [📷: Highlight tone priority] is set to [Enable] or [Enhanced].

The exposure changes during movie recording.

- If you change the shutter speed or aperture value during movie recording, the changes in the exposure may be recorded.
- Recording a few test movies is recommended if you intend to perform zooming during movie recording. Zooming as you record movies may cause exposure changes or lens sounds to be recorded, or loss of focus.

The image flickers or horizontal stripes appear during movie recording.

- Flickering, horizontal stripes (noise), or irregular exposures can be caused by fluorescent lighting, LED lighting, or other light sources during movie recording. Also, changes in the exposure (brightness) or color tone may be recorded. In [📷M] mode, using a slower shutter speed may reduce the problem. The problem may be more noticeable in time-lapse movie recording.

The subject looks distorted during movie recording.

- If you move the camera to the left or right (panning) or shoot a moving subject, the image may look distorted. The problem may be more noticeable in time-lapse movie recording.

Sound is not recorded in movies.

- Sound is not recorded in High Frame Rate movies.

A time code is not added.

- Time codes are not added when you record High Frame Rate movies with [Count up] in [📷: Time code] set to [Free run] (🔗). Additionally, no time code is added to HDMI video output (🔗).

Time codes advance faster than the actual time.

- Count-up of time codes during High Frame Rate movie recording is based on 29.97/25.00 fps (🔗).

I cannot take still photos during movie recording.

- Still photos cannot be taken during movie recording. To shoot still photos, stop recording the movie, then select a shooting mode for still photos.

I cannot record movies during still photo shooting.

- It may not be possible to record movies during still photo shooting if operations such as extended image display increase the camera's internal temperature. Turn off the camera or take other measures, and wait until the camera cools down.
- Lowering the [📷] movie recording quality may enable movie recording.

Cannot record movies.

- Format (initialize) the card with this camera (🔗).
- Use an SDXC card as card [2].

The camera vibrates.

- Image stabilization by the camera may make the camera seem to vibrate. This does not indicate damage.

Cannot pair with a smartphone.

- Use a smartphone compliant with Bluetooth Specification Version 4.1 or later.
- Turn on Bluetooth from the smartphone settings screen.
- Pairing with the camera is not possible from the smartphone's Bluetooth settings screen. Install the dedicated app Camera Connect (free of charge) on the smartphone (📲).
- Pairing with a previously paired smartphone is not possible if pairing information registered for another camera remains on the smartphone. In this case, remove the camera's registration retained in the Bluetooth settings on the smartphone and try pairing again (📲).

Operations such as shooting and playback are not possible.

- With a Wi-Fi connection established, operations such as shooting and playback may not be possible. Terminate the Wi-Fi connection, then perform the operation.

Cannot reconnect to a smartphone.



- Even with a combination of the same camera and smartphone, if you have changed the settings or selected a different setting, reconnection may not be established even after selecting the same SSID. In this case, delete the camera connection settings from the Wi-Fi settings on the smartphone and set up a connection again.
- A connection may not be established if Camera Connect is running when you reconfigure connection settings. In this case, quit Camera Connect for a moment and then restart it.

Operation problems

Settings change when I switch from still photo shooting to movie recording or vice versa.

- Separate settings are retained for use when shooting still photos and recording movies.



Settings cannot be changed with , , , , , , or .

- Set the power/multi-function lock switch to **< ON >** and release the multi-function lock .
- Check the [: **Multi function lock**] setting .



Settings cannot be changed with .

- Set [:  **Smart controller**] to [Enable] or [Disable vertical  only].





Settings cannot be changed with , , or for vertical shooting.

- Set [:  **Smart controller**] to [Enable].
- Set [: **Vertical shooting controls**] to [On] or [Disable using lock].

Touch operation is not possible.

- Make sure [: **Touch control**] is set to [Standard] or [Sensitive] .

A camera button or dial does not work as expected.

- In movie recording, check the [: **Shutter btn function for movies**] setting .
- Check the [: **Customize buttons**] and [: **Customize dials**] settings .

Display problems

The menu screen shows fewer tabs and items.

- Tabs and items on the menu screen vary for still photos and movies.

The display starts with [★] My Menu, or the [★] tab alone is displayed.

- [Menu display] on the [★] tab is set to [Display from My Menu tab] or [Display only My Menu tab]. Set [Normal display] (🔗).

The file name's first character is an underscore (“_”).

- Set [📷: Color space] to [sRGB]. If [Adobe RGB] is set, the first character will be an underscore (🔗).

The fourth character in the file name changes.

- [📁: File name] is set to [*** + image size]. Select either the camera's unique file name or the file name registered in User setting 1 (🔗).

The file numbering does not start from 0001.

- If the card already contains recorded images, the image number may not start from 0001 (🔗).

The shooting date and time displayed are incorrect.

- Make sure the correct date and time are set (🔗).
- Check the time zone and daylight saving time (🔗).

The date and time are not in the image.

- The shooting date and time do not appear in the image. The date and time are recorded in the image data as shooting information. When you print photos, this information can be used to include the date and time (🔗).

[###] is displayed.

- If the number of images recorded on the card exceeds the number the camera can display, [###] will be displayed.

The screen does not display a clear image.

- If the screen is dirty, use a soft cloth to clean it.
- The screen display may seem slightly slow in low temperatures or may look black in high temperatures, but it will return to normal at room temperature.

Part of the image blinks in black.

- [▶]: **Highlight alert** is set to **[Enable]** (🔗).

A red box is displayed on the image.

- [▶]: **AF point disp.** is set to **[Enable]** (🔗).

During image playback, the AF points are not displayed.

- AF points are not displayed when the following types of images are played back:
 - Images taken with Multi Shot Noise Reduction applied.
 - Cropped images.
 - Images from HDR shooting with **[Auto Image Align]** set to **[Enable]**.

The image cannot be erased.

- If the image is protected, it cannot be erased (🔗).

Still photos and movies cannot be played back.

- The camera may not be able to play back images taken with another camera.
- Movies edited with a computer cannot be played back with the camera.

Only few images can be played back.

- The images have been filtered for playback with [▶]: **Set image search conditions** (🔗). Clear the image search conditions.

Mechanical sounds or sounds of camera operations can be heard during movie playback.

- The camera's built-in microphone may also record mechanical sounds of the lens or sounds of camera/lens operations if AF operations are performed or the camera or lens is operated during movie recording. If so, it may help reduce these sounds if you use an external microphone equipped with an output plug and position it away from the camera and lens.

Movie playback stops by itself.

- Extended movie playback or movie playback under high ambient temperature may cause the camera's internal temperature to rise, and movie playback may stop automatically.
If this happens, playback is disabled until the camera's internal temperature decreases, so turn off the power and let the camera cool down a while.

The movie appears to freeze momentarily.

- Significant change in the exposure level during autoexposure movie recording may cause recording to stop momentarily until the brightness stabilizes. In this case, record in [iA/M] mode (🔗).

The movie is played in slow motion.

- Because High Frame Rate movies are recorded as 29.97/25.00 fps movies, they are played back in slow motion.

No picture appears on the television.

- Make sure [🔧: Video system] is set to [For NTSC] or [For PAL] correctly for the video system of your television.
- Make sure the HDMI cable's plug is inserted all the way in (🔗).

There are multiple movie files for a single movie recording.

- If the movie file size reaches 4 GB, another movie file will be created automatically (🔗). However, if you use an SDXC card formatted with the camera, you can record a movie in a single file even if it exceeds 4 GB.

My card reader does not recognize the card.

- Depending on the card reader used and the computer's operating system, SDXC cards may not be correctly recognized. In this case, connect the camera to the computer with the interface cable, then import the images to the computer using EOS Utility (EOS software, 🔗).

Images cannot be resized or cropped.



- This camera cannot resize JPEG S2 images, RAW images, or frame-grab images from 4K movies saved as still photos (🔗).
- This camera cannot crop RAW images or frame-grab images from 4K movies saved as still photos (🔗).

Dots of light appear on the image.

- White, red, or blue dots of light may appear in captured images if the sensor is affected by cosmic rays or similar factors. Their appearance may be reduced by performing [Clean now, 🗑️] under [🔧: Sensor cleaning] (🔗).

Sensor cleaning problems

The shutter makes a sound during sensor cleaning.

- Although there is a mechanical sound from the shutter during cleaning after [**Clean now** ] is selected, no image is recorded to the card ().

Automatic sensor cleaning does not work.

- Repeatedly turning the power switch < **ON** > and < **OFF** > within a short period may prevent the [] icon from being displayed ().

Computer connection problems

I cannot import images to a computer.

- Install EOS Utility (EOS software) on the computer (🔗).
- Make sure the main EOS Utility window is displayed.
- Check the version of the application.

Communication between the connected camera and computer does not work.

- When using EOS Utility (EOS software), set [📷: Time-lapse movie] to [Disable] (🔗).

Problems with the multi-function shoe

A message was displayed on the screen when I attached an accessory.

- If [Communication error Reattach accessory] is displayed, reattach the accessory. In case this message is displayed again after reattachment, make sure the terminals of the multi-function shoe and accessory are clean and dry. If you cannot remove the dirt or moisture, contact a Canon Service Center.
- If [Accessory unavailable status] is displayed, check the terminals of the multi-function shoe and accessory and make sure the accessory is not damaged.

I cannot use USB on the camera while using Multi-Function Shoe Adapter for Smartphone Link AD-P1.

- The camera USB port is not available while Multi-Function Shoe Adapter for Smartphone Link AD-P1 is in use. To use the camera USB port, disconnect AD-P1.

Error Codes

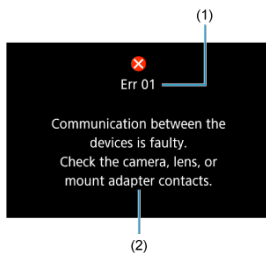

(1) Error number

(2) Cause and countermeasures

If there is a problem with the camera, an error message will appear. Follow the on-screen instructions.

If the problem persists, write down the error code (Err xx) and request service.

ISO Speed in Movie Recording

In [P], [Tv], and [Av] mode

- ISO speed is set automatically in a range of ISO 100–25600.
- Setting **[Max for Auto]** in [CAMERA]: **ISO speed settings** to **[H(102400)]** (🔗) expands the maximum speed in the automatic setting range to H (equivalent to ISO 102400).
- The minimum speed in the automatic setting range is ISO 200 when [CAMERA]: **Highlight tone priority** is set to **[Enable]** or **[Enhanced]** (🔗). The maximum limit is not expanded, even when expansion is set in **[Max for Auto]**.
- The minimum speed in the automatic setting range is ISO 800 when [CAMERA]: **Canon Log settings** is set to **[On (CLOG3)]** (🔗). ISO 100–400 represents an expanded ISO speed (L).

In [M] mode

- With ISO speed set to **[AUTO]**, ISO speed is set automatically in a range of ISO 100–25600.
- Setting **[Max for Auto]** in [CAMERA]: **ISO speed settings** to **[H(102400)]** (🔗) expands the maximum speed in the automatic setting range to H (equivalent to ISO 102400).
- ISO speed can be set manually in a range of ISO 100–25600. Setting **[ISO speed range]** in [CAMERA]: **ISO speed settings** to **[H(102400)]** (🔗) expands the maximum speed in the manual setting range to H (equivalent to ISO 102400).
- The minimum speed in the automatic or manual setting range is ISO 200 when [CAMERA]: **Highlight tone priority** is set to **[Enable]** or **[Enhanced]** (🔗). Even when ISO speed expansion is set, the maximum limit will not be expanded.
- The minimum speed in the automatic setting range is ISO 800 when [CAMERA]: **Canon Log settings** is set to **[On (CLOG3)]** (🔗). ISO 100–400 represents an expanded ISO speed (L).

Information Display

- [LCD Panel](#)
- [Still Photo Shooting Screen](#)
- [Movie Recording Screen](#)
- [Playback Screen](#)

LCD Panel

Still photo/movie standby screen 1

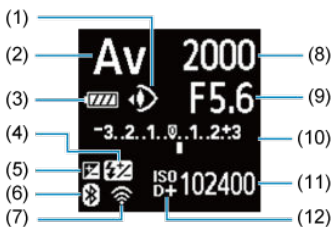

- | | |
|------|---|
| (1) | Eye control |
| (2) | Shooting mode |
| (3) | Battery level |
| (4) | Flash exposure compensation |
| (5) | Exposure compensation |
| (6) | Bluetooth function |
| (7) | Wi-Fi /wired LAN |
| (8) | Shutter speed |
| (9) | Aperture value |
| (10) | Exposure level indicator/Exposure compensation amount/AEB range |
| (11) | ISO speed |
| (12) | Highlight tone priority |

Still photo/movie standby screen 2

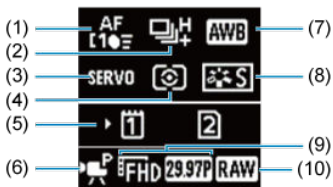

-
- (1) AF area
 - (2) Drive mode
 - (3) AF operation
 - (4) Metering mode
 - (5) Card slot
 - (6) Movie recording mode
 - (7) White balance
 - (8) Picture Style
 - (9) Movie recording size
 - (10) Movie recording format
-

Movie standby screen 3

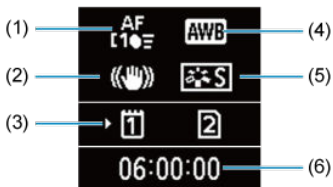

-
- | | |
|-----|--------------------------------|
| (1) | AF area |
| (2) | Image Stabilizer (IS mode) |
| (3) | Card slot |
| (4) | White balance |
| (5) | Picture Style/Canon Log |
| (6) | Movie recording time available |
-

Movie recording in progress

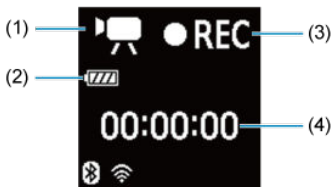

-
- | | |
|-----|---|
| (1) | Movie recording mode |
| (2) | Battery level |
| (3) | Recording in progress/External recording in progress (10-bit, via HDMI) |
| (4) | Elapsed recording time |
-

Still Photo Shooting Screen

Each time you press the <INFO> button, the information display will change.

- The display will show only the settings currently applied.

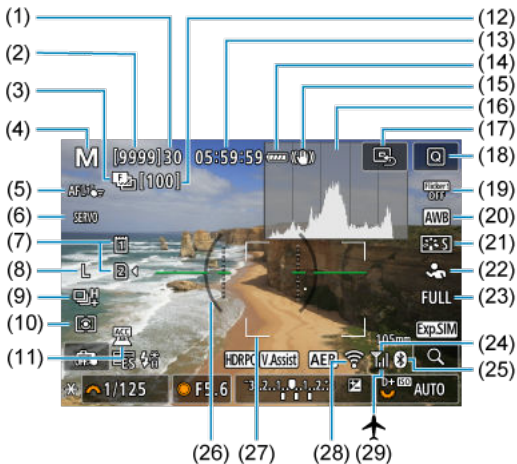

(1)	Maximum burst
(2)	Number of available shots/Sec. until self-timer shoots
(3)	Focus bracketing/HDR/Multiple exposures/Multi Shot Noise Reduction/Bulb timer/Interval timer
(4)	Shooting mode
(5)	AF area
(6)	AF operation
(7)	Card
(8)	Image quality
(9)	Drive mode
(10)	Metering mode
(11)	Accessory compatible with the multi-function shoe attached
(12)	No. of remaining shots for focus bracketing, multiple exposures, or interval timer
(13)	Movie recording time available
(14)	Battery level
(15)	Image Stabilizer (IS mode)
(16)	Histogram (Brightness/RGB)
(17)	Set AF point to center
(18)	Quick Control button
(19)	Anti-flicker shooting
(20)	White balance/White balance correction
(21)	Picture Style
(22)	Subject to detect
(23)	Still photo cropping/Aspect ratio
(24)	Wi-Fi signal strength
(25)	Bluetooth function
(26)	Electronic level
(27)	AF point (Flexible Zone AF 1)
(28)	Wi-Fi function
(29)	Airplane mode

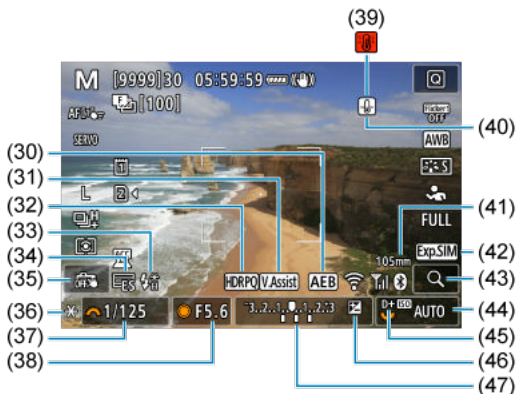

-
- (30) AEB/FEB
-
- (31) View Assist
-
- (32) HDR PQ
-
- (33) Flash ready/FE lock/High-speed sync
-
- (34) Electronic shutter
-
- (35) Touch Shutter/Create folder
-
- (36) AE lock
-
- (37) Shutter speed/Multi-function lock warning
-
- (38) Aperture value
-
- (39) Overheating warning
-
- (40) Still photo image quality warning
-
- (41) Focal length
-
- (42) Display simulation
-
- (43) Magnify button
-
- (44) ISO speed
-
- (45) Highlight tone priority
-
- (46) Exposure compensation
-
- (47) Exposure level indicator
-



Note

- You can specify the information displayed in response to pressing the < INFO > button ().
- The electronic level is not displayed when the camera is connected via HDMI to a television.
- Other icons may be displayed temporarily after setting adjustments.

Movie Recording Screen

Each time you press the <INFO> button, the information display will change.

- The display will show only the settings currently applied.

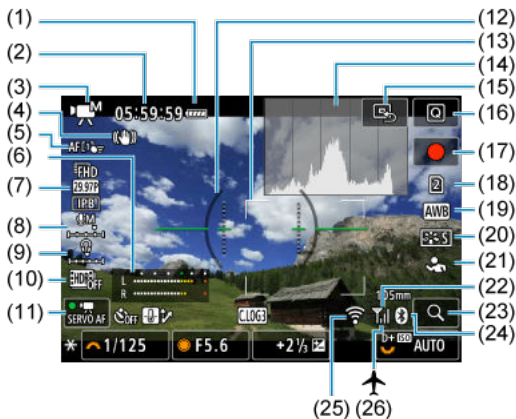

-
- | | |
|------|---|
| (1) | Battery level |
| (2) | Movie recording time available/Elapsed recording time |
| (3) | Shooting mode |
| (4) | Image Stabilizer (IS mode) |
| (5) | AF area |
| (6) | Audio recording level indicator (manual input) |
| (7) | Movie recording size |
| (8) | Audio recording level (manual input) |
| (9) | Headphone volume |
| (10) | HDR movie |
| (11) | Movie Servo AF |
| (12) | Electronic level |
| (13) | AF point (Flexible Zone AF 1) |
| (14) | Histogram (Brightness/RGB) |
| (15) | Set AF point to center |
| (16) | Quick Control button |
| (17) |  Movie shooting button |
| (18) | Card for recording/playback |
| (19) | White balance/White balance correction |
| (20) | Picture Style |
| (21) | Subject to detect |
| (22) | Wi-Fi signal strength |
| (23) | Magnify button |
| (24) | Bluetooth function |
| (25) | Wi-Fi function |
| (26) | Airplane mode |
-



- | | |
|------|--|
| (27) | Overheat control |
| (28) | Movie self-timer |
| (29) | AE lock |
| (30) | Shutter speed |
| (31) | Aperture value |
| (32) | Canon Log |
| (33) | Overheating |
| (34) | Overheating warning |
| (35) | Focal length |
| (36) | ISO speed |
| (37) | Highlight tone priority |
| (38) | Exposure compensation |
| (39) | Exposure level indicator (metering levels) |

! Caution

- You can specify the information displayed in response to pressing the <INFO> button (i).
- The electronic level is not displayed when the camera is connected via HDMI to a television.
- The electronic level, grid lines, and histogram cannot be displayed during movie recording (and if they are currently displayed, recording a movie will clear the display).
- Time available per recording changes to elapsed time after movie recording begins.

**Note**

- Other icons may be displayed temporarily after setting adjustments.

Playback Screen

Each time you press the <INFO> button, the information display will change.

- The display will show only the settings currently applied.

Basic information display for still photos

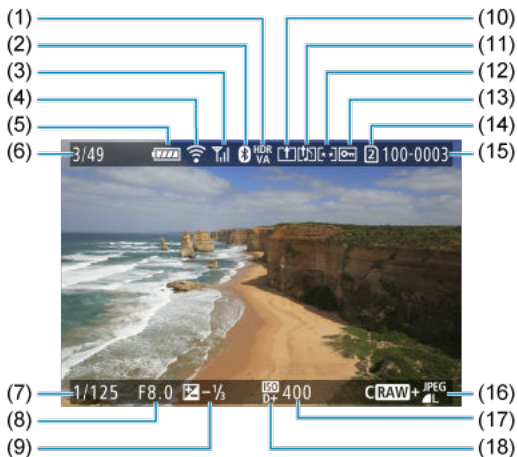

(1)	HDR View Assist
(2)	Bluetooth function
(3)	Wi-Fi signal strength
(4)	Wi-Fi function
(5)	Battery level
(6)	Current image no./Total images/No. of images found
(7)	Shutter speed
(8)	Aperture value
(9)	Exposure compensation amount
(10)	Already sent to a computer/smartphone
(11)	Voice memo
(12)	Rating
(13)	Image protection
(14)	Card no.
(15)	Folder no.-File no.
(16)	Image quality/Edited image/Cropping/Frame Grab
(17)	ISO speed
(18)	Highlight tone priority

 **Caution**

- If the image was taken by another camera, certain shooting information may not be displayed.
- It may not be possible to play back images taken with this camera on other cameras.

Detailed information display for still photos

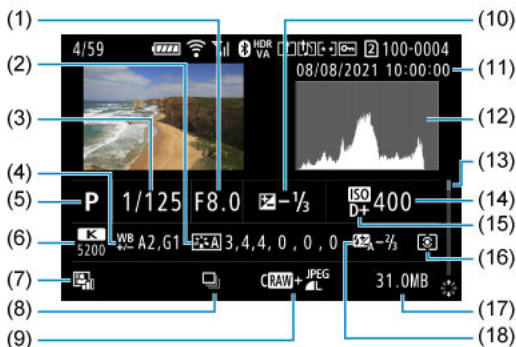

- | | |
|------|---|
| (1) | Aperture value |
| (2) | Picture Style/Canon Log/Settings |
| (3) | Shutter speed |
| (4) | White balance correction/Bracketing |
| (5) | Shooting mode/Multiple exposure/Frame Grab |
| (6) | White balance |
| (7) | Auto Lighting Optimizer |
| (8) | First image of scene |
| (9) | Image quality/Edited image/Cropping |
| (10) | Exposure compensation amount |
| (11) | Shooting date and time |
| (12) | Histogram (Brightness/RGB) |
| (13) | Scroll bar |
| (14) | ISO speed |
| (15) | Highlight tone priority |
| (16) | Metering mode |
| (17) | File size |
| (18) | Flash exposure compensation amount/Bounce/HDR shooting/Multi Shot Noise Reduction |

* For simplicity, explanations are omitted for items also included in [Basic information display for still photos](#), which are not shown here.

* For images captured in RAW+JPEG/HEIF shooting, indicates RAW file sizes.

* Lines indicating the image area are displayed for images taken with the aspect ratio set (Ⓜ) and with RAW or RAW+JPEG set for image quality.

* Images with added cropping information are displayed cropped.

* During flash photography without flash exposure compensation, (⚡) will be displayed.

* (⚡) indicates images shot with bounce flash photography.

* The dynamic range adjustment amount is shown for images captured in HDR shooting.

* (Ⓜ) indicates images captured in multiple-exposure shooting.

* [] indicates images processed with Multi Shot Noise Reduction.

* [] indicates test shots for time-lapse movies.

* [] indicates images created and saved by performing RAW image processing, resizing, cropping, HEIF to JPEG conversion, or frame-grabbing.

* [] indicates images cropped and then saved.

* JPEGs converted from HEIF images are labeled with [] (when captured on this camera with firmware Ver. 1.2.0 or later installed).

Detailed information display for movies

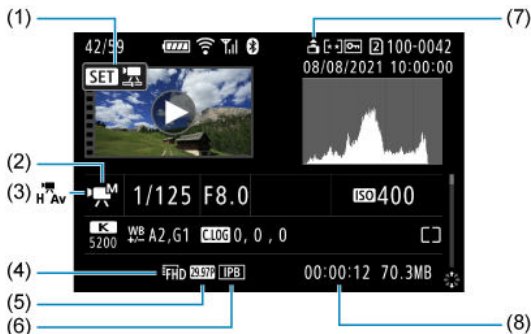

- | | |
|-----|-------------------------------|
| (1) | Movie playback |
| (2) | Movie recording mode |
| (3) | High Frame Rate |
| (4) | Movie recording size |
| (5) | Video frame rate |
| (6) | Movie compression method |
| (7) | Movie orientation information |
| (8) | Recording time/Time code |

* For simplicity, explanations are omitted for items that are also included in [Basic information display for still photos](#) and [Detailed information display for still photos](#), which are not shown here.

Note

- During movie playback, "*" is displayed for the **[Fineness]** and **[Threshold]** parameters of **[Sharpness]** in **[Picture Style]**.

Specifications

Type

Type: Digital single-lens non-reflex AF/AE camera

Lens mount: Canon RF mount

Compatible lenses: Canon RF lens group

* Using mount adapter EF-EOS R: Canon EF or EF-S lenses (excluding EF-M lenses)

Lens focal length: Same as the focal length indicated on the lens

* Using RF-S or EF-S lenses: Approx. 1.6 times the indicated focal length

Image sensor

Type: Full-frame back-illuminated stacked CMOS sensor

Effective pixels*1*2	Max. approx. 24.1 megapixels
Total pixels*1	Approx. 26.7 megapixels
Screen size	Approx. 36.0 × 24.0 mm
Dual Pixel CMOS AF	Supported

* 1: Rounded to the nearest 100,000.

* 2: Using RF or EF lenses.

The effective pixel count may be lower with certain lenses and image processing.

Recording system

Image recording format: Compliant to Design rule for Camera File system 2.0 and Exif 2.31*

* Supports time difference information

Image type and extension

Image type		Extension
Still photos	JPEG	JPG
	HEIF	HIF
	RAW	CR3
	C-RAW	
Movies	ALL-I, IPB	MP4
	RAW	CRM

Still photo recording

Still photo pixel count

Image size		Resolution (Pixels)				
		Aspect ratio				
		3:2	1.6× (crop) ^{*1}	1:1	4:3	16:9
JPEG/HEIF	L	24.0 megapixels (6000 × 4000)	Approx. 9.3 megapixels (3744 × 2496)	16.0 megapixels (4000 × 4000)	Approx. 21.3 megapixels ^{*2} (5328 × 4000)	Approx. 20.2 megapixels ^{*2} (6000 × 3368)
	M	Approx. 10.6 megapixels (3984 × 2656)		Approx. 7.1 megapixels (2656 × 2656)	Approx. 9.5 megapixels (3552 × 2664)	Approx. 8.9 megapixels ^{*2} (3984 × 2240)
	S1	Approx. 5.9 megapixels (2976 × 1984)		Approx. 3.9 megapixels (1984 × 1984)	Approx. 5.3 megapixels (2656 × 1992)	Approx. 5.0 megapixels ^{*2} (2976 × 1680)
	S2	Approx. 3.8 megapixels (2400 × 1600)	Approx. 3.8 megapixels (2400 × 1600)	Approx. 2.6 megapixels (1600 × 1600)	Approx. 3.4 megapixels ^{*2} (2112 × 1600)	Approx. 3.2 megapixels ^{*2} (2400 × 1344)
RAW	RAW/CRAW	24.0 megapixels (6000 × 4000)	Approx. 9.3 megapixels (3744 × 2496)	24.0 megapixels ^{*2} (6000 × 4000)		

* Values for recorded pixels are rounded off to the nearest 100,000th.

* RAW/C-Raw images are generated in [3:2], and the set aspect ratio is appended.

* JPEG images are generated in the set aspect ratio.

* These aspect ratios (M / S1 / S2) and pixel counts also apply to resizing.

* 1: Angle of view of approx. 1.6 times the focal length.

* 2: Aspect ratios are slightly different for these image sizes.

Still photo file size / Number of shots available / Maximum burst for continuous shooting

When using the electronic shutter

Image quality		File size [Approx. MB]	Available shots [Approx.] ^{*1}	Maximum burst [Approx.]		
				CFexpress card ^{*1}	SD card ^{*2}	SD card ^{*3} [Hi- speed]
JPEG ^{*4}	L	8.7	37560	540	410	530
	M	4.7	67860	530	530	530
	S1	3.2	99010	530	530	530
	S2	1.9	163960	530	530	530
HEIF ^{*5}	L	8.1	34800	460	420	450
	M	4.7	59400	580	560	560
	S1	3.4	85030	590	560	560
	S2	1.8	143310	590	560	570
RAW ^{*4}	RAW	29.3	11860	150	150	150
	CRAW	15.1	24130	420	320	420
RAW+JPEG ^{*4}	RAW +L	29.3+8.7	9010	150	140	150
	CRAW +L	15.1+8.7	14690	400	260	330
RAW+HEIF ^{*5}	RAW +L	29.1+8.1	7970	150	140	150
	CRAW +L	15.4+8.1	12240	290	290	290

* 1: Number of shots available and maximum burst for CFexpress cards apply to 325 GB CFexpress cards conforming to Canon testing standards.

* 2: Maximum burst for SD cards applies to 32 GB UHS-I SD cards conforming to Canon testing standards.

* 3: Maximum burst for Hi-speed SD cards applies to 32 GB UHS-II SD cards conforming to Canon testing standards.

* 4: When set to [HDR shooting **HDR PQ**: Disable].

* 5: When set to [HDR shooting **HDR PQ**: Enable].

* Maximum burst as measured under conditions conforming to Canon testing standards (High-speed continuous shooting+ in One-Shot AF mode, JPEG/HEIF image quality of 8, ISO 100, and Standard Picture Style).

* File size, number of shots available, and maximum burst vary depending on shooting conditions (including cropping/aspect ratio, JPEG/HEIF image quality, subject, memory card brand, ISO speed, Picture Style, and Custom Functions).

When using the mechanical shutter/electronic first-curtain

Image quality		File size [Approx. MB]	Available shots [Approx.]* ¹	Maximum burst [Approx.]		
				CFexpress card* ¹	SD card* ²	SD card* ³ [Hi- speed]
JPEG* ⁴	L	See " When using the electronic shutter. "	1,000 or more	980	1,000 or more	
	M		1,000 or more	1,000 or more	1,000 or more	
	S1		1,000 or more	1,000 or more	1,000 or more	
	S2		1,000 or more	1,000 or more	1,000 or more	
HEIF* ⁵	L		1,000 or more	950	1,000 or more	
	M		1,000 or more	1,000 or more	1,000 or more	
	S1		1,000 or more	1,000 or more	1,000 or more	
	S2		1,000 or more	1,000 or more	1,000 or more	
RAW* ⁴	RAW		1,000 or more	160	290	
	CRRAW		1,000 or more	410	1,000 or more	
RAW+JPEG* ⁴	RAW+L		1,000 or more	140	140	
	CRRAW+L		1,000 or more	300	770	
RAW+HEIF* ⁵	RAW+L		300	150	170	
	CRRAW+L		600	310	600	

* 1: Number of shots available and maximum burst for CFexpress cards apply to 325 GB CFexpress cards conforming to Canon testing standards.

* 2: Maximum burst for SD cards applies to 32 GB UHS-I SD cards conforming to Canon testing standards.

* 3: Maximum burst for Hi-speed SD cards applies to 32 GB UHS-II SD cards conforming to Canon testing standards.

* 4: When set to [HDR shooting **HDR PQ**: Disable].

* 5: When set to [HDR shooting **HDR PQ**: Enable].

* Maximum burst as measured under conditions conforming to Canon testing standards (High-speed continuous shooting+ in One-Shot AF mode, JPEG/HEIF image quality of 8, ISO 100, and Standard Picture Style).

* File size, number of shots available, and maximum burst vary depending on shooting conditions (including cropping/aspect ratio, JPEG/HEIF image quality, subject, memory card brand, ISO speed, Picture Style, and Custom Functions).

Movie recording

Movie recording format: MP4, RAW

Estimated recording time, movie bit rate, and file size

Canon Log 3: Off, HDR PQ: Off

Movie recording size			Total recording time (Approx.)			Movie bit rate (Approx. Mbps)	File size (Approx. MB/min.)
			64 GB	256 GB	1 TB		
6K RAW	59.94 fps 50.00 fps	RAW (Standard)	3 min.	13 min.	50 min.	2600	18728
		RAW (Light)	4 min.	18 min.	1 hr. 13 min.	1800	13006
	29.97 fps 25.00 fps	RAW (Standard)	4 min.	16 min.	1 hr. 6 min.	2000	14376
		RAW (Standard)	5 min.	21 min.	1 hr. 22 min.	1600	11503
	29.97 fps 25.00 fps	RAW (Light)	9 min.	37 min.	2 hr. 26 min.	900	6508
		RAW (Light)	11 min.	46 min.	3 hr. 3 min.	720	5209
4K DCI	59.94 fps 50.00 fps	ALL-I	9 min.	36 min.	2 hr. 21 min.	940	6734
		IPB (Standard)	36 min.	2 hr. 27 min.	9 hr. 35 min.	230	1656
		IPB (Light)	1 hr. 10 min.	4 hr. 40 min.	18 hr. 17 min.	120	869
	29.97 fps 25.00 fps 24.00 fps 23.98 fps	ALL-I	18 min.	1 hr. 12 min.	4 hr. 42 min.	470	3373
		IPB (Standard)	1 hr. 10 min.	4 hr. 40 min.	18 hr. 17 min.	120	869
		IPB (Light)	2 hr. 18 min.	9 hr. 14 min.	36 hr. 6 min.	60	440
	119.88 fps 100.00 fps	ALL-I	4 min.	18 min.	1 hr. 10 min.	1880	13447

4K UHD		59.94 fps 50.00 fps	ALL-I	9 min.	36 min.	2 hr. 21 min.	940	6734		
			IPB (Standard)	36 min.	2 hr. 27 min.	9 hr. 35 min.	230	1656		
			IPB (Light)	1 hr. 10 min.	4 hr. 40 min.	18 hr. 17 min.	120	869		
		29.97 fps 25.00 fps 23.98 fps	ALL-I	18 min.	1 hr. 12 min.	4 hr. 42 min.	470	3373		
			IPB (Standard)	1 hr. 10 min.	4 hr. 40 min.	18 hr. 17 min.	120	869		
			IPB (Light)	2 hr. 18 min.	9 hr. 14 min.	36 hr. 6 min.	60	440		
		119.88 fps 100.00 fps	ALL-I	4 min.	18 min.	1 hr. 10 min.	1880	13447		
		Full HD		59.94 fps 50.00 fps	ALL-I	47 min.	3 hr. 8 min.	12 hr. 14 min.	180	1298
					IPB (Standard)	2 hr. 18 min.	9 hr. 14 min.	36 hr. 6 min.	60	440
					IPB (Light)	3 hr. 53 min.	15 hr. 34 min.	60 hr. 49 min.	35	261
29.97 fps 25.00 fps 23.98 fps	ALL-I			1 hr. 33 min.	6 hr. 12 min.	24 hr. 16 min.	90	655		
	IPB (Standard)			4 hr. 30 min.	18 hr. 2 min.	70 hr. 27 min.	30	226		
	IPB (Light)			11 hr. 35 min.	46 hr. 23 min.	181 hr. 13 min.	12	88		
239.76 fps 200.00 fps	ALL-I			12 min.	50 min.	3 hr. 16 min.	680	4864		
119.88 fps 100.00 fps	ALL-I			23 min.	1 hr. 34 min.	6 hr. 10 min.	360	2575		
Time-lapse movies	4K UHD			29.97 fps 25.00 fps	ALL-I	18 min.	1 hr. 12 min.	4 hr. 43 min.	470	3362
	Full HD					1 hr. 34 min.	6 hr. 19 min.	24 hr. 41 min.	90	644

* Bit rate only applies to video output, not audio or metadata.

* The same values apply to 4K DCI, 4K UHD, and Full HD whether **[Movie cropping]** is set to **[Enable]** or **[Disable]**.

* Movie recording stops when the maximum recording time per movie is reached.

* Sound is not recorded for approx. the last two frames when the compression method for movie recording quality is IPB or IPB Light (audio: AAC) or **[C.Fn 6 Audio compression]** is set to **[Enable]**. Moreover, the video and sound may be slightly out of sync when movies are played back in Windows.

Canon Log 3: On, or HDR PQ: On

Movie recording size			Total recording time (Approx.)			Movie bit rate (Approx. Mbps)	File size (Approx. MB/min.)
			64 GB	256 GB	1 TB		
6K RAW	59.94 fps 50.00 fps	RAW (Standard)	3 min.	13 min.	50 min.	2600	18728
		RAW (Light)	4 min.	18 min.	1 hr. 13 min.	1800	13006
	29.97 fps 25.00 fps	RAW (Standard)	4 min.	16 min.	1 hr. 6 min.	2000	14376
		RAW (Standard)	5 min.	21 min.	1 hr. 22 min.	1600	11503
	29.97 fps 25.00 fps	RAW (Light)	9 min.	37 min.	2 hr. 26 min.	900	6508
		RAW (Light)	11 min.	46 min.	3 hr. 3 min.	720	5209
4K DCI	59.94 fps 50.00 fps	ALL-I	8 min.	34 min.	2 hr. 13 min.	1000	7164
		IPB (Standard)	24 min.	1 hr. 39 min.	6 hr. 30 min.	340	2443
		IPB (Light)	49 min.	3 hr. 18 min.	12 hr. 57 min.	170	1227
	29.97 fps 25.00 fps 24.00 fps 23.98 fps	ALL-I	18 min.	1 hr. 12 min.	4 hr. 42 min.	470	3373
		IPB (Standard)	49 min.	3 hr. 18 min.	12 hr. 57 min.	170	1227
		IPB (Light)	1 hr. 38 min.	6 hr. 34 min.	25 hr. 40 min.	85	619
119.88 fps 100.00 fps	ALL-I	4 min.	18 min.	1 hr. 10 min.	1880	13447	
4K UHD	59.94 fps 50.00 fps	ALL-I	8 min.	34 min.	2 hr. 13 min.	1000	7164
		IPB (Standard)	24 min.	1 hr. 39 min.	6 hr. 30 min.	340	2443
		IPB (Light)	49 min.	3 hr. 18 min.	12 hr. 57 min.	170	1227
	29.97 fps 25.00 fps 23.98 fps	ALL-I	18 min.	1 hr. 12 min.	4 hr. 42 min.	470	3373
		IPB (Standard)	49 min.	3 hr. 18 min.	12 hr. 57 min.	170	1227
		IPB (Light)	1 hr. 38 min.	6 hr. 34 min.	25 hr. 40 min.	85	619
119.88 fps 100.00 fps	ALL-I	4 min.	18 min.	1 hr. 10 min.	1880	13447	

Full HD		59.94 fps 50.00 fps	ALL-I	36 min.	2 hr. 27 min.	9 hr. 35 min.	230	1656
			IPB (Standard)	1 hr. 33 min.	6 hr. 12 min.	24 hr. 16 min.	90	655
			IPB (Light)	2 hr. 45 min.	11 hr. 2 min.	43 hr. 7 min.	50	369
		29.97 fps 25.00 fps 23.98 fps	ALL-I	1 hr. 2 min.	4 hr. 9 min.	16 hr. 16 min.	135	977
			IPB (Standard)	3 hr. 3 min.	12 hr. 13 min.	47 hr. 45 min.	45	333
			IPB (Light)	5 hr. 1 min.	20 hr. 7 min.	78 hr. 37 min.	28	202
		239.76 fps 200.00 fps	ALL-I	9 min.	36 min.	2 hr. 21 min.	940	6723
		119.88 fps 100.00 fps	ALL-I	18 min.	1 hr. 12 min.	4 hr. 43 min.	470	3362
		Time-lapse movies	4K UHD	29.97 fps 25.00 fps	ALL-I	18 min.	1 hr. 12 min.	4 hr. 43 min.
Full HD	1 hr. 3 min.		4 hr. 12 min.			16 hr. 27 min.	135	966

* Bit rate only applies to video output, not audio or metadata.

* The same values apply to 4K DCI, 4K UHD, and Full HD whether **[Movie cropping]** is set to **[Enable]** or **[Disable]**.

* Movie recording stops when the maximum recording time per movie is reached.

* Sound is not recorded for approx. the last two frames when the compression method for movie recording quality is IPB or IPB Light (audio: AAC) or **[C.Fn 6 Audio compression]** is set to **[Enable]**. Moreover, the video and sound may be slightly out of sync when movies are played back in Windows.

Card performance requirements (Movie recording) [Write/Read speed]

Movie recording size			CFexpress card	SD card		
			8 bit / 10 bit	8 bit	10 bit	
6K RAW	59.94 fps 50.00 fps	RAW (Standard)	CFexpress 2.0 Type-B [400 MB/s or higher]			
		RAW (Light)				
	29.97 fps 25.00 fps	RAW (Standard)				
	24.00 fps 23.98 fps	RAW (Standard)	CFexpress 2.0 Type-B [200 MB/s or higher]			
	29.97 fps 25.00 fps	RAW (Light)				
	24.00 fps 23.98 fps	RAW (Light)				
4K	59.94 fps 50.00 fps	ALL-I	CFexpress 2.0	UHS Speed Class 3 or higher	Video Speed Class V60 or higher	
		IPB (Standard)				
		IPB (Light)				
	29.97 fps 25.00 fps 24.00 fps 23.98 fps	ALL-I	CFexpress 2.0	Video Speed Class V60 or higher		
		IPB (Standard)		UHS Speed Class 3 or higher		
		IPB (Light)				
119.88 fps 100.00 fps	ALL-I	CFexpress 2.0 Type-B [400 MB/s or higher]				
Full HD	59.94 fps 50.00 fps	ALL-I	CFexpress 2.0	UHS Speed Class 3 or higher		
		IPB (Standard)		SD Speed Class 10 or higher	UHS Speed Class 3 or higher	
		IPB (Light)				
	29.97 fps 25.00 fps 23.98 fps	ALL-I	CFexpress 2.0	UHS Speed Class 3 or higher		
		IPB (Standard)		SD Speed Class 6 or higher		
		IPB (Light)		SD Speed Class 4 or higher		
	239.76 fps 200.00 fps	ALL-I	CFexpress 2.0 Type-B [200 MB/s or higher]	Video Speed Class V90 or higher		
	119.88 fps 100.00 fps	ALL-I	CFexpress 2.0	Video Speed Class V60 or higher		
Time-lapse movies	4K UHD	29.97 fps 25.00 fps	ALL-I	CFexpress 2.0	Video Speed Class V60 or higher	Video Speed Class V60 or higher
	Full HD				UHS Speed Class 3 or higher	UHS Speed Class 3 or higher

Built-in and external microphones

Built-in microphone: Monaural microphone

External microphone: Connected to the multi-function shoe or 3.5 mm diameter stereo mini jack

Recording media

Recording media:

CFexpress memory card

* Type B

* VPG400 support

SD memory card

* Compatible with UHS-II

Autofocus

Focusing method: Dual Pixel CMOS AF

Focusing operation

	Still photo shooting	Movie recording
AF operation	One-Shot AF Servo AF	One-Shot AF Movie Servo AF
Manual focus (MF)	Supported	Supported

Lens compatibility based on AF area: Refer to the Canon website ([🌐](#))

Number of AF area available for automatic selection

AF area		Horizontal: Approx. 100%, Vertical: Approx. 100%
Number of AF zones	Still photos	Max. 1053 zones (39 × 27)
	Movies	Max. 819 zones (39 × 21)

* May vary depending on settings.

Selectable positions for AF point

AF area		Horizontal: Approx. 90%, Vertical: Approx. 100%
Numbers of positions	Still photos	Max. 4779 positions (81 × 59)
	Movies	Max. 3969 positions (81 × 49)

* When set to [1-point AF] and selected using the Multi-controller.

Focusing brightness range (still photos): EV -7.5 to 20 (with an $f/1.2$ lens,* center AF point, and One-Shot AF, at room temperature, and ISO 100)

* Except RF lenses with a Defocus Smoothing (DS) coating

Focusing brightness range (movies): EV -4.5 to 20 (with an $f/1.2$ lens,* center AF point, and One-Shot AF, at room temperature, ISO 100, and 29.97 fps)

* Except RF lenses with a Defocus Smoothing (DS) coating

Eye control

The feature can be used in still photo shooting but not movie recording.

Detection type: Line-of-sight detection using corneal reflections (Purkinje images) acquired using infrared LEDs and an image of the user's pupil

Viewfinder

Type: OLED color electronic viewfinder

Screen size: Approx. 12.7 mm (0.5 inch)

Dot count: Approx. 5,760,000 dots

Magnification / angle of view: Approx. $0.76\times$ / Approx. 35.7° (with 50 mm lens at infinity, -1 m^{-1})

Coverage: Approx. 100% (at L image size, an aspect ratio of 3:2, and approx. 23 mm eyepoint)

Eyepoint: Approx. 23 mm (at -1 m^{-1} from eyepiece lens end)

Dioptic adjustment: Approx. -4.0 to $+2.0\text{ m}^{-1}$ (dpt)

Screen

Type: TFT color, liquid-crystal monitor

Screen size: Approx. 80.1 mm (3.2 inch) (aspect ratio of 3:2)

Dot count: Approx. 4,150,000 dots

Angle of view: Approx. 170° vertically and horizontally

Coverage: Approx. 100% vertically and horizontally (at L image size and an aspect ratio of 3:2)

Touch-screen: Capacitive sensing

LCD panel

Type: Reflective memory LCD

Display format: Dot-matrix display

Dot count: 128×128 dots

HDMI output

HDMI video / audio output: HDMI micro OUT terminal (Type D)

* HDMI CEC not supported

HDMI resolution: Auto / 1080p

Exposure control

Metering functions under various shooting conditions

Item		Still photo shooting	Movie recording
Metering sensor		384-zone (24×16) metering using image sensor output signals*1	
Shooting mode		Fv / P / Tv / Av / M / BULB / C1 / C2 / C3	P / Tv / Av / M / C1 / C2 / C3
Metering mode	Evaluative metering	○	○ * When faces are detected
	Partial metering	○ * Approx. 5.9% in the center of the screen	
	Spot metering	○ * Approx. 2.9% in the center of the screen	
	Center-weighted average metering	○	○ * When no faces are detected * When set to Canon Log 3
Metering brightness range (at room temperature, ISO 100)		EV -3 to 20	EV -1 to 20

* 1: Same applies when set to [1.6x (crop)].

ISO speed (recommended exposure index) in still photo shooting

Manual ISO speed setting for still photos

	ISO speed
Normal ISO speed	ISO 100–102400 (in 1/3 or 1-stop increments)
Expanded ISO speed	L (equivalent to ISO 50), H (equivalent to ISO 204800)

* When set to [Highlight tone priority], the available manual setting range is ISO 200–102400.

* Expanded ISO speeds cannot be set in HDR mode or for HDR shooting (HDR PQ).

Manual ISO speed setting range for still photos

ISO speed range	ISO speed
Minimum	L (equivalent to ISO 50) to ISO 102400 (in 1-stop increments)
Maximum	ISO 100 to H (equivalent to ISO 204800, in 1-stop increments)

ISO Auto setting range for still photos

Auto range	ISO speed
Minimum	ISO 100–51200 (in 1-stop increments)
Maximum	ISO 200–102400 (in 1-stop increments)

ISO Auto details for still photos

Shooting mode	No flash	Using flash
P	ISO 100* ¹ , * ² -102400* ²	ISO 100* ¹ , * ² -6400* ² , * ³
Tv		
Av		
M		
BULB	ISO 400* ⁴	ISO 400* ⁴

* 1: ISO 200 when set to **[Highlight tone priority: Enable/Enhanced]**.

* 2: Varies depending on the **[Maximum]** and **[Minimum]** settings for **[Auto range]**.

* 3: ISO 1600 when using a lens that is not compatible with ¹Variable control of maximum ISO Auto limit for E-TTL¹.

* 4: If outside the setting range, changed to the value most close to ISO 400.

Variable control of maximum ISO Auto limit for E-TTL: Supported

ISO speed (recommended exposure index) in movie recording

Manual ISO speed setting for movies (in M mode)

	Canon Log 3	ISO speed
Normal ISO speed	Off	ISO 100–25600 (in 1/3 or 1-stop increments)
	On	ISO 800–25600 (in 1/3 or 1-stop increments)
Expanded ISO speed	Off	H (equivalent to ISO 32000, 40000, 51200, 64000, 80000, or 102400)
	On	L (equivalent to ISO 100, 125, 160, 200, 250, 320, 400, 500, or 640) H (equivalent to ISO 32000, 40000, 51200, 64000, 80000, or 102400)

* Maximum ISO speed when set manually corresponds to the **[ISO speed range]** setting.

* When set to **[Highlight tone priority]**, the setting range is ISO 200–25600.

* Expanded ISO speeds are not available in HDR PQ, HDR, RAW or High-frame rate movie recording.

* H expansion is not available when set to RAW movie recording with Canon Log 3, but L expansion is available.

* The default setting range when set to Canon Log 3 is L and ISO 800–25600.

Automatic ISO speed setting for movies (in P / Tv / Av mode, and in M mode with ISO Auto)

	Canon Log 3	ISO speed
Normal ISO speed	Off	ISO 100–25600 (in 1/3 or 1-stop increments)
	On	ISO 800–25600 (in 1/3 or 1-stop increments)
Expanded ISO speed	Off	H (equivalent to ISO 32000, 40000, 51200, 64000, 80000, or 102400)
	On	

* Maximum ISO speed when set automatically corresponds to the **[Max for Auto]** setting.

* When set to **[Highlight tone priority]**, the setting range is ISO 200–25600.

* Expanded ISO speeds are not available in HDR PQ, HDR, RAW or High-frame rate movie recording.

Manual ISO speed setting range for movies

ISO speed range	ISO speed
Minimum	ISO 100–25600 or H (equivalent to ISO 51200, in 1-stop increments)
Maximum	ISO 200–25600 or H (equivalent to ISO 51200 or 102400, in 1-stop increments)

Maximum ISO Auto setting for movies

	ISO speed
Max for Auto	ISO 6400–25600 or H (equivalent to ISO 51200 or 102400, in 1-stop increments)
[Time-lapse movie] Max for Auto	ISO 400-25600

Shutter

Still photo shooting

Type:

Rolling shutter, using the image sensor
Electronically controlled focal-plane shutter

Shutter mode: Mechanical shutter / Electronic 1st-curtain / Electronic shutter

Shutter speed

Mechanical shutter / Electronic 1st-curtain	1/8000 to 30 sec. (in 1/3 or 1/2-stop increments), bulb exposures
Electronic shutter	1/64000 sec., 1/32000 sec., 1/16000 sec., 1/12800 sec., 1/10000 sec., or 1/8000 sec. to 30 sec. (in 1/3 or 1/2-stop increments), bulb exposures

* In electronic shutter shooting, shutter speeds of 1/10000 sec. or faster are only available in Tv or M mode (up to 1/8000 sec. in Fv, P, or Av mode).

* Adjustments by the camera when the shutter speed is set to 1/64000 or 1/32000 sec. in electronic shutter shooting may involve the aperture value or ISO speed in some shooting conditions, because exposure cannot be controlled in 1/3 or 1/2-stop increments.

* Maximum shutter speed is 1/8000 sec. in HDR mode or with focus bracketing or high-speed sync, or when set to maintain the same exposure when the aperture value changes.

X-sync speed

Mechanical shutter	1/200 sec.
Electronic 1st curtain	1/250 sec.
Electronic shutter	1/180 sec.

Movie recording

Type: Rolling shutter, using the image sensor

Shutter speed: 1/4000–1/25* sec.

* Varies by frame rate; for details, see [Shutter Speed](#).

Movies in Tv or M mode: 1/4000–1/8* sec.

* Varies by shooting mode and frame rate.

* Minimum speed is 1/125 sec. (NTSC) or 1/100 sec. (PAL) when set to **[High Frame Rate: Enable]**.

Image stabilization (IS mode): Provided

Drive

Drive mode and continuous shooting speed

Drive modes	AF operation	Mechanical shutter	Electronic 1st curtain	Electronic shutter
Single shooting		○	○	○
High-speed continuous shooting+	One-Shot AF	Max. approx. 12 shots/sec.	Max. approx. 12 shots/sec.	Max. approx. 30 shots/sec.
	Servo AF			
High-speed continuous shooting	One-Shot AF	Max. approx. 6.0 shots/sec.	Max. approx. 8.0 shots/sec.	Max. approx. 15 shots/sec.
	Servo AF			
Low-speed continuous shooting	One-Shot AF	Max. approx. 3.0 shots/sec.	Max. approx. 3.0 shots/sec.	Max. approx. 3.0 shots/sec.
	Servo AF			
Custom high-speed continuous shooting	One-Shot AF			Max. approx. 195 shots/sec.
	Servo AF			
Self-timer: 10 sec. / remote control		○	○	○
Self-timer: 2 sec. / remote control		○	○	○

External flash

Accessory shoe contacts: 21 pins for accessories compatible with the multi-function shoe, 5 pins for X-sync and communication

Playback

Item	Still photo	Movie
AF point display	○	
Playback grid	Off / 3×3 / 6×4 / 3×3+diag	
Magnified view	1.5×–10× (15 levels)	
Setting image search conditions	Search conditions Rating / Date / Folder / Protection / Type of file (1) / Type of file (2)	
Ratings	OFF / ★ to ★★★★★ Select images / Select range / All images in folder / All images on card / All found images	
Protect images	Select images / Select range / All images in folder / Unprotect all images in folder / All images on card / Unprotect all images on card / All found images / Unprotect all found images	
In-camera RAW image processing	Supported	
Resizing	Supported	
Cropping	Supported	

Frame grab from 4K movies

Individual frames in 4K movies recorded with the camera can be saved as JPEG or HEIF still photos.

4K	DCI	Approx. 8.8 megapixels (4096 × 2160)
	UHD	Approx. 8.3 megapixels (3840 × 2160)

* Frame grab is not available for RAW movies or Canon Log 3 movies.

* From normal movies, still photos are saved as JPEGs, and from HDR PQ movies, as HEIF images.

* Frame grabbing from 4K ALL-I, IPB (Std), and IPB (Light) is supported.

* In-camera resizing or cropping is not supported for extracted still photos.

Print order (DPOF)

Compliant with DPOF Version 1.1

External interface

Digital terminal

Terminal type: USB Type-C™

Transmission: SuperSpeed Plus USB (USB 3.2 Gen 2) equivalent

Applications:

For computer communication / smartphone communication

For in-camera charging with USB Power Adapter PD-E1

* Powering the camera while using PD-E1 is not supported.

Ethernet terminal: RJ-45 terminal

HDMI output terminal: HDMI micro OUT terminal (Type D)

External microphone input terminal: Compatible with 3.5 mm stereo mini plugs, plug-in power

Headphone terminal: Compatible with 3.5 mm stereo mini plugs

Remote control terminal: N3 type terminal

Power source

Battery

Compatible battery packs	LP-E19
Quantity used	1

USB charging: Using USB Power Adapter PD-E1

AC power source

AC adapter	AC-E19
DC coupler	DR-E19

Number of shots available

Shooting method	Temperature	Available shots (Approx.)	
		Power saving	Smooth
Viewfinder	+23°C / 73°F	620	440
Screen		860	760

* Using a new, fully charged LP-E19 and recording to an SD card, based on CIPA guidelines.

Available operating time

Conditions of use		Temperature	Available operating time
Time available for bulb exposure		+23°C / 73°F	Approx. 8 hr. 30 min.
Time available for Live View shooting * Using the screen		+23°C / 73°F	Approx. 5 hr. 40 min.
Time available for movie recording * Movie Servo AF: Disable	6K RAW movies (29.97 fps)	+23°C / 73°F	Approx. 3 hr. 10 min.
		0°C / 32°F	Approx. 3 hr.
	4K DCI	+23°C / 73°F	Approx. 3 hr. 20 min.
		0°C / 32°F	Approx. 3 hr. 10 min.
	Full HD	+23°C / 73°F	Approx. 5 hr. 20 min.
		0°C / 32°F	Approx. 5 hr.
Time available for continuous playback	Movies (normal playback)	+23°C / 73°F	Approx. 6 hr. 20 min.

* Using a fully charged LP-E19 and recording to a CFexpress card.

Battery information

Remaining capacity	In 1% increments 5-level indicator
Number of shots	Supported
Recharge performance	3 levels

Dimensions and weight

Dimensions

(W) × (H) × (D)	Approx. 150.0 × 142.6 × 87.2 mm
(W) × (H) × (D)	Approx. 5.91 × 5.61 × 3.43 in.

* Based on CIPA guidelines.

Weight

Body (including battery and CFexpress card) *Based on CIPA guidelines.	Approx. 1015 g	Approx. 35.80 oz.
Body only	Approx. 822 g	Approx. 29.00 oz.

* Not including body cap, eyecup, or multi-function shoe cover.

Operating environment

Operating temperature: 0–40°C / 32–104°F

Operating humidity: 85% or less

GPS

Position data	Latitude, longitude, elevation, and Coordinated Universal Time (UTC)
Position update interval	Every sec. / Every 5 sec. / Every 10 sec. / Every 15 sec. / Every 30 sec. / Every min. / Every 2 min. / Every 5 min.
Supported GPS signals	Supports the following GPS signals <ul style="list-style-type: none">• American GPS satellites• Russian GLONASS satellites• Japanese MICHIBIKI Quasi-Zenith Satellites<ul style="list-style-type: none">* Error correction functions using multiple MICHIBIKI satellites are not supported.
Log data	NMEA format One file is generated every 24 hours in the time zone set in the date and time. Users can copy log data to a computer and view the shooting locations and route traveled on a map shown on the computer.
Position data retention	10 min. / 30 min. / 1 hour / 3 hours / 6 hours / Unlimited

Wi-Fi (Wireless LAN) communication

Supporting standards (Equivalent to IEEE 802.11b/g/n/a/ac standards)

Wi-Fi standard	Transmission method	Maximum link speed
IEEE 802.11b	DS-SS modulation	11 Mbps
IEEE 802.11g	OFDM modulation	54 Mbps
IEEE 802.11n		72.2 Mbps
IEEE 802.11a		54 Mbps
IEEE 802.11ac		86.7 / 200 / 433.3 Mbps

Transmission frequency (Center frequency)

2.4 GHz band

Frequency	2412 to 2462 MHz
Channels	1 to 11 ch

5 GHz band

Frequency	5180 to 5825 MHz
Channels	36 to 165 ch

* Specifications vary by country/region.

Authentication and data encryption methods

Connection method	Authentication	Encryption
Camera access point	WPA2/WPA3-Personal	AES
	Open	Disable
Infrastructure	Open	WEP
		Disable
	Shared key	WEP
	WPA/WPA2/WPA3-Personal	TKIP AES
WPA/WPA2/WPA3-Enterprise		

Bluetooth

Standards compliance: Bluetooth Specification Version 5.0 compliant (Bluetooth Low Energy technology)

Transmission method: GFSK modulation

- All data above is based on Canon testing standards and CIPA (Camera & Imaging Products Association) testing standards and guidelines.
- Dimensions and weight listed above are based on CIPA Guidelines (except weight for camera body only).
- Product specifications and appearance are subject to change without notice.
- If a problem occurs with a non-Canon lens attached to the camera, contact the respective lens manufacturer.

Trademarks and Licensing

[✔ Trademarks](#)

[✔ About MPEG-4 Licensing](#)

[✔ Accessories](#)

Trademarks

- Adobe is a trademark of Adobe Systems Incorporated.
- Microsoft and Windows are trademarks or registered trademarks of Microsoft Corporation in the United States and/or other countries.
- App Store and macOS are trademarks of Apple Inc., registered in the U.S. and other countries.
- Google Play and Android are trademarks of Google LLC.
- IOS is a trademark or registered trademark of Cisco in the U.S. and other countries and is used under license.
- QR Code is a trademark of Denso Wave Inc.
- CFexpress is a trademark of the CFA (CompactFlash Association).
- SDXC logo is a trademark of SD-3C, LLC.
- HDMI, HDMI logo, and High-Definition Multimedia Interface are trademarks or registered trademarks of HDMI Licensing LLC.
- USB Type-C™ and USB-C™ are trademarks of USB Implementers Forum.
- The Wi-Fi CERTIFIED logo and the Wi-Fi Protected Setup mark are trademarks of the Wi-Fi Alliance.
- The Bluetooth® word mark and logos are registered trademarks owned by Bluetooth SIG, Inc. and any use of such marks by Canon Inc. is under license. Other trademarks and trade names are those of their respective owners.
- All other trademarks are the property of their respective owners.



About MPEG-4 Licensing

"This product is licensed under AT&T patents for the MPEG-4 standard and may be used for encoding MPEG-4 compliant video and/or decoding MPEG-4 compliant video that was encoded only (1) for a personal and non-commercial purpose or (2) by a video provider licensed under the AT&T patents to provide MPEG-4 compliant video. No license is granted or implied for any other use for MPEG-4 standard."

THIS PRODUCT IS LICENSED UNDER THE AVC PATENT PORTFOLIO LICENSE FOR THE PERSONAL USE OF A CONSUMER OR OTHER USES IN WHICH IT DOES NOT RECEIVE REMUNERATION TO (i) ENCODE VIDEO IN COMPLIANCE WITH THE AVC STANDARD ("AVC VIDEO") AND/OR (ii) DECODE AVC VIDEO THAT WAS ENCODED BY A CONSUMER ENGAGED IN A PERSONAL ACTIVITY AND/OR WAS OBTAINED FROM A VIDEO PROVIDER LICENSED TO PROVIDE AVC VIDEO. NO LICENSE IS GRANTED OR SHALL BE IMPLIED FOR ANY OTHER USE. ADDITIONAL INFORMATION MAY BE OBTAINED FROM MPEG LA, L.L.C. SEE [HTTP://WWW.MPEGLA.COM](http://www.mpegla.com)

* Notice displayed in English as required.

Accessories

Use of genuine Canon accessories is recommended

This product is designed to achieve optimum performance when used with genuine Canon accessories. Therefore, using this product with genuine accessories is highly recommended. Canon shall not be liable for any damage to this product and/or accidents such as malfunction, fire, etc. caused by the failure of non-genuine Canon accessories (e.g., a leakage and/or explosion of a battery). Please note that repairs arising out of the malfunction of non-genuine accessories will not be covered by the warranty for repairs, although you may request such repairs on a chargeable basis.

⚠ Caution

- Battery Pack LP-E19 is dedicated to Canon products only. Using it with an incompatible battery charger or product may result in malfunction or accidents for which Canon cannot be held liable.

Check the following website for details on compatible accessories.

- <https://cam.start.canon/H002/>

