

dji OSMO MOBILE 6

User Manual v1.6 2024.06

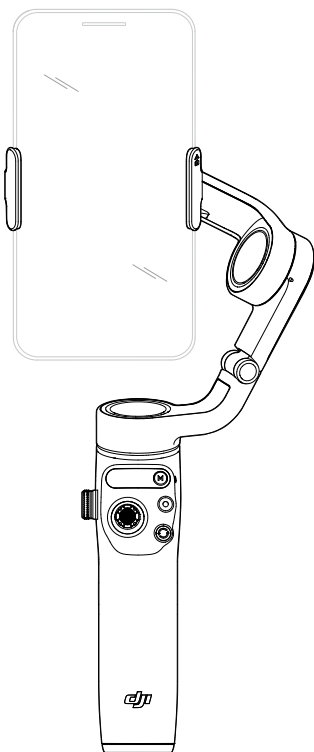



This document is copyrighted by DJI with all rights reserved. Unless otherwise authorized by DJI, you are not eligible to use or allow others to use the document or any part of the document by reproducing, transferring or selling the document. Users should only refer to this document and the content thereof as instructions to operate DJI UAV. The document should not be used for other purposes.

Searching for Keywords

Search for keywords such as “battery” and “install” to find a topic. If you are using Adobe Acrobat Reader to read this document, press Ctrl+F on Windows or Command+F on Mac to begin a search.

Navigating to a Topic

View a complete list of topics in the table of contents. Click on a topic to navigate to that section.

Printing this Document

This document supports high resolution printing.

Revision Log

Version	Date	Revisions
v1.2	2023.07	Added Extended Tilt Mode.
v1.4	2023.09	Added Parents & Kids Mode.
v1.6	2024.06	Added support for Remote Control with Watch.

Using this Manual

Legend

⚠ Important

💡 Hints and Tips

Before Use

Read the following documents before using DJI™ OSMO™ Mobile 6:

1. Safety Guidelines
2. Quick Start Guide
3. User Manual

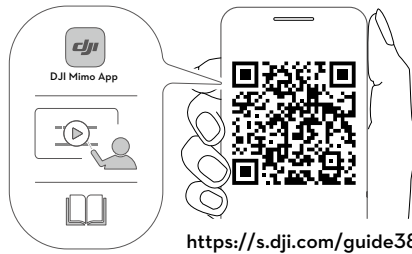

It is recommend to watch all tutorial videos on the official DJI website (www.dji.com/osmo-mobile-6/video) or in the DJI Mimo app. Read the safety guidelines and quick start guide before using for the first time. Refer to this user manual for more information.

Downloading the DJI Mimo App

Scan the QR code above to download the latest version of DJI Mimo app.

⚠ The iOS version of DJI Mimo is compatible with iOS v12.0 and later. The Android version of DJI Mimo is compatible with Android v8.0 and later.

Contents

Using this Manual	3
Legend	3
Before Use	3
Downloading the DJI Mimo App	3
Introduction	5
Overview	5
Getting Started	6
Charging	6
Attaching the Phone	6
Using Osmo Mobile 6	9
On-board Features	9
Operating Mode	12
DJI Mimo App	13
Connecting to the DJI Mimo App	14
Camera View	14
Remote Control with Watch	18
Firmware Update	20
How to Update	20
Storage	20
Specifications	21

Introduction

Boasting 3-axis stabilization and a built-in extension rod, the lightweight Osmo Mobile 6 unlocks the full potential of your mobile phone. The foldable magnetic design makes setup easier than ever, transportation and storage more convenient, and it can power on automatically once unfolded. Osmo Mobile 6 can be operated in both portrait and landscape, while the upright, underslung, side grip, and low position modes help capture the perfect shot. Take content to the next level through DJI Mimo with ActiveTrack™ 6.0, DynamicZoom, and Pano. The Story mode, Timelapse, and ShotGuides provide step-by-step tutorials according to the scenario and help generate a video that can be shared on social media.

Overview

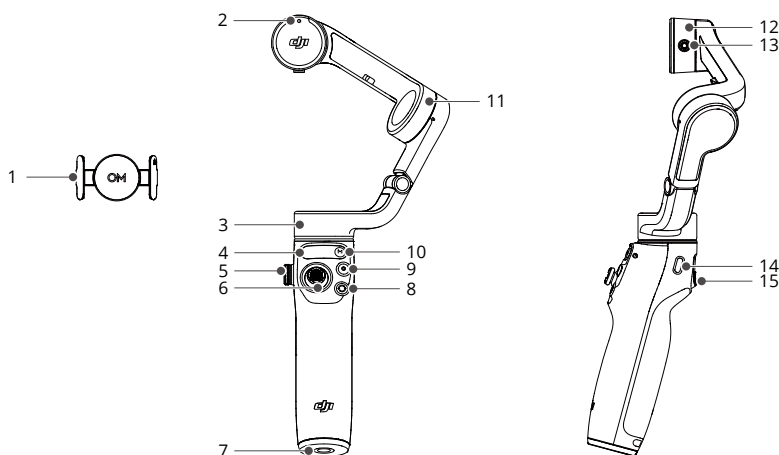

- | | | |
|-------------------------|---|---------------------------|
| 1. Magnetic Phone Clamp | 3 | 9. Shutter/Record Button |
| 2. Magnetic Alignment | | 10. Power/M Button |
| 3. Pan Motor | | 11. Tilt Motor |
| 4. Status Panel | | 12. Roll Motor |
| 5. Side Wheel | | 13. M3×0.5 Screw Hole |
| 6. Joystick | | 14. Charging Port (USB-C) |
| 7. 1/4"-20 UNC Port | | 15. Trigger |
| 8. Switch Button | | |



Osmo Mobile 6 is compatible with DJI OM Fill Light Phone Clamp and DJI Mic, which can be purchased in the DJI Store.

Getting Started

Charging

To charge Osmo Mobile 6, connect a USB adapter (not included) to the charging port using the power cable. The battery is fully charged when the battery level indicator turns off on the status panel.

Charging time: approx. 1 hour 24 minutes (tested in the environment temperature of 25° C when using a 10 W charger)

Max runtime: approx. 6 hours and 24 minutes (tested with the gimbal balanced and held steadily. This value should be taken as a reference only)

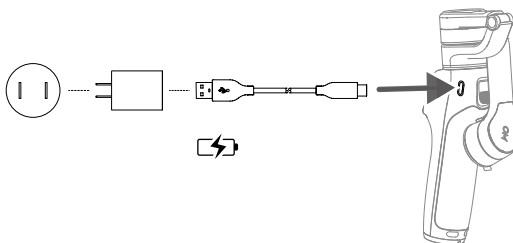

Attaching the Phone

1. Unfold the gimbal as shown. Osmo Mobile 6 will power on automatically once unfolded.

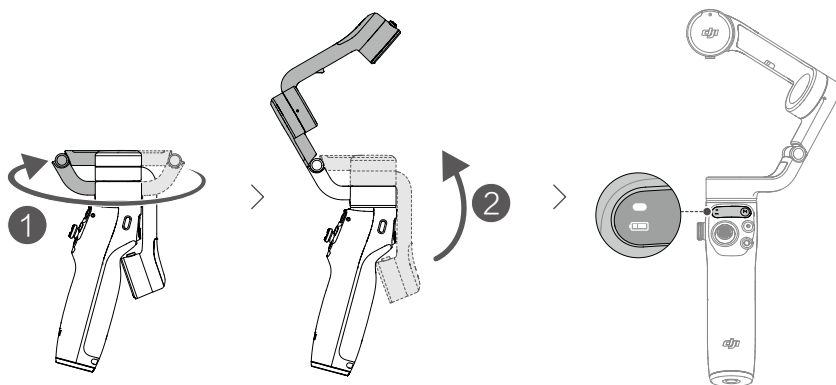

2. Attach the magnetic phone clamp in the center of the phone. The magnetic phone clamp can be stretched to adapt to the mobile phone width. The camera mark should point towards the camera of the phone.
3. Align the marks on the phone clamp and the phone clamp mounting plate. Attach the mobile phone to Osmo Mobile 6. Osmo Mobile 6 will stabilize once the gimbal mode indicator lights up on the status panel.

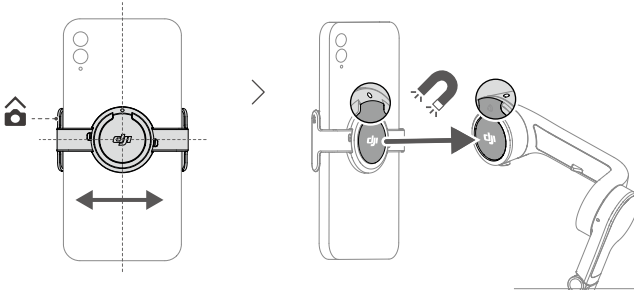



Magnetic Phone Clamp Tips

Make sure the direction of the magnet phone clamp is the same as shown in the figure above. For optimal performance, make sure the magnetic phone clamp is in the middle of the mobile phone, and the distance between the clamp arms is the same.

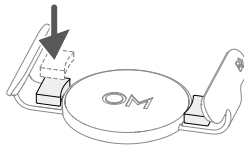

The anti-slip pads help to secure the mobile phone and the magnetic phone clamp. Attach the anti-slip pad to the magnetic phone clamp as shown in the figure below and press down firmly.



 The status indicator on the status panel will pulse red if the magnets are not aligned. Adjust the position of the magnetic clamp in that case.

4. The built-in extension rod can be extended to up to 215 mm and the angle can be adjusted from 0 to 90°.

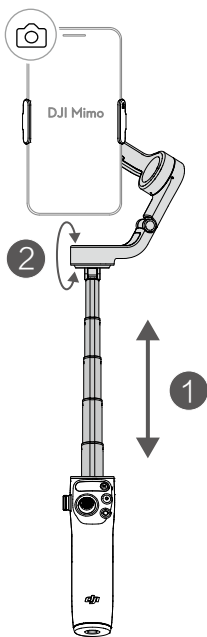

Using Osmo Mobile 6

On-board Features

Status Panel

Displays the System Status Indicator, Battery Level Indicator, and Gimbal Mode.

● System Status Indicator Descriptions

Blinking Pattern	Descriptions
Pulses red	Magnetic is not aligned
Solid yellow	Bluetooth disconnected
Solid green	Bluetooth connected
Pulses yellow or green	Standby mode
Blinks red and green alternately	Firmware updating/firmware update failed
Solid red	Abnormal status detected

🔋 Battery Level Indicator Descriptions

Blinking Pattern	Battery Level
Blinks red quickly	≤5%
Solid red	6%-19%
Solid yellow	20%-60%
Solid green	>60%

Gimbal Mode

- 📍 Follow: pan and tilt axes follow, where both the pan and tilt axes follow the movement of the grip. Suitable for scenarios when moving up and down or on a slant.
- 📍 Tilt Locked: only the pan axis follows, where only the pan axis follows the movement of the grip. Suitable for scenarios such as arc shots or moving from left to right.
- 📍 FPV: pan, tilt, and roll axes follow, where all three axes follow the movement of the grip. Suitable for shooting the first-person view.
- 📍 SpinShot: pan, tilt, and roll axes follow. The joystick can be used to control the roll axis rotation. SpinShot enables footage to be shot while rotating the camera 360°. This is suitable for shooting push, pull, and down.



M Button

When powered off

With the gimbal folded, press once or press and hold: check the battery level

With the gimbal unfolded, press once: power on

When powered on

Press once: switch between gimbal modes

Press three times: enter standby mode (press any button to exit)

Press and hold: power off. Press and hold for 20 seconds to force power off

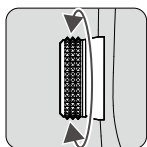

Side Wheel

Press once: switch between focus and zoom

Rotate: control focus or zoom

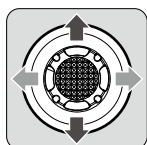

Joystick

Move vertically and horizontally to tilt and pan the mobile phone. The joystick control direction can be set in DJI Mimo. Use the joystick to navigate through settings on the Quick Settings page.

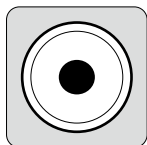

Shutter/Record Button

Press once: take a photo or start or stop recording.

Press and hold: for burst shooting when in photo mode.

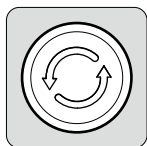

Switch Button

Press once: switch between front and rear cameras.

Press twice: switch between landscape and portrait mode.

Press three times: switch between photo and record mode. The feature can be set to control Quick Settings in DJI Mimo.

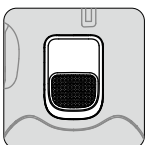

Trigger

Press once to start or stop ActiveTrack 5.0 (requires used with Mimo).

Press twice to recenter the gimbal. When using ActiveTrack 5.0, the gimbal will recenter to the center of the camera view.

Press once, and then press and hold to adjust the follow speed to fast mode, release to exit.

Press and hold to enter lock mode. In lock mode, the gimbal will not follow the handle movements. Release to exit lock mode.

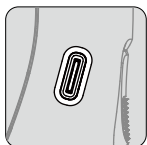

Charging Port (USB-C)

Charge Osmo Mobile 6 by connecting a USB adapter to this port.



1/4"-20 UNC Port

The 1/4"-20 UNC port can be used to attach a tripod.

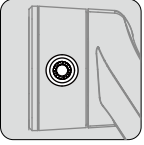

M3×0.5 Screw Hole

Used to mount counterweights. Counterweights should be used if a camera lens or microphone is mounted on the mobile phone. Make sure the total weight of these accessories is less than 290 g.

Combination Operation

Press the switch button, shutter/record button, and trigger simultaneously for more than one second to reset the Bluetooth name and connection and reconnect.

-
-  Osmo Mobile 6 will be powered off automatically if there is no operation for three minutes in standby mode.
-

Operating Mode

Operation modes apply when used in portrait and landscape mode.

Upright Mode

Upright mode can be used without any further user input. In this mode, press the trigger twice quickly to center the mobile phone.

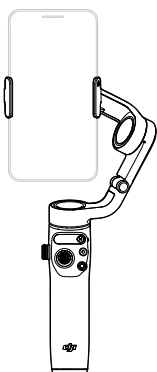

Underslung Mode

Hold Osmo Mobile 6 upside down to enter Underslung mode, in which the mobile phone can easily capture images from a lower position. Press the trigger twice to center the mobile phone.

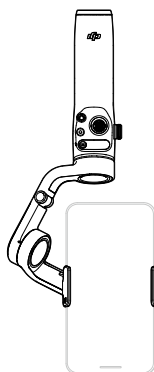

Side Grip Mode

Rotate Osmo Mobile 6 to the right or left by 90° to go from Upright to Side Grip mode. Press the trigger twice to center the mobile phone.

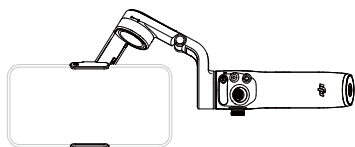

Low Position Mode

Extend the built-in extension rod and adjust the angle to Low Position mode. Use Low Position mode to shoot from a low angle.

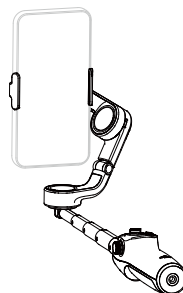

DJI Mimo App

Watch a live HD video feed on your mobile phone screen through the DJI Mimo app. The app also allows you to use ShotGuides, Story mode, Hyperlapse, Timelapse, ActiveTrack 5.0, DynamicZoom, and Pano, or configure camera and gimbal settings in just a few taps.

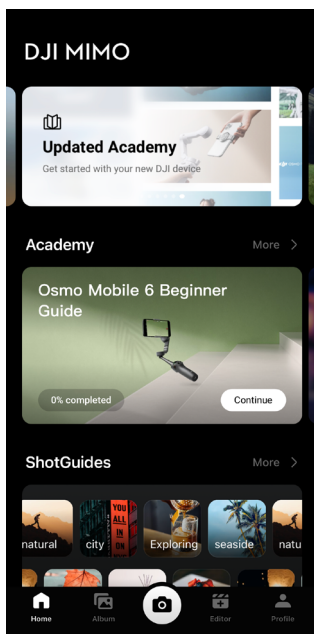

Academy: tap to watch tutorials and view manuals.

Home: tap to return to the home screen.

Album: manage and view footage from the phone or DJI devices.

Device: tap to connect to Osmo Mobile 6. Once connected, DJI Mimo enters camera view.

Editor: tap to edit photos or videos from Osmo Mobile 6 or import and edit from a mobile device.

Profile: tap to view the DJI account, devices and created content, contact Support, or go to DJI Store and DJI Forum.

 The interface and functions of the app may vary as the software version is updated. The actual usage experience is based on the software version used.

Connecting to the DJI Mimo App

1. Power on Osmo Mobile 6.
2. Enable Bluetooth on the mobile phone and connect to the device with an OM6 prefix name in DJI Mimo.
3. Users are required to allow access to certain information when using DJI Mimo for the first time. The exact information will be listed in the prompt. An internet connection is required. Osmo Mobile 6 will be activated after authorization and the app will enter the camera view.

⚠ When connected via Bluetooth, Osmo Mobile 6 is able to control the mobile phone camera without DJI Mimo. Refer to the Mobile Phone Compatibility List for details www.dji.com/osmo-mobile-6.

Camera View

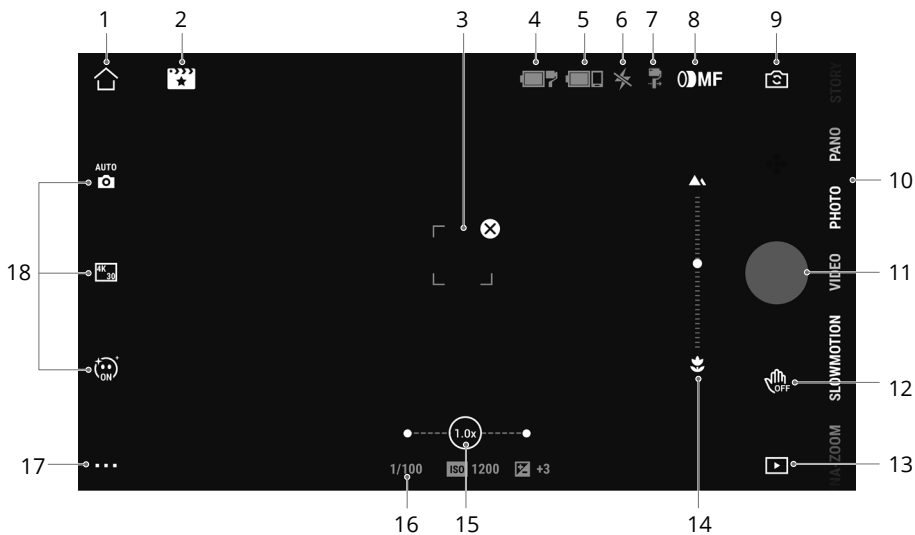

1. Home



🏠: Tap to return to the home screen.

2. ShotGuides

📖: ShotGuides provides step-by-step shooting tutorials according to the scenario, users can edit the video using AI Editor.

3. ActiveTrack Select Box

☞: ActiveTrack 6.0 has been optimized for tracking subjects. The subject will remain in the center of the camera view by default. The camera view can be adjusted manually. There are three ways to use ActiveTrack 6.0:

- a. Drag a box on the screen in the camera view in DJI Mimo. A green box around the subject indicates ActiveTrack 6.0 is successfully enabled. Tap the  icon on the top corner to stop tracking.
- b. Enable Gesture Control , select "Follow and Shoot" in DJI Mimo, and perform a palm or V gesture for one to two seconds when facing the camera. The gimbal will follow the subject closest to the camera. The detection range between the rear camera and the gesture is 0.5 to 4 m. Note that ActiveTrack 6.0 may consume more power and cause the temperature of the mobile phone to increase. Perform a palm or V gesture to stop recording.

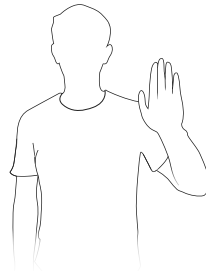
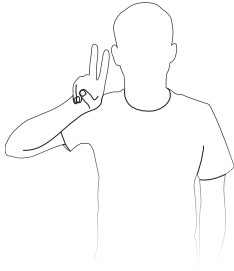

- c. Press the trigger once to start or stop ActiveTrack 6.0. The gimbal will follow the subject in the center of the screen by default. When using ActiveTrack 6.0 move the joystick to adjust the camera view.

4. Gimbal Battery Level

: Displays the current battery level of the gimbal.

5. Mobile Phone Battery Level

: Displays the current battery level of the mobile phone.

6. Flash

: Displays the flash status.

7. Gimbal Mode

: Displays the current gimbal mode: Follow, Tilt Locked, FPV, or SpinShot.

8. Focus/Zoom Mode

MF: Indicates the feature of the side wheel when using focus (MF) or zoom (ZM).

9. Front/Rear camera Switch

: Tap to switch between the front and rear cameras of your mobile phone. Selfie, Follow, and glamour effects are automatically enabled when switching to the front camera. Note: glamour effects are not supported when recording at 4K or 60fps.

10. Shooting Modes

Scroll to select the shooting mode.

Hyperlapse: enable to shoot a Timelapse photo while moving the mobile phone. Tap the shutter button to begin.

Timelapse: there are four types of timelapse (Fixed Angle, L to R, R to L, and Custom Motion). After selecting the timelapse, tap the settings at the top of the screen. For

Fixed Angle, L to R, and R to L, set the interval and duration and start to shoot. For Custom Motion, select up to four positions and the gimbal will move to each position in sequence.

DynamicZoom: choose from Move Out and Move In mode. After selecting a mode, drag a box to select a subject, and tap the shutter button to start shooting.

Slow Motion: tap to shoot video at 4x and 8x slow motion. Check the mobile phone compatibility list for more information.

Video: tap to shoot a normal video.

Photos: tap to take a single shot photo. Press and hold for burst shooting.

Pano: tap to take a 3×3, 240°, or CloneMe panorama photo. The camera will take nine, seven, or three photos separately and generate a pano.

Parents & Kids Mode: Place the gimbal on a flat surface and make sure both the parent and child are in the frame. Tap the Shutter/Record button to start shooting. The gimbal will automatically select the child in the frame to capture precious family moments. When shooting is complete, the video can be automatically edited and generated. Make sure to keep the gimbal stationary during the shooting process. Otherwise, the shooting and movement of the gimbal will be affected.

Story: provides several templates for recording video.

11. Shutter/Record Button

 : Tap to take a photo or to start or stop recording video.

12. Gesture Control Switch

 : Tap to access Gesture Control settings.

13. Playback

 : Tap to preview photos and videos.

14. Focus Distance

 : Click the side wheel to switch to focus mode and display the current focus distance.

15. Zoom

 : Displays the current zoom ratio. Place two fingers on the screen and spread to zoom in, pinch to zoom out, or slide the bar to control zoom.

16. Shooting Parameters

 : Displays the shutter speed, ISO, and EV values (Compatible with most mobile phones).

17. Settings

 : Camera Settings

The settings vary depending on the shooting mode. Note that the flash, white balance, and grid settings are only available when using the rear camera. For iOS devices, Selfie Flip is available when using the front camera in photo and video mode. For Android devices, Selfie Flip is only available in photo mode.

 : Gimbal Settings

Gimbal Mode: choose from Follow, Tilt Locked, FPV, and Spinshot.

Follow Speed: provides Fast, Medium, and Slow follow speed.

Gimbal Auto Calibration: reduces drift caused by nearby magnetic interference or human error. Before calibrating, place Osmo Mobile 6 on a flat surface using a tripod. Do not touch the gimbal during calibration.

Horizontal Gimbal Adjustment: make sure the magnetic phone clamp is level before adjusting the gimbal.

Dial Mode: assign focus, zoom, or disable features for the side wheel.

Press Switch Button 3 Times: features can be set to take photos, record, or enter Quick Settings.

Joystick Speed: tap to set the maximum speed when controlling the joystick. There are Fast, Medium, and Slow options.

Joystick Control Direction: choose from Free and Horiz/Vert. Free enables the gimbal to be controlled in horizontal and vertical direction simultaneously. Horiz/Vert enables the gimbal to be controlled in a horizontal or vertical direction.

Invert Joystick: when enabled, the gimbal movement direction is inverted. Select from Off, Horizontal, Vertical, and All. After enabling Horizontal, the pan-axis movement direction is inverted. After enabling Vertical, the tilt-axis movement direction is inverted.

Invert Dial: when enabled, the dial is inverted from the previous settings. Select from Disable, Focus Direction, Zoom Direction, and All options.

Extended Tilt Mode: when enabled, the gimbal tilt angle becomes larger and tilt control is supported, which is suitable for capturing static scenes such as a desktop.

Sound: the sound of the gimbal can be turned on/off.

: General Settings

Includes information such as Device Management, Device Name, Version Information, and Device Serial Number.

18. Shooting Parameters Settings

Shooting Parameters can be set according to the shooting mode. Tap the icon to access settings.

-
-  • Gesture Control and ActiveTrack 6.0 are not available when the gimbal mode is set to FPV or SpinShot.
 - Selfie and Follow is not available in the following scenarios:
 - a. Gimbal mode is set to FPV or SpinShot.
 - b. Gesture Control is enabled.
 - Shooting parameter settings vary depending on the model of the mobile phone. Refer to the Mobile Phone Compatibility List (www.dji.com/osmo-mobile-6) for more information.
-

Remote Control with Watch

The DJI Mimo app can be used with an Apple Watch, allowing you to view the camera feed, control the gimbal direction and adjust the composition, and enable ActiveTrack remotely on the watch for an effortless shooting experience.

Device Connection

1. Enable Bluetooth on both the watch and the phone. Make sure the watch and the phone are paired.
2. After pairing, make sure the latest version of the DJI Mimo app is installed and updated on the watch.
3. Power on Osmo Mobile 6 and make sure it is fully charged.
4. Run the DJI Mimo app on the phone, and connect Osmo Mobile 6 with the phone following the prompts in the app.
5. Once connected, you will be directed to the camera view on the phone. Run DJI Mimo on the watch and enter the camera view to start shooting remotely.

-
- ⚠ • During connection, DO NOT close the app. Make sure the distance between the devices is within the effective Bluetooth range.
- Visit <https://www.dji.com/osmo-mobile-6/faq> for more information on the devices supported by the DJI Mimo app.
-

Remote Control

Camera View



1. Swipe right to switch between video and photo mode.
2. Tap the shutter/record button to take photos or start recording. There is a default 3-second countdown when taking photos on the watch, and the countdown duration can be modified in the DJI Mimo app on your phone.

Gimbal Control

Tap  on the left side of the camera view to enter the gimbal control view and adjust the composition on the watch.



1. Joystick: drag the joystick on the screen to control the gimbal direction. Drag or tap the joystick to hide other icons.
2. Portrait/Landscape Switch: tap to switch between Landscape and Portrait modes.
3. Recenter Button: tap to recenter the gimbal.
4. Close Button: tap to exit the gimbal control view.

ActiveTrack

Tap  on the right side of the camera view to enable or disable ActiveTrack on the watch. When enabled, the gimbal will recognize and follow the subject in the center of the screen.

Preview

When shooting is complete, the photo or the first frame of the video will be displayed at the bottom left of the screen on the watch. You can playback and edit the footage in the DJI Mimo app on the phone.

Firmware Update

Use DJI Mimo to update the Osmo Mobile 6 firmware. It takes approximately three minutes to complete an update.

How to Update

Before starting an update, make sure that the battery level indicator shows green or yellow. Connect Osmo Mobile 6 to your mobile device and launch DJI Mimo. You will be prompted if a new firmware update is available. To start updating, connect the mobile device to the internet and follow the on-screen instructions.

Do not exit DJI Mimo while updating the firmware. Pay attention to on-screen prompts. The system status indicator will blink green and red alternatively and become solid green once the firmware update has completed successfully.

If an update is unsuccessful, restart DJI Mimo, reconnect the Bluetooth, and retry.

Storage

Osmo Mobile 6 is designed to be folded for easier storage and transportation. Make sure to fully retract the built-in extension rod and fold the Osmo Mobile 6 after powering off. Rotate the pan and tilt axis as shown and fold the gimbal. The mark on the axis arm should slot into the hole on the handle. Rotate the pan axis as shown to lock in place.

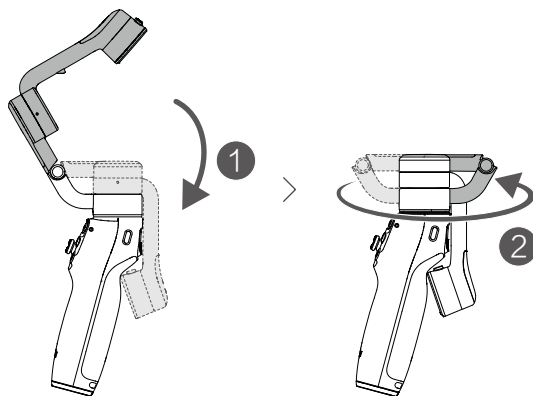

Specifications

General	
Gimbal Dimensions	Unfolded: 276×111.5×99 mm (L×W×H) Folded: 189×84.5×44 mm (L×W×H)
Weight	Gimbal: Approx. 309 g Magnetic Phone Clamp: Approx. 31 g
Max Length of Built-in Extension Rod	215 mm
Compatible Phone Weight	170-290 g
Compatible Phone Thickness	6.9-10 mm
Compatible Phone Width	67-84 mm
Battery	
Type	Li-Po 2S
Chemical System	LiCoO2
Capacity	1000 mAh
Energy	7.74 Wh
Voltage	6-8.8 V
Charging Temperature	5° to 40° C (41° to 104° F)
Operating Temperature	0° to 40° C (32° to 104° F)
Operating Time	Approx. 6 hours and 24 minutes (measured under ideal conditions with the gimbal fully balanced)
Charging Time	Approx. 1 hour 24 minutes (measured with a 10W USB-C charger)
Gimbal Charging Port	USB-C
Power Output Port	N/A
Bottom Port	1/4"-20 Screw Hole
Gimbal	
Power Consumption	1.1 W (Approximate, measured under ideal conditions)
Controllable Range	Pan: -95° to 95° Roll: -100° to 175° Tilt: -25° to 40°
Mechanical Range	Pan: -161.64° to 173.79° Roll: -120.30° to 211.97° Tilt: -101.64° to 78.55°
Max Control Speed	120°/s
Wireless Mode	
Model	Bluetooth 5.1
Other	
App	DJI Mimo
Grip Tripod	
Dimensions	Length: 138 mm Diameter: 32 mm
Weight	Approx. 72 g

WE ARE HERE FOR YOU



Contact

DJI SUPPORT

This content is subject to change.



<https://www.dji.com/osmo-mobile-6/downloads>

If you have any questions about this document, please contact DJI by sending a message to DocSupport@dji.com.

DJI and OSMO are trademarks of DJI.
Copyright © 2024 DJI All Rights Reserved.