

**Canon**

# EOS R100



Advanced User Guide

**E**

# Contents

---

Introduction. . . . .	8
Package Contents. . . . .	9
Supplemental Information. . . . .	10
Compatible Accessories. . . . .	11
Instruction Manuals. . . . .	12
Quick Start Guide. . . . .	13
About This Guide. . . . .	16
Compatible Cards. . . . .	18
Safety Instructions. . . . .	19
Handling Precautions. . . . .	22
Part Names. . . . .	26
Software/Apps. . . . .	34
Preparation and Basic Operations. . . . .	38
Charging the Battery. . . . .	39
Inserting/Removing the Battery and Card. . . . .	42
Turning on the Power. . . . .	48
Attaching and Detaching RF/RF-S Lenses. . . . .	51
Attaching and Detaching EF/EF-S Lenses. . . . .	56
Using the Viewfinder. . . . .	60
Basic Operations. . . . .	61
Setting the Screen Display Level. . . . .	68
Menu Operations and Settings. . . . .	75
Quick Control. . . . .	82
Basic Zone. . . . .	85
Scene Intelligent Auto. . . . .	86
Hybrid Auto. . . . .	95
Special Scene Mode. . . . .	99
Portrait Mode. . . . .	102
Landscape Mode. . . . .	103
Sports Mode. . . . .	104

Panning Mode	105
Close-up Mode	107
Food Mode	108
Night Portrait Mode	109
Handheld Night Scene Mode	111
HDR Backlight Control Mode	113
Silent Shutter Mode	114
Creative Filters Mode	115
Creative Zone	122
P: Program AE	123
Tv: Shutter-Priority AE	125
Av: Aperture-Priority AE	128
M: Manual Exposure	132
Long (Bulb) Exposures	135
AF, Drive, and Exposure Settings	137
AF Operation	138
AF Method	144
Manual Focus	157
Drive Mode	161
Using the Self-Timer	162
Remote Control Shooting	164
Metering Mode	166
Exposure Compensation	168
Exposure Lock (AE Lock)	170
Flash Photography	172
Shooting with the Built-in Flash	173
Flash Function Settings	177
Shooting with Speedlites	194
Shooting and Recording	196
Still Photo Shooting	197
Tab Menu: Still Photo Shooting	199
Image Quality	206

Still Image Aspect Ratio	209
Exposure Compensation/AEB Settings	211
ISO Speed Settings for Still Photos	213
Auto Lighting Optimizer	216
Highlight Tone Priority	218
White Balance Settings	219
White Balance Correction	227
Color Space	230
Picture Style Selection	231
Picture Style Customization	235
Picture Style Registration	240
Lens Aberration Correction	243
Noise Reduction Features	250
Appending Dust Delete Data	254
Continuous AF	258
Focus Mode	259
AF-Assist Beam Firing	260
Lens Electronic MF	261
Focus/Control Ring	262
Image Stabilizer (IS Mode)	263
Review Duration	265
Metering Timer	266
Exposure Simulation	267
Shooting Information Display	268
Viewfinder Display Format	277
Display Performance	278
General Still Photo Shooting Precautions	279
Movie Recording	282
Tab Menus: Movie Recording	283
Movie Recording	287
Movie Recording Quality	295
Sound Recording	302
Time-Lapse Movies	305

Movie Servo AF. . . . .	316
Digital Zoom. . . . .	319
Shutter Button Function for Movies. . . . .	321
Movie Self-Timer. . . . .	323
Movie Digital IS. . . . .	324
Miniature Effect Movies. . . . .	326
Other Menu Functions. . . . .	329
General Movie Recording Precautions. . . . .	335
<b>Playback. . . . .</b>	<b>338</b>
Tab Menus: Playback. . . . .	339
Image Playback. . . . .	342
Index Display (Multiple-Image Display). . . . .	345
Magnified Image Display. . . . .	348
Movie Playback. . . . .	350
Editing a Movie's First and Last Scenes. . . . .	354
Frame Extraction from 4K Movies or 4K Time-Lapse Movies. . . . .	357
Digest Movie Editing. . . . .	360
Playback on a TV Set. . . . .	363
Protecting Images. . . . .	365
Erasing Images. . . . .	369
Rotating Still Photos. . . . .	376
Changing Movie Orientation Information. . . . .	378
Rating Images. . . . .	380
Print Ordering (DPOF). . . . .	386
Photobook Set-up. . . . .	391
Creative Assist. . . . .	396
Creative Filters. . . . .	399
Red-Eye Correction. . . . .	403
Resizing. . . . .	405
Cropping. . . . .	407
Slide Show. . . . .	410
Setting Image Search Conditions. . . . .	415
Resuming from Previous Playback. . . . .	418

Browsing Images with the Dial. . . . .	419
Playback Information Display. . . . .	421
AF Point Display. . . . .	424
HDMI HDR Output. . . . .	425
Wireless Features. . . . .	426
Tab Menus: Wireless Settings. . . . .	427
Wi-Fi/Bluetooth Connection. . . . .	428
Connecting to a Smartphone. . . . .	430
Connecting to a Computer via Wi-Fi. . . . .	470
Connecting to a Printer via Wi-Fi. . . . .	477
Sending Images to a Web Service. . . . .	491
Wi-Fi Connection via Access Points. . . . .	507
Connecting to a Wireless Remote Control. . . . .	515
Reconnecting via Wi-Fi. . . . .	519
Registering Multiple Connection Settings. . . . .	521
Airplane Mode. . . . .	522
Wi-Fi Settings. . . . .	523
Bluetooth Settings. . . . .	524
Nickname. . . . .	525
GPS Settings. . . . .	526
Changing or Deleting Connection Settings. . . . .	530
Resetting Communication Settings. . . . .	532
View Info Screen. . . . .	533
Virtual Keyboard Operations. . . . .	534
Responding to Error Messages. . . . .	535
Wireless Communication Function Precautions. . . . .	545
Security. . . . .	547
Checking Network Settings. . . . .	548
Wireless Communication Status. . . . .	549
Set-up. . . . .	551
Tab Menus: Set-up. . . . .	552
Folder Settings. . . . .	555

File Numbering. . . . .	558
Card Formatting. . . . .	563
Auto Rotate. . . . .	566
Adding Orientation Information to Movies. . . . .	568
Date/Time/Zone. . . . .	569
Language. . . . .	574
Video System. . . . .	575
Beeeps. . . . .	576
Power Saving. . . . .	577
Eco Mode. . . . .	578
Display Settings. . . . .	579
Screen Brightness. . . . .	581
Viewfinder Brightness. . . . .	582
HDMI Resolution. . . . .	583
Resetting the Camera. . . . .	584
Custom Functions (C.Fn). . . . .	585
Copyright Information. . . . .	594
Other Information. . . . .	597
<b>My Menu. . . . .</b>	<b>598</b>
Tab Menus: My Menu. . . . .	599
Registering My Menu. . . . .	600
<b>Reference. . . . .</b>	<b>606</b>
Importing Images to a Computer. . . . .	607
Troubleshooting Guide. . . . .	610
Error Codes. . . . .	625
ISO Speed in Movie Recording. . . . .	626
Information Display. . . . .	627
Specifications. . . . .	641
<b>Trademarks and Licensing. . . . .</b>	<b>661</b>

# Introduction

---

## Before starting to shoot, be sure to read the following

To avoid shooting problems and accidents, first read the [Safety Instructions](#) and [Handling Precautions](#). Also read this Advanced User Guide carefully to ensure that you use the camera correctly.

## Take some test shots, and understand about product liability

After shooting, play images back and check whether they have been properly recorded. If the camera or memory card is faulty and images cannot be recorded or transferred to a computer, Canon cannot be held liable for any loss or inconvenience caused.

## Copyrights

Copyright laws in some countries prohibit the unauthorized use of images recorded with the camera (or music/images with music transferred to the memory card) for purposes other than personal enjoyment. Also be aware that certain public performances, exhibitions, etc. may prohibit photography even for private enjoyment.

- [Package Contents](#)
- [Supplemental Information](#)
- [Compatible Accessories](#)
- [Instruction Manuals](#)
- [Quick Start Guide](#)
- [About This Guide](#)
- [Compatible Cards](#)
- [Safety Instructions](#)
- [Handling Precautions](#)
- [Part Names](#)
- [Software/Apps](#)



## Package Contents

---

Before use, make sure the following items are included in the package. If anything is missing, contact your dealer.

---

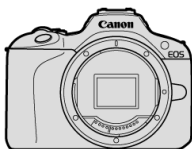

### Camera

(with body cap (Camera Cover R-F-5))



### Battery Pack LP-E17

(with protective cover)



### Battery Charger LC-E17



### Strap

- The camera does not come with a memory card (🔗), interface cable, or HDMI cable.
- If you purchased a Lens Kit, check that the lenses are included.
- Be careful not to lose any of these items.
- No software CD-ROM is included. Software (🔗) can be downloaded from the Canon website.

### ⚠ Caution

- When you need Lens Instruction Manuals, download them from the Canon website (🔗).  
Lens Instruction Manuals (PDF files) are for lenses sold separately, and when a lens kit is purchased, some accessories included with the lens may not match those listed in the Lens Instruction Manual.

## Supplemental Information

---

Refer to the following website for information on lenses compatible with camera features, and for supplemental information about the camera.

- <https://cam.start.canon/H001/>



## Compatible Accessories

---

Check the following website for details on compatible accessories.

- <https://cam.start.canon/H002/>



## Instruction Manuals

---

- **Instruction Manual (included with the camera)**

Provides basic camera instructions.

- **Advanced User Guide**

Complete instructions are provided in this Advanced User Guide.

For the latest Advanced User Guide, refer to the following website.

<https://cam.start.canon/C015/>



- **Lens/Software Instruction Manual**

Download from the following website and refer to the supplemental information.

<https://cam.start.canon/>



### Note

- Select [: **Manual/software URL**] to display the QR code on the camera screen.

### 1. Insert the battery (🔒).

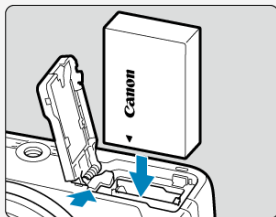
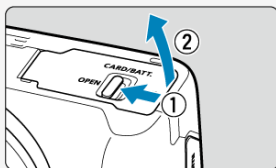

- Upon purchase, charge the battery to start using (🔒).

### 2. Insert the card (🔒).

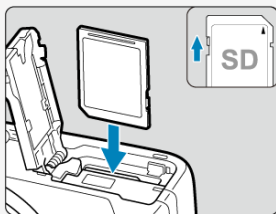

- Insert the card with the label facing the front of the camera until it clicks into place.

### 3. Attach the lens (🔗).

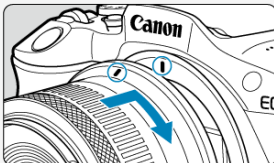

- Align the red mount index on the lens with the red mount index on the camera to attach the lens.

### 4. Set the power switch to <ON>, then set the Mode dial to <A+> (🔗, 🔗).

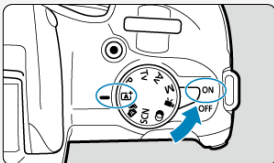

- All the necessary camera settings is set automatically.
- If the [Date/Time/Zone] setting screen is displayed, see [Date/Time/Zone](#).

### 5. Focus on the subject (🔗).



- A tracking frame [ ] for AF appears over any face detected.
- Press the shutter button halfway, and the camera will focus on the subject.
- If <🔦> blinks on the screen, manually raise the built-in flash.

## 6. Take the picture (📷).

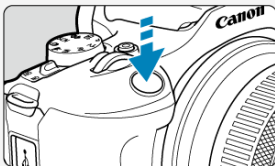

- Press the shutter button completely to take the picture.

## 7. Review the picture.



- The image just captured will be displayed for approx. 2 sec. on the screen.
- To display the image again, press the <▶> button (📷).

# About This Guide







---

 [Icons in This Guide](#)







 [Basic Assumptions for Operational Instructions and Sample Photos](#)

## Icons in This Guide

---

	Indicates the dial.
	Indicates the direction to press the cross keys (<  >).
	Indicates the lens control ring.
	Indicates the Quick Control/Set button.
	Indicates the duration (in * seconds) of the operation for the button you pressed, as timed after you release the button.

- In addition to the above, the icons and symbols used on the camera's buttons and displayed on the screen are also used in this guide when discussing relevant operations and functionality.

	☆ to the right of titles indicates functions only available in Creative Zone modes (<P>, <Tv>, <Av>, or <M>).
	Links to pages with related topics.
	Warning to prevent shooting problems.
	Supplemental information.
	Tips or advice for better shooting.
	Troubleshooting advice.



## Basic Assumptions for Operational Instructions and Sample Photos

---

- Before following any instructions, make sure the power switch is set to < ON > (🔌).
- It is assumed that all the menu settings and Custom Functions are set to their defaults.
- Illustrations in this guide show the camera with the RF-S18-45mm F4.5-6.3 IS STM lens attached as an example.
- The sample photos displayed on the camera and used in this guide are for instructional purposes only.
- In references to using EF or EF-S lenses, it is assumed that a mount adapter is used.

## Compatible Cards

---

The following cards can be used with the camera regardless of capacity. **If the card is new or was previously formatted (initialized) by another camera or computer, format the card with this camera** (🔗).

- **SD/SDHC/SDXC memory cards**

UHS-I cards supported.

### Cards That Can Record Movies

---

When recording movies, use a card with ample performance (fast enough writing and reading speeds) for the movie recording size (🔗).



In this guide, "card" refers to SD memory cards, SDHC memory cards, and SDXC memory cards.

**\*A card is not included.** Please purchase it separately.

## Safety Instructions

---

Be sure to read these instructions in order to operate the product safely.  
Follow these instructions to prevent injury or harm to the operator of the product or others.

 **WARNING:** Denotes the risk of serious injury or death.

- Keep the product out of the reach of young children.

Keep batteries out of the reach of children.

A strap wrapped around a person's neck may result in strangulation.

The parts or provided items of cameras or accessories are dangerous if swallowed. If swallowed, seek immediate medical assistance.

The battery is dangerous if swallowed. If swallowed, seek immediate medical assistance.

- **PRODUCT CONTAINS BUTTON/COIN CELL BATTERY**

Button/coin cell batteries are hazardous and must be kept out of reach of children at all times, whether new or used.

These batteries can cause severe or fatal injuries in 2 hours or less if swallowed or placed inside any part of the body.

If it is suspected a button/coin cell battery has been swallowed or placed inside any part of the body, seek medical attention immediately.

- Use only power sources specified in this instruction manual for use with the product.
- Do not disassemble or modify the product.
- Do not expose the product to strong shocks or vibration.
- Do not touch any exposed internal parts.
- Stop using the product in any case of unusual circumstances such as the presence of smoke or a strange smell.
- Do not use organic solvents such as alcohol, benzine or paint thinner to clean the product.
- Do not get the product wet. Do not insert foreign objects or liquids into the product.
- Do not use the product where flammable gases may be present.

This may cause electric shock, explosion or fire.

- Do not leave a lens or a camera/camcorder with a lens attached, exposed without the lens cap attached.

The lens may concentrate the light and cause fire.

- Do not touch the product connected to a power outlet during lightning storms.

This may cause electric shock.

- Observe the following instructions when using commercially available batteries or provided battery packs.
  - Use batteries/battery packs only with their specified product.
  - Do not heat batteries/battery packs or expose them to fire.
  - Do not charge batteries/battery packs using non-authorized battery chargers.
  - Do not expose the terminals to dirt or let them come into contact with metallic pins or other metal objects.
  - Do not use leaking batteries/battery packs.
  - When disposing of batteries/battery packs, insulate the terminals with tape or other means.

This may cause electric shock, explosion or fire.

If a battery/battery pack leaks and the material contacts your skin or clothing, flush the exposed area thoroughly with running water. In case of eye contact, flush thoroughly with copious amounts of clean running water and seek immediate medical assistance.

- Observe the following instructions when using a battery charger or AC adapter.
  - Periodically remove any dust buildup from the power plug and power outlet using a dry cloth.
  - Do not plug in or unplug the product with wet hands.
  - Do not use the product if the power plug is not fully inserted into the power outlet.
  - Do not expose the power plug and terminals to dirt or let them come into contact with metallic pins or other metal objects.
  - Do not touch the battery charger or AC adapter connected to a power outlet during lightning storms.
- Do not place heavy objects on the power cord. Do not damage, break or modify the power cord.
- Do not wrap the product in cloth or other materials when in use or shortly after use when the product is still warm in temperature.
- Do not unplug the product by pulling the power cord.
- Do not leave the product connected to a power source for long periods of time.
- Do not charge batteries/battery packs at temperatures outside the range of 5 - 40 °C (41 - 104 °F).

This may cause electric shock, explosion or fire.

- Do not allow the product to maintain contact with the same area of skin for extended periods of time during use.

This may result in low-temperature contact burns, including skin redness and blistering, even if the product does not feel hot. The use of a tripod or similar equipment is recommended when using the product in hot places and for people with circulation problems or less sensitive skin.

- Follow any indications to turn off the product in places where its use is forbidden.

Not doing so may cause other equipment to malfunction due to the effect of electromagnetic waves and even result in accidents.

- Do not leave batteries near pets.

Pets biting a battery could cause leakage, overheating, or explosion, resulting in product damage or fire.



## CAUTION:

Follow the cautions below. Otherwise physical injury or property damage may result.

- Do not fire the flash near the eyes.

It may hurt the eyes.

- Do not look at the screen or through the viewfinder for prolonged periods of time.

This may induce symptoms similar to motion sickness. In such a case, stop using the product immediately and rest for a while before resuming use.

- Flash emits high temperatures when fired. Keep fingers, any other part of your body, and objects away from the flash unit while taking pictures.

This may cause burns or malfunction of the flash.

- Do not leave the product in places exposed to extremely high or low temperatures.

The product may become extremely hot/cold and cause burns or injury when touched.

- Strap is intended for use on the body only. Hanging the strap with any product attached on a hook or other object may damage the product. Also, do not shake the product or expose the product to strong impacts.

- Do not apply strong pressure on the lens or allow an object to hit it.

This may cause injury or damage to the product.

- Only mount the product on a tripod that is sufficiently sturdy.

- Do not carry the product when it is mounted on a tripod.

This may cause injury or may result in an accident.

- Do not touch any parts inside the product.

This may cause injury.

- If any abnormal skin reaction or irritation occurs during or following the use of this product, refrain from further use and get medical advice/attention.

# Handling Precautions

---

## Camera care

- This camera is a precision instrument. Do not drop it or subject it to physical shock.
- The camera is not waterproof and cannot be used underwater. If the camera gets wet, contact a Canon Service Center immediately. Wipe off any water droplets with a dry and clean cloth. If the camera has been exposed to salty air, wipe it with a clean, well-wrung wet cloth.
- Never leave the camera near anything having a strong magnetic field such as a magnet or electric motor. Also, avoid using or leaving the camera near anything emitting strong radio waves, such as a large antenna. Strong magnetic fields can cause camera malfunction or destroy image data.
- Do not leave the camera in excessive heat, such as in a car in direct sunlight. High temperatures can cause the camera to malfunction.
- The camera contains precision electronic circuitry. Never attempt to disassemble the camera yourself.
- Do not block shutter curtain operation with your finger or other objects. Doing so may cause a malfunction.
- Only use a commercially available blower to blow away dust on the lens, viewfinder, or other parts. Do not use cleaners that contain organic solvents to clean the camera body or lens. For stubborn dirt, take the camera to the nearest Canon Service Center.
- Do not touch the camera's electrical contacts with your fingers. This is to prevent the contacts from corroding. Corroded contacts can cause camera malfunction.
- If the camera is suddenly brought in from the cold into a warm room, condensation may form on the camera and internal parts. To prevent condensation, first put the camera in a sealed plastic bag and let it adjust to the warmer temperature before taking it out of the bag.
- If condensation forms on the camera, to avoid damage, do not use the camera or remove the lens, card, or battery. Turn the camera off and wait until the moisture has fully evaporated before resuming use. Even after the camera is completely dry, if it is still internally cold, do not remove the lens, card, or battery until the camera has adjusted to the ambient temperature.
- If the camera will not be used for an extended period, remove the battery and store the camera in a cool, dry, well-ventilated location. Even while the camera is in storage, press the shutter button a few times once in a while to check that the camera is still working.
- Avoid storing the camera where there are chemicals that result in rust and corrosion such as in a chemical lab.
- If the camera has not been used for an extended period, test all its functions before using it. If you have not used the camera for some time or if there is an important shoot such as a foreign trip coming up, have the camera checked by your nearest Canon Service Center or check the camera yourself and make sure it is working properly.
- The camera may become hot after repeated continuous shooting or still photo/movie shooting over an extended period. This is not a malfunction.
- If there is a bright light source inside or outside the image area, ghosting may occur.
- When shooting with backlighting, keep the sun sufficiently away from the angle of view. Always keep intense light sources such as the sun, lasers, and other intense artificial light sources out of the image area and not near it. Concentrated intense light may cause smoke or damage the image sensor or other internal components.

- Attach the lens cap to prevent direct sunlight and other light from entering the lens when you are not shooting.

## Screen and viewfinder

The following does not affect images captured by the camera.

- Although the screen and viewfinder are manufactured with very high precision technology with over 99.99% effective pixels, 0.01% or fewer of the pixels may be dead, and there may also be spots of black, red, or other colors. This is not a malfunction.
- If the screen is left on for a prolonged period, screen burn-in may occur where you see remnants of what was displayed. However, this is only temporary and will disappear when the camera is left unused for a few days.
- The screen display may seem slightly slow in low temperatures or may look black in high temperatures, but it will return to normal at room temperature.

## Cards

To protect the card and its recorded data, note the following:

- Do not drop, bend, or wet the card. Do not subject it to excessive force, physical shock, or vibration.
- Do not touch the card's electronic contacts with your fingers or anything metallic.
- Do not affix any stickers, etc. on the card.
- Do not store or use the card near anything that has a strong magnetic field, such as a television, speakers, or magnets. Also avoid places prone to having static electricity.
- Do not leave the card in direct sunlight or near a heat source.
- Store the card in a case.
- Do not store the card in hot, dusty, or humid locations.
- Cards may become hot after long sessions of repeated continuous shooting or still photo shooting/movie recording. This is not a malfunction.

## Lens

- After detaching the lens from the camera, put down the lens with the rear end up and attach the rear lens cap to avoid scratching the lens surface and electrical contacts (1).

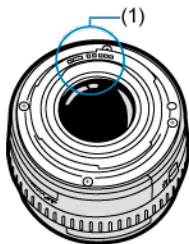





## Smudges on the image sensor

- You can use a commercially available blower to remove dust or debris on the image sensor that appears in images.
- Besides dust entering the camera from outside, in rare cases, lubricant from the camera's internal parts may adhere to the front of the sensor.
- If smudges are visible on images, have the sensor cleaned by a nearest Canon Service Center.



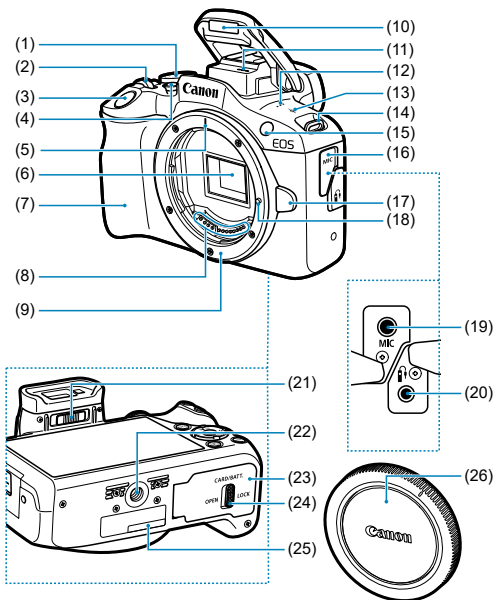





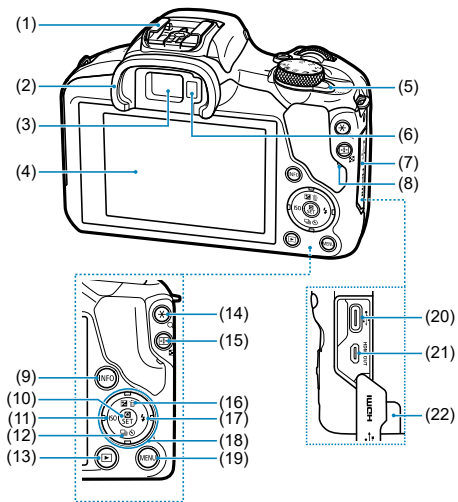

## Part Names

### [Attaching the Strap](#)



- 
- (1) Mode dial
  - (2) <  > Dial
  - (3) Shutter button
  - (4) Movie shooting button
  - (5) RF lens mount index
  - (6) Image sensor
  - (7) Grip
  - (8) Contacts
  - (9) Lens mount
  - (10) Built-in flash
  - (11) Microphone (monaural)
  - (12) Speaker
  - (13) <  > Focal plane mark
  - (14) Strap mount
  - (15) AF-assist beam/red-eye reduction/self-timer/remote control lamp
  - (16) Terminal cover
  - (17) Lens release button
  - (18) Lens lock pin
  - (19) < **MIC** > External microphone IN terminal
  - (20) Remote control terminal
  - (21) Dioptic adjustment slider
  - (22) Tripod socket
  - (23) Card/battery compartment cover
  - (24) Card/battery compartment cover lock
  - (25) Serial number (body number)
  - (26) Body cap
-



(1)	Hot shoe
(2)	Eyecup
(3)	Viewfinder eyepiece
(4)	Screen
(5)	< ON / OFF > Power switch
(6)	Viewfinder sensor
(7)	Terminal cover
(8)	Access lamp
(9)	< INFO > Info button
(10)	<  > Quick Control/Set button
(11)	<  / ISO > Left/ISO speed setting button
(12)	<  > Down/self-timer/drive mode selection button
(13)	<  > Playback button
(14)	<  / Q > AE lock/FE lock/magnify button
(15)	<  > AF point selection/index/reduce button
(16)	<  > Up/exposure compensation/erase button
(17)	<  /  > Right/Flash button
(18)	<  > Cross keys
(19)	< MENU > Menu button
(20)	<  > Digital terminal
(21)	< HDMI OUT > HDMI micro OUT terminal
(22)	DC cord hole

## Mode dial

Features on the Mode dial are grouped into Basic Zone, Creative Zone, and movie recording modes.

### (1) Basic Zone



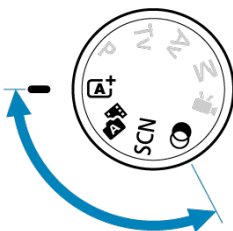







All you do is press the shutter button. The camera sets everything to suit the subject or scene for shooting.













**A+**: Scene Intelligent Auto (🔗)

**A**: Hybrid Auto (🔗)

**SCN**: Special scene (🔗)

	<a href="#">Portrait</a>		<a href="#">Food</a>
	<a href="#">Landscape</a>		<a href="#">Night Portrait</a>
	<a href="#">Sports</a>		<a href="#">Handheld Night Scene</a>
	<a href="#">Panning</a>		<a href="#">HDR  HDR Backlight Control</a>
	<a href="#">Close-up</a>		<a href="#">Silent Mode</a>

**Creative filters** (🔗)

	<a href="#">Grainy B/W</a>		<a href="#">Miniature effect</a>
	<a href="#">Soft focus</a>		<a href="#">HDR  HDR art standard</a>
	<a href="#">Fish-eye effect</a>		<a href="#">HDR  HDR art vivid</a>
	<a href="#">Water painting effect</a>		<a href="#">HDR  HDR art bold</a>
	<a href="#">Toy camera effect</a>		<a href="#">HDR  HDR art embossed</a>

## (2) Creative Zone

These modes give you more control for shooting various subjects as desired.

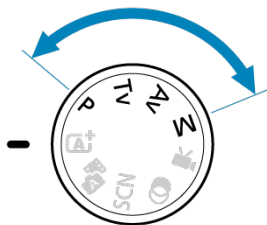

P	<a href="#">Program AE</a>
Tv	<a href="#">Shutter-priority AE</a>
Av	<a href="#">Aperture-priority AE</a>
M	<a href="#">Manual exposure</a>

## (3) Movie recording

For a variety of movie recording (📹).

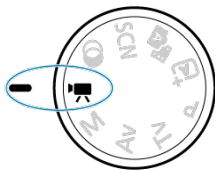

## Battery Charger LC-E17

Charger for Battery Pack LP-E17 (🔗).

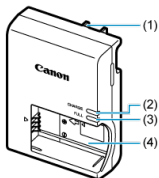

(1) Power plug

---

(2) Charge lamp

---

(3) Full-charge lamp

---

(4) Battery slots

---



## Attaching the Strap

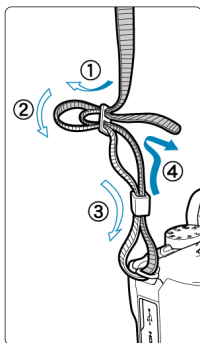

Pass the end of the strap through the strap mount from the bottom, then pass it through the strap buckle as shown. Pull the strap to take up any slack and make sure the strap will not loosen from the buckle.

# Software/Apps

---

[!\[\]\(529949c2c3dadbaa4e538e8c643454bc\_img.jpg\) Software/App Overview](#)

[!\[\]\(3dfb8d66e81160ad61421a3452093d1b\_img.jpg\) Installing Computer Software](#)

[!\[\]\(99f58673407353e96a019fbca558fd72\_img.jpg\) Installing Smartphone Apps](#)

[!\[\]\(0f848bbd71cef6b345273b16f905912a\_img.jpg\) Software Instruction Manuals](#)

## Software/App Overview

---

This section summarizes software used with EOS cameras. Note that installing the software requires an internet connection. The software cannot be installed in environments without an internet connection.

### Computer software

- **EOS Utility**

Enables you to transfer captured images from the camera to a connected computer, set various camera settings from the computer, and shoot remotely from the computer.

- **Digital Photo Professional**

Software recommended for users who shoot RAW images. Enables image viewing, editing, printing, and more.

- **Picture Style Editor**

Enables you to edit existing Picture Styles or create and save original Picture Style files. This software is for users who are familiar with image processing.

### Smartphone apps

- **Camera Connect**

Enables you to transfer captured images from the camera to a smartphone over a wired or wireless connection, set various camera settings from the smartphone, and shoot remotely from the smartphone.

- **Digital Photo Professional Express**

App for RAW image processing and image editing on a smartphone or tablet. Requires a paid subscription.

## Installing Computer Software

---

Always install the latest version of the software. In this case, previous versions are overwritten.

### Caution

- Do not install software while the camera is connected to the computer. The software will not be installed correctly.
- Installation is not possible without an internet connection.
- Older versions of the software do not support RAW image processing or correct display for images from this camera.

### 1. Download the software.

- Connect to the internet from a computer and access the following Canon website.  
<https://cam.start.canon/>

Depending on the software, you may need to enter the camera's serial number. The serial number is on the bottom of the camera.

### 2. Extract the installer on the computer.

#### For Windows

- Click the displayed installer file to start the installer.

#### For macOS

- Double-click the dmg file to open the installation window.
- Double-click the icon in this window to start the installer.

### 3. Follow the on-screen instructions to install the software.

## Installing Smartphone Apps

---

- Always install the latest version.
- Apps can be installed from Google Play or App Store.
- You can also access Google Play and App Store from the following Canon website.  
<https://cam.start.canon/>



Check the following website for software instruction manuals.

- <https://cam.start.canon/>



# Preparation and Basic Operations

---

This chapter describes preparatory steps before you start shooting and the basic camera operations.

- [Charging the Battery](#)
- [Inserting/Removing the Battery and Card](#)
- [Turning on the Power](#)
- [Attaching and Detaching RF/RF-S Lenses](#)
- [Attaching and Detaching EF/EF-S Lenses](#)
- [Using the Viewfinder](#)
- [Basic Operations](#)
- [Setting the Screen Display Level](#)
- [Menu Operations and Settings](#)
- [Quick Control](#)

## Charging the Battery

---

1. Detach the protective cover provided with the battery.

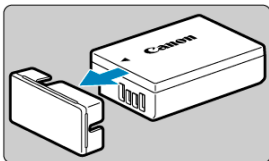

2. Fully insert the battery into the charger.

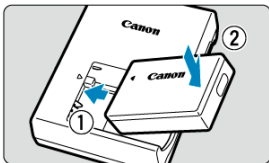

- Do the opposite to remove the battery.

### 3. Charge the battery.

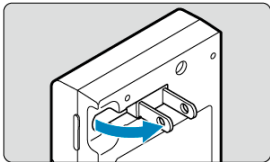

- Flip out the charger prongs as shown and plug the charger into a power outlet.

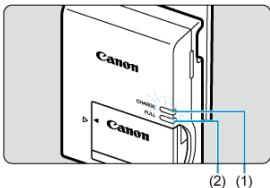

- Charging starts automatically and the charge lamp (1) lights up in orange.
- When the battery is fully charged, the full-charge lamp (2) will light up in green.
- **Charging a depleted battery takes approx. 2 hr. at room temperature (23°C/73°F).**  
The time required to charge the battery will vary greatly depending on the ambient temperature and the battery's remaining capacity.
- For safety, charging in low temperatures (5–10°C/41–50°F) takes longer (up to approx. 4 hr.).

- **Upon purchase, the battery is not fully charged.**

Charge the battery before use.

- **Charge the battery on the day before or on the day it is to be used.**

Charged batteries gradually lose their charge, even when they are not used.

- **After charging the battery, remove it and disconnect the charger from the power outlet.**

- **When not using the camera, remove the battery.**

If the battery is left in the camera for a prolonged period, a small amount of power current will keep being released, resulting in excess discharge and shorter battery life. Store the battery with the protective cover attached. Storing the battery when it is fully charged may lower the battery performance.



- **The battery charger can also be used in foreign countries.**

The battery charger is compatible with a 100 V AC to 240 V AC 50/60 Hz power source. If necessary, attach a commercially available plug adapter for the respective country or region. Do not attach any portable voltage transformer to the battery charger. Doing so may damage the battery charger.

- **If the battery becomes exhausted quickly even after having been fully charged, the battery has reached the end of its service life.**

Purchase a new battery.



#### **Caution**

- After disconnecting the charger's power plug, do not touch the prongs for approx. 5 sec.
- The provided charger cannot charge any battery other than Battery Pack LP-E17.

## Inserting/Removing the Battery and Card

---

[Insertion](#)

[Formatting the Card](#)

[Removal](#)

Insert a fully charged Battery Pack LP-E17 and card in the camera. The captured images are recorded onto the card.

---

### Insertion

---

1. Slide the card/battery compartment cover lock and open the cover.

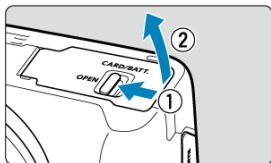

2. Insert the battery.

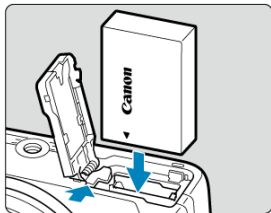

- Insert the end with the electrical contacts.
- Insert the battery until it locks in place.

### 3. Insert the card.

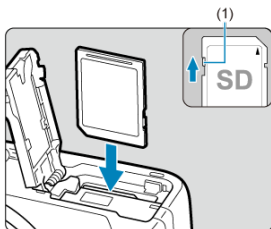

- Insert the card with the label facing the front of the camera until it clicks into place.

#### Caution

- Make sure the card's write-protect switch (1) is set upward to enable writing and erasing.

### 4. Close the cover.

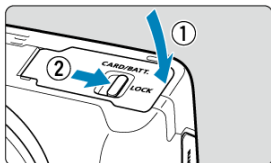

- Press the cover closed, then slide the card/battery compartment cover lock to lock it.

#### Caution

- You cannot use batteries other than the Battery Pack LP-E17.

## Formatting the Card

---

If the card is new or was previously formatted (initialized) by another camera or computer, format the card with this camera (🔗).

1. Slide the card/battery compartment cover lock and open the cover.

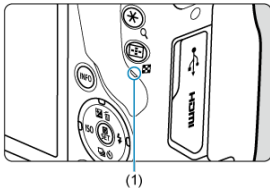

- Set the power switch to < OFF >.
- Make sure the access lamp (1) is off before opening the card/ battery compartment cover.
- If [Saving...] is displayed on the screen, close the cover.

2. Removing the battery.

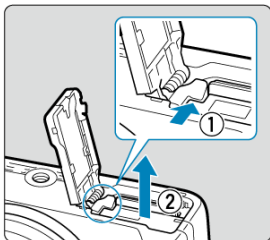

- Press the battery lock lever as shown by the arrow and remove the battery.
- To prevent short-circuits, always attach the included protective cover (🔒) to the battery.

### 3. Remove the card.

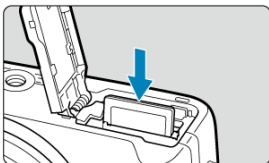

- Gently push in the card, then let it go to eject.

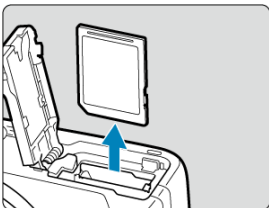

- Pull the card straight out, then close the cover.

#### Caution

**Do not remove cards immediately after a red [ ] icon is displayed as you are shooting.** Cards may be hot, due to high internal camera temperature. Set the power switch to < OFF > and stop shooting for a while before removing cards. Removing hot cards immediately after shooting may cause you to drop and damage them. Be careful when removing cards.

#### Note

- The number of shots available varies depending on remaining card capacity and settings such as image quality and ISO speed.

 **Caution**

- **When the access lamp is lit or blinking, it indicates that images are being written to, read from, or erased from the card, or data is being transferred. Do not open the card/battery compartment cover. To avoid corrupting image data or damaging cards or the camera, never do any of the following while the access lamp is lit or blinking.**
  - **Removing the card.**
  - **Removing the battery.**
  - **Shaking or striking the camera.**
  - **Unplugging or plugging in a power cord**  
(when using optional household power outlet accessories).
- If the card already contains recorded images, the image number may not start from 0001 (🔗).
- If a card-related error message is displayed on the screen, remove and reinsert the card. If the error persists, use a different card.  
If you can transfer images on the card to a computer, transfer all the images and then format the card with the camera (🔗). The card may then return to normal.
- Do not touch the card's contacts with your fingers or metal objects. Do not expose the contacts to dust or water. If smudges adhere to the contacts, contact failure may result.
- Multimedia cards (MMC) cannot be used. (Card error will be displayed.)

## Turning on the Power

---

[Setting the Date, Time, and Time Zone](#)

[Setting the Display Language](#)

[Battery Level Indicator](#)

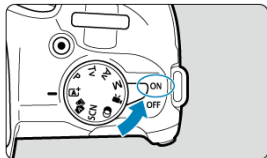

- **<ON>**

The camera turns on. You can now shoot still photos and record movies.

- **<OFF>**

The camera is turned off and does not function. Set the power switch to this position when not using the camera.



### Note

- **[Saving...]** is displayed if you set the power switch to **<OFF>** during image recording to the card, and the camera will turn off after recording is finished.

## Setting the Date, Time, and Time Zone

---

If the **[Date/Time/Zone]** setting screen is displayed after you turn on the camera, complete the [Date/Time/Zone](#) settings.



## Setting the Display Language

---

To change the interface language, see [Language](#).

## Battery Level Indicator

When the power switch is set to < ON >, the battery level will be indicated.



	Battery level is sufficient.
	Battery level is low, but the camera can still be used.
	Battery will be exhausted soon (blinks).
	Charge the battery.

### Note

- Doing any of the following will exhaust the battery faster:
  - Pressing the shutter button halfway for a prolonged period.
  - Activating the AF frequently without taking a picture.
  - Using Image Stabilizer.
  - Using the Wi-Fi function or Bluetooth function.
  - Using the screen frequently.
- The number of available shots may decrease depending on the actual shooting conditions.
- Lens operations are powered by the camera's battery. Certain lenses may exhaust the battery faster than others.
- In low ambient temperatures, shooting may not be possible even with a sufficient battery level.

## Attaching and Detaching RF/RF-S Lenses

---

 [Attaching a Lens](#)

 [Detaching a Lens](#)

### Caution

- Do not look at the sun directly through any lens. Doing so may cause loss of vision.
- When attaching or detaching a lens, set the camera's power switch to < **OFF** >.
- If the front part (focusing ring) of the lens rotates during autofocusing, do not touch the rotating part.

### Tips for avoiding smudges and dust

- When changing lenses, do it quickly in a place with minimal dust.
- When storing the camera without a lens attached, be sure to attach the body cap to the camera.
- Remove smudges and dust on the body cap before attaching it.

### 1. Remove the caps.

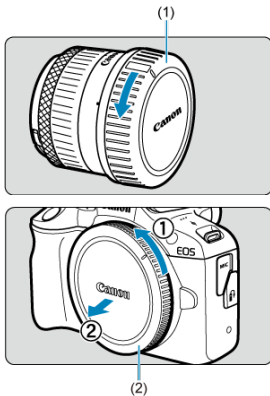

- Remove the rear lens cap (1) and body cap (2) by turning them as shown by the arrows.

### 2. Attach the lens.

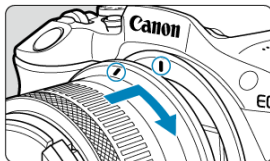

- Align the red mount index on the lens with the red mount index on the camera and turn the lens as shown by the arrow until it clicks in place.

### 3. Set the focus mode to <AF>.

- <AF> stands for autofocus.
- <MF> stands for manual focus. Autofocus is disabled.

- **For RF lenses without a focus mode switch**

Set [📷: Focus mode] to [AF].

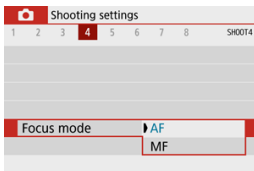

#### Note

- Not available in <A+> or <A-+> mode.

- **For RF lenses with a focus mode switch**

Set the lens focus mode switch to < AF >. Because the setting on the lens takes precedence, the camera setting has no effect.

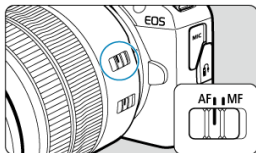

#### **4. Remove the front lens cap.**

## Detaching a Lens

While pressing the lens release button, turn the lens as shown by the arrow.

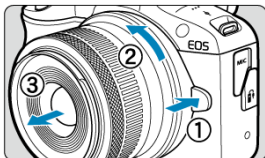

- Turn the lens until it stops, then detach it.
- Attach the rear lens cap to the lens you removed.

## Attaching and Detaching EF/EF-S Lenses

---

[Attaching a Lens](#)

[Detaching a Lens](#)

All EF and EF-S lenses can be used by attaching an optional Mount Adapter EF-EOS R.  
**The camera cannot be used with EF-M lenses.**

---

### Attaching a Lens

---

#### 1. Remove the caps.

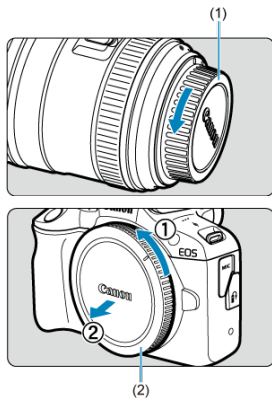

- Remove the rear lens cap (1) and body cap (2) by turning them as shown by the arrows.



## 2. Attach the lens to the adapter.

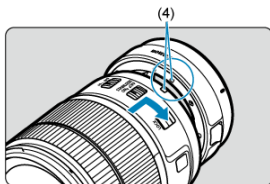
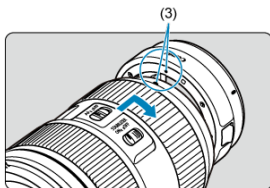

- Align the red or white mount index on the lens with the corresponding mount index on the adapter and turn the lens as shown by the arrow until it clicks into place.

(3) Red index

(4) White index

## 3. Attach the adapter to the camera.

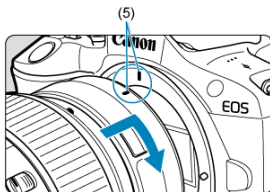

- Align the red mount indexes (5) on the adapter and camera and turn the lens as shown by the arrow until it clicks into place.

**4. Set the lens's focus mode switch to < AF >.**

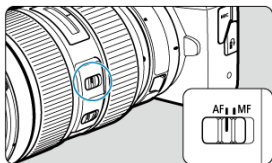

- < AF > stands for autofocus.
- < MF > stands for manual focus. Autofocus is disabled.

**5. Remove the front lens cap.**

## Detaching a Lens

1. While pressing the lens release button, turn the adapter as shown by the arrow.

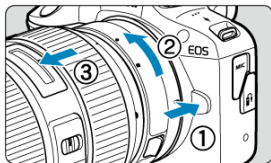

- Turn the lens until it stops, then detach it.

2. Detach the lens from the adapter.

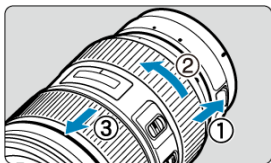

- Hold down the lens release lever on the adapter and turn the lens counterclockwise.
- Turn the lens until it stops, then detach it.
- Attach the rear lens cap to the lens you removed.

### Caution

- For lens precautions, see [Attaching and Detaching RF/RF-S Lenses](#).

## Using the Viewfinder

---

### [Dioptric Adjustment](#)

Look through the viewfinder to activate it. You can also restrict display to either the screen or viewfinder ().

---

## Dioptric Adjustment

---

1. Slide the dioptric adjustment slider.

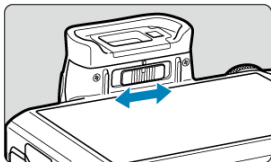

- Slide the slider left or right to make the viewfinder display look sharp.

### Caution

- The viewfinder and screen cannot be activated at the same time.
- At some aspect ratios, black bars are displayed on the top and bottom or left and right edges of the screen. These areas are not recorded.

## Basic Operations

---

[Holding the Camera](#)

[Shutter Button](#)

[☀️ Dial](#)

[⌚ Control Ring](#)

[ℹ️ Info Button](#)

## Holding the Camera

To obtain sharp images, hold the camera still to minimize camera shake.

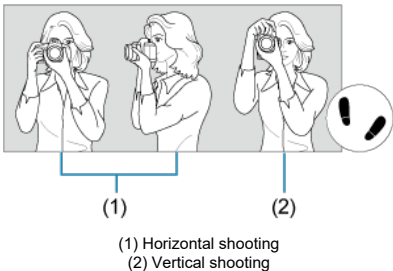

1. With your right hand, hold the camera firmly by the camera grip.
2. With your left hand, support the lens from below.
3. Rest your right index finger lightly on the shutter button.
4. Rest your arms and elbows lightly against the front of your body.
5. To maintain a stable stance, place one foot slightly ahead of the other.
6. Hold the camera near your face and look through the viewfinder.

## Shutter Button

The shutter button has two steps. You can press the shutter button halfway. Then you can further press the shutter button completely.

### Pressing halfway

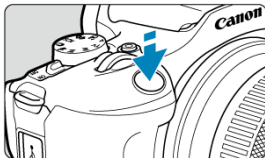

This activates autofocus and the automatic exposure system that sets the shutter speed and aperture value.

The exposure value (shutter speed and aperture value) is displayed on the screen or in the viewfinder for 8 sec. (metering timer/Ⓢ).

### Pressing completely



This releases the shutter and takes the picture.

### ● Preventing camera shake

Hand-held camera movement during the moment of exposure is called camera shake. It can cause blurred pictures. To prevent camera shake, note the following:

- Hold the camera still, as shown in [Holding the Camera](#).
- Press the shutter button halfway to autofocus, then slowly press the shutter button completely.



#### Note

- The camera will still pause before taking a picture if you press the shutter button completely without pressing it halfway first, or if you press the shutter button halfway and immediately press it completely.
- Even during menu display or image playback, you can return to shooting standby by pressing the shutter button halfway.



## < > Dial

---

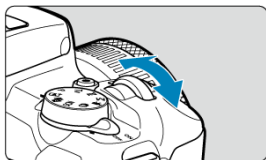

Watch the screen as you turn the <  > dial.

- Use this dial to set the shutter speed, aperture value, etc.

## <C> Control Ring

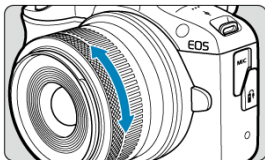

Exposure compensation can be set by turning an RF lens control ring while pressing the shutter button halfway in <P>, <Tv>, <Av>, or <M> mode.

### ⚠ Caution

- [📷: Focus/control ring] must be set when using lenses that have a combination focus/control ring but have no switch to switch between these features (🔗).
- The control ring of Control Ring Mount Adapter EF-EOS R has no effect.

## <INFO> Info Button

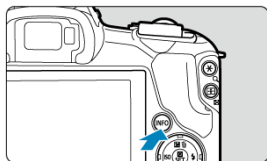

Each press of the <INFO> button changes the information shown. The following sample screens are for still photos.

(1)



(5)



(2)



(4)

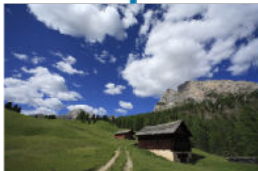

(3)



\* In Basic Zone modes, the screen by (5) is not displayed.

# Setting the Screen Display Level

---

[Menu Display](#)

[Shooting Mode Guide](#)

[Feature Guide](#)

You can set how information is displayed on the screen according to your preference. Change the settings as necessary.

---

## 1. Display the main tabs.



- Press the <MENU> button to display the menu screen.

## 2. Select the [📷] tab.

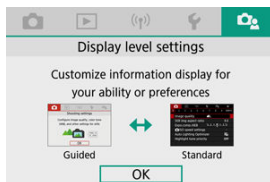

- Turn the < 🌞 > dial or press the < ◀▶▶ > keys to select the [📷] tab, then press < Ⓜ >.

## Menu Display

You can choose from [Standard] or [Guided] as the type of menu display. When set to [Guided], the camera displays main tab descriptions after you press the < MENU > button. When set to [Standard], the camera only displays the menu screen after you press the < MENU > button. The default setting is [Guided].

## 1. Select [📷: Menu display].

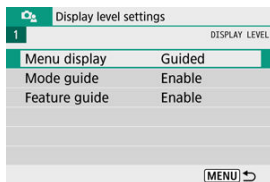

## 2. Select the display type.

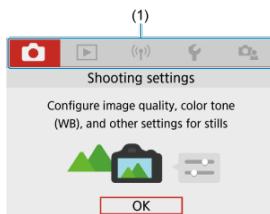
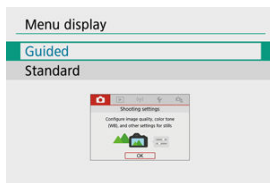

(1) Main tabs

### Note

- The [★] tab (My Menu tab) is not displayed when [Guided] is set. For access to My Menu (☑), change the menu display level to [Standard].

## Shooting Mode Guide

A brief description of the shooting mode can be displayed when you switch shooting modes. The default setting is **[Enable]**.

### 1. Select [Mode guide].

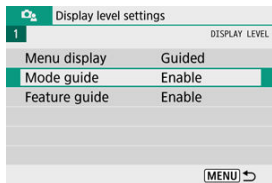

### 2. Select [Enable].

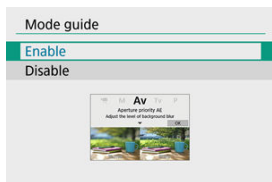

### 3. Turn the Mode dial.

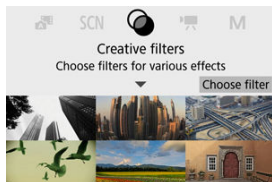

- A description of the selected shooting mode will appear.

#### 4. Press the <▼> key.

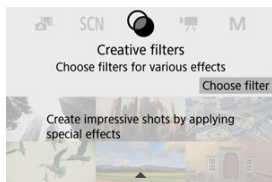

- The rest of the description will appear.
- To clear the mode guide, press <Ⓜ>.
- In < **SCN** >/<🌀> mode, you can display the shooting mode selection screen.



## Feature Guide

A brief description of functions and items can be displayed when you use Quick Control or menu settings. The default setting is **[Enable]**.

### 1. Select [**Feature guide**].

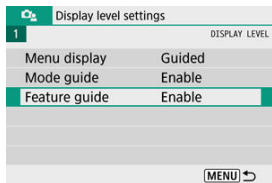

### 2. Select [**Enable**].

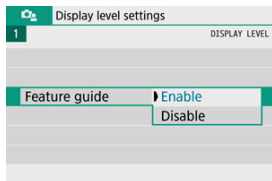

## Sample screens

### Quick Control screen

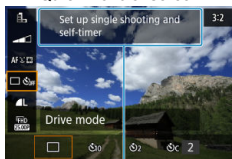

(1)

### Menu Screen

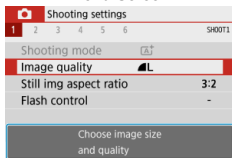

(1)

(1) Feature guide

#### Note

- To clear a description, continue performing operations.

## Menu Operations and Settings

[Menu Screen](#)

[Menu Setting Procedure](#)

[Dimmed Menu Items](#)

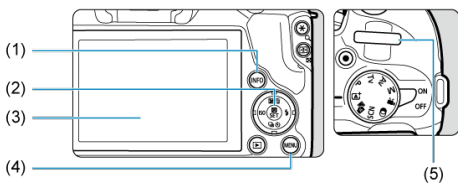

---

(1) <INFO> button

---

(2) <DISP> button

---

(3) Screen

---

(4) <MENU> button

---

(5) <☀> Dial

---

## Menu Screen

The menu tabs and items displayed vary depending on the shooting mode.

### Basic Zone

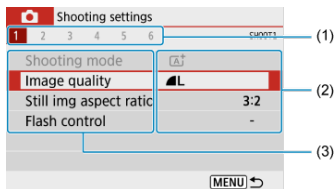

### Movie recording

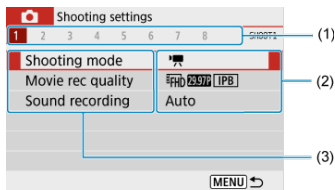

### Creative Zone

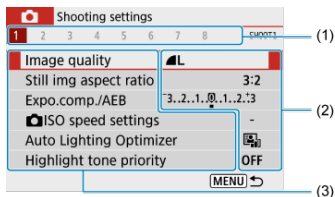

(1) Secondary tabs

(2) Menu settings

(3) Menu items

When set to [ : Menu display: Guided]

### 1. Display the main tabs.

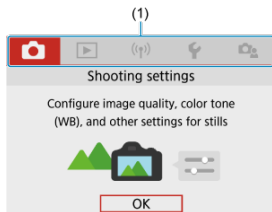

- When you press the < MENU > button, the main tabs (1) and a description of the selected tab will appear.

### 2. Select a main tab.

- Turn the <  > dial to switch between main tabs.
- You can also switch main tabs by pressing the < INFO > button.

### 3. Display the menu screen.

- Press the <  > button to display the menu screen.
- To return to the main tab screen, press the < MENU > button.

#### 4. Select a secondary tab.

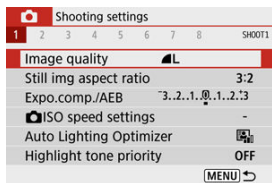

- Use the <◀>>▶> keys or turn the <☀> dial to select a secondary tab.

#### 5. Select an item.

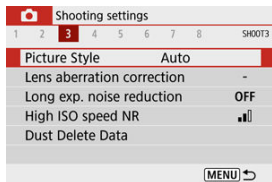

- Use the <▲>>▼> keys to select an item, then press the <Ⓜ> button.

#### 6. Select an option.

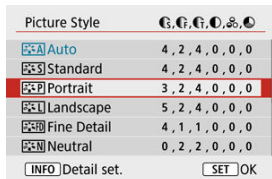

- Use the <▲>>▼> or <◀>>▶> keys to select an option. (Some options are selected with the <▲>>▼> keys and others with the <◀>>▶> keys.)
- The current setting is indicated in blue.

## 7. Set an option.

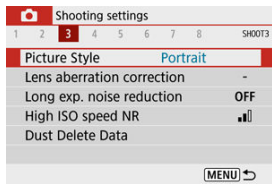

- Press the < > button to set it.
- If you change the setting from the default, it will be indicated in blue (available only for the menu items under the tab).

## 8. Exit the setting.

- Press the < MENU > button twice to exit the menu and return to shooting standby.

### Note

- The description of menu functions hereafter assumes that the menu screen is displayed.
- To cancel the operation, press the < MENU > button.

## When set to [📷: Menu display: Standard]

### 1. Display the menu screen.

- Press the < MENU > button to display the menu screen.

### 2. Select a tab.

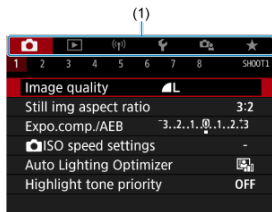

- Press the < INFO > button to switch between main tabs (1).
- Use the < ◀ ▶ > keys or turn the < 🌞 > dial to select a secondary tab.
- After this, operations are the same as when set to [📷: Menu display: Guided]. See [When set to \[📷: Menu display: Guided\]](#), starting with step 5.
- To exit the setting, press the < MENU > button once.



## Dimmed Menu Items

Example: When set to **[Highlight tone priority]**

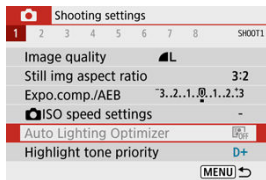

Dimmed menu items cannot be set. The menu item is dimmed if another function setting is overriding it.



You can see the overriding function by selecting the dimmed menu item and pressing the **< (G) >** button.

If you cancel the overriding function's setting, the dimmed menu item will become settable.

### Caution

- You may not be able to see the overriding function for certain dimmed menu items.

### Note

- You can reset menu functions to default settings in **[Basic settings]**, in **[Reset camera]** (🔗).

## Quick Control

---

[During Shooting](#)



[During Playback](#)

You can directly select and set the settings displayed on the screen.

---

### During Shooting



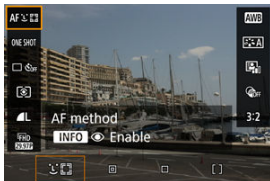

---

1. Press the <  > button (  ).
2. Select an item.





- Press the <  ><  > keys for selection.



- When the screen above is displayed, press the <  ><  ><  ><  > keys for selection.

### 3. Select an option.

- Turn the <  > dial or press the < ◀ ▶ > keys to adjust the setting. Some items are set by pressing a button after this.
- Press the <  > button to return to the original screen.

1. Press the **< [MENU] >** button.
2. Select an item.

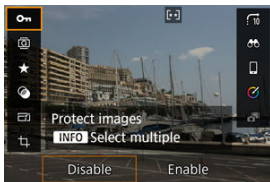

- Press the **< ▲ >< ▼ >** keys for selection.
3. Select an option.
    - Turn the **< [Sun] >** dial or press the **< ◀ ▶ >** keys to adjust the setting. Some items are set by pressing a button after this.
    - To configure items for which a **[SET]** icon appears at the bottom of the screen, press the **< [MENU] >** button.
    - To cancel this operation, press the **< MENU >** button.
    - Press the **< [MENU] >** button to return to the original screen.

### Caution

- For image rotation, set **[⚙: Auto rotate]** to **[On [Camera] [Rotate]]** (). When **[⚙: Auto rotate]** is set to **[On [Camera]]** or **[Off]**, images will be tagged with your selected **[⚙ Rotate stills]** option but not rotated on the camera.

### Note

- For images from other cameras, available options may be restricted.

## Basic Zone

---

This chapter describes how to use the Basic Zone modes on the Mode dial for best results. With Basic Zone modes, all you do is point and shoot, and the camera sets everything automatically.

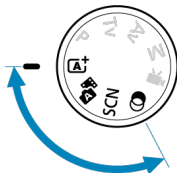
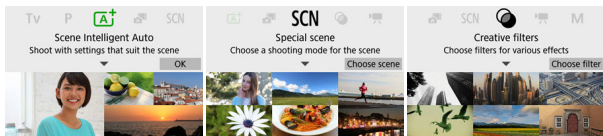

- [Scene Intelligent Auto](#)
- [Hybrid Auto](#)
- [Special Scene Mode](#)
- [Portrait Mode](#)
- [Landscape Mode](#)
- [Sports Mode](#)
- [Panning Mode](#)
- [Close-up Mode](#)
- [Food Mode](#)
- [Night Portrait Mode](#)
- [Handheld Night Scene Mode](#)
- [HDR Backlight Control Mode](#)
- [Silent Shutter Mode](#)
- [Creative Filters Mode](#)

# Scene Intelligent Auto

---

- [Shooting Moving Subjects](#)
- [Scene Icons](#)
- [Shooting with Effects Applied \(Creative Assist\)](#)

<A+> is a fully automatic mode. The camera analyzes the scene and sets the optimum settings automatically. It can also adjust focus automatically on either the still or moving subject by detecting the motion of the subject (A+).

---

1. Set the Mode dial to <A+>.

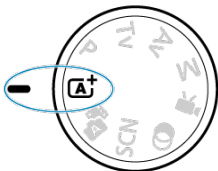

2. Press the <A+> button.

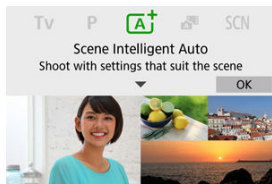

- Read the message and select [OK].

### 3. Aim the camera at what you will shoot (the subject).

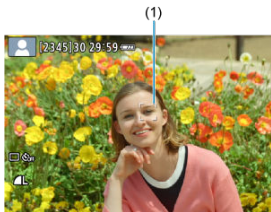

- Essentially, the camera focuses on the closest subject. AF points (1) are displayed over any faces or eyes detected.
- When a frame (AF point) appears on the screen, aim it over the subject.

### 4. Focus on the subject.

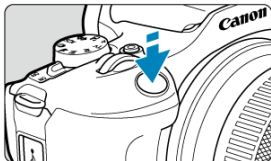

- Press the shutter button halfway to focus. If < lightning bolt icon > blinks, manually raise the built-in flash.
- Under low light, the AF-assist beam (📷) is automatically activated if needed.
- Once the subject is in focus, that AF point turns green and the camera beeps (One-Shot AF).
- An AF point in focus on a moving subject turns blue and tracks subject movement (Servo AF).

## 5. Take the picture.

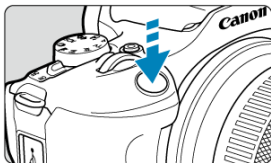

- Press the shutter button completely to take the picture.
- The image just captured will be displayed for approx. 2 sec. on the screen.
- To retract the built-in flash, push it down with your fingers.

### ! Caution

- Subject movement (whether subjects are still or moving) may not be detected correctly for some subject or shooting conditions.

### 📄 Note

- AF operation (One-Shot AF or Servo AF) is set automatically when you press the shutter button halfway. Even when automatically set to One-Shot AF, the camera will switch to Servo AF if subject motion is detected while you are pressing the shutter button halfway.
- The < **A**+ > mode makes the colors look more impressive in nature, outdoor, and sunset scenes. If you do not obtain the desired color tones, change the mode to a Creative Zone mode (📷) and select a Picture Style other than [A], then shoot again (📷).

## 💡 Minimizing blurred photos

- Be careful about camera shake in handheld shots. To avoid camera shake, consider using a tripod. Use a sturdy tripod that can bear the weight of the shooting equipment. Attach the camera securely to the tripod.
- Consider using a remote switch (sold separately, 📷) or wireless remote control (sold separately, 📷).



## ? FAQ

---

- **Focusing is not possible (indicated by an orange AF point).**  
Aim the AF point over an area with good contrast, then press the shutter button halfway (Ⓢ). If you are too close to the subject, move away and shoot again.
- **Multiple AF points are displayed simultaneously.**  
Focus has been achieved at all those points.
- **The shutter speed display is blinking.**  
Since it is too dark, taking the picture may result in a blurred subject due to camera shake. Using a tripod, the built-in flash, or an external flash (Ⓢ) is recommended.
- **Pictures are too dark.**  
Raise the built-in flash in advance to enable automatic flash firing, in case subjects in daytime shots are backlit, or when shooting under low light.
- **Pictures taken with flash are too bright.**  
Pictures may be bright (overexposed) if you shoot subjects at close range in flash photography. Move away from the subject and shoot again.
- **The bottom part of pictures taken with flash is unnaturally dark.**  
Shooting subjects that are too close may make the shadow of the lens visible in your shots. Move away from the subject and shoot again. If you are using a lens hood, try removing it before shooting.



### Note

Note the following if you are not using the built-in flash.

- Under low light, when camera shake tends to occur, hold the camera steady or use a tripod. When using a zoom lens, you can reduce the blur caused by camera shake by setting the lens to the wide-angle end.
- When shooting portraits under low light, tell subjects to stay still until you have finished shooting. Any movement as you shoot will make the person look blurry in the picture.

## Shooting Moving Subjects

---



Pressing the shutter button halfway tracks moving subjects to keep them in focus. Keep the subject on the screen as you hold down the shutter button halfway, and at the decisive moment, press the shutter button completely.

## Scene Icons

---





The camera detects the scene type and sets everything automatically to suit the scene. In still photo shooting, an icon representing the detected scene appears in the upper left of the screen (👤).



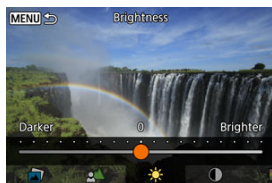







### 3. Select the effect level and other details.



- Set with the <  > dial or < ◀ ▶ > keys, then press the <  > button.
- To reset the setting, press the <  > button, then select [OK].

## Creative Assist effects

-  **Preset**  
Select one of the preset effects.  
Note that **[Saturation]**, **[Color tone 1]**, and **[Color tone 2]** are not available with **[B&W]**.
-  **Background blur**  
Adjust background blur. Choose higher values to make backgrounds sharper. To blur the background, choose lower values. **[Auto]** adjusts background blurring to match the brightness. Depending on lens brightness (f/number), some positions may not be available.
-  **Brightness**  
Adjust image brightness.
-  **Contrast**  
Adjust contrast.
-  **Saturation**  
Adjust the vividness of colors.
-  **Color tone 1**  
Adjust amber/blue color tone.
-  **Color tone 2**  
Adjust green/magenta color tone.
-  **Monochrome**  
Set the toning effect for monochrome shooting.

### Note

- **[Background blur]** is not available in flash photography.
- These settings are reset when you switch shooting modes or set the power switch to **< OFF >**. To save the settings, set  **Retain Creative Assist data** to **[Enable]**.



## Saving effects

To save the current setting to the camera, press the **< INFO >** button on the **[Creative Assist]** setting screen, then select **[OK]**. Up to three presets can be saved as **[USER\*]**. After three have been saved, an existing **[USER\*]** preset must be overwritten to save a new one.

# Hybrid Auto

---

## [Type of Digest Movie](#)

With <  > mode, you can make a short movie of the day just by shooting still photos. The camera records 2–4-second clips of scenes before each shot, which are later combined in a digest movie ().

---

1. Set the Mode dial to <  >.

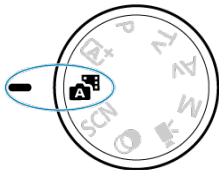



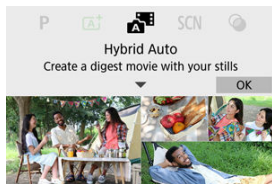

2. Press the <  > button.

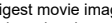
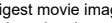

- Read the message and select [OK].
- Compose your shots and shoot.

 **Note**

- For more impressive digest movies, keep the camera aimed at subjects for about 4 sec. before shooting still photos.
- Battery life is shorter in this mode than in <  > mode, because digest movies are recorded for each shot.
- A digest movie may not be recorded if you shoot a still photo immediately after turning the camera on, selecting <  > mode, or operating the camera in other ways.
- Any sounds and vibrations from your camera or lens operations will be recorded in digest movies.
- Digest movie image quality is  for NTSC or  for PAL. This varies depending on the video system setting.
- The camera does not beep in response to operations such as pressing the shutter button halfway or using the self-timer.
- Digest movies are saved as separate movie files in the following cases even if they were recorded on the same day in <  > mode.
  - Digest movie recording time reaches approx. 29 min. and 59 sec. (and may also be saved separately if size exceeds approx. 4 GB).
  - Digest movie is protected.
  - Daylight saving time, video system, or time zone settings are changed.
- Recorded shutter sounds cannot be modified or erased.
- When using EOS Utility to shoot, set **[Image saving location]** in EOS Utility to **[Computer and camera memory card]** or **[Camera memory card only]**.



## Type of Digest Movie

Both still photos and clips are captured when you shoot in <  > mode, but you can specify whether to include the still photos in the resulting digest movie.

1. Set the Mode dial to <  >.

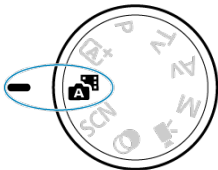

2. Select [: Digest type].

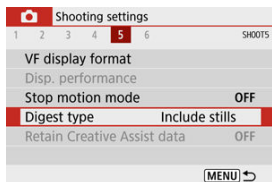

### 3. Select an option.

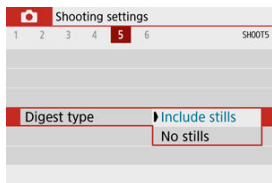

- **Include stills**  
Digest movies include still photos.
- **No stills**  
Digest movies do not include still photos.

# Special Scene Mode

---

The camera will automatically choose the appropriate settings when you select a shooting mode for your subject or scene.

\* < **SCN** > stands for Special Scene.

---

1. Set the Mode dial to < **SCN** >.

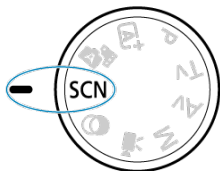

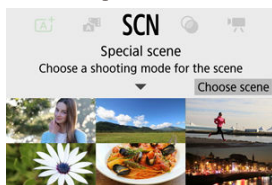

2. Press the <  > button.

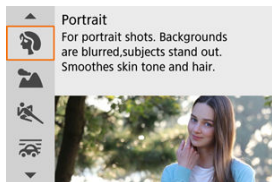

3. Select a shooting mode.













- Use the <  > dial or <  ><  > keys to select a shooting mode, then press the <  > button.



## Note

- You can also set the shooting mode in [: **Shooting mode**].
- When [: **Mode guide**] is set to [**Disable**], after step 1, press the < > button to access the Quick Control screen, use the < > dial or < >< > keys to select a shooting mode, then press the < > button.

## Available Shooting Modes in <SCN> Mode

Shooting Mode			
	<a href="#">Portrait</a>		<a href="#">Food</a>
	<a href="#">Landscape</a>		<a href="#">Night Portrait</a>
	<a href="#">Sports</a>		<a href="#">Handheld Night Scene</a>
	<a href="#">Panning</a>		<a href="#">HDR Backlight Control</a>
	<a href="#">Close-up</a>		<a href="#">Silent Mode</a>

## Portrait Mode

---

Use [👤] (Portrait) mode to blur the background and make the person you shoot stand out. It also makes skin tones and hair look softer.

---

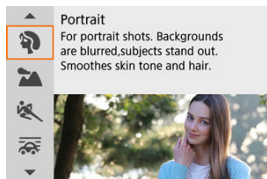

### Shooting tips

---

- **Select the location where the distance between the subject and the background is the farthest.**

The further the distance between the subject and background, the more blurred the background will look. The subject will also stand out better against an uncluttered dark background.

- **Use a telephoto lens.**

If you have a zoom lens, use the telephoto end to fill the frame with the subject from the waist up.

- **Focus on the face.**

As you focus before shooting, make sure the AF point on the subject's face is green.

When shooting close-ups of faces, you can set [👁️: Eye detection] to [Enable] to shoot with the subject's eyes in focus.

- **Shoot continuously.**

The default setting is [📷] (Continuous shooting). If you keep holding down the shutter button, you can shoot continuously to capture changes in the subject's facial expression and pose.

## Landscape Mode

---

Use [🏔️] (Landscape) mode for expansive scenery, to keep everything in focus from near to far. For vivid blues and greens, and sharp and crisp images.

---

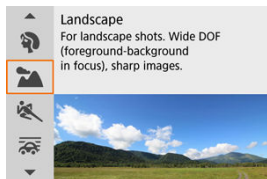

### 💡 Shooting tips

---

- **With a zoom lens, use the wide-angle end.**

When using a zoom lens, set the lens to the wide-angle end to make the objects near and far in focus. It also adds breadth to landscapes.

- **Keep the camera steady when shooting night scenes.**

Using a tripod is recommended.

#### ⚠️ Caution

- Flash photography is not available.

## Sports Mode

---

Use [Fn] (Sports) mode to shoot subjects in motion, such as runners or moving vehicles.

---

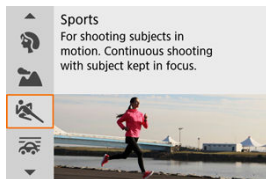

### Shooting tips

---

- **Use a telephoto lens.**

Use of a telephoto lens is recommended to enable shooting from a distance.

- **Track the subject with the Area AF frame.**

An Area AF frame appears after you press the shutter button halfway. Once the subject is in focus, the AF point turns blue.

- **Shoot continuously.**

The default setting is [Fn] (**Continuous shooting**). At the decisive moment, press the shutter button completely to take the picture. To track the subject and capture changes as it moves, keep holding down the shutter button to shoot continuously.

#### Caution

- Under low light where camera shake tends to occur, the shutter speed value in the lower left will blink. Hold the camera steady and shoot.
- Flash photography is not available.



## Panning Mode

---

By panning, you can blur the background to convey a sense of speed.

Attach a lens compatible with  (Panning) mode to reduce subject blurring and keep subjects clear and sharp.

---

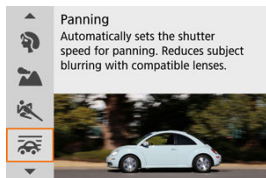

### Shooting tips

---

- **Turn the camera to follow the moving subject.**

As you shoot, turn the camera smoothly while tracking the moving subject. With the AF point over the part of the moving subject to focus on, press the shutter button halfway, start turning the camera to keep up with the subject, then press the shutter button completely to shoot. Continue tracking the subject with the camera after this.

- **Set the level of background motion blur.**

In [Effect], you can set the level of background motion blur. Set to [Effect: max] for a slower shutter speed and more background motion blur around subjects. If subject blur is excessive, reduce it by setting [Effect] to [Effect: med] or [Effect: min].

## Caution

- Dust may be more noticeable in images, because it is easier to stop down the aperture. Consider acquiring Dust Delete Data before shooting. (🔗)
- For details on lenses compatible with [🔗] mode, visit the Canon website.
- Shutter speeds are slower. For this reason, Panning mode is not suitable unless you pan as you shoot.
- The default setting is [🔗].
- Flash photography is not available.
- Although lens IS is applied to images captured with lenses supporting [🔗] mode, the effect is not shown on the screen as you shoot. (IS and subject blur correction are activated when you shoot, regardless of the lens IS setting.)
- With lenses that do not support [🔗] mode, subject blur is not reduced, but shutter speed is automatically adjusted to match the [Effect] setting.
- Your specified panning effect level may not be applied when shooting under bright light (such as on sunny summer days), or when shooting slow subjects.
- The following subjects or shooting conditions may prevent suitable subject blur correction with lenses supporting [🔗] mode.
  - Subjects with very low contrast.
  - Subjects in low light.
  - Strongly backlit or reflective subjects.
  - Subjects with repetitive patterns.
  - Subjects with few patterns, or with monotone patterns.
  - Subjects with reflections (such as images reflected in glass).
  - Subjects smaller than the Zone AF frame.
  - Multiple subjects moving within a Zone AF frame.
  - Subjects moving in irregular directions or at irregular speeds.
  - Subjects who sometimes move erratically (such as runners who move up and down as they run).
  - Subjects whose speed changes greatly (such as immediately after initial movement, or when moving along a curve).
  - When the camera moves too quickly or slowly.
  - When camera movement does not match subject movement.
  - With long lens focal lengths.

## Close-up Mode

---

Use [🌸] (Close-up) mode for close-ups of small subjects such as flowers. To make small things appear much larger, use a macro lens (sold separately).

---

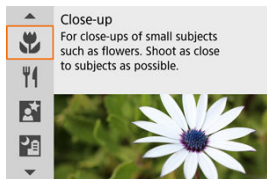

### 💡 Shooting tips

---

- **Use a simple background.**  
A simple background makes small objects such as flowers stand out better.
- **Move in as close as possible to the subject.**  
Check the lens for its minimum focusing distance. The lens minimum focusing distance is measured from the <math>\ominus</math> (focal plane) mark on the top of the camera to the subject. Focusing is not possible if you are too close.
- **With a zoom lens, use the telephoto end.**  
If you have a zoom lens, using the telephoto end will make the subject look larger.
- **When [🔆] blinks**  
Manually raise the built-in flash.

## Food Mode

---

Use [F] (Food) mode for culinary photography. The photo will look bright and appetizing. Also, the reddish tinge due to the light source will be suppressed in the pictures taken under tungsten lights, etc.

---



### Shooting tips

---

#### ● Change the color tone.

[Color tone] can be adjusted. To increase the reddish tinge of food, set toward [Warm tone] (red), or set toward [Cool tone] (blue) if it looks too red.

#### Caution

- The warm color cast of subjects may appear faded.
- When multiple light sources are included in the scene, the warm color cast of the picture may not be reduced.
- In flash photography, [Color tone] switches to the standard setting.
- If there are people in the picture, the skin tone may not be reproduced properly.

## Night Portrait Mode

Use **[P]** (Night Portrait) mode for bright, beautiful shots of people with night scenes in the background. **Note that shooting in this mode requires the built-in flash or a Speedlite.** Using a tripod is recommended.

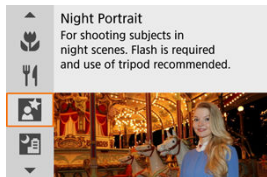

### Shooting tips

- **Use a wide-angle lens and a tripod.**

When using a zoom lens, use the wide-angle end to obtain a wide night view. Because camera shake occurs in handheld shooting, using a tripod is also recommended.



- **Check the image brightness.**

It is recommended to play back the captured image on location to check the image brightness. If the subject looks dark, move nearer and shoot again.

- **Also shoot in other shooting modes.**

Consider also shooting in **< [A+] >** and **[P]** mode, because shots are more likely to be blurry.

#### Caution

- Tell subjects to remain still for a moment after the flash fires.
- Focusing may be difficult if subject faces look dark when you shoot. In this case, set the focus mode to MF () and focus manually.
- Autofocusing at night or in dark scenes may be difficult when points of light lie within the AF point. In this case, set the focus mode to MF () and focus manually.
- Shots will look slightly different from the preview image shown on the screen.
- When there is a risk of overexposure in flash photography, shutter speed or ISO speed is automatically adjusted to reduce loss of detail in highlights and shoot at standard exposure. In flash shots with certain lenses, the shutter speeds and ISO speeds displayed when you press the shutter button halfway may not match the actual settings used. This may alter the brightness of backgrounds that are out of flash range.



#### Note

- The self-timer lamp fires briefly after shots in this mode if the self-timer is used.

## Handheld Night Scene Mode

---

 (Handheld Night Scene) mode enables handheld shooting for night scenes. In this shooting mode, four shots are taken consecutively for each picture, and the resulting image with reduced camera shake is recorded.

---

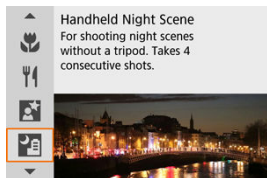

### Shooting tips

---

- **Hold the camera steady.**

Keep your elbows close to your body to hold the camera steady (). In this mode, four shots are aligned and merged into a single image, but if there is significant misalignment in any of the four shots due to camera shake, they may not align properly in the final image.

- **For portraits, use an external flash unit.**

If your shots will include people, use an external flash unit. For nicer portraits, flash is used for the first shot. Tell the subject not to move until all four consecutive shots are taken.

## Caution

- Compared to other shooting modes, the image area will be smaller.
- RAW image quality cannot be set.
- Autofocusing at night or in dark scenes may be difficult when points of light lie within the AF point. In this case, set the focus mode to MF () and focus manually.
- Flash photography is available only with an external flash unit attached.
- Shooting subjects at close range with an external flash unit may cause overexposure.
- Using an external flash unit in night scenes with limited lighting may result in blurry pictures from misaligned images.
- Using an external flash unit that illuminates both people and a nearby background may result in blurry pictures from misaligned images. Unnatural shadows and unsuitable colors may also appear.
- Flash coverage angle with a Speedlite:
  - When using a Speedlite with automatic flash coverage setting, the zoom position will be fixed to the wide (wide-angle) end regardless of the lens's zoom position.
  - When using a Speedlite requiring manual flash coverage setting, set the flash head to the normal position.
- If you shoot a moving subject, the subject's movement may leave afterimages or the surrounding area of the subject may become dark.
- The image alignment may not function properly with repetitive patterns (lattice, stripes, etc.), flat or single-tone images, or images significantly misaligned due to camera shake.
- It takes some time to record images to the card since they are merged after shooting. "BUSY" appears on the screen as images are processed, and shooting is not possible until processing is finished.
- Shots will look slightly different from the preview image shown on the screen.



## HDR Backlight Control Mode

Use [🔦] (HDR Backlight Control) mode for backlit scenes with both bright and dark areas. Shooting once in this mode captures three consecutive images at different exposures, which are combined to create a single HDR image that retains detail in shadows that might otherwise be lost from backlighting.

\* HDR stands for High Dynamic Range.

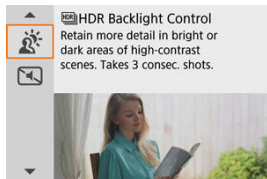

### 🔦 Shooting tips

#### ● Hold the camera steady.

Keep your elbows close to your body to hold the camera steady (🔒). In this mode, three shots are aligned and merged into a single image. However, if there is significant misalignment in any of the three shots due to camera shake, they may not align properly in the final image.

#### ⚠ Caution

- Compared to other shooting modes, the image area will be smaller.
- RAW image quality cannot be set.
- Flash photography is not available.
- Note that the image may not be rendered with a smooth gradation and may look irregular or have significant noise.
- HDR Backlight Control may not be effective for excessively backlit scenes or extremely high-contrast scenes.
- When shooting subjects that are sufficiently bright as they are, for example for normally lit scenes, the image may look unnatural due to the HDR effect.
- Shooting moving subjects may result in afterimages from the movement, or darkness around the subject.
- The image alignment may not function properly with repetitive patterns (lattice, stripes, etc.), flat or single-tone images, or images significantly misaligned due to camera shake.
- It takes some time to record images to the card since they are merged after shooting. "BUSY" appears on the screen as images are processed, and shooting is not possible until processing is finished.

## Silent Shutter Mode

---

Where silence is needed, you can shoot without beeps or shutter release sounds. As you shoot, a white frame is momentarily displayed around the screen.

---

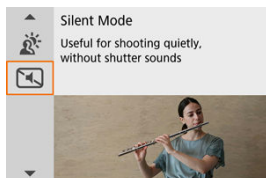

### Shooting tips

---

- **Take some test shots.**

Consider taking some test shots in advance, because lens aperture and focusing adjustment may be audible under some shooting conditions.

#### Caution

- Be responsible when using silent shooting, and respect subject privacy and portrait rights.
- Images of fast-moving subjects may look distorted.
- Continuous shooting and flash photography are not available.

# Creative Filters Mode

---

[✔ Creative Filter Characteristics](#)

[✔ Adjusting the Miniature Effect](#)

You can shoot with filter effects applied. Filter effects can be previewed before you shoot.

---

1. Set the Mode dial to .

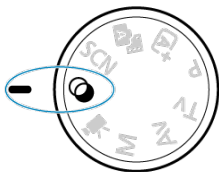

2. Press the  button.

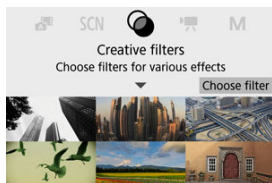

### 3. Select a filter effect.



- Use the < > dial or < >< > keys to select a filter effect (), then press the < > button.
- The image is shown with the filter effect applied.

### 4. Adjust the effect and shoot.



- Press < > and select an icon below [**Creative filters**] (except ////).
- Use the < > dial or < >< > keys to adjust the effect, then press the < > button.

#### Caution

- RAW and RAW+JPEG are not available. When RAW image quality is set, images are captured with image quality. When RAW+JPEG image quality is set, images are captured with the specified JPEG image quality.
- Continuous shooting is not available when [], [], [], [], [], or [] is set.











## Note

- With [**Grainy B/W**], the grainy preview will differ somewhat from the appearance of your shots.
- With [**Soft focus**] or [**Miniature effect**] options, the blurred effect preview may differ somewhat from the appearance of your shots.
- No histogram is displayed.
- A magnified view is not available.
- In Creative Zone modes, some Creative filter settings are available from the Quick Control screen.

## Creative Filter Characteristics





---

-  **Grainy B/W**  
Makes the image grainy and black and white. By adjusting the contrast, you can change the black-and-white effect.
-  **Soft focus**  
Gives the image a soft look. By adjusting the blur, you can change the degree of softness.
-  **Fish-eye effect**  
Gives the effect of a fish-eye lens. The image will have barrel distortion. Depending on the level of this filter effect, the area trimmed along the periphery of the image changes. Also, because this filter effect magnifies the center of the image, the apparent resolution at the center may degrade depending on the number of recorded pixels, so set the filter effect while checking the resulting image. One AF point is used, fixed at the center.
-  **Water painting effect**  
Makes the photo look like a watercolor painting with soft colors. By adjusting the effect, you can change the color density. Note that night scenes or dark scenes may not be rendered with a smooth gradation and may look irregular or have significant noise.
-  **Toy camera effect**  
Shifts colors to those typical of toy cameras and darkens the four corners of the image. Color tone options can be used to change the color cast.
-  **Miniature effect**  
Creates a diorama effect.  
Shooting under the default setting will keep the center looking sharp.  
To move the area that looks sharp (the scene frame), see [Adjusting the Miniature Effect](#). [1-point AF] is used as the AF method. Shooting with the AF point and scene frame aligned is recommended.
-  **HDR art standard**  
Photos retain more detail in highlights and shadows. With reduced contrast and flatter gradation, the finish resembles a painting. The subject outlines will have bright (or dark) edges.
-  **HDR art vivid**  
Colors are more saturated than with [HDR art standard], and the low contrast and flat gradation resemble graphic art.
-  **HDR art bold**  
The colors are the most saturated, making the subject pop out, and the picture looks like an oil painting.

●  **HDR art embossed**









The color saturation, brightness, contrast and gradation are decreased to make the picture look flat, so that the picture looks faded and old. The subject outlines will have intensely bright (or dark) edges.

 **Caution**

, , , and  precautions













- Compared to other shooting modes, the image area will be smaller.
- Shots will look slightly different from the filter effect previews shown on the screen.
- Shooting moving subjects may result in afterimages from the movement, or darkness around the subject.
- The image alignment may not function properly with repetitive patterns (lattice, stripes, etc.), flat or single-tone images, or images significantly misaligned due to camera shake.
- Be careful about camera shake in handheld shots.
- Subjects such as the sky or white walls may not be rendered with smooth gradation and may have noise or irregular exposure or colors.
- Shooting under fluorescent or LED lighting may result in unnatural color reproduction of the illuminated areas.
- It takes some time to record images to the card since they are merged after shooting. **BUSY** appears on the screen as images are processed, and shooting is not possible until processing is finished.
- Flash photography is not available.

 **Note**

- With , , , and , you can shoot high dynamic range photos that retain detail in highlights and shadows of high-contrast scenes. Three consecutive images are captured at different brightnesses each time you shoot and used to create a single image. See the precautions for , , , and .

### 1. Move the scene frame.



- Use the scene frame to set an area that will look sharp.
- Press the  button to enable movement of the scene frame, which turns orange. To switch the scene frame orientation, use the   keys when it is in horizontal orientation or the   keys when it is in vertical orientation.
- To move the scene frame, use the  dial or     keys. To center the scene frame again, press the  button.
- To confirm the position of the scene frame, press the  button. Next, set the AF point.



## 2. Move the AF point as needed and shoot.





- The AF point turns orange and can be moved.
- Press the <▲><▼><◀><▶> keys to move the AF point to the position to focus on.
- Aligning the AF point and scene frame is recommended.
- To return the AF point to the center of the screen, press the <INFO> button.
- To confirm the position of the AF point, press the <Ⓜ> button.

## Creative Zone

---

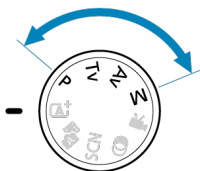
Creative Zone modes give you the freedom to shoot in a variety of ways by setting your preferred shutter speed, aperture value, exposure, and more.



- To clear the shooting mode description displayed when you turn the Mode dial, press the <  > button (  ).
- [P: Program AE](#)
- [Tv: Shutter-Priority AE](#)
- [Av: Aperture-Priority AE](#)
- [M: Manual Exposure](#)
- [Long \(Bulb\) Exposures](#)

## P: Program AE

---

The camera automatically sets the shutter speed and aperture value to suit the subject's brightness.

\* <P> stands for Program.

\* AE stands for Auto Exposure.

---

1. Set the Mode dial to <P>.

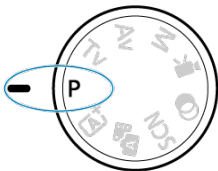

2. Focus on the subject.



- Aim the AF point over the subject and press the shutter button halfway.

3. Check the display.

- Standard exposure is available unless the shutter speed and aperture value are blinking.

4. Take the picture.

- Compose the shot and press the shutter button completely.

## Caution

- If the "30" shutter speed and the lowest aperture value blink, it indicates underexposure.  
Increase the ISO speed or use flash.
- If the "1/4000" shutter speed and the highest aperture value blink, it indicates overexposure.  
Lower the ISO speed or use an ND filter (sold separately) to reduce the amount of light entering the lens.

## Note

### Differences between <P> and <A+> modes

- In <A+> mode, many functions, such as the AF method and metering mode, are set automatically to prevent spoiled shots. The functions you can set are limited. In contrast, <P> mode only sets the shutter speed and aperture value automatically, and you can freely set the AF method, metering mode, and other functions.

### Program shift

- With Program AE, you can freely change the combination (program) of shutter speed and aperture value set by the camera while maintaining the same exposure. This is called Program shift.
- With Program shift, you can press the shutter button halfway, then turn the  dial until the desired shutter speed or aperture value is displayed.
- Program shift will be canceled automatically when the metering timer ends (exposure setting display turns off).
- Program shift cannot be used with flash.

## Tv: Shutter-Priority AE

---

In this mode, you set the shutter speed and the camera automatically sets the aperture value to obtain the standard exposure matching the brightness of the subject. A faster shutter speed can freeze the action of a moving subject. A slower shutter speed can create a blurred effect, giving the impression of motion.

\* <Tv> stands for Time value.



Blurred motion  
(Slow shutter speed: 1/30 sec.)



Frozen motion  
(Fast shutter speed: 1/2000 sec.)

- 
1. Set the Mode dial to <Tv>.

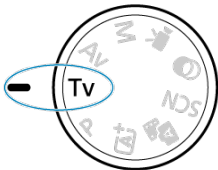

## 2. Set the desired shutter speed.

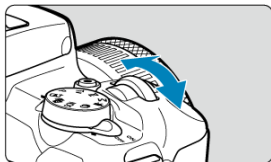

- Turn the < sun > dial to set it.

## 3. Focus on the subject.

- Press the shutter button halfway.

## 4. Check the display and shoot.



- As long as the aperture value is not blinking, the standard exposure will be obtained.

### ⚠ Caution

- If the lowest aperture value blinks, it indicates underexposure. Turn the < sun > dial to set a slower shutter speed until the aperture value stops blinking or set a higher ISO speed.
- If the highest aperture value blinks, it indicates overexposure. Turn the < sun > dial to set a faster shutter speed until the aperture value stops blinking, or set a lower ISO speed.



## Note

### Shutter speed display

- For shutter speeds slower than 1/4 sec., display changes from the denominator format to ". For example, **0"5** indicates 0.5 sec. and **15"**, 15 sec.

## Av: Aperture-Priority AE

---

In this mode, you set the desired aperture value and the camera sets the shutter speed automatically to obtain the standard exposure matching the subject brightness. A higher f/number (smaller aperture hole) will make more of the foreground and background fall within acceptable focus. On the other hand, a lower f/number (larger aperture hole) will make less of the foreground and background fall within acceptable focus.

\* <Av> stands for Aperture value (aperture opening).

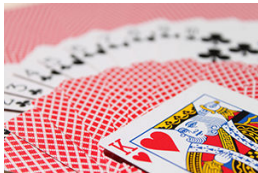

Blurred background  
(With a low aperture value: f/5.6)



Sharp foreground and background  
(With a high aperture value: f/32)

- 
1. Set the Mode dial to <Av>.

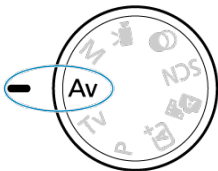



## 2. Set the desired aperture value.

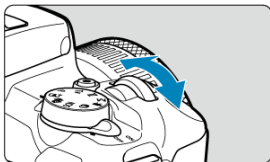

- Turn the <  > dial to set it.

## 3. Focus on the subject.

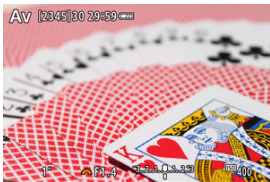

- Press the shutter button halfway.

## 4. Check the display and shoot.



- As long as the shutter speed is not blinking, the standard exposure will be obtained.

### Caution

- If the "30" shutter speed blinks, it indicates underexposure. Turn the <  > dial to decrease the aperture value (open the aperture) until the shutter speed blinking stops or set a higher ISO speed.
- If the "1/4000" shutter speed blinks, it indicates overexposure. Turn the <  > dial to increase aperture value (close the aperture) until the shutter speed blinking stops or set a lower ISO speed.



## Note

### Aperture value display

- The higher the value, the smaller the aperture opening will be. The aperture value displayed varies depending on the lens. If no lens is attached to the camera, **"F00"** will be displayed for the aperture.

## Depth-of-Field Preview

---

The aperture changes only at the moment you shoot, and it remains open at other times. For this reason, the depth of field shown on the screen looks narrow, or shallow. To check the area in focus, assign  (depth-of-field preview) to a button and press it.



### Note

- The larger the aperture value, the wider the area in focus, from the foreground to the background.
- The depth-of-field effect is readily apparent on the screen as you change the aperture value and press the button assigned to depth-of-field preview.
- Exposure is locked (AE lock) as you hold down the button assigned to depth-of-field preview.

# M: Manual Exposure

---

In this mode, you set both the shutter speed and aperture value as desired. To determine the exposure, refer to the exposure level indicator or use a commercially available exposure meter.

\* <M> stands for Manual.

---

1. Set the Mode dial to <M>.

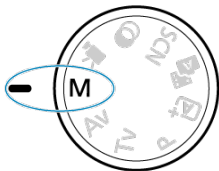

2. Set the ISO speed (☑).

- Press the < ◀ / ISO > button to set it.
- With ISO Auto, you can set exposure compensation (☑).

3. Set the desired shutter speed.



- Turn the < ☀ > dial to set it.

#### 4. Set the desired aperture value.



- Press the < ▲ > key to select the aperture value, then turn the < ☀ > dial to set a value.

#### 5. Focus on the subject.



- (1) Standard exposure index
- (2) Exposure level mark

- Press the shutter button halfway.
- Check the exposure level mark [ ] to see how far the current exposure level is from the standard exposure level.

#### 6. Set the exposure and take the picture.

- Check the exposure level indicator and set the desired shutter speed and aperture value.
- [◀] or [▶] appears at the ends of the exposure level indicator if the level exceeds  $\pm 3$  stops from standard exposure.

## Exposure Compensation with ISO Auto

If the ISO speed is set to [AUTO] for manual exposure shooting, you can set exposure compensation (☑) as follows:

- [📷]: Expo.comp./AEB]
- Turn the control ring while pressing the shutter button halfway (☑)

### ⚠ Caution

- Exposure may not be as expected when ISO Auto is set, because the ISO speed is adjusted to ensure standard exposure for your specified shutter speed and aperture value. In this case, set the exposure compensation.
- Exposure compensation is not applied in flash photography with ISO Auto, even if you have set an exposure compensation amount.

### 📷 Note

- To enable Auto Lighting Optimizer to be specified in <M> mode as well, clear the [✓] mark for [Disable during man expo] in [📷: Auto Lighting Optimizer] (☑).
- When ISO Auto is set, you can press the <✳> button to lock the ISO speed.
- If you press the <✳> button and recompose the shot, you can see the exposure level difference on the exposure level indicator compared to when the <✳> button was pressed.

## Long (Bulb) Exposures

---

In this mode, the shutter stays open as long as you hold down the shutter button completely, and closes when you let go of the shutter button. Use bulb exposures for night scenes, fireworks, astrophotography, and other subjects requiring long exposures.

---

1. Set the Mode dial to <M>.

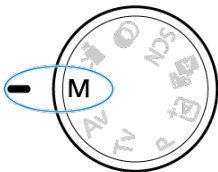

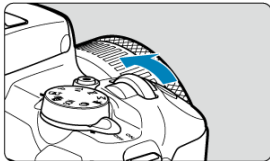

2. Set the shutter speed to [BULB].



- Turn the <  > dial to the left to set [BULB].

3. Set the desired aperture value.

- Press the <  > key to select the aperture value, then turn the <  > dial to set a value.

## 4. Take the picture.

- The exposure will continue for as long as you keep the shutter button pressed completely.
- Elapsed exposure time is shown on the screen.

### Caution

- Do not point the camera toward an intense light source, such as the sun or an intense artificial light source. Doing so may damage the image sensor or the camera's internal components.
- Long bulb exposures produce more noise in the image than usual.
- If ISO Auto is set, ISO 400 will be set (🔗).

### Note

- You can reduce the noise generated during long exposures by using [: **Long exp. noise reduction**] (🔗).
- Using a tripod is recommended for bulb exposures.
- You can also shoot bulb exposures with Remote Switch RS-60E3 (sold separately, 🔗).
- You can also shoot bulb exposures by using Wireless Remote Control BR-E1 (sold separately, 🔗). When you press the remote controller's release (transmit) button, the bulb exposure will start immediately or 2 sec. later. Press the button again to stop the bulb exposure.



## AF, Drive, and Exposure Settings

---

This chapter describes how to configure AF, drive mode, metering mode, and related settings.

### Caution

- < AF > stands for autofocus. < MF > stands for manual focus.

- [AF Operation](#) ☆
- [AF Method](#)
- [Manual Focus](#)
- [Drive Mode](#)
- [Using the Self-Timer](#)
- [Remote Control Shooting](#)
- [Metering Mode](#) ☆
- [Exposure Compensation](#) ☆
- [Exposure Lock \(AE Lock\)](#) ☆

- ☑ [One-Shot AF for Still Subjects](#)
- ☑ [Servo AF for Moving Subjects](#)
- ☑ [AF-assist beam](#)

You can select the AF operation characteristics to suit the shooting conditions or subject. In Basic Zone modes, the optimum AF operation is set automatically for the respective shooting mode.

---

1. Turn the Mode dial to a Creative Zone.
2. Set the focus mode to AF.

- For RF lenses without a focus mode switch

Set [📷: Focus mode] to [AF].

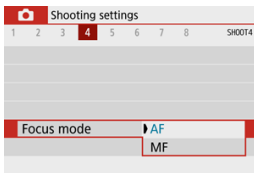

- For RF lenses with a focus mode switch

Set the lens focus mode switch to <AF>.

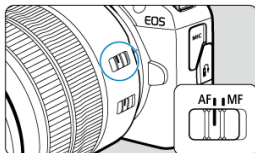

### 3. Select [📷: AF operation].

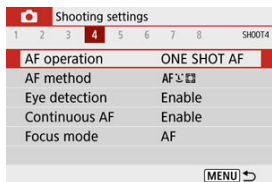

### 4. Select an option.

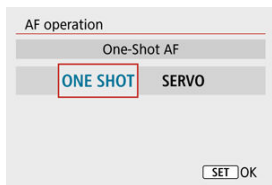

- Press the < ◀ ▶ > keys.

**ONE SHOT:** One-Shot AF

**SERVO:** Servo AF

## One-Shot AF for Still Subjects

This AF operation is suited for still subjects. When you press the shutter button halfway, the camera will focus only once.

- Once a subject is in focus, the focusing AF point turns green and the camera beeps. If focus is not achieved, the AF point will turn orange.
- The focus remains locked while you hold down the shutter button halfway, allowing you to recompose the image before taking the picture.
- For details on the continuous shooting speed for continuous shooting, see [Drive Mode](#).

### Note

- If [**Beep**] is set to [**Disable**], the beeper will not sound when focus is achieved.
- See [Lens Electronic MF](#) when using a lens that supports electronic manual focusing.

## Shooting with the focus locked

In focus lock shooting, you will use One-Shot AF with a fixed AF point, then recompose the shot before shooting. The steps are as follows when you will press the shutter button halfway to focus.

1. Aim the fixed AF point over the subject to focus on, then press the shutter button halfway.

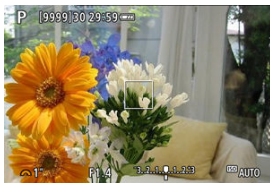

2. After the AF point in focus turns green, keep the shutter button pressed halfway and recompose the shot.



3. Press the shutter button completely to take the picture.

## Servo AF for Moving Subjects

---

This AF operation is suited for moving subjects. While you hold down the shutter button halfway, the camera will keep focusing on the subject continuously.

- Once a subject is in focus, the focusing AF point turns blue. The beeper will not sound even when focus is achieved.
- The exposure is set at the moment the picture is taken.
- For details on the continuous shooting speed for continuous shooting, see [Drive Mode](#).

### Caution

- Depending on the lens used, the distance to the subject and the subject's speed, the camera may not be able to achieve correct focus.
- Zooming during continuous shooting may throw off the focus. Zoom first, then recompose and shoot.

## AF-assist beam

---

The AF-assist beam (📷, 📷) may fire when you press the shutter button halfway under low light or in similar conditions, to make autofocusing easier.

- With a Speedlite, configure the setting on the Speedlite as needed.

### ⚠ Caution

- The flash does not emit an AF-assist beam when AF operation is set to **[Servo AF]**.

### 📷 Note

- To disable AF-assist beam firing, set **[📷: AF-assist beam firing]** to **[Disable]**.

## AF Method

---

- [Selecting the AF Method](#)
- [Eye Detection](#)
- [Magnified View](#)
- [AF Shooting Tips](#)
- [Shooting Conditions That Make Focusing Difficult](#)
- [AF Range](#)

You can select the AF method to suit the shooting conditions or subject. The camera attempts to focus on faces of any people in an AF point or Zone AF frame. In  $\langle \text{AF}^+ \rangle$ ,  $\langle \text{AF} \rangle$ , and  $\langle \text{AF} \rangle$  mode, **[L+Tracking]** is set automatically. For instructions on selecting an AF method, see [Selecting the AF Method](#).

---

### **[L+Tracking]**

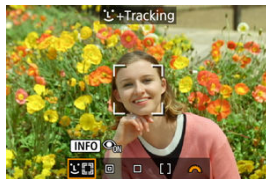

The camera detects and focuses on people's faces. An AF point [ ] appears over any face detected, which is then tracked.  
If no face is detected, the entire AF area is used for focusing.



## Spot AF

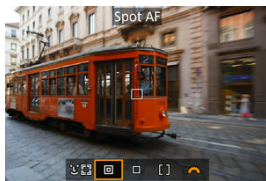

The camera focuses in a narrower area than [1-point AF].

## 1-point AF

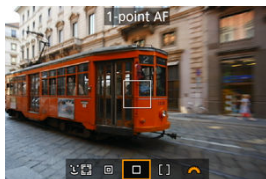

The camera focuses using a single AF point .

## Zone AF

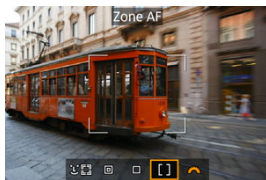

Focuses in a wide Zone AF frame, which makes it easier to acquire subjects than with [1-point AF].

Prioritizes focusing on the nearest subject. Faces of any people in the Zone AF frame are also given priority in focusing.

AF points in focus are displayed with .

## Selecting the AF Method

### 1. Select [CAMERA]: AF method].

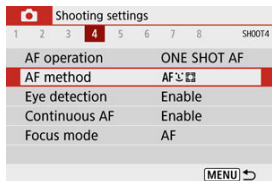

### 2. Select an option.

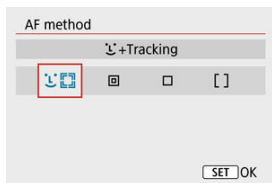



#### Note

- Without using the menu, you can also set the AF method by pressing the < > button and then the < > button again.

## Tracking:



The camera detects and focuses on people's faces. If a face moves, the AF point  also moves to track the face.

With **[Eye detection]** set to **[Enable]**, you can shoot with the subject's eyes in focus ().

\* These instructions apply to the camera with AF operation set to **[One-Shot AF]** (). With **[Servo AF]** () set, the AF point will turn blue when focus is achieved.

### 1. Check the AF point.



- An AF point  appears over any face detected.
- When multiple faces are detected, pressing the  > button changes the AF point to . Press the < ◀ ▶ > keys to select the face to focus on.

## 2. Focus and take the picture.

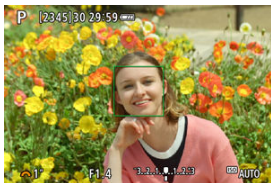
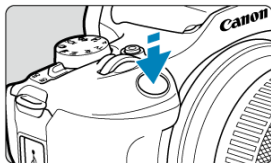

- Once you press the shutter button halfway and the subject is in focus, the AF point turns green and the camera beeps. An orange AF point indicates that the camera could not focus on subjects.

### ⚠ Caution

- If the subject's face is significantly out of focus, face detection will not be possible. Adjust the focus manually (🔍) so that the face can be detected, then perform AF.
- An object other than a human face may be detected as a face.
- Face detection will not work if the face is very small or large in the picture, too bright or too dark, or partially hidden.
- AF cannot detect subjects or people's faces at the edges of the screen. Recompose the shot to center the subject or bring the subject closer to the center.

 **Note**

- The active [ ] may cover only a part of the face, not the whole face.
- The size of the AF point changes depending on the subject.
- An AF point tracks faces or eyes in focus if you have configured the [**Subject to track selection**] setting in Custom Controls in Custom Functions (C.Fn) ( ).  
To activate focusing after an AF point [ ] appears over detected faces or eyes, press the button assigned to [**Subject to track selection**], which will change the AF point to [ ]. Even if faces or eyes move on the screen, the AF point [ ] moves to track them.
- After an AF point [ ] appears over detected faces or eyes, each press of the button assigned to [**Subject to track selection**] switches from one face or eye detected by [ ] to the next until you have cycled through all detected faces or eyes, after which the AF point changes to [ ].

## Spot AF / 1-point AF / Zone AF

You can manually set the AF point or Zone AF frame. Here, 1-point AF screens are used as an example.

### 1. Check the AF point.



- The AF point (1) will appear. With Zone AF, the Zone AF frame is displayed.

### 2. Move the AF point.



- To move the AF point, press the <  > button, then press the < ▲ >> ▼ >> ◀ >> ▶ > keys.
- To center the AF point, press the < MENU > button.

### 3. Focus and take the picture.

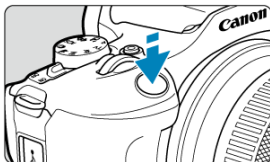

- Aim the AF point over the subject and press the shutter button halfway. When focus is achieved, the AF point will turn green and the beeper will sound. If focus is not achieved, the AF point will turn orange.

#### Caution

- AF points may not track subjects under some shooting conditions when **[Servo AF]** is used with Zone AF.
- Focusing with an AF-assist beam may be difficult with AF points near the edge of the screen. In this case, move to an AF point in the center of the screen.

#### Note

- To return the AF point to the center of the image area, press and hold the  button.

## Eye Detection

With the AF method set to [**L**+Tracking], you can shoot with the subject's eyes in focus.

### 1. Select [**L**: Eye detection].

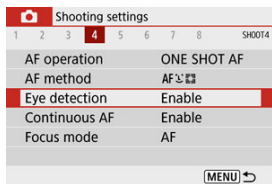

### 2. Select [Enable].

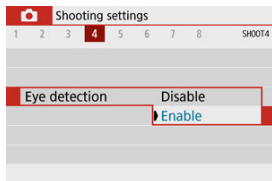



### 3. Aim the camera at the subject.



- An AF point is displayed around their eye.
- If your selected eye is not detected, an eye to focus on is selected automatically.
- You can choose an eye or face to focus on with the < ◀ ▶ > keys when [◀ ▶] is displayed after you press the < [ ] > button, depending on the [Eye detection] setting.

### 4. Take the picture.

#### ⚠ Caution

- Subject eyes may not be detected correctly, depending on the subject and shooting conditions.
- To cancel eye detection, set [📷: Eye detection] to [Disable].

#### 📄 Note

- You can switch the [Eye detection] setting by pressing the < INFO > button when you have set [AF method] to [L+Tracking] on the Quick Control screen after pressing the < [ ] > button.

## Magnified View

To check the focus when the AF method is other than [**L**+Tracking], magnify display by approx. 5× or 10× by pressing the <  > button and then the < INFO > button.

- Magnification is centered on the AF point for [**Spot AF**] or [**1-point AF**] and on the Zone AF frame for [**Zone AF**].
- Autofocusing is performed with magnified display if you press the shutter button halfway when set to [**Spot AF**], and [**1-point AF**]. When set to [**Zone AF**], autofocusing is performed after restoring normal display.
- With Servo AF, if you press the shutter button halfway in the magnified view, the camera will return to the normal view for focusing.

### Caution

- If focusing is difficult in the magnified view, return to the normal view and perform AF.
- If you perform AF in the normal view and then use the magnified view, accurate focus may not be achieved.
- AF speed differs between the normal view and magnified view.
- Continuous AF and Movie Servo AF are not available when display is magnified.
- With the magnified view, achieving focus becomes more difficult due to camera shake. Using a tripod is recommended.

## AF Shooting Tips

---

- Even when focus is achieved, pressing the shutter button halfway will focus again.
- Image brightness may change before and after autofocusing.
- Depending on the subject and shooting conditions, it may take longer to focus, or the continuous shooting speed may decrease.
- If the light source changes as you shoot, the screen may flicker, and focusing may be difficult. In this case, restart the camera and resume shooting with AF under the light source you will use.
- If focusing is not possible with AF, focus manually (☑).
- For subjects at the edge of the screen that are slightly out of focus, try centering the subject (or AF point, or Zone AF frame) to bring them into focus, then recompose the shot before shooting.
- With certain lenses, it may take more time to achieve focus with autofocus, or accurate focusing may not be achieved.

## Shooting Conditions That Make Focusing Difficult

---

- Subject with low-contrast such as the blue sky, solid-color flat surfaces or when highlight or shadow details are clipped.
- Subjects in low light.
- Stripes and other patterns where there is contrast only in the horizontal direction.
- Subjects with repetitive patterns (Example: Skyscraper windows, computer keyboards, etc.).
- Fine lines and subject outlines.
- Under light sources with constantly changing brightness, colors, or patterns.
- Night scenes or points of light.
- The image flickers under fluorescent or LED lighting.
- Extremely small subjects.
- Subjects at the edge of the screen.
- Strongly backlit or reflective subjects (Example: Car with a highly reflective surfaces, etc.).
- Near and distant subjects covered by an AF point (Example: Animal in a cage, etc.).
- Subjects that keep moving within the AF point and will not stay still due to camera shake or subject blur.
- Performing AF when the subject is very far out of focus.
- Soft focus effect is applied with a soft focus lens.
- A special effect filter is used.
- Noise (dots of light, banding, etc.) appears on the screen during AF.

## AF Range

---

The available autofocus range varies depending on the lens used and aspect ratio and whether you are using features such as Movie digital IS.

# Manual Focus

---

If focus cannot be achieved with autofocus, follow the procedure below to focus manually.

## 1. Set the focus mode to <MF>.

- For RF lenses without a focus mode switch

Set [CAMERA: Focus mode] to [MF].

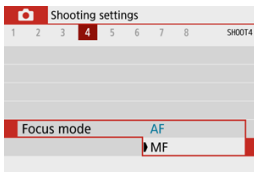

- For RF lenses with a focus mode switch

Set the lens focus mode switch to <MF>.

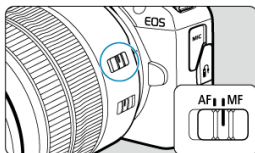

## 2. Magnify the image.



- Pressing the <  > button and then the < INFO > button changes the magnification ratio, as follows.

→ x5 → x10 → x1 →

## 3. Move the magnified area.





- Use the < ▲ > < ▼ > < ◀ > < ▶ > keys to move the magnified area into position for focusing.
- To center the magnified area, press the < MENU > button.

## 4. Focus manually.

- While looking at the magnified image, turn the lens focusing ring to focus.
- After achieving focus, press the <  > button to return to the normal view.

## MF Peaking Settings (Outline Emphasis)

As you shoot, edges of subjects in focus can be displayed in color to make focusing easier. You can set the outline color and adjust the sensitivity (level) of edge detection (except in <  >/<  > modes).

### 1. Select []: MF peaking settings].

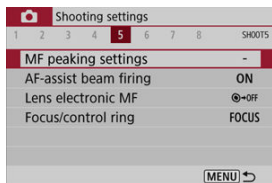

### 2. Select [Peaking].

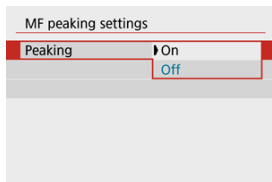

- Select [On].

### 3. Set the level and color.

MF peaking settings	
Peaking	On
Level	High
Color	Red

MENU ↩

- Set it as necessary.

#### Caution

- In magnified view, peaking display is not shown.
- During HDMI output, peaking display is not shown on equipment connected via HDMI.
- MF peaking may be hard to discern at high ISO speeds, especially when ISO expansion is set. If necessary, lower the ISO speed or set **[Peaking]** to **[Off]**.

#### Note

- Peaking display shown on the screen is not recorded in images.



# Drive Mode

## 1. Select [Drive mode].

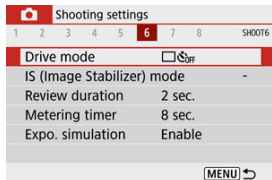

## 2. Select an option.

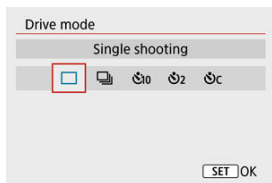

- **[Single shooting]**

When you hold down the shutter button completely, only one shot will be taken.

- **[Continuous shooting]**

When you hold down the shutter button completely, you can shoot continuously at **max. approx. 6.5 shots/sec.** while you keep holding it down. With AF operation set to **[Servo AF]**, the continuous shooting speed will be **max. approx. 3.5 shots/sec.**

- **[Self-timer:10 sec/Remote control]**

- **[Self-timer:2 sec/Remote control]**

- **[Self-timer:Continuous]**

For self-timer shooting, see [Using the Self-Timer](#). For remote control shooting, see [Remote Control Shooting](#).

# Using the Self-Timer

## 1. Select [📷]: Drive mode].

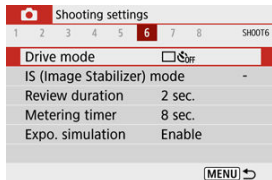

## 2. Select an option.

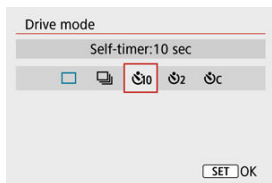

- : **Shoot in 10 sec.**  
Remote control shooting is also possible ().
- : **Shoot in 2 sec.**  
Remote control shooting is also possible ().
- : **Shoot continuously in 10 sec. for the specified number of shots**  
Press the <▲> <▼> keys to set the number of shots to take (2–10).  
Remote control shooting is not possible.
- [] and [] icons are displayed when the camera is paired with a wireless remote control (sold separately, ).

### 3. Take the picture.

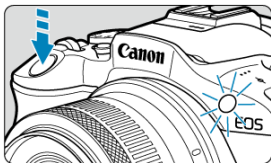

- Focus on the subject, then press the shutter button completely.
- To check operation, look at the self-timer lamp, listen for beeps, or watch the countdown in seconds on the screen.
- The self-timer lamp blinks faster approx. 2 sec. before the shot.

#### ! Caution

- With [C], the shooting interval may become longer under some shooting conditions, depending on image quality, use of flash, and other factors.

#### 📷 Note

- [2] can be used to start shooting without touching the camera and avoid camera shake when it is mounted on a tripod for still-life or long exposure shots.
- After taking self-timer shots, playing back the image (📷) to check focus and exposure is recommended.
- When using the self-timer to shoot yourself, use focus lock (🔒) on an object at the same distance as where you will stand.
- To cancel the self-timer, press the < (📷) > button.
- Auto power off time may be extended when the camera is set for remote control shooting.

## Remote Control Shooting

---

 [Wireless Remote Control BR-E1](#)



 [Remote Switch RS-60E3](#)

Remote shooting is supported with Wireless Remote Control BR-E1 or Remote Switch RS-60E3 (Bluetooth and wired connections, respectively; sold separately).

---

### Wireless Remote Control BR-E1

---

You can shoot remotely up to approx. 5 meters/16.4 feet from the camera. After pairing the camera and BR-E1 () , set the drive mode to [] (). For operating instructions, refer to the BR-E1 instruction manual.



#### Note

- Auto power off time may be extended when the camera is set for remote control shooting.
- BR-E1 can also be used for movie recording ().

## Remote Switch RS-60E3

---

Once connected to the camera, the switch enables you to shoot remotely over a wired connection.

For operating instructions, refer to the RS-60E3 instruction manual.

1. **Open the terminal cover.**
2. **Connect the plug to the remote control terminal.**

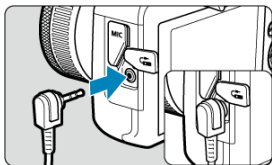



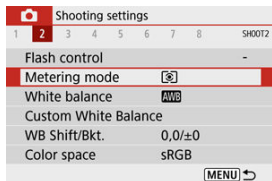

Four methods (metering modes) to measure the subject's brightness are provided. Normally, evaluative metering is recommended. Evaluative metering is set automatically in Basic Zone modes (except in  mode, which uses center-weighted average metering).

## 1. Select : Metering mode].

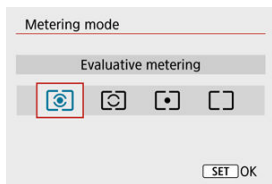

## 2. Select an option.







- : **Evaluative metering**  
General-purpose metering mode suited even for backlit subjects. The camera adjusts the exposure automatically to suit the scene.
- : **Partial metering**  
Effective where there are much brighter lights around the subject due to backlight, etc. Covers approx. 5.8% of the area at the center of the screen. The partial metering area is indicated on the screen.
- : **Spot metering**  
Effective when metering a specific part of the subject. Covers approx. 2.9% of the area at the center of the screen. The spot metering area is indicated on the screen.

- : **Center-weighted average**

The metering across the screen is averaged, with the center of the screen weighted more heavily.

 **Caution**

- With  (evaluative metering), holding down the shutter button halfway when shooting with **[One-Shot AF]** locks the exposure value (AE lock). With  (partial metering),  (spot metering), or  (center-weighted average metering), exposure is set at the moment the picture is taken (without locking the exposure value when the shutter button is pressed halfway).

Exposure compensation can brighten (increased exposure) or darken (decreased exposure) the standard exposure set by the camera.

Exposure compensation is available in <P>, <Tv>, <Av>, and <M> modes. For details on exposure compensation when <M> mode and ISO Auto are both set, see [Exposure Compensation with ISO Auto](#).

## 1. Select the exposure level indicator.

- Press the <▲> key to display the indicator.

## 2. Set the compensation amount.



Decreased exposure, to darken images



Increased exposure, to brighten images

- Set it by looking at the screen as you turn the <☀> dial.
- A [☒] icon is displayed to indicate exposure compensation.

## 3. Take the picture.

- To cancel exposure compensation, return the exposure level indicator [☒] to [0], the standard exposure index.



### ! Caution

- If [☑: Auto Lighting Optimizer] (☑) is set to any setting other than [Disable], the image may still look bright even if decreased exposure compensation is set to darken images.





## Note

- The exposure compensation amount will remain in effect even after you turn off the camera.
- Can also be set on the shooting functions screen, in [: **Exposure comp./AEB setting**] ().

You can lock the exposure when you want to set the focus and exposure separately or when you will take multiple shots at the same exposure setting. Press the < \* > button to lock the exposure, then recompose and take the picture. It is effective for shooting backlit subjects, etc.

### 1. Focus on the subject.

- Press the shutter button halfway.

### 2. Press the < \* > button.

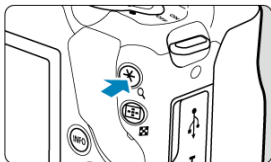

- [ \* ] is displayed on the screen to indicate that exposure is locked (AE lock). To cancel AE lock, press the < \* > button again.



### 3. Recompose and take the picture.

- Press the shutter button.

#### ⚠ Caution

- If [📷: Auto Lighting Optimizer] (🔒) is set to any setting other than [Disable], the image may still look bright even if decreased exposure compensation is set to darken images.

## AE Lock Effects

Metering Mode (☑)	AF Point Selection (☑)	
	Automatic Selection	Manual Selection
	Exposure centered on the AF point in focus is locked.	Exposure centered on the selected AF point is locked.
	AE lock is applied at the center AF point.	

\* Center-weighted exposure is locked when  is set with the camera configured for manual focusing (☑).

### Note

- AE lock is not possible with bulb exposures.

# Flash Photography

---

This chapter describes how to shoot with the built-in flash or an external flash (EL/EX series Speedlites).

- ☆ to the right of page titles indicates functions only available in Creative Zone modes (<P>, <Tv>, <Av>, or <M>).

## Caution

- Flash cannot be used while you are recording movies.
- AEB is not available in flash photography.

- [Shooting with the Built-in Flash](#)
- [Flash Function Settings](#)
- [Shooting with Speedlites](#)☆

## Shooting with the Built-in Flash

---

### [Shooting with FE Lock](#)☆

Using the built-in flash is recommended when the  icon appears in the viewfinder or on the screen, when subjects in daytime shots are backlit, or when shooting under low light.

---

#### 1. Manually raise the flash.

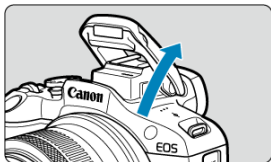

- In Creative Zone modes, shooting with flash is possible whenever the flash is raised.
- [BUSY] is displayed on the screen while the flash is charging.

#### 2. Press the shutter button halfway.

- Confirm that  appears on the screen.

#### 3. Take the picture.

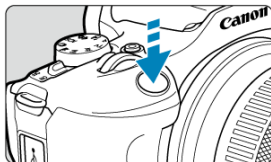

- When focus is achieved and you press the shutter button completely, the flash will fire at all times.
- To retract the built-in flash after shooting, push it down with your fingers until it clicks into place.

## Shooting tips

- **In bright light, decrease the ISO speed.**

If the exposure setting in the viewfinder blinks, decrease the ISO speed.

- **Detach the lens hood. Do not get too close to the subject.**

If the lens has a hood attached or you are too close to the subject, the bottom of the picture may look dark due to the obstructed flash light. For important shots, play back the image and check to make sure the picture does not look unnaturally dark at the bottom part.

### Caution

- Do not use the built-in flash unless it is fully raised.

### Note

- If the bottom of images is dark when you use super telephoto or large-diameter lenses, consider using an external Speedlite (sold separately, ) .

## Shooting with FE Lock

The background or other factors may make subjects brighter or darker in flash photography with subjects near the edge of the screen. In this case, use FE lock. After setting the flash output for the appropriate subject brightness, you can recompose (put the subject toward the side) and shoot. This feature can also be used with a Canon EL/EX series Speedlite.

\* FE stands for Flash Exposure.

### 1. Manually raise the flash.

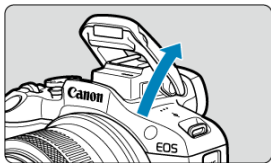

- Press the shutter button halfway and confirm that  appears on the screen.

2. Focus on the subject.

3. Press the < \* > button (⊙16).



- Center the subject in the viewfinder, then press the < \* > button.
- A preflash is fired by the flash, and the flash output required for shooting is retained.



- [ \* ] appears on the screen.
- Each time you press the < \* > button, a preflash is fired, and the flash output required for shooting is retained.

4. Take the picture.

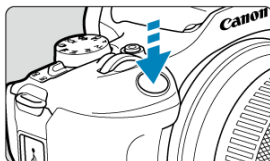

- Compose the shot and press the shutter button completely.

 Caution

- The [⚡] icon blinks when subjects are too far away and your shots would be dark. Approach the subject and repeat steps 2–4.



# Flash Function Settings

---

- [Flash Firing](#)
- [E-TTL II Flash Metering](#)☆
- [Red-Eye Reduction](#)
- [Slow Synchro](#)☆
- [Built-in Flash Function Settings](#)☆
- [External Flash Function Settings](#)☆
- [External Flash Custom Function Settings](#)☆
- [Clearing Flash Function Settings/C.Fn Settings](#)☆

Functions of the built-in flash or external EL/EX series Speedlites can be set from menu screens on the camera.

Before setting functions of external Speedlites, attach the Speedlite and turn it on.

For details on external Speedlite functions, refer to the Speedlite's instruction manual.

---

## 1. Select [Flash control].

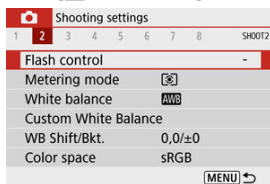

## 2. Select an option.

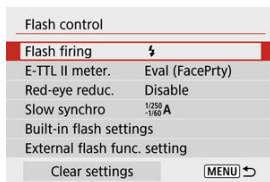

## Flash Firing



- Set to [⚡<sup>A</sup>] (in Basic Zone or <P> modes) to have the flash fire automatically, based on shooting conditions.
- Set to [⚡] to have the flash always fire when you shoot.
- Select [⚡/] (in Creative Zone modes) to keep the flash off, or if you will use the AF-assist beam.

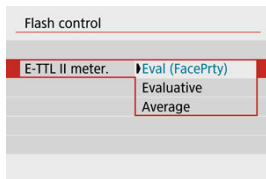

- Set to **[Eval (FacePrty)]** for flash metering suitable for shots of people.
- Set to **[Evaluative]** for flash metering that emphasizes firing in continuous shooting.
- If **[Average]** is set, the flash exposure will be averaged for the entire metered scene.

### ⚠ Caution

- Even when **[Eval (FacePrty)]** is set, some subjects and shooting conditions may prevent you from obtaining the expected result.

## Red-Eye Reduction

---

Set to **[Enable]** to reduce red-eye by firing the red-eye reduction lamp before firing the flash.

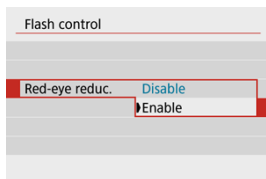

You can set the flash-sync speed for flash photography in <Av> and <P> modes.

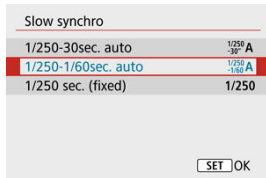

- **[ $\frac{1}{250}$   
-30<sup>o</sup>] 1/250-30sec. auto**  
The flash sync speed is set automatically within a range of 1/250 sec. to 30 sec. to suit the scene's brightness. Slow-synch shooting is used in low-light locations (under some shooting conditions), and shutter speed is automatically lowered.
- **[ $\frac{1}{250}$   
-1/60] 1/250-1/60sec. auto**  
Prevents a slow shutter speed from being set automatically in low-light conditions. It is effective for preventing subject blur and camera shake. Light from the flash provides standard exposure for subjects, but note that backgrounds may be dark.
- **[1/250] 1/250 sec. (fixed)**  
The shutter speed is fixed at 1/250 sec., which is more effective in preventing subject blur and camera shake than with **[1/250-1/60sec. auto]**. However, in low light, the subject's background will come out darker than with **[1/250-1/60sec. auto]**.

### Caution

- To use slow-synch shooting in <Av>/<P> mode, set to **[1/250-30sec. auto]**.

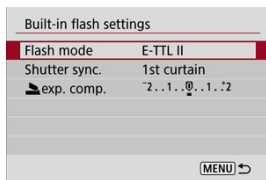

### Flash mode

Set to **[E-TTL II]** to shoot in E-TTL II/E-TTL fully automatic flash mode.

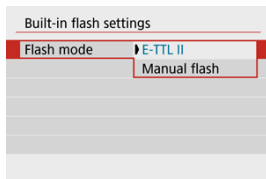

Set to **[Manual flash]** to specify your preferred flash output in **[flash output]**.

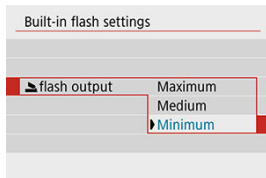

- Only available in <Tv>/<Av>/<M> mode.

## Shutter sync.

Normally, set to **[1st curtain]** so that the flash fires immediately after shooting starts. Set to **[2nd curtain]** and use low shutter speeds for natural-looking shots of subject motion trails, such as car headlights.

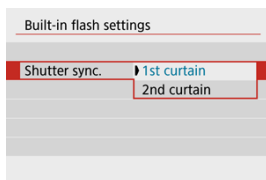

### ⚠ Caution

- When shooting with **[2nd curtain]**, set a shutter speed of 1/60 sec. or slower. For shutter speeds exceeding 1/60 sec., first-curtain synchronization is used automatically even if **[2nd curtain]** is set.



## exp. comp. ☆

Set the flash exposure compensation if the brightness of the subject does not come out as desired (so you want to adjust the flash output) in flash photography. You can set the flash exposure compensation up to  $\pm 2$  stops in 1/3-stop increments.

### 1. Select [exp. comp.].

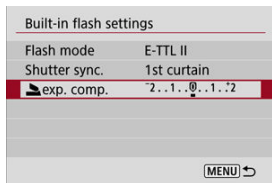

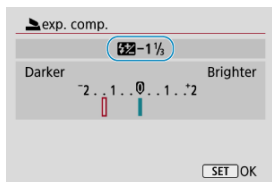

### 2. Set the compensation amount.



- If the exposure is too dark, press the < ► > key (for increased exposure).
- If the exposure is too bright, press the < ◀ > key (for decreased exposure).
- After taking the picture, cancel the flash exposure compensation by setting it back to 0.

 **Caution**

- Setting [: **Auto Lighting Optimizer**] () to an option other than [**Disable**] may still cause images to look bright even if you set negative flash exposure compensation for darker exposure.
- If flash exposure compensation is set with a Speedlite (sold separately, ) , you cannot set the flash exposure compensation with the camera (Quick Control or external flash function setting). Note that the Speedlite's setting overrides the camera's if both are set at the same time.

 **Note**

- The exposure compensation amount will remain in effect even after you set the power switch to < **OFF** >.

The information displayed on the screen, position of display, and available options vary depending on the Speedlite model, its Custom Function settings, the flash mode, and other factors. Refer to the instruction manual of your flash unit for details on its functions.

### Sample display

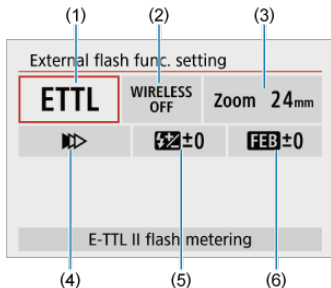

- (1) Flash mode
- (2) Wireless functions/Firing ratio control
- (3) Flash zoom (flash coverage)
- (4) Shutter synchronization
- (5) Flash exposure compensation
- (6) Flash exposure bracketing

### Caution

- Functions are limited when using EX series Speedlites that are not compatible with flash function settings.

## Flash mode

You can select the flash mode to suit your desired flash photography.

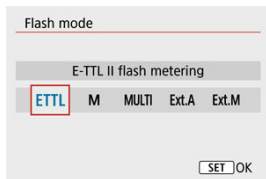

- **[E-TTL II]** is the standard mode of EL/EX-series Speedlites that support autoexposure flash photography.
- **[Manual flash]** is a mode for manually configuring the Speedlite's **[Flash output]** setting.
- **[CSP]** (Continuous shooting priority mode) is available when using a compatible Speedlite. This mode automatically reduces flash output by one stop and increases ISO speed by one stop. Useful in continuous shooting, and helps conserve flash battery power.
- Regarding other flash modes, refer to the Instruction Manual of a Speedlite compatible with the respective flash mode.

### Caution

- Adjust [Exposure Compensation](#) as needed in case of overexposure from flash photography with **[CSP]** in <Tv> or <M> mode.

### Note

- With **[CSP]**, ISO speed is automatically set to **[Auto]**.

## Wireless functions

You can use radio or optical wireless transmission to shoot with wireless multiple-flash lighting.

For details on wireless flash, refer to the Instruction Manual of a Speedlite compatible with wireless flash photography.

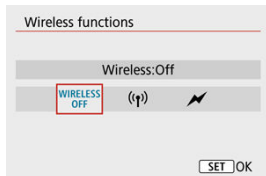

## Firing ratio control

With a macro flash, you can set the firing ratio control.

For details on firing ratio control, refer to the Instruction Manual of the macro flash.



## Flash zoom (flash coverage)

With Speedlites having a zooming flash head, you can set the flash coverage.

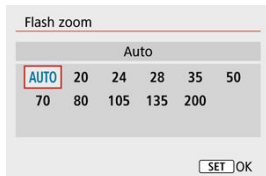

## Shutter synchronization

Normally, set this to **[First-curtain synchronization]** so that the flash fires immediately after the shooting starts. Set to **[Second-curtain synchronization]** and use low shutter speeds for natural-looking shots of subject motion trails, such as car headlights.

Set to **[High-speed synchronization]** for flash photography at higher shutter speeds than the maximum flash sync shutter speed. This is effective when shooting with an open aperture in **<Av>** mode to blur the background behind subjects outdoors in daylight, for example.

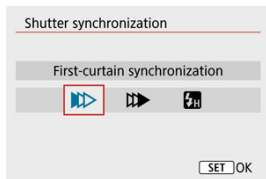

### Caution

- When shooting with **[Second-curtain synchronization]**, set a shutter speed of 1/60 sec. or slower. For shutter speeds exceeding 1/60 sec., first-curtain synchronization is applied automatically even if **[Second-curtain synchronization]** is set.

## Flash exposure compensation

Just as exposure compensation is adjustable, you can also adjust flash output of external Speedlites.

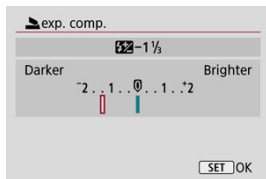

### Caution

- If flash exposure compensation is set with the Speedlite, you cannot set the flash exposure compensation with the camera. Note that the Speedlite's setting overrides the camera's if both are set at the same time.

## Flash exposure bracketing

Speedlites equipped with flash exposure bracketing (FEB) can change the external flash output automatically as three shots are taken at once.

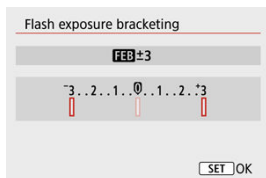

For details on the external Speedlite's Custom Functions, refer to the Speedlite's Instruction Manual.

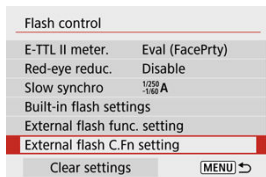

### ⚠ Caution

- With an EL/EX series Speedlite, the Speedlite will always fire at full output if the **[Flash metering mode]** Custom Function is set to **[1:TTL]** (autoflash).
- Setting or clearing Speedlite Personal Functions (P.Fn) is not possible from the camera's **[📷: External flash func. setting]** screen. Set them directly from the Speedlite.



## 1. Select [Clear settings].

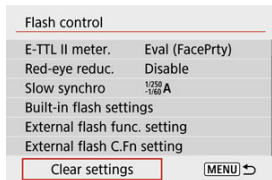

## 2. Select the settings to be cleared.

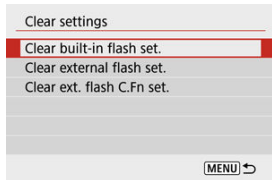

- Select [**Clear built-in flash set.**], [**Clear external flash set.**], or [**Clear ext. flash C.Fn set.**].
- Select [**OK**] on the confirmation screen to clear all flash settings or Custom Function settings.

- ☑ [EL/EX Series Speedlites for EOS Cameras](#)
- ☑ [Canon Speedlites Other Than the EL/EX Series](#)
- ☑ [Non-Canon Flash Units](#)

## EL/EX Series Speedlites for EOS Cameras

The camera supports flash photography using all functions of EL/EX series Speedlites (sold separately).

For instructions, refer to the EL/EX series Speedlite's Instruction Manual.

### ⚠ Caution

- Speedlites will not fire intermittently to provide an AF-assist beam.

## Canon Speedlites Other Than the EL/EX Series

- With an EZ/E/EG/ML/TL series Speedlite set to A-TTL or TTL autoflash mode, the flash can be fired at full output only.  
Set the camera's shooting mode to <M> or <Av> and adjust the aperture value before shooting.
- When using a Speedlite that has manual flash mode, shoot in the manual flash mode.

### Sync speed

The camera can synchronize with non-Canon compact flash units at up to 1/250 sec. With large studio flash units, the flash duration is longer than that of a compact flash unit and varies depending on the model. Before shooting, confirm that flash sync is performed correctly by taking some test shots at a sync speed of approx. 1/60 sec. to 1/30 sec.

#### Caution

- Manually lower the built-in flash before attaching an external flash unit.
- Using the camera with a dedicated flash unit or flash accessory for cameras of other manufacturers poses a risk of malfunction and even damage.
- Do not attach a high-voltage flash unit to the camera's hot shoe. It may not fire.

## Shooting and Recording

---

This chapter describes shooting and recording and introduces menu settings on the shooting () tab.

- [Still Photo Shooting](#)
- [Movie Recording](#)

## Still Photo Shooting

---

☆ to the right of page titles indicates functions only available in Creative Zone modes.

- [Tab Menus: Still Photo Shooting](#)
- [Image Quality](#)
- [Still Image Aspect Ratio](#)
- [Exposure Compensation/AEB Settings](#)☆
- [ISO Speed Settings for Still Photos](#)☆
- [Auto Lighting Optimizer](#)☆
- [Highlight Tone Priority](#)☆
- [White Balance Settings](#)☆
- [White Balance Correction](#)☆
- [Color Space](#)☆
- [Picture Style Selection](#)☆
- [Picture Style Customization](#)☆
- [Picture Style Registration](#)☆
- [Lens Aberration Correction](#)☆
- [Noise Reduction Features](#)☆
- [Appending Dust Delete Data](#)☆
- [Continuous AF](#)
- [Focus Mode](#)☆
- [AF-Assist Beam Firing](#)
- [Lens Electronic MF](#)☆
- [Focus/Control Ring](#)☆
- [Image Stabilizer \(IS Mode\)](#)
- [Review Duration](#)
- [Metering Timer](#)☆
- [Exposure Simulation](#)☆
- [Shooting Information Display](#)
- [Viewfinder Display Format](#)

- [Display Performance](#)
- [General Still Photo Shooting Precautions](#)

# Tab Menus: Still Photo Shooting

## ● Shooting 1

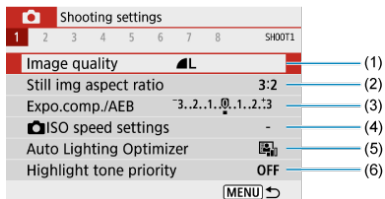

- (1) [Image quality](#)
- (2) [Still img aspect ratio](#)
- (3) [Expo.comp./AEB](#)☆
- (4) [ISO speed settings](#)☆
- (5) [Auto Lighting Optimizer](#)☆
- (6) [Highlight tone priority](#)☆

## ● Shooting 2

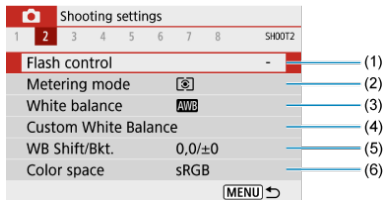

- (1) [Flash control](#)
- (2) [Metering mode](#)☆
- (3) [White balance](#)☆
- (4) [Custom White Balance](#)☆
- (5) [WB Shift/Bkt.](#)☆
- (6) [Color space](#)☆

## ● Shooting 3

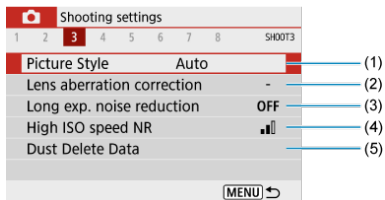

(1) [Picture Style](#)☆

[Picture Style Selection](#)☆

[Picture Style Customization](#)☆

[Picture Style Registration](#)☆

(2) [Lens aberration correction](#)☆

(3) [Long exp. noise reduction](#)☆

(4) [High ISO speed NR](#)☆

(5) [Dust Delete Data](#)☆

## ● Shooting 4

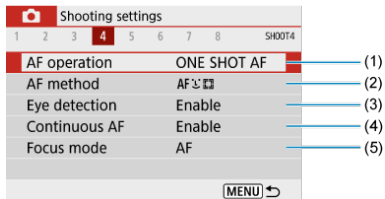

(1) [AF operation](#)☆

(2) [AF method](#)

(3) [Eye detection](#)

(4) [Continuous AF](#)

(5) [Focus mode](#)☆



## ● Shooting 5

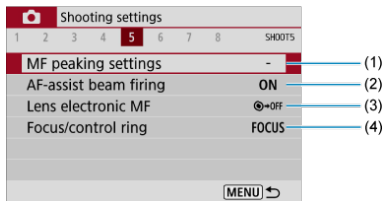

- (1) [MF peaking settings](#)
- (2) [AF-assist beam firing](#)
- (3) [Lens electronic MF](#)☆
- (4) [Focus/control ring](#)☆

## ● Shooting 6

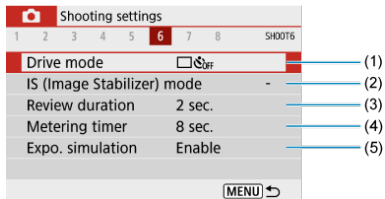

- (1) [Drive mode](#)
- (2) [IS \(Image Stabilizer\) mode](#)
- (3) [Review duration](#)
- (4) [Metering timer](#)☆
- (5) [Expo. simulation](#)☆

## ● Shooting 7

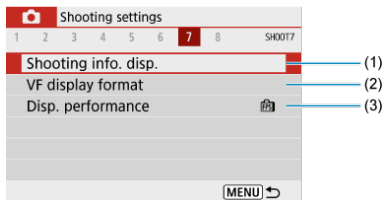

- (1) [Shooting info. disp.](#)
- (2) [VF display format](#)
- (3) [Disp. performance](#)

## ● Shooting 8

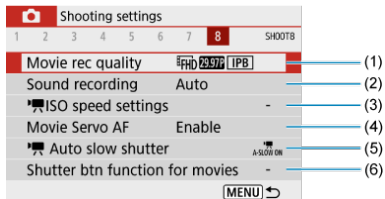

- (1) [Movie rec quality](#)
- (2) [Sound recording](#)
- (3) [ISO speed settings](#)☆
- (4) [Movie Servo AF](#)
- (5) [Auto slow shutter](#)
- (6) [Shutter btn function for movies](#)

**In Basic Zone modes, the following screens are displayed. Note that available setting items vary by shooting mode.**

## ● Shooting 1

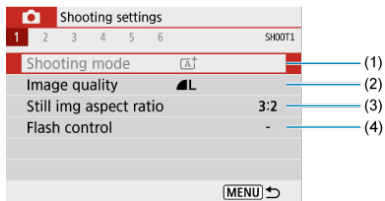

- (1) [Shooting mode](#)
- (2) [Image quality](#)
- (3) [Still img aspect ratio](#)
- (4) [Flash control](#)

## ● Shooting 2

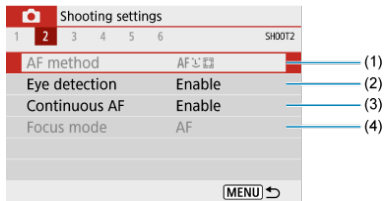

- (1) [AF method](#)
- (2) [Eye detection](#)
- (3) [Continuous AF](#)
- (4) [Focus mode](#)

### ● Shooting 3

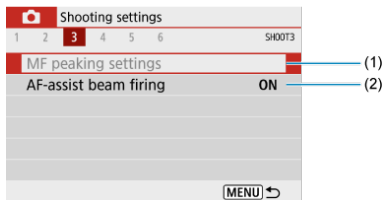

- (1) [MF peaking settings](#)
- (2) [AF-assist beam firing](#)

### ● Shooting 4

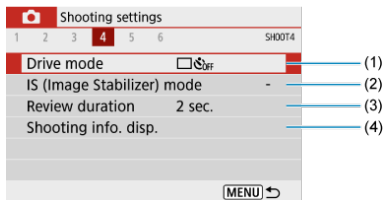

- (1) [Drive mode](#)
- (2) [IS \(Image Stabilizer\) mode](#)
- (3) [Review duration](#)
- (4) [Shooting info. disp.](#)

## ● Shooting 5

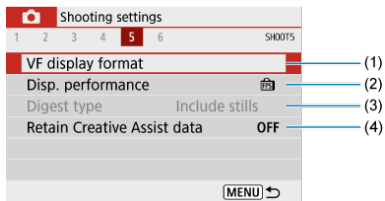

- (1) [VF display format](#)
- (2) [Disp. performance](#)
- (3) [Digest type](#)
- (4) [Retain Creative Assist data](#)

## ● Shooting 6

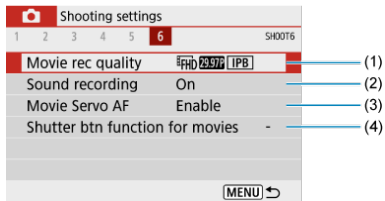

- (1) [Movie rec quality](#)
- (2) [Sound recording](#)
- (3) [Movie Servo AF](#)
- (4) [Shutter btn function for movies](#)

# Image Quality

- ☑ [RAW Images](#)
- ☑ [Guide to Image Quality Settings](#)
- ☑ [Maximum Burst for Continuous Shooting](#)

## 1. Select [📷: Image quality].

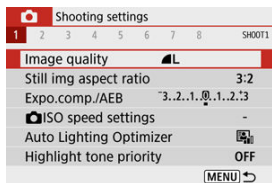

## 2. Set the image quality.

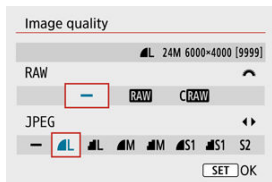











- For RAW images, turn the <🌞> dial, and for JPEGs, press the <◀>>▶> keys.
- Press the <📷> button to set it.



### ⚠ Caution

- Number of shots available as indicated by [\*\*\*\*] on the image quality setting screen always applies to a setting of [3:2], regardless of the actual aspect ratio setting (📷).

#### Note

- If [-] is set for both the RAW image and JPEG image,  will be set.
- If you select both RAW and JPEG, each time you shoot, the image will be recorded simultaneously to the card as both a RAW and JPEG image at your specified image qualities. The two images will be recorded with the same file numbers (file extension: .JPG for JPEG and .CR3 for RAW).
- **S2** is in  (Fine) quality.
- Meaning of image quality icons:  RAW,  Compact RAW,  JPEG,  Fine,  Normal,  Large,  Medium,  Small.

## RAW Images

RAW images are raw data from the image sensor that are recorded to the card digitally as  or  (smaller than ) files, depending on your selection. You can use Digital Photo Professional (EOS software) to process RAW images. You can make various adjustments to images depending upon how they will be used and can generate JPEG or other types of images reflecting the effects of those adjustments.

#### Caution

- To display RAW images on a computer, using Digital Photo Professional (EOS software, hereafter DPP) is recommended.
- Older versions of DPP Ver. 4.x do not support display, processing, editing, or other operations with RAW images captured by this camera. If a previous version of DPP Ver. 4.x is installed on your computer, obtain and install the latest version of DPP from the Canon website to update it () , which will overwrite the previous version. Similarly, DPP Ver. 3.x or earlier does not support display, processing, editing, or other operations with RAW images captured by this camera.
- Commercially available software may not be able to display RAW images captured by this camera. For compatibility information, contact the software manufacturer.

## Guide to Image Quality Settings

For details on file size, number of shots available, maximum burst, and other estimated values, see [File size/number of shots available](#) and [Maximum burst \(approx. shots\)](#).

### Maximum Burst for Continuous Shooting



The estimated maximum burst is shown on the top of the shooting screen.

#### Note

- When the maximum burst in still photo shooting is indicated as "99," you can shoot 99 shots or more continuously. Fewer shots are available for a value of 98 or lower, and when **[BUSY]** is displayed on the shooting screen, internal memory is full and shooting will stop temporarily. If you stop continuous shooting, the maximum burst will increase. After all captured images have been written to a card, you can once again shoot at the maximum burst listed in [Maximum burst \(approx. shots\)](#).



# Still Image Aspect Ratio

---

You can change the image's aspect ratio.

---

## 1. Select [CAMERA]: Still img aspect ratio].

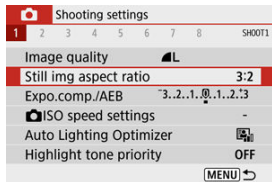

## 2. Set the aspect ratio.

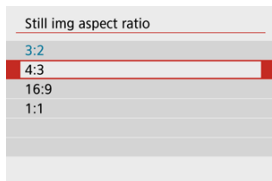

- Select an aspect ratio, then press the < [MENU] > button.

### ● JPEG images

The images will be recorded with the set aspect ratio.

### ● RAW Images

The images will always be recorded in the [3:2] aspect ratio. The selected aspect ratio information is added to the RAW image file, which enables Digital Photo Professional (EOS software) to generate an image with the same aspect ratio as set at the time of shooting when you process RAW images with this software.

Aspect Ratio		
4:3	16:9	1:1
		

 **Note**

- RAW images shot at an aspect ratio of [4:3], [16:9], or [1:1] are displayed during playback with lines indicating the respective aspect ratio, but these lines are not recorded in the image.

You can capture three images at different shutter speeds, aperture values, and ISO speeds, as adjusted by the camera. This is called AEB.



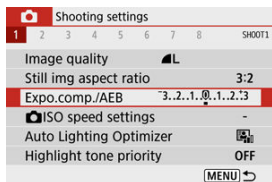

\* AEB stands for Auto Exposure Bracketing.

## 1. Select [📷: Expo.comp./AEB].

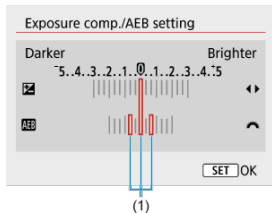

## 2. Set the AEB range.



- Turn the  dial to set the AEB range (1). By using the  < >  keys, you can set the amount of exposure compensation.
- Press  to set it.
- Once an AEB range is set, it is shown on the screen on the exposure level indicator.

### 3. Take the picture.



Standard exposure



Decreased exposure



Increased exposure

- Three bracketed shots are taken, according to the specified drive mode, in this sequence: Standard exposure, decreased exposure, and increased exposure.
- AEB will not be automatically canceled. To cancel AEB, follow step 2 to turn off the AEB range display.

#### Caution

- Exposure compensation in AEB may be less effective with **[Auto Lighting Optimizer]** (☑) set to an option other than **[Disable]**.

#### Note

- If the drive mode is set to **[□]**, press the shutter button three times for each shot. In **[□]** mode, holding down the shutter button completely captures three images, one after another, before the camera automatically stops shooting. When **[10]** or **[2]** is set, three consecutive shots are captured after a delay of 10 or 2 sec. When set to **[C]**, three times the specified number of shots are taken in continuous shooting.
- You can set AEB in combination with exposure compensation.
- AEB is not available with flash, Multi Shot Noise Reduction, Creative filter, or bulb shooting.
- AEB will be canceled automatically if you do any of the following: Setting the power switch to **<OFF>** or when the flash is fully charged.

Set the ISO speed (image sensor's sensitivity to light) to suit the ambient light level. In Basic Zone modes, ISO speed is set automatically.

For details on ISO speed in movie recording, see [ISO Speed in Movie Recording](#).

1. Press the < ◀ ▶ > key.

2. Set the ISO speed.

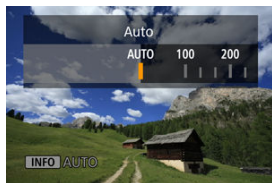

- Set by pressing the < ◀ ▶ > keys.
- ISO speed can be set within ISO 100–12800 in 1/3-stop increments.
- With [AUTO] selected, ISO speed is set automatically. You can also press the < INFO > button to set the speed to [AUTO].
- When [AUTO] is selected, pressing the shutter button halfway will display the ISO speed actually set.

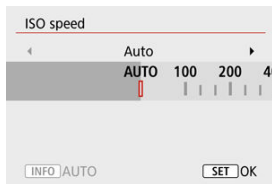

- To specify [AUTO] when setting [ISO speed] in [📷: 📷 ISO speed settings] (shown above), press the < INFO > button.

## ISO speed guide

- Low ISO speeds reduce image noise but may increase the risk of camera/subject shake or reduce the area in focus (shallower depth of field), in some shooting conditions.
- High ISO speeds enable low-light shooting, a larger area in focus (deeper depth of field), and longer flash range but may increase image noise.

### Note

- Can also be set on the **[ISO speed]** screen in **[ISO speed settings]**.
- To add **[H]** (equivalent to ISO 25600) as an available option, set **[ISO expansion]** to **[1:Enable]** in **[Custom Functions(C.Fn)]** .

### Caution

- Setting **[Highlight tone priority]** to **[Enable]** or **[Enhanced]** will prevent you from selecting ISO 100/125/160 or **[H]** (equivalent to ISO 25600) .
- Shooting in high temperatures may result in images that look grainier. Long exposures may also cause irregular colors in the image.
- Image noise (such as dots of light or banding) or irregular colors may be noticeable at high ISO speeds.
- Overexposure may occur with subjects captured at close range at high ISO speeds.
- When shooting in conditions that produce an extreme amount of noise, such as a combination of high ISO speed, high temperature, and long exposure, images may not be recorded properly.
- Image noise (such as dots of light or banding) and irregular colors may increase and apparent resolution may decrease at **H** (equivalent to ISO 25600), which is an expanded ISO speed.

## Maximum [AUTO] ISO Speed

For ISO Auto, you can set the maximum ISO speed limit within ISO 400–12800.

### 1. Select [CAMERA: CAMERA] ISO speed settings.

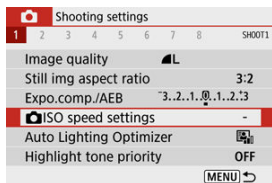

### 2. Select [Max for Auto].

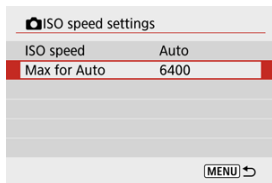

- Select [Max for Auto], then press the < [SET] > button.

### 3. Select the ISO speed.

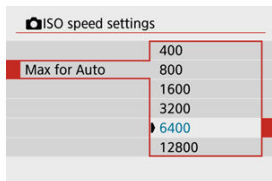

- Select an ISO speed, then press the < [SET] > button.

Brightness and contrast can be corrected automatically if shots look dark or contrast is too low or high.

## 1. Select [📷: Auto Lighting Optimizer].

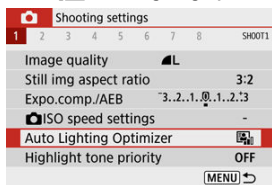

## 2. Set a correction option.

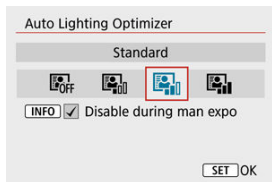

### ⚠ Caution

- Noise may increase and apparent resolution may change, under some shooting conditions.
- If the effect of Auto Lighting Optimizer is too strong and results are not at your preferred brightness, set to [Low] or [Disable].
- If a setting other than [Disable] is set and you use exposure compensation or flash exposure compensation to darken the exposure, the image may still come out bright. If you want a darker exposure, set this function to [Disable].
- Maximum burst is lower with [High]. Image recording to the card also takes longer.





#### Note

- To enable **[📷: Auto Lighting Optimizer]** to be set even in **<M>** mode, press the **<INFO>** button in step 2 to clear the checkmark **[✓]** for **[Disable during man expo]**.

You can reduce overexposed, clipped highlights.

## 1. Select [📷: Highlight tone priority].

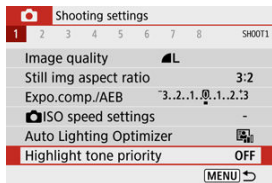

## 2. Set an option.

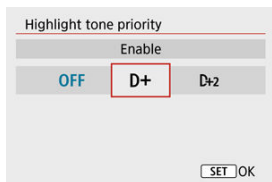

- **[Enable]**: Improves gradation in highlights. The gradation between the grays and highlights becomes smoother.
- **[Enhanced]**: Reduces overexposed highlights even more than **[Enable]**, under some shooting conditions.

### ⚠ Caution

- Noise may increase slightly.
- The available ISO range starts at ISO 200. Expanded ISO speeds cannot be set.
- **[Enhanced]** is not available when recording movies.
- With **[Enhanced]**, results in some scenes may not look as expected.

- ☑ [White Balance](#)
- ☑ [\[AWB\] Auto White Balance](#)
- ☑ [\[K\] Custom White Balance](#)
- ☑ [\[K\] Color Temperature](#)

White balance (WB) is for making the white areas look white. Normally, the Auto [AWB] (Ambience priority) or [AWBW] (White priority) setting will obtain the correct white balance. If natural-looking colors cannot be obtained with Auto, you can select the white balance to match the light source or set it manually by shooting a white object.



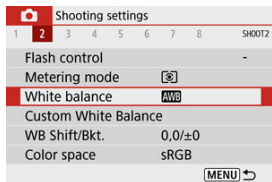



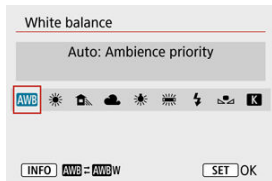



## 1. Select [📷: White balance].



## 2. Select an option.



(Approx.)

Display	Mode	Color Temperature (K: Kelvin)
	<a href="#">Auto: Ambience priority</a>	3000–7000
	<a href="#">Auto: White priority</a>	
	Daylight	5200
	Shade	7000
	Cloudy, twilight, sunset	6000
	Tungsten light	3200
	White fluorescent light	4000
	Flash	Automatically set*
	<a href="#">Custom</a>	2000–10000
	<a href="#">Color temp.</a>	2500–10000

\* Applicable with Speedlites having a color temperature transmission function. Otherwise, it will be fixed to approx. 6000K.

## White Balance

The human eye adapts to changes in lighting so that white objects look white under all kinds of lighting. Digital cameras determine white from the color temperature of lighting and, based on this, apply image processing to make color tones look natural in your shots.

## [AWB] Auto White Balance

With [AWB], you can slightly increase the intensity of the image's warm color cast when shooting a tungsten-light scene.

If you select [AWBW], you can reduce the intensity of the image's warm color cast.

### 1. Select [📷: White balance].

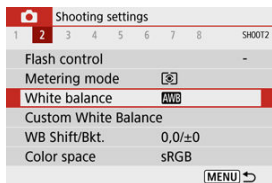

### 2. Select [AWB].

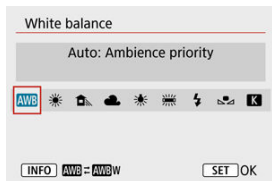

- With [AWB] selected, press the <INFO> button.

### 3. Select an option.

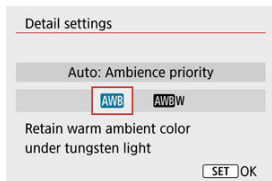

 Caution

**Precautions when set to [AWBW]**

- The warm color cast of subjects may appear faded.
- When multiple light sources are included in the scene, the warm color cast of the picture may not be reduced.
- When using flash, the color tone will be the same as with [AWB].

## [MENU] Custom White Balance

With custom white balance, you can manually set the white balance for the specific light source of the shooting location. Make sure to perform this procedure under the light source at the actual location of the shoot.

### 1. Shoot a white object.

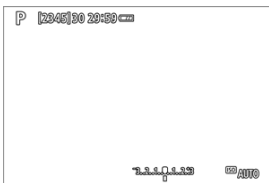

- Aim the camera at a plain white object, so that white fills the screen.
- Focus manually and shoot with the standard exposure set for the white object.
- You can use any of the white balance settings.

### 2. Select [WB]: Custom White Balance.

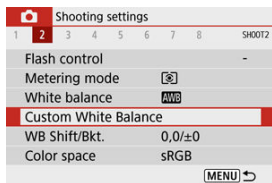

### 3. Import the white balance data.

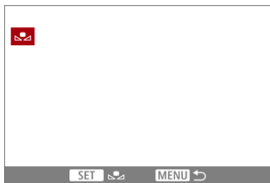

- Use the <◀>>▶> keys to select the image captured in step 1, then press the <Ⓜ> button. Select [OK] to import the data.

### 4. Select [📷: White balance].

### 5. Select [📷].

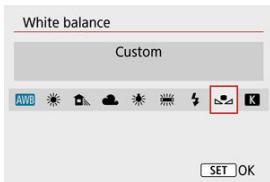

#### ! Caution

- If the exposure obtained in step 1 differs greatly from the standard exposure, a correct white balance may not be obtained.
- These images cannot be selected: Images captured with Picture Style set to **[Monochrome]**, images with a Creative filter applied before or after shooting, cropped images, or images shot with another camera.
- Images that cannot be used in the setting may be displayed.



**Note**

- Instead of shooting a white object, you can also shoot a gray card or standard 18% gray reflector (commercially available).

### 1. Select [K]: White balance.

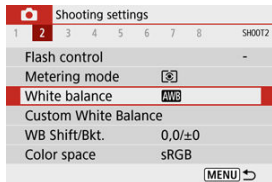

### 2. Set the color temperature.

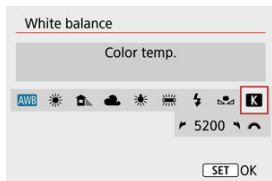

- Select [K].
- Turn the < sun > dial to set your preferred color temperature, then press the < [K] > button.
- The color temperature can be set from approx. 2500K to 10000K in 100K increments.

#### ! Caution

- When setting the color temperature for an artificial light source, set the white balance correction (magenta or green bias) as necessary.
- When setting [K] to a value measured with a commercially available color temperature meter, take some test shots in advance and adjust the setting as needed to compensate for any difference between the color temperature meter and the camera.

[White Balance Correction](#)

[White Balance Auto Bracketing](#)

White balance correction has the same effect as using a commercially available color temperature conversion filter or color compensating filter.

## White Balance Correction

### 1. Select [CAMERA]: WB Shift/Bkt.].

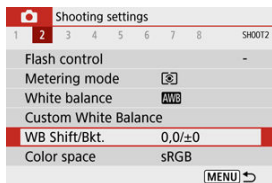

## 2. Set the white balance correction.

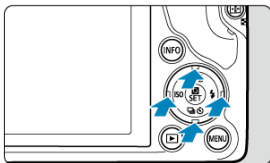

Sample setting: A2, G1

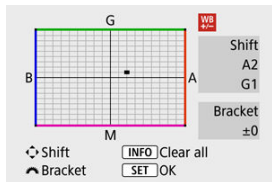

- Press the <▲▼> or <◀▶> keys to move the "■" mark to your preferred position.
- B is for blue, A for amber, M for magenta, and G for green. White balance is corrected in the direction you move the mark. On the right of the screen, **[Shift]** indicates the direction and correction amount, respectively.
- Pressing the <INFO> button will cancel all the **[WB Shift/Bkt.]** settings.
- Press the <SET> button to exit setup.

### Note

- One level of the blue/amber correction is equivalent to approx. 5 mireds of a color temperature conversion filter. (Mired: Unit of measure for color temperature used to indicate values such as the density of a color temperature conversion filter.)

## White Balance Auto Bracketing

White balance bracketing enables you to capture three images at once with different color tones.

### Setting the white balance bracketing amount

B/A bias  $\pm 3$  levels

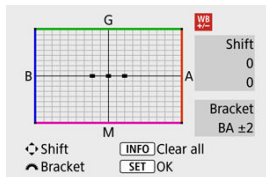

- In step 2 for [White Balance Correction](#), when you turn the dial, the "■" mark on the screen will change to "■ ■ ■" (3 points).
- Turning the dial clockwise sets the B/A bracketing, and turning it counterclockwise sets the M/G bracketing.  
On the right of the screen, **[Bracket]** indicates the bracketing direction and correction amount.
- Pressing the < **INFO** > button will cancel all the **[WB Shift/Bkt.]** settings.
- Press the < > button to exit setup.

#### Caution

- During white balance bracketing, the maximum burst for continuous shooting will be lower.
- Since three images are recorded for one shot, it takes longer to record the image to the card.

#### Note

- The images will be bracketed in the following sequence: 1. Standard white balance, 2. Blue (B) bias, and 3. Amber (A) bias, or 1. Standard white balance, 2. Magenta (M) bias, and 3. Green (G) bias.
- You can also set white balance correction and AEB together with white balance bracketing. If you set AEB in combination with white balance bracketing, a total of nine images will be recorded for a single shot.
- The white balance icon blinks when WB bracketing is set. (If the icon is not shown, press the < **INFO** > button repeatedly to switch the display.)
- **Bracket** stands for bracketing.

## [Adobe RGB](#)

The range of reproducible colors is called the “color space.” For normal shooting, sRGB is recommended.

---

1. Select [: Color space].
2. Set a color space option.

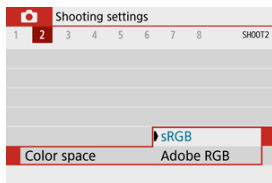

## Adobe RGB

---

This color space is mainly used for commercial printing and other professional applications. Recommended when using equipment such as Adobe RGB-compatible monitors or DCF 2.0 (Exif 2.21 or later) compatible printers.

### Note

- File names of still photos shot in the Adobe RGB color space begin with “\_”.
- The ICC profile is not appended. For the descriptions about the ICC profile, refer to the Digital Photo Professional Instruction Manual (EOS software).
- In Basic Zone, [sRGB] is set automatically.

## [Picture Style Characteristics](#)

## [Symbols](#)

Just by selecting a preset Picture Style, you can obtain image characteristics effectively matching your photographic expression or the subject.

### 1. Select [: Picture Style].

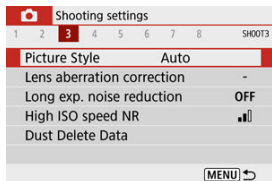

### 2. Select a Picture Style.

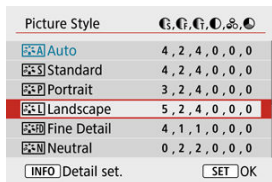

## Picture Style Characteristics

- **[A]** **Auto**

The color tone will be adjusted automatically to suit the scene. The colors will look vivid for blue skies, greenery and sunsets, particularly in nature, outdoor, and sunset scenes.

 **Note**

- If the desired color tone is not obtained with **[Auto]**, use another Picture Style.

- **[S]** **Standard**

The image looks vivid, sharp, and crisp. Suitable for most scenes.

- **[P]** **Portrait**

For smooth skin tones, with slightly less sharpness. Suited for close-up portraits.

Skin tone can be adjusted by changing **[Color tone]** as described in [Settings and Effects](#).

- **[L]** **Landscape**

For vivid blues and greens, and very sharp and crisp images. Effective for impressive landscapes.

- **[F]** **Fine Detail**

For detailed rendering of fine subject contours and subtle textures. The colors will be slightly vivid.

- **[N]** **Neutral**

For retouching later on a computer. Makes images subdued, with lower contrast and natural color tones.

- **[F]** **Faithful**

For retouching later on a computer. Faithfully reproduces the actual colors of subjects as measured in daylight with a color temperature of 5200K. Makes images subdued, with lower contrast.

- **[M]** **Monochrome**

Creates black-and-white images.

 **Caution**

- Color images cannot be recovered from JPEG images shot with the **[Monochrome]** Picture Style.



-  **User Def. 1–3**

You can add a new style based on presets such as **[Portrait]** or **[Landscape]** or a Picture Style file, then adjust it as needed (). Shots taken with a style you have not customized yet will have the same characteristics as the default **[Auto]** setting.

## Symbols

Icons on the Picture Style selection screen represent **[Strength]**, **[Fineness]**, and **[Threshold]** for **[Sharpness]** as well as **[Contrast]** and other parameters. The numbers indicate the values for these settings specified for the respective Picture Style.

Picture Style	<b>[Strength]</b>	<b>[Fineness]</b>	<b>[Threshold]</b>	Picture Style	<b>[Strength]</b>	<b>[Fineness]</b>	<b>[Threshold]</b>
<b>[A]</b> Auto	4	2	4	0	0	0	0
<b>[S]</b> Standard	4	2	4	0	0	0	0
<b>[P]</b> Portrait	3	2	4	0	0	0	0
<b>[L]</b> Landscape	5	2	4	0	0	0	0
<b>[F]</b> Fine Detail	4	1	1	0	0	0	0
<b>[N]</b> Neutral	0	2	2	0	0	0	0
<b>[Fa]</b> Faithful	0	2	2	0	0	0	0
<b>[M]</b> Monochrome	4	2	4	0	N	N	N
<b>[U1]</b> User Def. 1				Auto			
<b>[U2]</b> User Def. 2				Auto			
<b>[INFO]</b> Detail set.	<b>[SET]</b> OK			<b>[INFO]</b> Detail set.	<b>[SET]</b> OK		

<b>[Sharpness]</b>	<b>[Strength]</b>
	<b>[Fineness]</b>
	<b>[Threshold]</b>
<b>[Contrast]</b>	
<b>[Saturation]</b>	
<b>[Color tone]</b>	
<b>[Filter effect (Monochrome)]</b>	
<b>[Toning effect (Monochrome)]</b>	

### Caution

- For movie recording, \* is indicated for both **[Fineness]** and **[Threshold]** parameters of **[Sharpness]**. **[Fineness]** and **[Threshold]** are not applied to movies.

☑ [Settings and Effects](#)

☑ [\[P\] Monochrome Adjustment](#)

You can customize any Picture Style by changing it from the default settings. For details on customizing **[Monochrome]**, see [\[P\] Monochrome Adjustment](#).

## 1. Select [P]: Picture Style.

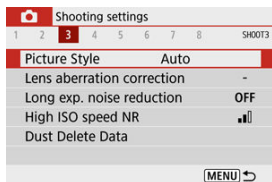

## 2. Select a Picture Style.

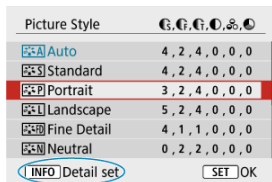

- Select the Picture Style to adjust, then press the <INFO> button.

### 3. Select an option.

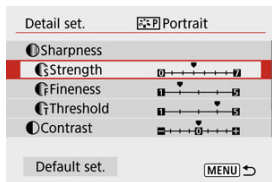

- For details on settings and effects, see [Settings and Effects](#).

### 4. Set the effect level.

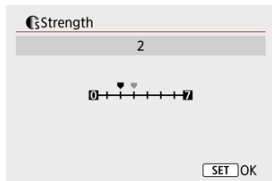



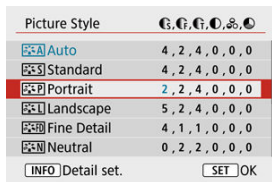



- Set the value, then press <SET>.



- Press the <MENU> button to save the adjusted setting and return to the Picture Style selection screen.
- Any settings you change from default values are displayed in blue.

## Settings and Effects

 <b>Sharpness</b>	 <b>Strength</b>	0: Weak outline emphasis	7: Strong outline emphasis
	 <b>Fineness<sup>*1</sup></b>	1: Fine	5: Grainy
	 <b>Threshold<sup>*2</sup></b>	1: Low	5: High
 <b>Contrast</b>		-4: Low contrast	+4: High contrast
 <b>Saturation</b>		-4: Low saturation	+4: High saturation
 <b>Color tone</b>		-4: Reddish skin tone	+4: Yellowish skin tone

\* 1: Indicates the edge thinness that enhancement applies to. The smaller the number, the finer the outlines that can be emphasized.

\* 2: Contrast threshold between edges and surrounding image areas, which determines edge enhancement. The smaller the number, the more the outline will be emphasized when the contrast difference is low. However, noise tends to be more noticeable when the number is smaller.



### Note

- For movie recording, [**Fineness**] and [**Threshold**] settings are not shown in [**Sharpness**] and cannot be set.
- By selecting [**Default set.**] in step 3, you can restore the parameter settings of the respective Picture Style to the defaults.
- To shoot with the Picture Style you adjusted, first select the adjusted Picture Style, then shoot.

## [] Monochrome Adjustment

### [] Filter effect

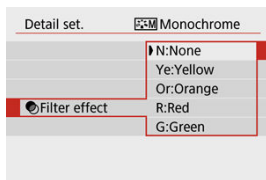

With a filter effect applied to a monochrome image, you can make white clouds or green trees stand out more.

Filter	Sample Effects
<b>N:None</b>	Normal black-and-white image with no filter effects.
<b>Ye:Yellow</b>	Blue sky will look more natural, and white clouds will look crisper.
<b>Or:Orange</b>	The blue sky will look slightly darker. The sunset will look more brilliant.
<b>R:Red</b>	The blue sky will look quite dark. Fall leaves will look crisper and brighter.
<b>G:Green</b>	Skin tones and lips will appear muted. Green tree leaves will look crisper and brighter.

#### Note

- Increasing [] **Contrast** intensifies the filter effect.

## [🔍] Toning effect

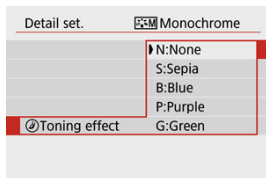

By applying a toning effect, you can create a monochrome image in the selected color. Effective when you want to create memorable images.

You can select a base Picture Style such as **[Portrait]** or **[Landscape]**, adjust it as desired, and register it under **[User Def. 1]** – **[User Def. 3]**. Useful when creating several Picture Styles with different settings.

Picture Styles that you have registered on the camera using EOS Utility (EOS software, [🔗](#)) can also be modified here.

## 1. Select **[Picture Style]**.

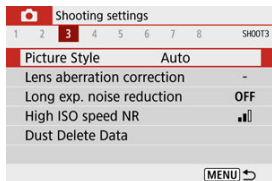

## 2. Select a user-defined style number.

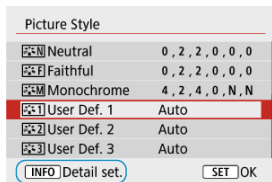

- Select a number from **[User Def. 1]** to **[User Def. 3]**, then press the **<INFO>** button.



### 3. Press the < > button.

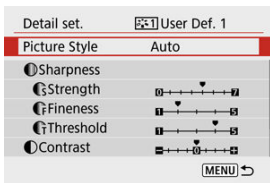

- With [Picture Style] selected, press the <  > button.

### 4. Select a base Picture Style.

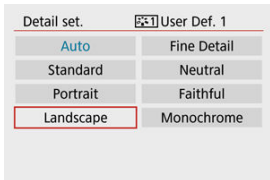

- Select the base Picture Style.
- Also select styles this way when adjusting styles registered to the camera with EOS Utility (EOS software).

### 5. Select an option.

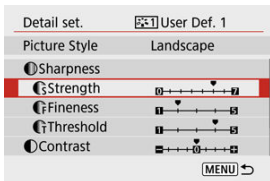

## 6. Set the effect level.

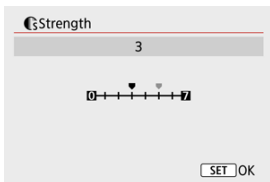

- For details, see [Picture Style Customization](#).

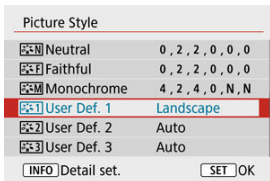

- Press the <MENU> button to save the adjusted setting and return to the Picture Style selection screen.  
The base Picture Style will be indicated on the right of [User Def. \*].  
Blue style names indicate that you have changed the settings from default values.

### Caution

- If a Picture Style is already registered under [User Def. \*], changing the base Picture Style will clear the parameter settings of the previously registered User Defined Picture Style.
- [User Def. \*] settings are reset when [Basic settings] in [Reset camera] is performed.

### Note

- To shoot with a registered Picture Style, select the registered [User Def. \*], then shoot.
- Regarding the procedure to register a Picture Style file to the camera, refer to the EOS Utility Instruction Manual.

- [Peripheral Illumination Correction](#)
- [Distortion Correction](#)
- [Digital Lens Optimizer](#)
- [Chromatic Aberration Correction](#)
- [Diffraction Correction](#)

Vignetting, image distortion, and other issues may be caused by lens optical characteristics. The camera can compensate for these phenomena by using **[Lens aberration correction]**.

## 1. Select [📷: Lens aberration correction].

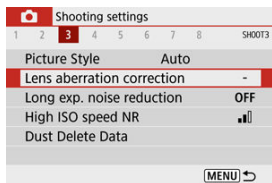

## 2. Select an option.

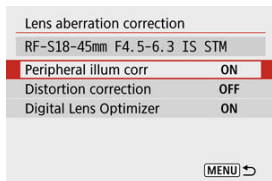

### 3. Select [Enable].

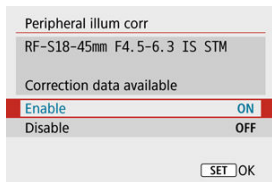

- Confirm that the name of the attached lens and [**Correction data available**] are displayed (except when [**Diffraction correction**] is set).
- If [**Correction data not available**] or a [📷] icon is displayed, see [Digital Lens Optimizer](#).

## Peripheral Illumination Correction

Vignetting (dark image corners) can be corrected.

### ⚠ Caution

- Depending on shooting conditions, noise may appear on the image periphery.
- The higher the ISO speed, the lower the amount of correction will be.

### 📷 Note

- The amount of correction applied will be lower than the maximum correction amount applied with Digital Photo Professional (EOS software).
- Peripheral illumination is corrected automatically in Basic Zone modes when correction data is registered on the camera.

## Distortion Correction

---

Distortion (image warping) can be corrected.

### Caution

- Specifying distortion correction may subtly change the angle of view, resulting in images that are cropped a little and seem slightly less sharp.
- The amount of image cropped may vary between still photos and movies.

### Note

- With RF lenses, distortion correction during movie recording is supported.

## Digital Lens Optimizer

Various aberrations from lens optical characteristics can be corrected, along with diffraction and loss of resolution.

If [**Correction data not available**] or  is displayed by [**Digital Lens Optimizer**], you can use EOS Utility to add the lens correction data to the camera. For details, refer to the EOS Utility Instruction Manual.

### Caution

- Depending on shooting conditions, noise may be intensified together with the effects of correction. Image edges may also be emphasized. Adjust Picture Style sharpness or set [**Digital Lens Optimizer**] to [**Disable**] as needed before shooting.
- The higher the ISO speed, the lower the amount of correction will be.
- For movie recording, [**Digital Lens Optimizer**] will not appear. (Correction is not possible.)

### Note

- Enabling [**Digital Lens Optimizer**] will correct both chromatic aberration and diffraction when you shoot, although these options are not displayed.

## Chromatic Aberration Correction

---

Chromatic aberration (color fringing around subjects) can be corrected.



### Note

- [Chromatic aberr corr] is not displayed when [Digital Lens Optimizer] is set to [Enable].

## Diffraction Correction

---

Diffraction (loss of sharpness caused by the aperture) can be corrected.

### Caution

- Depending on shooting conditions, noise may be intensified together with the effects of correction.
- The higher the ISO speed, the lower the amount of correction will be.
- For movie recording, [**Diffraction correction**] will not appear. (Correction is not possible.)
- The effect of diffraction correction cannot be checked on the screen at the time of shooting.

### Note

- [**Diffraction correction**] is not displayed when [**Digital Lens Optimizer**] is set to [**Enable**].

### Caution

#### General precautions for lens aberration correction

- Lens aberration correction cannot be applied to existing JPEG images.
- When using a non-Canon lens, setting the corrections to [**Disable**] is recommended even if [**Correction data available**] is displayed.
- Magnifying the periphery of the image may display parts of the image that will not be recorded.
- The amount of correction (except diffraction correction) is less for lenses that do not provide distance information.



 **Note****General notes for lens aberration correction**

- Effects of lens aberration correction vary by lens and shooting conditions. Also, the effect may be difficult to discern depending on the lens used, shooting conditions, etc.
- If the correction is difficult to discern, magnifying and checking the image after shooting is recommended.
- Corrections are applied even when a life-size converter is attached.
- If the correction data for the attached lens is not registered to the camera, the result will be the same as when the correction is set to **[Disable]** (except for diffraction correction).
- If necessary, refer to the EOS Utility Instruction Manual as well.

[Long Exposure Noise Reduction](#)

[High ISO Speed Noise Reduction](#)

## Long Exposure Noise Reduction

Noise that tends to occur in long exposures at shutter speeds of one sec. or slower can be reduced.

1. Select [: Long exp. noise reduction].

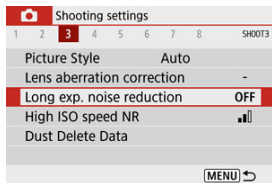

## 2. Set a reduction option.

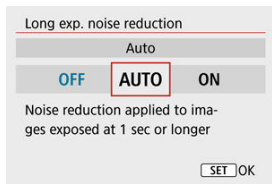

- **[AUTO] Auto**  
For images exposed for 1 sec. or longer, noise reduction is performed automatically if noise typical of long exposures is detected. This setting is effective enough in most cases.
- **[ON] Enable**  
Noise reduction is performed for all images exposed for 1 sec. or longer. The **[Enable]** setting may reduce noise that cannot be detected with the **[Auto]** setting.

### ⚠ Caution

- With **[Auto]** or **[Enable]** set, noise reduction after you shoot may take as long as exposure for the shot.
- Images may look grainier with the **[Enable]** setting than with the **[Disable]** or **[Auto]** setting.
- After you shoot a long exposure with **[Enable]** set, the shooting screen is not displayed during noise reduction processing (indicated by **[BUSY]** display), and you cannot shoot again until processing is finished.

## High ISO Speed Noise Reduction

You can reduce the image noise generated. This function is especially effective when shooting at high ISO speeds. When shooting at low ISO speeds, the noise in the darker parts of the image (shadow areas) can further be reduced.

### 1. Select [📷: High ISO speed NR].

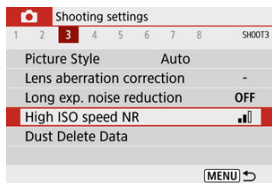

### 2. Set the level.

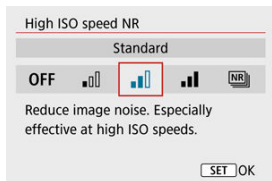

#### ● [NR] Multi Shot Noise Reduction

Applies noise reduction with higher image quality than [High]. For a single photo, four shots are taken continuously and aligned and merged automatically into a single JPEG image.

Note that [Multi Shot Noise Reduction] is not available with image quality set to RAW or RAW+JPEG.

 Caution

**Precautions when set to [Multi Shot Noise Reduction]**

- If there is significant misalignment in the image due to camera shake, the noise reduction effect may become smaller.
- Be careful about camera shake in handheld shots. Using a tripod is recommended.
- If you shoot a moving subject, the moving subject may leave afterimages.
- Auto image alignment may not function properly with repetitive patterns (lattice, stripes, etc.) or flat, single-tone images.
- If the subject's brightness changes as the four consecutive shots are taken, irregular exposure in the image may result.
- After shooting, it may take some time to record an image to the card after performing noise reduction and merging the images. **[BUSY]** is displayed on the shooting screen during image processing. Shooting is not possible until processing is finished.
- **[Multi Shot Noise Reduction]** is not available when features such as these are set: bulb exposures, AEB or WB bracketing, RAW or RAW+JPEG shooting, long exposure noise reduction, or Creative filters.
- Flash photography is not available. Note that the AF-assist beam may be fired, depending on the : **AF-assist beam firing** setting.
- **[Multi Shot Noise Reduction]** is not available (not displayed) when recording movies.
- Automatically switches to **[Standard]** if you set the power switch to **< OFF >**, replace the battery or card, or switch to Basic Zone modes, bulb exposure, or movie recording.

[Preparation](#)

[Dust Delete Data Acquisition](#)

[Dust Delete Data Appending](#)

Dust Delete Data used to erase dust spots can be appended to images. The Dust Delete Data is used by Digital Photo Professional (EOS software) to erase the dust spots automatically.

---

### Preparation

---

- Use an RF or EF lens.
- Prepare a solid white object such as a sheet of paper.
- Set the lens focal length to 50 mm or longer.
- Set the focus mode to MF () , then set the focus to infinity ( $\infty$ ) by turning the focusing ring clockwise, as viewed from the front of the camera.

### 1. Select [OK]: Dust Delete Data].

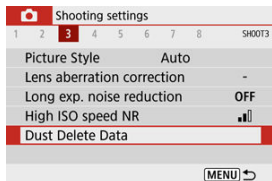

### 2. Select [OK].

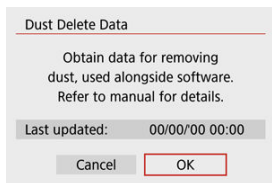

### 3. Shoot a plain white object.

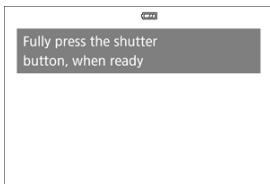

- Shoot with a plain white object (such as a new sheet of white paper) filling the screen, at a distance of 20–30 cm (0.7–1.0 ft.).
- Since the image will not be saved, the data can still be obtained even if there is no card in the camera.

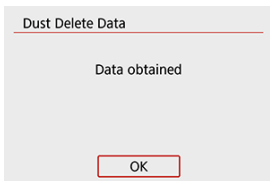

- When the picture is taken, the camera will start collecting the Dust Delete Data. When the Dust Delete Data is obtained, a message will appear.
- If the data is not obtained successfully, an error message will appear. Check the information in [Preparation](#), select **[OK]**, and shoot again.



## Dust Delete Data Appending

Once acquired, Dust Delete Data is appended to still photos captured after that point. Acquiring Dust Delete Data before shooting is recommended.

For details about using Digital Photo Professional (EOS software) to erase dust spots automatically, refer to the Digital Photo Professional Instruction Manual.

File size is essentially unaffected by Dust Delete Data appended to images.

### Caution

- If the object has any pattern or design, it may be recognized as dust data and affect the accuracy of the dust deletion with the Digital Photo Professional (EOS software).
- Dust Delete Data is not added to shots taken under the following conditions.
  - In [P] or [Av] (< SCN > mode) shooting
  - In [Av] (< Av > mode) shooting
  - When multi-shot noise reduction is set
  - When [Distortion correction] in [Lens aberration correction] is set to [Enable]



You can specify the method of focusing (focus mode).

## 1. Select [📷: Focus mode].

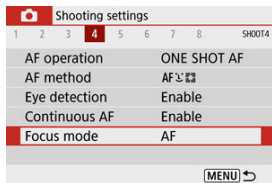

## 2. Select an option.

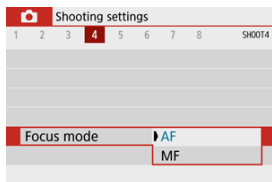

- [AF]: Autofocus
- [MF]: Manual focus

### ⚠ Caution

- [📷: Focus mode] is not displayed when the focal position is in the effective range exclusively for manual focusing (MF). Turn the focusing ring toward infinity (clockwise, as viewed from the front of the camera) to move the focal position until [📷: Focus mode] appears.

# AF-Assist Beam Firing

---

You can enable firing of the camera's AF-assist beam.

---

1. Select [: AF-assist beam firing].

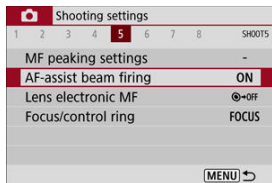

2. Select an option.

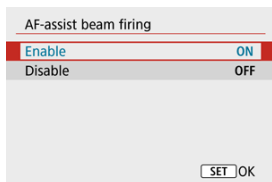

- **[ON] Enable**  
Enables firing of the AF-assist beam, when needed.
- **[OFF] Disable**  
Disables firing of the AF-assist beam. Set if you prefer not to fire the AF-assist beam.

For lenses equipped with electronic manual focusing, you can specify how manual focus adjustment is used with One-Shot AF.

## 1. Select [📷: Lens electronic MF].

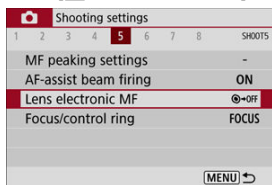

## 2. Select an item.

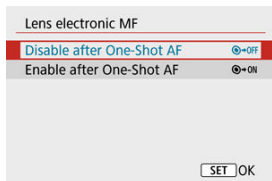

- **Disable after One-Shot AF**  
After the AF operation, manual focusing adjustment is disabled.
- **Enable after One-Shot AF**  
You can manually adjust the focus after the AF operation if you keep holding down the shutter button halfway.

### ! Caution

- For details on your lens's manual focus specifications, refer to the Lens Instruction Manual.

Menu-based switching of lens focus/control ring functionality.

## ⚠ Caution

- Available when using lenses that have a combination focusing ring/control ring but have no switch to switch between these features.

### 1. Select [📷: Focus/control ring].

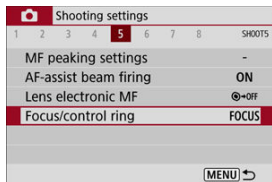

### 2. Select the functionality to use.

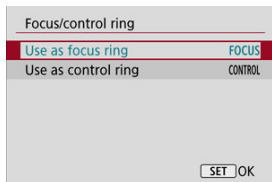

- **[Use as focus ring]**  
The ring works as a focusing ring.
- **[Use as control ring]**  
The ring works as a control ring.

## Image Stabilizer (IS Mode)

Image stabilization by the lens reduces camera shake at the time of shooting. To activate lens IS when using IS lenses without an IS switch, set **[IS mode]** to **[On]** as follows. Note that the **[IS mode]** setting is not displayed when you are using IS lenses that have an IS switch. In that case, setting the lens IS switch to **< ON >** activates stabilization by the lens.

### 1. Select **[📷: IS (Image Stabilizer) mode]**.

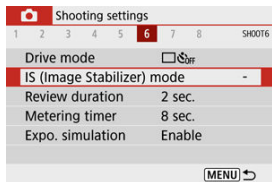

### 2. Select an **[IS mode]** option.

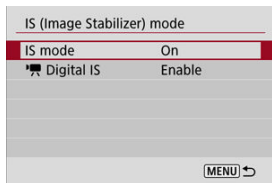

- **[Off]**  
Deactivates image stabilization.
- **[On]**  
Camera shake will be corrected.

#### Caution

- In some cases, this may not provide sufficient stabilization for certain lenses.



#### Note

- For details on image stabilization for movie recording, see [Movie Digital IS](#).



## Review Duration

---

Set to **[Hold]** to keep the captured image displayed after you shoot, or set to **[Off]** if you prefer not to have shots displayed.

---

### 1. Select **[: Review duration]**.

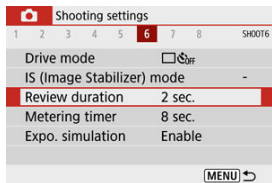

### 2. Set a time option.

#### Note

- When **[Hold]** is set, images are displayed until the time set in **[: Power saving]** elapses.

You can set how long the metering timer runs (which determines the duration of exposure value display) after it is triggered automatically by an action such as pressing the shutter button halfway.

---

1. Select [📷: Metering timer].

2. Set a time option.

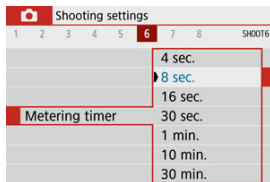

With exposure simulation, image brightness more closely matches the actual brightness (exposure) of your shots.

---

## 1. Select [📷: Expo. simulation].

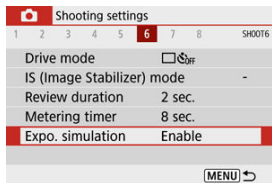

## 2. Select an option.

- **[Enable] (Exp.SIM)**  
The displayed image brightness will be close to the actual brightness (exposure) of the resulting image. If you set exposure compensation, the image brightness will change accordingly.
- **[Disable] (DISP)**  
The image is displayed at standard brightness, so it is easy to see. Even if you set exposure compensation, the image is displayed at the standard brightness.

# Shooting Information Display

---

- [Customizing Information on the Screen](#)
- [Customizing Information in the Viewfinder](#)
- [Viewfinder Vertical Display](#)
- [Grid](#)
- [Histogram](#)
- [Clearing Settings](#)

You can customize the details and screens of information shown on the screen or in the viewfinder when you shoot.

---

## Customizing Information on the Screen

---

1. Select [: Shooting info. disp.].

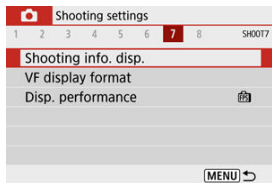

2. Select [Screen info. settings].

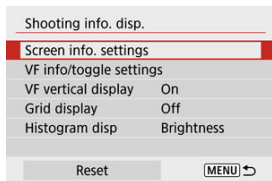

### 3. Select screens.

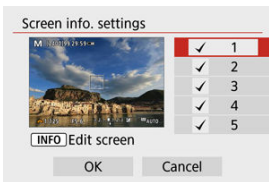

- Press the <▲><▼> keys to select screens of information to show on the camera.
- For information you prefer not to display, press the <Ⓜ> button to clear the checkmark [✓].
- To edit the screen, press the <INFO> button.

### 4. Edit the screen.

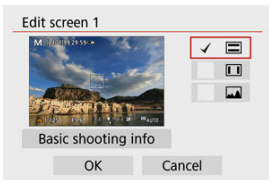

- Press the <▲><▼> keys to select options to show on the information screen.
- For items you prefer not to display, press the <Ⓜ> button to clear the checkmark [✓].
- Select [OK] to register the setting.

### 1. Select [📷: Shooting info. disp.].

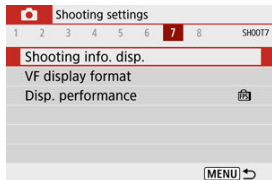

### 2. Select [VF info/toggle settings].

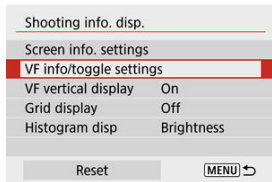

### 3. Select screens.

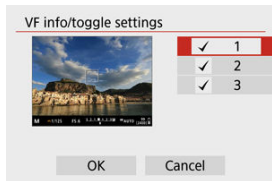

- Press the <▲><▼> keys to select information screens to show in the viewfinder.
- For information you prefer not to display, press the <Ⓢ> button to clear the checkmark [✓].
- To edit the screens when screen 2 or 3 is selected, press the <INFO> button.

## 4. Edit the screen.

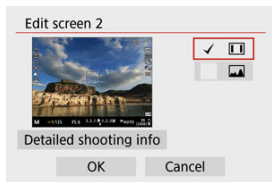

- Press the <▲><▼> keys to select options to show on the information screen in the viewfinder.
- For items you prefer not to display, press the <Ⓜ> button to clear the checkmark [✓].
- Select [OK] to register the setting.

## Viewfinder Vertical Display

You can select how viewfinder information is displayed when you are shooting still photos vertically.

### 1. Select [CAMERA: Shooting info. disp.].

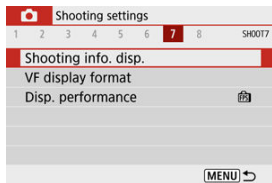

### 2. Select [VF vertical display].

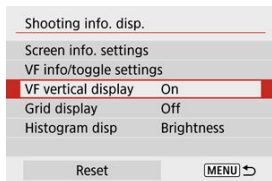



### 3. Select an option.

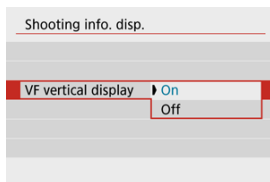

- **On**  
Information is automatically rotated, making it easier to read.
- **Off**  
Information is not automatically rotated.

A grid can be displayed on the screen and viewfinder.

## 1. Select [: Shooting info. disp.].

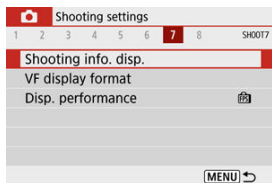

## 2. Select [Grid display].

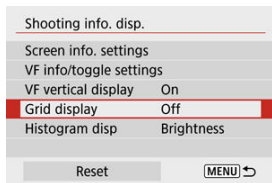

## 3. Select an option.

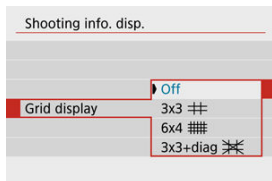

You can select the content and display size of the histogram.

## 1. Select [**Shooting info. disp.**].



## 2. Select [**Histogram disp.**].

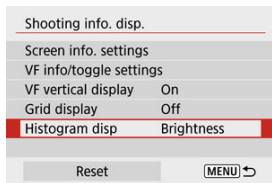

## 3. Select an option.

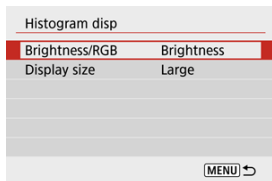

- Select the content ([**Brightness**] or [**RGB**]) and display size ([**Large**] or [**Small**]).

### 1. Select [CAMERA]: Shooting info. disp.].

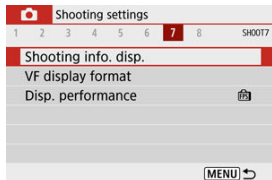

### 2. Select [Reset].

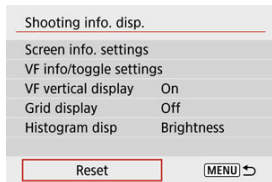

### 3. Select [OK].

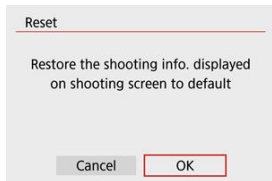

# Viewfinder Display Format

---

1. Select [VF]: VF display format].



2. Select an option.

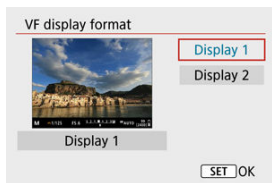

# Display Performance

---

You can select the performance parameter to prioritize in shooting screen display for still photos.

---

## 1. Select [📷: Disp. performance].

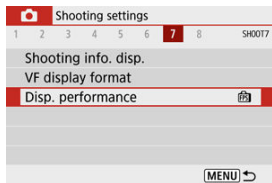

## 2. Select an option.

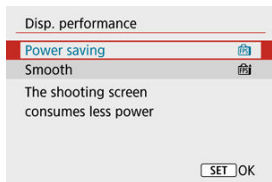

- **Power saving**  
Screen display consumes less power.
- **Smooth**  
Even quick-moving subjects are displayed smoothly.

# General Still Photo Shooting Precautions

 [During Shooting](#)

 [Information Display](#)

## During Shooting









### Caution

- Do not point the camera toward an intense light source, such as the sun or an intense artificial light source. Doing so may damage the image sensor or the camera's internal components.

#### Image quality

- Image noise (such as dots of light or banding) or irregular colors may be noticeable at high ISO speeds.
- Shooting in high temperatures may cause noise and irregular colors in the image.
- Frequent shooting over an extended period may cause high internal temperatures and affect image quality. When you are not shooting, always turn off the camera.
- If you shoot a long exposure while the camera's internal temperature is high, image quality may decline. Stop shooting and wait a few minutes before shooting again.



#### White and red icons

- White  or red  icons indicate high internal camera temperature, caused by factors such as extended shooting or use in hot environments.
- The white  icon indicates that the image quality of still photos will decline. Stop shooting for a while and allow the camera to cool down.
- Shooting at low ISO speeds instead of high speeds is recommended when the white  icon is displayed.
- The red  icon indicates that shooting will soon be terminated automatically. Shooting will not be possible again until the camera cools down internally, so stop shooting temporarily or turn off the camera and let it cool down a while.
- Shooting in hot environments over extended periods will cause the white  or red  icon to appear sooner. When you are not shooting, always turn off the camera.
- If the camera's internal temperature is high, the quality of images shot with a high ISO speed or long exposure may decline even before the white  icon is displayed.

## Shooting results

- In magnified view, the shutter speed and aperture value will be displayed in orange. If you take the picture in magnified view, the exposure may not come out as desired. Return to the normal view before taking the picture.
- Even if you take the picture in magnified view, the image will be captured with the image area of the normal view.

## Images and display

- Under low- or bright-light conditions, the displayed image may not reflect the brightness of the captured image.
- Although noise may be noticeable in images under low light (even at low ISO speeds), there will be less noise in your shots, due to differences in image quality between displayed and captured images.
- The screen or exposure value may flicker if the light source (lighting) changes. In this case, stop shooting temporarily and resume under the light source you will use.
- Pointing the camera at different direction may momentarily prevent correct display of brightness. Wait until the brightness level stabilizes before shooting.
- If there is a very bright light source in the image, the bright area may appear black on the screen. However, the actual captured image will correctly show the bright area.
- Under low light, bright [: **Screen brightness**] or [: **Viewfinder brightness**] settings may cause noise or irregular colors in images. However, the noise or irregular colors will not be recorded in the captured image.
- When you magnify the image, the image sharpness may look more pronounced than in the actual image.

## Custom Functions

- Some Custom Functions are not available (some settings have no effect).

## Lens

- Image Stabilizer is active all times, even without the shutter button pressed halfway, when you use IS-equipped lenses with the IS switch set to < ON > and [IS mode] in [: **IS (Image Stabilizer) mode**] is set to [On]. The Image Stabilizer consumes battery power and may decrease the number of available shots depending on the shooting conditions. When the Image Stabilizer is not necessary, such as when using a tripod, it is recommended that you set the Image Stabilizer switch to < OFF >.
- With EF lenses, focus preset during shooting is only available when using (super) telephoto lenses equipped with this function released in and after the second half of 2011.



### Note

- Using a commercially available HDMI cable, you can display images on a television (). Note that no sound will be output.



## Information Display

For details on the icons displayed for still photo shooting, see [Still Photo Shooting Screen](#).





### Note

- White display of the [Exp.SIM] icon indicates that your shots will be about as bright as the image displayed.
- If the [Exp.SIM] icon is blinking, it indicates that the image is displayed at a brightness that differs from the actual shooting result because of low- or bright-light conditions. However, the actual image recorded will reflect the exposure setting. Note that the noise may be more noticeable than the actual image recorded.
- Exposure simulation may not be performed under some shooting settings. The [Exp.SIM] icon and histogram will be displayed in gray. The image will be displayed on the screen at the standard brightness. The histogram may not be properly displayed in low- or bright-light conditions.
- Histogram display is available when [📷: Expo. simulation] is set to [Enable] (🔗).

## Movie Recording

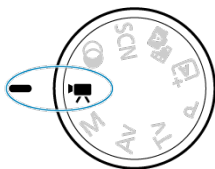
---



For movie recording, set the Mode dial to <  >.

### Caution

- When switching from still photo shooting to movie recording, check the camera settings again before recording movies.

### Note

- You can record movies by pressing the movie shooting button during still photo shooting.

- [Tab Menus: Movie Recording](#)
- [Movie Recording](#)
- [Movie Recording Quality](#)
- [Sound Recording](#)
- [Time-Lapse Movies](#)
- [Movie Servo AF](#)
- [Digital Zoom](#)
- [Shutter Button Function for Movies](#)
- [Movie Self-Timer](#)
- [Movie Digital IS](#)
- [Miniature Effect Movies](#)
- [Other Menu Functions](#)
- [General Movie Recording Precautions](#)

# Tab Menus: Movie Recording

## ● Shooting 1

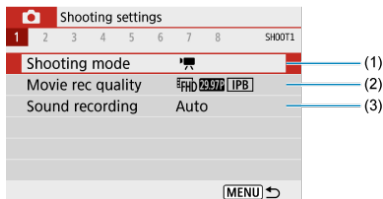

- (1) [Shooting mode](#)
- (2) [Movie rec quality](#)
- (3) [Sound recording](#)

## ● Shooting 2

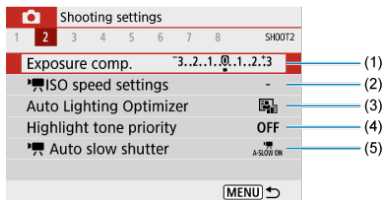

- (1) [Exposure comp.](#)
- (2) [ISO speed settings](#)
- (3) [Auto Lighting Optimizer](#)
- (4) [Highlight tone priority](#)
- (5) [Auto slow shutter](#)

## ● Shooting 3

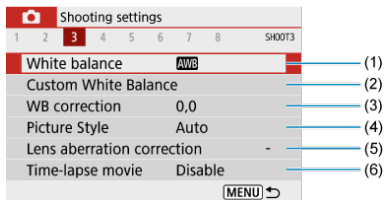

- (1) [White balance](#)
- (2) [Custom White Balance](#)
- (3) [WB correction](#)
- (4) Picture Style
  - [Picture Style Selection](#)
  - [Picture Style Customization](#)
  - [Picture Style Registration](#)
- (5) [Lens aberration correction](#)
- (6) [Time-lapse movie](#)

## ● Shooting 4

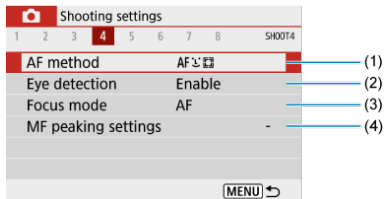

- (1) [AF method](#)
- (2) [Eye detection](#)
- (3) [Focus mode](#)
- (4) [MF peaking settings](#)

## ● Shooting 5

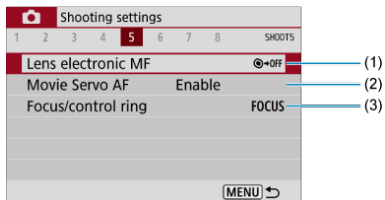

- (1) [Lens electronic MF](#)
- (2) [Movie Servo AF](#)
- (3) [Focus/control ring](#)

## ● Shooting 6

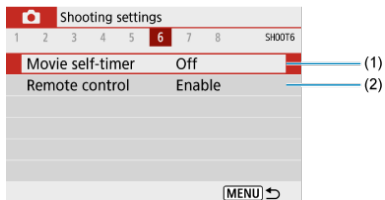

- (1) [Movie self-timer](#)
- (2) [Remote control](#)

## ● Shooting 7

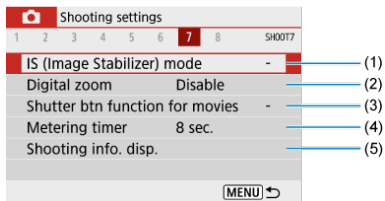

- (1) [IS \(Image Stabilizer\) mode](#)
- (2) [Digital zoom](#)
- (3) [Shutter btn function for movies](#)
- (4) [Metering timer](#)
- (5) [Shooting info. disp.](#)

## ● Shooting 8

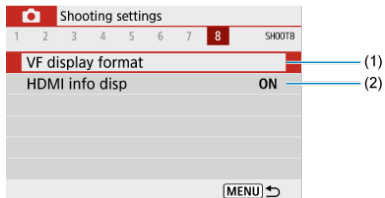

- (1) [VF display format](#)
- (2) [HDMI info disp](#)

# Movie Recording

---

- [Autoexposure Movie Recording](#)
- [Manual Exposure Movie Recording](#)
- [ISO Speed in Manual Exposure Recording](#)
- [Still Photo Shooting](#)
- [Information Display \(Movie Recording\)](#)

## Autoexposure Movie Recording

---

Exposure is controlled automatically to suit the brightness.

1. Set the Mode dial to <  >.

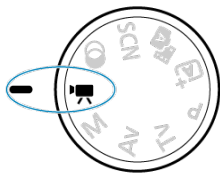

2. Select [: Shooting mode].

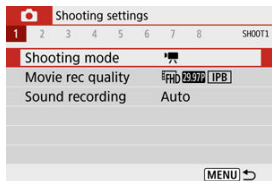

### 3. Select [Movie auto exposure].

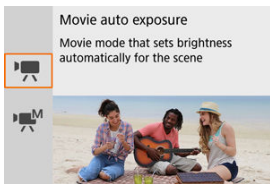

### 4. Focus on the subject.

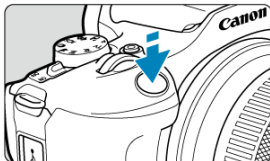

- Before recording a movie, focus with AF (AF-ON) or manually (MF).
- By default, [CAMERA: Movie Servo AF] is set to [Enable] so that the camera always keeps focusing (AF-ON).
- Pressing the shutter button halfway focuses using the current AF method.



## 5. Record the movie.

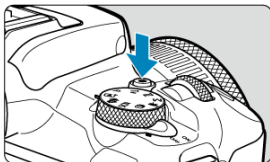

- Press the movie shooting button to start recording a movie.

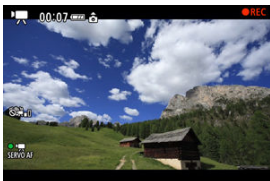

- While the movie is being recorded, the [●REC] icon will be displayed in the upper right of the screen.
- Sound is recorded by the built-in microphone (🔊).
- To stop recording the movie, press the movie shooting button again.

## ISO Speed in [P/A] Mode

- ISO speed is set automatically. For details on ISO speed, see [ISO Speed in Movie Recording](#).



### Note

- You can lock the exposure (AE lock) by pressing the < \* > button (AE-L/AF-ON). To cancel AE lock, press the < \* > button again.
- Exposure compensation in manual exposure movie recording can be set in a range of up to  $\pm 3$  stops.
- ISO speed, shutter speed, and aperture value are not recorded in movie Exif information.

## Manual Exposure Movie Recording

You can manually set the shutter speed, aperture value, and ISO speed for movie recording.

1. Set the Mode dial to **<M>**.

2. Select [**Movie**]: Shooting mode].

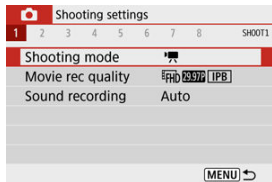

3. Select [**Movie manual exp.**].

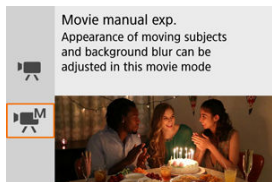



4. Set the ISO speed.

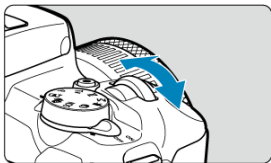

- Press **<M>**.  
The ISO speed setting screen is displayed.
- Set with the **<Sun>** dial or **<M/OK>** keys.

## 5. Set the shutter speed and aperture value.



- Press the shutter button halfway and check the exposure level indicator.
- Press the < ▲ > key to select the shutter speed or aperture value, then turn the <  > dial to set a value.
- Shutter speed can be set in a range of 1/4000–1/8 sec.

## 6. Focus and record the movie.

- Same as step 4 in [Autoexposure Movie Recording](#).

### Caution

- During movie recording, avoid changing the shutter speed, aperture value, or ISO speed, which may record changes in the exposure or create more noise at high ISO speeds.
- When recording a movie of a moving subject, a shutter speed of approx. 1/25 sec. to 1/125 sec. is recommended. The faster the shutter speed, the less smooth the subject's movement will look.
- Flickering shown on the screen when recording under fluorescent or LED lighting may be recorded if you change the shutter speed.



#### Note

- With ISO Auto, exposure compensation can be set in a range of  $\pm 3$  stops (🔒).
- To lock the ISO speed when ISO Auto is set, press the < \* > button. Press the < \* > button again to cancel ISO speed locking.
- If you press the < \* > button and recompose the shot, you can see the exposure level difference on the exposure level indicator compared to when the < \* > button was pressed.

## ISO Speed in Manual Exposure Recording

---

You can set the ISO speed manually or select **[AUTO]**. For details on ISO speed, see [ISO Speed in Movie Recording](#).

## Still Photo Shooting

---

**Still photos cannot be taken during movie recording.** To shoot still photos, turn the Mode dial to switch to another shooting mode.

## Information Display (Movie Recording)

---

For details on the icons on the movie recording screen, see [Movie Recording Screen](#).

# Movie Recording Quality

---

- [Movie Recording Size](#)
- [4K Movie Recording](#)
- [Frame Rate \(fps: frames per second\)](#)
- [Compression Method](#)
- [Movie Recording Format](#)
- [Cards That Can Record Movies](#)
- [High Frame Rate](#)
- [Movie Files Exceeding 4 GB](#)
- [Total Movie Recording Time and File Size Per Minute](#)
- [Movie Recording Time Limit](#)

You can set the recording size, frame rate, and compression method in [📷: **Movie rec quality**]. The movie will be recorded as an MP4 file.

Note that the frame rate is updated automatically to match the [🔊: **Video system**] setting (🔗).

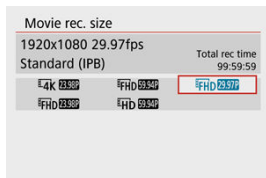

## Movie Recording Size

- **[4K] 3840×2160**  
The movie is recorded in 4K quality. The aspect ratio is **16:9**.
- **[FHD] 1920×1080**  
The movie will be recorded in Full High-Definition (Full HD) quality. The aspect ratio is **16:9**.
- **[HD] 1280×720**  
The movie is recorded in High-Definition (HD) quality. The aspect ratio is **16:9**.

### Caution

- If you change the [: Video system] setting, also set [Movie rec. size] again.
- Normal playback of 4K and [FHD 59.94P/50.00P] movies may not be possible on other devices, because playback is processing-intensive.
- Apparent resolution and noise vary depending on movie recording quality and settings for the lens used.

### Note

- Movies cannot be recorded in VGA quality.

## 4K Movie Recording

- Recording 4K movies requires a stable card with a fast writing speed. For details, see [Cards That Can Record Movies](#).
- 4K movie recording greatly increases the processing load, which may increase the internal camera temperature faster or higher than for regular movies. **If a red [70°C] icon appears during movie recording, the card may be hot, so stop recording the movie and let the camera cool down before removing the card. (Do not remove the card immediately.)**
- From a 4K movie, you can select any frame to save to the card as a JPEG still image ().

### Caution

- Contrast detection is used to focus when recording 4K movies. Focusing may take longer than when recording HD or Full HD movies.



## Frame Rate (fps: frames per second)

---

- **[59.94P] 59.94 fps/[29.97P] 29.97 fps/[23.98P] 23.98 fps**  
Set for areas using the NTSC TV system, such as North America, Japan, South Korea, and Mexico.
- **[50.00P] 50.00 fps/[25.00P] 25.00 fps**  
Set for areas using the PAL TV system, such as Europe, Russia, China, and Australia.

## Compression Method

---

- **[IPB] IPB (Standard)**  
Compresses multiple frames at a time efficiently for recording.
- **[ALL-I] ALL-I (For editing/I-only)**  
Uses ALL-I compression for time-lapse movie recording (📷). Compresses each frame, one at a time, for recording. Although file sizes are larger than with IPB (Standard), movies are more suitable for editing.

## Movie Recording Format

---

- **[MP4] MP4**  
All movies you record with the camera are recorded as movie files in MP4 format (file extension ".MP4").

## Cards That Can Record Movies

See [Card performance requirements \(movie recording\) \[write/read speed\]](#) for details on cards that can record at each level of movie recording quality.

**Test cards by recording a few movies to make sure they can record correctly at your specified size (🔗).**

### Caution

- Format cards before recording 4K movies (🔗).
- If you use a slow-writing card when recording movies, the movie may not be recorded properly. Also, if you play back a movie on a card with a slow reading speed, the movie may not be played back properly.
- When recording movies, use high-performance cards with a writing speed sufficiently higher than the bit rate.
- When movies cannot be recorded properly, format the card and try again. If formatting the card does not resolve the problem, refer to the card manufacturer's website, etc.

### Note

- To obtain better performance with the card, formatting the card with the camera before recording movies is recommended (🔗).
- To check the card's writing/reading speed, refer to the card manufacturer's website, etc.

## High Frame Rate

You can record HD movies at a high frame rate of 119.88 fps or 100.00 fps by setting **[High Frame Rate]** in **[Q: Movie rec quality]** to **[Enable]**. This is ideal for recording movies that will be played back in slow motion.

The maximum recording time per movie is 7 min. 29 sec.

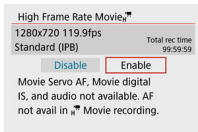

- Movies are recorded in **[HD 119.9P IPB]** or **[HD 100.0P IPB]** quality.
- Sound is not recorded in High Frame Rate movies.
- Because High Frame Rate movies are recorded as 29.97 fps/25.00 fps movie files, they are played back in slow motion at 1/4 speed.

### Caution

- Check the **[Movie rec. size]** setting if you return this setting to **[Disable]**.
- The screen may flicker if you record High Frame Rate movies under fluorescent or LED lighting.
- For a moment when you start or stop recording High Frame Rate movies, the movie is not updated, and the frame stops momentarily. Be aware of this when recording movies to external devices via HDMI.
- Movie frame rates shown on the screen as you record High Frame Rate movies do not correspond to the frame rate of the movie recorded.
- Sound is not recorded.
- Movie Servo AF and Movie digital IS are disabled.
- AF is not performed during High Frame Rate movie recording.

## Movie Files Exceeding 4 GB

Even if you record a movie exceeding 4 GB, you can keep recording without interruption.

- **Using SD/SDHC cards formatted with the camera**

FAT32 formatting is applied when the camera is used to format SD/SDHC cards.

With a FAT32-formatted card, if you record a movie and the file size exceeds 4 GB, a new movie file will be created automatically.

When you play back the movie, you will have to play back each movie file individually.

Movie files cannot be played back automatically in consecutive order. After the movie playback ends, select the next movie and play it back.

- **Using SDXC cards formatted with the camera**

exFAT formatting is applied when the camera is used to format SDXC cards.

When using an exFAT-formatted card, even if the file size exceeds 4 GB during movie recording, the movie will be saved as a single file (rather than being split into multiple files).

 **Caution**

- When importing movie files exceeding 4 GB to a computer, use either EOS Utility or a card reader (🔗). It may not be possible to save movie files exceeding 4 GB if you attempt this using standard features of the computer's operating system.

## Total Movie Recording Time and File Size Per Minute

---

For details on file sizes and the recording time available at each movie recording size, see [Estimated recording time and movie bit rate/file size](#).

## Movie Recording Time Limit

---

- **When recording 4K/Full HD/HD movies**

The maximum recording time per movie is 29 min. 59 sec. Once 29 min. 59 sec. is reached, recording automatically stops. You can start recording a movie again by pressing the movie shooting button (which records the movie as a new file).

- **When recording High Frame Rate movies**

The maximum recording time per movie is 7 min. 29 sec. Once 7 min. 29 sec. is reached, recording automatically stops. You can start recording a High Frame Rate movie again by pressing the movie shooting button (which records the movie as a new file).

## Sound Recording

[Sound Recording/Sound-Recording Level](#)

[Wind Filter](#)

[Attenuator](#)

You can record movies while recording sound with either the built-in microphone or an external one. You can also freely adjust the sound-recording level.

Use **[: Sound rec.]** to set sound recording functions.

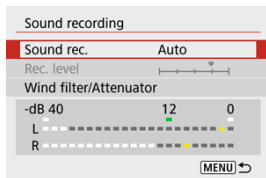

### Caution

- Sounds from Wi-Fi operations may be captured with built-in or external microphones. During sound recording, using the wireless communication function is not recommended.
- When connecting an external microphone to the camera, make sure the plug is fully inserted.
- The camera's built-in microphone will also record mechanical sounds of the lens or sounds of camera/lens operations if AF operations are performed or the camera is operated during movie recording. In this case, using an external microphone may reduce these sounds. If the sounds are still distracting with an external microphone, it may be more effective to remove the external microphone from the camera and position it away from the camera and lens.
- Do not connect anything other than an external microphone to the camera's external microphone IN terminal.

 **Note**

- In Basic Zone modes, the settings available for **[Sound recording]** are **[On]** and **[Off]**. Set to **[On]** for automatic adjustment of the recording level.
- Audio is also output when the camera is connected to televisions via HDMI, unless **[Sound rec.]** is set to **[Disable]**.
- Sound is recorded at a 48 kHz/16-bit sampling rate.

---

## Sound Recording/Sound-Recording Level

---

- **Auto**

The sound-recording level is adjusted automatically. Auto level control will take effect automatically in response to the sound level.

- **Manual**

You can adjust the sound-recording level as needed.

Select **[Rec. level]** and press the < ◀ ▶ > keys while looking at the level meter to adjust the sound-recording level. Look at the peak hold indicator, and adjust so that the level meter sometimes lights up on the right of the "12" (-12 dB) mark for the loudest sounds. If it exceeds "0," the sound will be distorted.

- **Disable**

Sound will not be recorded.

## Wind Filter

---

Set to **[Enable]** for automatic reduction of audio distortion in windy outdoor scenes. Only activated when the camera's built-in microphone is used. When the wind filter function takes effect, part of the low bass sounds will also be reduced.

## Attenuator

---

This feature suppresses sound distortion caused by loud noises. Set to **[Enable]** if sound is distorted with **[Sound rec.]** set to **[Auto]** or **[Manual]**.





# Time-Lapse Movies

## [Approx. Time Available for Recording Time-Lapse Movies](#)

Still photos shot at a set interval can be stitched together automatically to create a 4K or Full HD time-lapse movie. A time-lapse movie shows how a subject changes in a much shorter period of time than the actual time it took. It is effective for a fixed-point observation of changing scenery, growing plants, celestial motion, etc.

**Time-lapse movies are recorded in MP4 format at the following quality:**  $\text{4K } 29.97\text{P [ALL-I]}$  (NTSC)/ $\text{4K } 25.00\text{P [ALL-I]}$  (PAL) in 4K recording, and  $\text{FHD } 29.97\text{P [ALL-I]}$  (NTSC)/ $\text{FHD } 25.00\text{P [ALL-I]}$  (PAL) in Full HD recording.

Note that the frame rate is updated automatically to match the  **Video system** setting ().

## 1. Select **Time-lapse movie**.

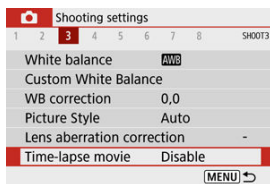

## 2. Select **[Time-lapse]**.

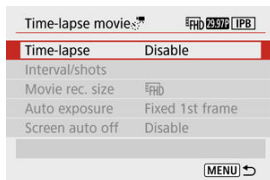

### 3. Select a scene.

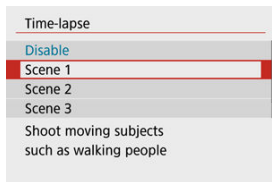

- Select a scene to suit the shooting situation.
- For greater freedom when setting the shooting interval and number of shots manually, select [**Custom**].

### 4. Set the shooting interval.

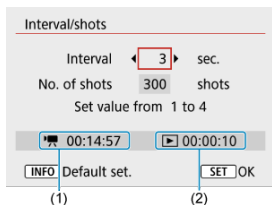

- Select [**Interval/shots**].
- Select [**Interval**] (sec.). Use the < ◀ ▶ > keys to set a value, then press the < [INFO] > button.
- Refer to [▶📷: **Time required**] (1) and [▶▶: **Playback time**] (2) as you set it.

#### When [**Custom**] is set

- Select [**Interval**] (min.:sec.).
- Press the < [INFO] > button to display < [▶] >.
- Use the < ▲ >< ▼ > keys to set a value, then press the < [INFO] > button. (Returns to < [ ] >.)
- Select [**OK**] to register the setting.

## 5. Set the number of shots.

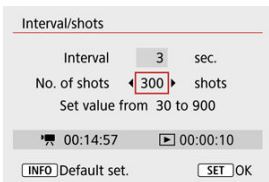

- Select [**No. of shots**]. Use the < ◀ ▶ > keys to set a value, then press the < (M) > button.
- Refer to [🕒: **Time required**] and [▶: **Playback time**] as you set the number.

### When [Custom] is set

- Select the digit.
- Press the < (M) > button to display < (M) >.
- Use the < ▲ > < ▼ > keys to set a value, then press the < (M) > button. (Returns to < □ >.)
- Make sure [▶: **Playback time**] is not displayed in red.
- Select [**OK**] to register the setting.

### ⚠ Caution

- [**Playback time**] is displayed in red if the card does not have enough free space for your specified number of shots. Although the camera can continue recording, the recording will stop when the card becomes full.
- [**Playback time**] is displayed in red if the [**No. of shots**] setting results in a file size exceeding 4 GB for a card not formatted in exFAT (🔗). If you keep recording in this condition and the movie file size reaches 4 GB, the time-lapse movie recording will stop.



#### Note

- With [Scene \*], available intervals and numbers of shots are restricted, to suit the type of scene.
- For details on cards that can record time-lapse movies, see [Card performance requirements \(movie recording\) \[write/read speed\]](#).
- If the number of shots is set to 3600, the time-lapse movie will be approx. 2 min. in NTSC and approx. 2 min. 24 sec. in PAL.

## 6. Select the desired movie recording size.

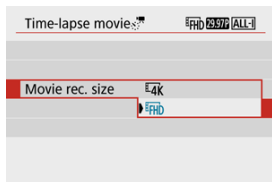

- **4K (3840 × 2160)**  
The movie is recorded in 4K quality. The aspect ratio is **16:9**.  
The frame rate is 29.97 fps (**29.97P**) for NTSC and 25.00 fps (**25.00P**) for PAL, and movies are recorded in MP4 (**MP4**) format with ALL-I (**[ALL-I]**) compression.
- **FHD (1920 × 1080)**  
The movie will be recorded in Full High-Definition (Full HD) quality. The aspect ratio is **16:9**.  
The frame rate is 29.97 fps (**29.97P**) for NTSC and 25.00 fps (**25.00P**) for PAL, and movies are recorded in MP4 (**MP4**) format with ALL-I (**[ALL-I]**) compression.

## 7. Set [Auto exposure].



- **Fixed 1st frame**

When taking the first shot, metering is performed to set the exposure automatically to match the brightness. The exposure setting for the first shot will be applied to subsequent shots. Other shooting-related settings for the first shot will also be applied for subsequent shots.

- **Each frame**

Metering is also performed for each subsequent shot to set the exposure automatically to match the brightness. Note that any functions such as Picture Style and white balance that are set to **[Auto]** will be set automatically for each subsequent shot.

 **Caution**

- Significant changes in brightness between shots may prevent the camera from shooting at the specified interval when **[Interval]** is set to 3 sec. or less and **[Auto exposure]** is set to **[Each frame]**.
- With **[Auto exposure]** set to **[Each frame]**, the ISO speed, shutter speed, and aperture value may not be recorded in the time-lapse movie Exif information in some shooting modes.

## 8. Set [Screen auto off].

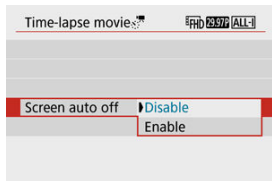

- **Disable**

Even during time-lapse movie recording, the image will be displayed. (The screen turns off only at the time of shooting.) Note that the screen will turn off when approx. 30 min. elapse after the shooting started.

- **Enable**

Note that the screen will turn off when approx. 10 sec. elapse after the shooting started.



### Note

- During time-lapse movie recording, you can press the < INFO > button to turn on/off the screen.

## 9. Set the beeper.

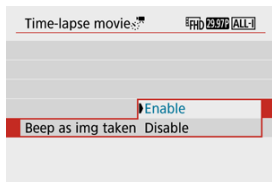

- Select [**Beep as img taken**].
- Set to [**Disable**] to prevent the camera from beeping for each shot.

## 10. Check the settings.

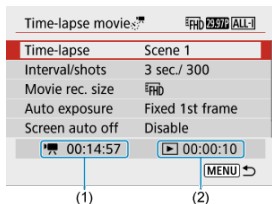

### (1) Time required

Indicates the time required to shoot the set number of shots with the set interval. If it exceeds 24 hours, "\*\*\*\* days" will be displayed.

### (2) Playback time

Indicates the movie recording time (time required to play back the movie) when creating the time-lapse movie in 4K movie or Full HD movie from the still photos taken with the set intervals.

## 11. Close the menu.

- Press the < MENU > button to turn off the menu screen.

## 12. Record the time-lapse movie.



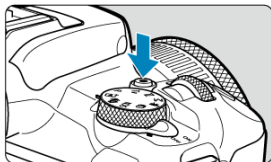

- Press the < INFO > button and check again the "Time required (1)" and "Interval (2)" displayed on the screen.



- Press the movie shooting button to start time-lapse movie recording.
- AF will not work during time-lapse movie recording.
- "●REC" is displayed in the upper right of the screen as the time-lapse movie is recorded.
- When the set number of shots are taken, the time-lapse movie recording ends.
- To cancel recording time-lapse movies, set [Time-lapse] to [Disable].



 **Caution**

- Do not point the camera toward an intense light source, such as the sun or an intense artificial light source. Doing so may damage the image sensor or the camera's internal components.
-  **Time-lapse movie** cannot be set to an option other than **[Disable]** when the camera is connected to a computer with the interface cable, or when an HDMI cable is connected.
- Movie Servo AF will not function.
- If the shutter speed is 1/30 sec. or slower, the exposure of the movie may not be displayed properly (may differ from that of the resulting movie).
- Do not zoom the lens during time-lapse movie recording. Zooming the lens may cause the image to be out of focus, the exposure to change, or the lens aberration correction not to function properly.
- Recording time-lapse movies under flickering light may cause noticeable screen flickering, and images may be captured with horizontal stripes (noise) or irregular exposure.
- Images displayed as time-lapse movies are recorded may look different from the resulting movie (in details such as inconsistent brightness from flickering light sources, or noise from a high ISO speed).
- When recording a time-lapse movie under low light, the image displayed during shooting may look different from what is actually recorded in the movie.
- If you move the camera from left to right (panning) or shoot a moving subject during time-lapse movie recording, the image may look extremely distorted.
- During time-lapse movie recording, auto power off will not take effect. Also, you cannot adjust the shooting function and menu function settings, play back images, etc.
- Sound is not recorded for time-lapse movies.
- The camera may not shoot if the shutter speed nearly coincides with the shooting interval.
- If the next scheduled shot is not possible, it will be skipped. This may shorten the recording time of the created time-lapse movie.
- If the time it takes to record to the card exceeds the shooting interval due to the shooting functions set or card performance, some of the shots may not be taken with the set intervals.
- The captured images are not recorded as still photos. Even if you cancel the time-lapse movie recording after only one shot is taken, it will be recorded as a movie file.
- Set  **Time-lapse movie** to **[Disable]** if you will connect the camera to a computer with the interface cable and use EOS Utility (EOS software). Options other than **[Disable]** will prevent the camera from communicating with the computer.

- During time-lapse movie recording, the lens's Image Stabilizer will not operate.
- Time-lapse movie recording ends if the power switch is set to < OFF >, and the setting changes to [Disable].
- Even if a flash is used, it will not fire.
- The following operations cancel standby for time-lapse movie recording and switch the setting to [Disable].
  - Selecting [Basic settings] in [🔧: Reset camera]
  - Using the Mode dial
- If you start time-lapse movie recording while the white [🔥] (🔋) icon is displayed, the image quality of the time-lapse movie may deteriorate. It is recommended that you start time-lapse movie recording after the white [🔥] icon disappears (camera's internal temperature decreases).



#### Note

- Using a tripod is recommended.
- Taking test shots in advance is recommended.
- The movie's field of view coverage for both the 4K and Full HD time-lapse movie recording is approx. 100%.
- To cancel time-lapse movie recording in progress, press the movie shooting button. The time-lapse movie shot so far will be recorded on the card.
- If the time required for recording is more than 24 hours but not more than 48 hours, "2 days" will be indicated. If three or more days are required, the number of days will be indicated in 24-hour increments.
- Even if the time-lapse movie's playback time is less than 1 sec., a movie file will still be created. In this case, "00'00"" is indicated in [Playback time].
- If the recording time is long, using the household power outlet accessories (sold separately) is recommended.
- YCbCr 4:2:0 (8-bit) color sampling and the BT.709 color space are used for 4K/Full HD time-lapse movies.

## Note

You can use Wireless Remote Control BR-E1 (sold separately) to start and stop the time-lapse movie recording. Prepare by setting [: Remote control] to [Enable].

### ● With Wireless Remote Control BR-E1

- First, pair the BR-E1 with the camera ().

Camera Status/ Remote Control Setting	<  > (Immediate Release) <2> (2-sec. Delay)	<  > (Movie Recording)
Recording standby	As set in the <a href="#">Shutter Button Function for Movies</a> setting	Starts recording
During time-lapse movie recording		Ends recording

## Approx. Time Available for Recording Time-Lapse Movies

For guidelines on how long you can record time-lapse movies (until the battery runs out), see [Available operating time](#).

# Movie Servo AF

---

With this function enabled, the camera focuses on the subject continuously during movie recording.

---

1. Select [📷: Movie Servo AF].

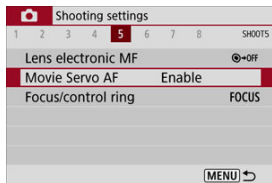

## 2. Select [Enable].

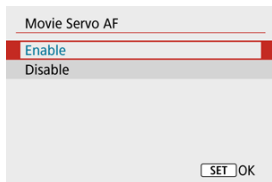

### ● With [Enable] set

- The camera focuses on the subject continuously even when you are not pressing the shutter button halfway.
- To keep the focus at a specific position, or if you prefer not to record mechanical sounds from the lens, you can temporarily stop Movie Servo AF by pressing the button assigned to [**Pause Movie Servo AF**] in [**☛: Custom Functions(C.Fn)**] (☑).
- When Movie Servo AF is paused, if you return to movie recording after operations such as pressing the < MENU > or < ▶ > button or changing the AF method, Movie Servo AF will resume.

### ● With [Disable] set

- Press the shutter button halfway to focus.

 Caution

**Precautions when set to [Movie Servo AF: Enable]**

- **Shooting conditions that make focusing difficult**
  - A fast-moving subject approaching or moving away from the camera.
  - A subject moving at a close distance to the camera.
  - When recording with a higher aperture value.
  - Also see [Shooting Conditions That Make Focusing Difficult](#).
- Since the lens is driven continuously and the battery power is consumed, the possible movie recording time (🕒) will be shortened.
- The camera's built-in microphone will also record mechanical sounds of the lens or sounds of camera/lens operations if AF operations are performed or the camera is operated during movie recording. In this case, using an external microphone may reduce these sounds. If the sounds are still distracting with an external microphone, it may be more effective to remove the external microphone from the camera and position it away from the camera and lens.
- Movie Servo AF will pause during zooming or magnified view.
- During movie recording, if a subject approaches or moves away or if the camera is moved vertically or horizontally (panning), the recorded movie image may momentarily expand or contract (change in image magnification).

# Digital Zoom

With the recording size set to [FHD 29.97P]/[FHD 23.98P] (NTSC) or [FHD 25.00P] (PAL), you can shoot with approx. 3–10× digital zoom.

## 1. Select [📷: Digital zoom].

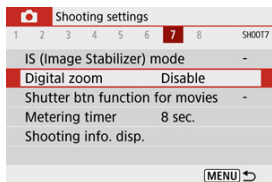

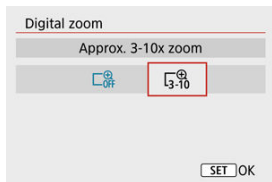

## 2. Select an option.

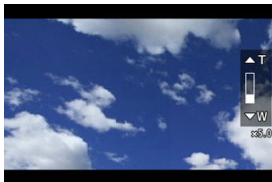

- Select the amount to zoom, then press the <  > button.
- Press the < MENU > button to close the menu.

### 3. Use digital zoom.



- Press the <  > button.
- The digital zoom bar will appear.
- Press the < ▲ > key to zoom in or press the < ▼ > key to zoom out.
- Pressing the shutter button halfway focuses with [**1-point AF**] (fixed at center).
- To cancel digital zoom, select [**Disable**] in step 2.

#### Caution

- Using a tripod to prevent camera shake is recommended.
- Time-lapse movies, miniature effect movies, and Movie digital IS are not available.
- The maximum ISO speed will be ISO 6400.
- A magnified view is not available.
- Since Movie digital zoom processes the image digitally, the image will look grainier at higher magnifications. Noise, dots of light, etc. may also become noticeable.
- The scene icon will not be displayed.
- Also see [Shooting Conditions That Make Focusing Difficult](#).



## Shutter Button Function for Movies

---

You can set the functions performed by pressing the shutter button halfway or completely during movie recording.

---

1. Select [📷: Shutter btn function for movies].

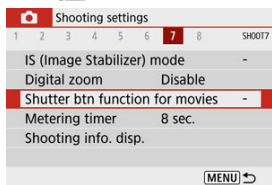

## 2. Select an option.

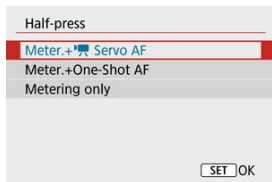

- **Half-press**  
Specify the function performed by pressing the shutter button halfway.
- **Fully-press**  
Displayed with the Mode dial set to <M>. Specify the function performed by pressing the shutter button completely.

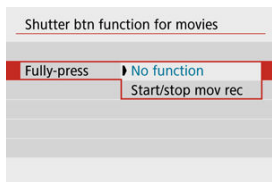

With **[Fully-press]** set to **[Start/stop mov rec]**, you can start/stop movie recording by pressing the movie shooting button, by pressing the shutter button completely, or by using Wireless Remote Control BR-E1 or Remote Switch RS-60E3 (both sold separately).

### Note

- If **[Half-press]** is set to **[Meter.+One-Shot AF]**, it is changed to **[Meter.+ Servo AF]** if you set **[Movie rec. size]** to **[4K]**.

# Movie Self-Timer

---

Movie recording can be started by the self-timer.

---

## 1. Select [📷: Movie self-timer].

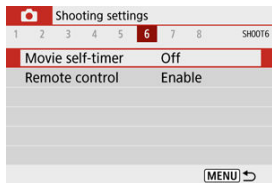

## 2. Select an option.

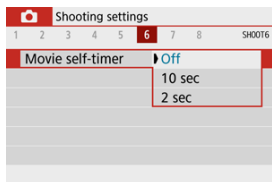

## 3. Record the movie.

- After you press the movie shooting button, the camera beeps and displays the number of seconds left before recording.

### Note

- To cancel the self-timer, press the <  > button.

# Movie Digital IS

---

The camera's Movie digital IS feature reduces camera shake as movies are recorded. Movie digital IS can provide effective stabilization even when your lens is not equipped with Image Stabilizer. When using a lens equipped with Image Stabilizer, set the lens's Image Stabilizer switch to < ON >.

---

1. Select [📷: IS (Image Stabilizer) mode].

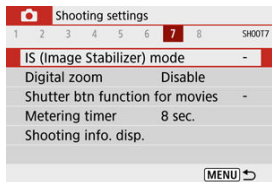

2. Select [📷 Digital IS].

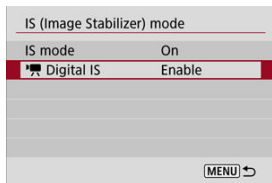

### 3. Select an option.

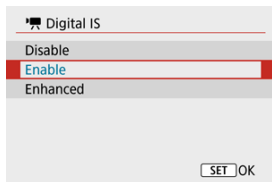

- **Disable** (OFF)  
Image stabilization with Movie digital IS is disabled.
- **Enable** (ON)  
Camera shake will be corrected. The image will be slightly magnified.
- **Enhanced** (ON+)  
Compared to when [Enable] is set, stronger camera shake can be corrected. The image will be more magnified.

#### Caution

- Movie digital IS will not function when the lens's optical Image Stabilizer switch is set to <OFF>.
- Movie digital IS is not available when the camera is set to use Movie digital zoom or record time-lapse movies.
- The wider the angle of view, the more effective the image stabilization will be. The narrower the angle of view, the less effective the image stabilization will be.
- Consider setting to [Disable] when using TS-E or fish-eye lenses.
- Effects of Movie digital IS are not applied to images during magnified display.
- Since Movie digital IS magnifies the image, the image looks more grainy. Noise, dots of light, etc. may also become noticeable.
- Depending on the subject and shooting conditions, the subject may blur noticeably (the subject momentarily looks out of focus) due to the effects of the Movie digital IS.
- When Movie digital IS is set, the size of AF points will also change.
- When using a tripod, setting Movie digital IS to [Disable] is recommended.
- This feature is not compatible with certain lenses. For details, refer to the Canon website.

## Miniature Effect Movies





---

By blurring image areas outside a selected area, you can record movies with a miniature model effect applied. You can also choose a playback speed before recording to create movies that resemble miniature scenes with people and objects moving in fast motion. Note that sound is not recorded.

---

### 1. Select [OFF].



- Press the <  > button, and on the Quick Control screen, select [OFF].
- Select [5x], [10x], or [20x] as the playback speed.

## 2. Move the scene frame.

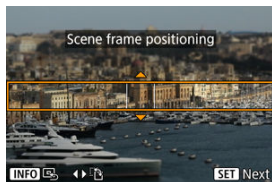

- Use the scene frame to set an area that will look sharp.
- Press the  $\langle \text{INFO} \rangle$  button to enable movement of the scene frame, which turns orange.
- To switch the scene frame orientation, use the  $\langle \blacktriangleleft \blacktriangleright \blacktriangleright \blacktriangleleft \rangle$  keys when it is in horizontal orientation or the  $\langle \blacktriangle \blacktriangledown \blacktriangledown \blacktriangle \rangle$  keys when it is in vertical orientation.
- To move a horizontal scene frame, press the  $\langle \blacktriangle \blacktriangledown \blacktriangledown \blacktriangle \rangle$  keys, and to move a vertical scene frame, press the  $\langle \blacktriangleleft \blacktriangleright \blacktriangleright \blacktriangleleft \rangle$  keys.
- To center the scene frame again, press the  $\langle \text{INFO} \rangle$  button.
- To confirm the position of the scene frame, press the  $\langle \text{SET} \rangle$  button. Next, set the AF point.

## 3. Move the AF point.



- The AF point turns orange and can be moved.
- Press the  $\langle \blacktriangle \blacktriangledown \blacktriangledown \blacktriangle \blacktriangleleft \blacktriangleright \blacktriangleright \blacktriangleleft \rangle$  keys to move the AF point to the position to focus on.
- Aligning the AF point and scene frame is recommended.
- To return the AF point to the center of the screen, press the  $\langle \text{INFO} \rangle$  button.
- To confirm the position of the AF point, press the  $\langle \text{SET} \rangle$  button.



## 4. Record the movie.

- Press the movie shooting button.

### Speed and playback time (for a 1-minute movie)

Speed	Playback Time
5x	Approx. 12 sec.
10x	Approx. 6 sec.
20x	Approx. 3 sec.

#### Caution

- To make people and objects in the scene move quickly during playback, select , , or  before recording the movie. Movies will resemble scenes in a miniature model.
- Sound is not recorded.



## Other Menu Functions

---

  [1]

  [2]

  [3]

  [4]

  [5]

  [6]

  [7]

  [8]



- **Shooting mode**

Available options include autoexposure and manual exposure movie recording.



- **Exposure comp.**

Exposure compensation can be adjusted in a range of  $\pm 3$  stops, in 1/3-stop increments. For details on exposure compensation, see [Exposure Compensation](#).

- **ISO speed settings**

- **ISO speed**

In [M] mode, you can set the ISO speed manually. You can also select ISO Auto.

- **Max for Auto**

You can set the maximum limit for ISO Auto in movie recording in [M] mode or in [M] mode with ISO Auto.

[H(25600)] is added as an option in [Max for Auto] when [1: ISO expansion] in [F: Custom Functions(C.Fn)] is set to [1:Enable].

- **Auto Lighting Optimizer**

Brightness and contrast can be corrected automatically. For details on Auto Lighting Optimizer, see [Auto Lighting Optimizer](#).

- **Highlight tone priority**

You can reduce overexposed, clipped highlights as you record movies. For details on Highlight tone priority, see [Highlight Tone Priority](#).

 **Caution**

- [Enhanced] is not available (not displayed) when recording movies with [Camera icon]: Highlight tone priority] set.

## ● Auto slow shutter

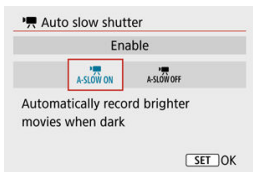

You can choose whether to record movies that are brighter than when set to **[Disable]** by automatically slowing the shutter speed under low light.

Available in  recording mode. Applies when the frame rate of the movie recording size is **59.94P** or **50.00P**.

- **Disable**

Enables you to record movies with smoother, more natural movement, less affected by subject shake than when set to **[Enable]**. Note that under low light, movies may be darker than when set to **[Enable]**.

- **Enable**

Enables you to record brighter movies than when set to **[Disable]** by automatically reducing the shutter speed to 1/30 sec. (NTSC) or 1/25 sec. (PAL) under low light.

### Note

- Setting to **[Disable]** is recommended when recording moving subjects under low light, or when afterimages such as trails may occur.

## [📷3]

---

- **White balance**

For details on white balance, see [White Balance Settings](#).

- **Custom White Balance**

For details on custom white balance, see [] [Custom White Balance](#).

- **WB correction**

For details on white balance correction, see [White Balance Correction](#).

- **Picture Style**

For details on Picture Styles, see [Picture Style Selection](#).

- **Lens aberration correction**

For details on lens aberration correction, see [Lens Aberration Correction](#).

## [📷4]

---

- **AF method**

For details on AF methods, see [AF Method](#).

- **Eye detection**

For details on eye detection, see [Eye Detection](#).

- **Focus mode**

For details on focus modes, see [Focus Mode](#).

- **MF peaking settings**

For details on MF peaking settings, see [MF Peaking Settings \(Outline Emphasis\)](#).

## [📷5]

---

- **Lens electronic MF**

For details on lens electronic MF, see [Lens Electronic MF](#).

## [📷6]

---

- **Remote control**

By setting to [**Enable**], you can start or stop movie recording using Wireless Remote Control BR-E1 (sold separately). First, pair the BR-E1 with the camera ([🔗](#)).

### **With Wireless Remote Control BR-E1**

For normal movie recording, set the release timing/movie shooting switch to <  >, then press the release button.

For time-lapse movie recording, see [Time-Lapse Movies](#).

## [📷7]

---

- **IS (Image Stabilizer) mode**

For details on configuring image stabilization, see [Image Stabilizer \(IS Mode\)](#).

- **Metering timer**

For details on the metering timer, see [Metering Timer](#).

- **Shooting info. disp.**

For details on configuring shooting information display, see [Shooting Information Display](#).

- **VF display format**

For details on the viewfinder display format, see [Viewfinder Display Format](#).

- **HDMI info disp**

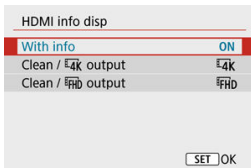

You can configure information display for image output via an HDMI cable.

- **With info**

The image, shooting information, AF points, and other information is shown on the other device via HDMI. Note that the camera screen goes off. Recorded movies are saved to the card.

- **Clean / 4K output**

HDMI output consists solely of 4K movies. Shooting information and AF points are also displayed on the camera, but no image is recorded to the card. Note that Wi-Fi communication is not available.

- **Clean / FHD output**

HDMI output consists solely of Full HD movies. Shooting information and AF points are also displayed on the camera, but no image is recorded to the card. Note that Wi-Fi communication is not available.





## General Movie Recording Precautions

### Caution

#### Precautions for movie recording

- Do not point the camera toward an intense light source, such as the sun or an intense artificial light source. Doing so may damage the image sensor or the camera's internal components.
- If you record something that has fine detail, moire or false colors may result.
- White balance may change if the ISO speed or aperture value changes during movie recording when [AWB] or [AWBW] is set.
- Recording movies under fluorescent or LED lighting may cause the screen to flicker.
- Autofocusing with a USM lens during movie recording under low light may cause horizontal banding to be recorded in movies. The same type of noise may occur if you focus manually (MF) with certain lenses equipped with an electronic focusing ring.
- Recording a few test movies is recommended if you intend to perform zooming during movie recording. Zooming as you record movies may cause exposure changes or lens sounds to be recorded, an uneven audio level, or loss of focus.
- Large aperture values may delay or prevent accurate focusing.
- Performing AF during movie recording may cause the following kinds of issues: significant temporary loss of focus, recording of changes in movie brightness, temporary stopping of movie recording, or recording of mechanical lens sounds.
- Avoid covering the built-in microphones () with your fingers or other objects.
- Also see [General Still Photo Shooting Precautions](#), as needed.
- The camera may become hot in movie recording while connected via Wi-Fi. Use a tripod or take other measures to avoid handheld recording.

#### Red internal temperature warning icon

- If the camera's internal temperature increases due to prolonged movie recording or under a high ambient temperature, a red  icon will appear.
- The red  icon indicates that movie recording will soon end automatically. If this happens, you will not be able to record again until the camera's internal temperature decreases, so turn off the power and let the camera cool down a while. Note that the time until movie recording stops automatically when the red  icon is displayed varies depending on shooting conditions.
- Recording a movie at a high temperature for a prolonged period will cause the red  icon to appear earlier. When you are not recording, always turn off the camera.

## Recording and image quality

- If the attached lens has an Image Stabilizer and you set the Image Stabilizer switch to < ON >, the Image Stabilizer will operate at all times even if you do not press the shutter button halfway. This will consume battery power, and it may reduce the total movie recording time under some shooting conditions. When the Image Stabilizer is not necessary, such as when using a tripod, it is recommended that you set the Image Stabilizer switch to < OFF >.
- If the brightness changes as you record a movie with auto exposure, the movie may appear to stop momentarily. In this case, record movies with manual exposure.
- If there is a very bright light source in the image, the bright area may appear black on the screen. Movies are recorded almost exactly as they appear on the screen.
- Image quality may be lower when recording movies under a combination of conditions such as high ISO speeds, high temperatures, low shutter speeds, and low light.
- Recording movies over an extended period may cause the camera's internal temperature to rise and affect image quality. Turn off the camera when possible if you are not recording movies.
- Video and audio quality of recorded movies may be worse on other devices, and playback may not be possible, even if the devices support MP4 formats.
- If you use a card with a slow writing speed, an indicator may appear on the right of the screen during movie recording. The indicator shows how much data has not yet been written to the card (remaining capacity of the internal buffer memory), and with slower cards, it increases more quickly. If the indicator (1) becomes full, movie recording will stop automatically.



(1)



- With cards that have fast writing speeds, the indicator will not appear, or the level (if displayed) will not increase much. First, record a few test movies to see if the card can write fast enough.
- If the indicator shows that the card is full, and movie recording stops automatically, sound near the end of the movie may not be recorded properly.
- If the card's writing speed is slow (due to fragmentation) and the indicator appears, formatting the card may make the writing speed faster.

## Audio restrictions

- Note that the following restrictions apply to audio in movie recording.
  - Sound will not be recorded for approx. the last two frames.
  - When you play back movies in Windows, movie images and sound may become slightly out of synchronization.



 **Note****Notes for movie recording**

- Each time you record a movie, a new movie file is created on the card.
- The movie's field of view coverage for recording 4K, Full HD, and HD movies is approx. 100%.
- To enable starting/stopping movie recording by pressing the shutter button completely, set [**Fully-press**] for [: **Shutter btn function for movies**] to [**Start/stop mov rec**].
- The built-in microphone () records in mono.
- Any connected external microphone is used instead of the built-in microphone.
- Most external microphones compatible with 3.5 mm mini-jacks can be used.
- Focus preset during movie recording is available when using (super) telephoto lenses equipped with this function released in and after the second half of 2011.
- YCbCr 4:2:0 (8-bit) color sampling and the BT.709 color space are used for 4K, Full HD, and HD movies.

# Playback

---

This chapter covers topics related to playback—playing back captured still photos and movies—and introduces menu settings on the playback ([▶]) tab.

## Caution

- Normal display or selection on this camera may not be possible for images captured on other cameras, or images from this camera that have been edited or renamed on a computer.
- Images that cannot be used with playback functions may be displayed.

- [Tab Menus: Playback](#)
- [Image Playback](#)
- [Index Display \(Multiple-Image Display\)](#)
- [Magnified Image Display](#)
- [Movie Playback](#)
- [Editing a Movie's First and Last Scenes](#)
- [Frame Extraction from 4K Movies or 4K Time-Lapse Movies](#)
- [Digest Movie Editing](#)
- [Playback on a TV Set](#)
- [Protecting Images](#)
- [Erasing Images](#)
- [Rotating Still Photos](#)
- [Changing Movie Orientation Information](#)
- [Rating Images](#)
- [Print Ordering \(DPOF\)](#)
- [Photobook Set-up](#)
- [Creative Assist](#)
- [Creative Filters](#)
- [Red-Eye Correction](#)
- [Resizing](#)
- [Cropping](#)
- [Slide Show](#)
- [Setting Image Search Conditions](#)
- [Resuming from Previous Playback](#)
- [Browsing Images with the Dial](#)
- [Playback Information Display](#)
- [AF Point Display](#)
- [HDMI HDR Output](#)

## Tab Menus: Playback

---

### ● Playback 1

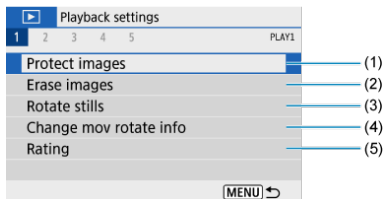

- (1) [Protect images](#)
- (2) [Erase images](#)
- (3) [Rotate stills](#)
- (4) [Change mov rotate info](#)
- (5) [Rating](#)

### ● Playback 2

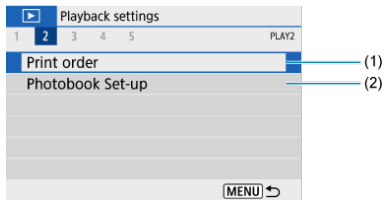

- (1) [Print order](#)
- (2) [Photobook Set-up](#)

### ● Playback 3

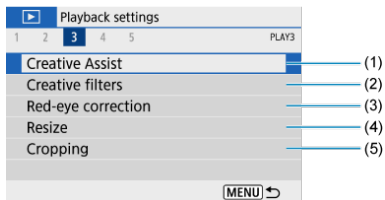

- (1) [Creative Assist](#)
- (2) [Creative filters](#)
- (3) [Red-eye correction](#)
- (4) [Resize](#)
- (5) [Cropping](#)

### ● Playback 4

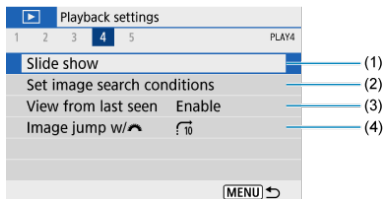

- (1) [Slide show](#)
- (2) [Set image search conditions](#)
- (3) [View from last seen](#)
- (4) [Image jump w/](#) 

## ● Playback 5

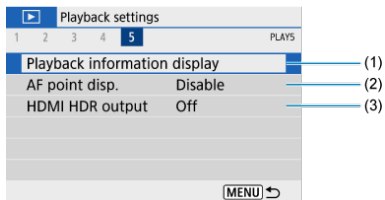

- (1) [Playback information display](#)
- (2) [AF point disp.](#)
- (3) [HDMI HDR output](#)

# Image Playback

---

[Single-Image Display](#)

[Shooting Information Display](#)

## Single-Image Display

---

### 1. Switch to playback.



- Press the  button.
- The last image captured or played back is displayed.

## 2. Browse images.

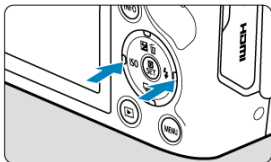



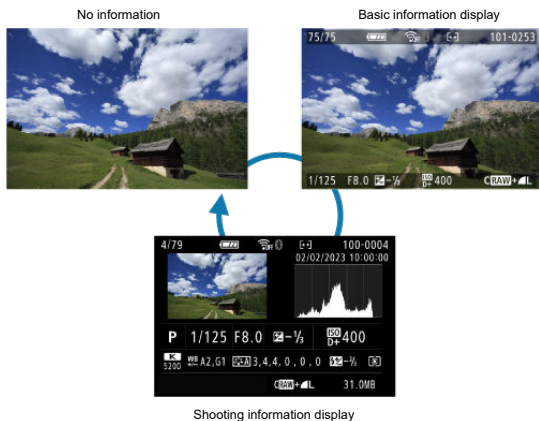

- To play back images starting with the most recent, press the < ◀ > key. To play back images starting with the first captured image, press the < ▶ > key.
- Each time you press the < INFO > button, the display will change.



## 3. Exit image playback.



- Press the < ▶ > button to exit image playback and return to shooting standby.

#### Note

- Lines indicating the image area are shown on RAW images captured with [: **Still img aspect ratio**] set to an option other than [3:2] ().
- If the search conditions are set with [: **Set image search conditions**] (), only the filtered images will be displayed.

## Shooting Information Display

---

With the shooting information screen displayed () , you can press the < INFO > button to change the information displayed at the bottom of the screen. You can also customize the information displayed, in [: **Playback information display**] ().





## Index Display (Multiple-Image Display)

---

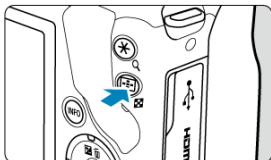
### 1. Switch to the index display.



- During image playback, press the <  > button.
- The 4-image index display will appear. The selected image is highlighted with an orange frame. Pressing the <  > button again switches display from 9 images to 36, and then to 100. Pressing the <  > button switches display from 100 images to 36, 9, 4, and then single-image display.

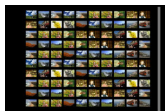
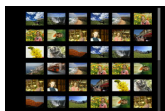
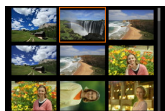
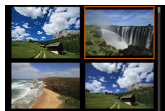

## 2. Browse images.

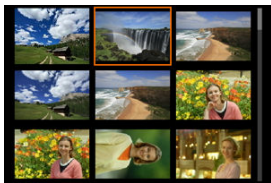

- Press the < ▲ >< ▼ >< ◀ >< ▶ > keys to move the orange frame for image selection.
- Press the < (Ⓜ) > button in index display to show the selected image in single-image display.

## Magnified Image Display

---

### 1. Magnify the image.

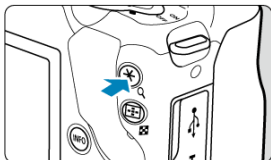

- During image playback, press the <Q> button.



(1)

- The magnified view will appear. The magnified area position (1) will be displayed in the lower right of the screen.
- Each press of the <Q> button magnifies display.
- Each press of the <[checkered]> button reduces display. For index display ([checkered]), press the <[checkered]> button again after the final reduction.

## 2. Scroll the image.

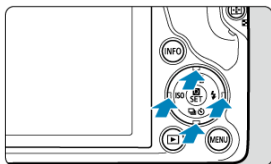

- Press the < ▲ >< ▼ >< ◀ >< ▶ > keys to scroll around the image.
- Press the < ◻▶ > or < MENU > button to exit magnified view.

# Movie Playback

---

## 1. Switch to playback.



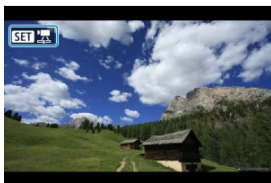

- Press the <  > button.

## 2. Select a movie.

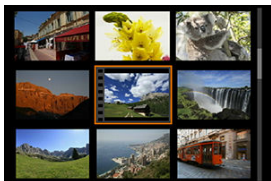

- Use the < ◀ ▶ > keys to select a movie to play.
- In single-image display, the [SET ] icon displayed in the upper left of the screen indicates a movie.





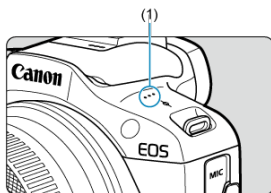

- In index display, perforations at the left edge of a thumbnail indicate a movie. Movies cannot be played from index display, so press the <  > button to switch to single-image display.

3. In single-image display, press the  button.



























4. Select .



(1) Speaker























- The movie will start playing back.
- You can pause playback and access the movie playback panel by pressing the  button. Press it again to resume the playback.
- Pressing the  key skips forward approx. 4 sec. during playback. Similarly, pressing the  key skips back approx. 4 sec.
- Use the  <  keys to adjust the volume (even during playback).

## Movie playback panel



Item	Playback Operations
 <b>Play</b>	Pressing the <  > button toggles between playing movies and stopping playback.
 <b>Slow motion</b>	Adjust the slow motion speed with the <  >>  > keys. The slow motion speed is indicated in the upper right of the screen.
 <b>Skip backward</b>	Skips backward approx. 4 sec. each time you press the <  > button.
 <b>Previous frame</b>	Displays the previous frame each time you press the <  > button. Holding down the <  > button rewinds the movie.
 <b>Next frame</b>	Plays the movie frame-by-frame each time you press the <  > button. Holding down the <  > button fast-forwards the movie.
 <b>Skip forward</b>	Skips forward approx. 4 sec. each time you press the <  > button.
 <b>Edit</b>	Displays the editing screen (  ).
 <b>Frame Grab</b>	Available when you play 4K or 4K time-lapse movies. Enables you to extract the current frame and save it as a JPEG still image (  ).
 <b>Background music</b>	Plays back a movie with the selected background music (  ).
	Playback position
mm' ss"	Playback time (minutes:seconds)
 <b>Volume</b>	Use the <  >>  > keys to adjust the speaker volume (  ).





## Digest movie playback panel

Item	Playback Operations
 <b>Play</b>	Pressing the <  > button toggles between playing movies and stopping playback.
 <b>Slow motion</b>	Adjust the slow motion speed with the <  ><  > keys. The slow motion speed is indicated in the upper right of the screen.
 <b>Previous clip</b>	Displays the first frame of the previous clip.
 <b>Previous frame</b>	Displays the previous frame each time you press the <  > button. Holding down the <  > button rewinds the movie.
 <b>Next frame</b>	Plays the movie frame-by-frame each time you press the <  > button. Holding down the <  > button fast-forwards the movie.
 <b>Next clip</b>	Displays the first frame of the next clip.
 <b>Erase clip</b>	Erases the current clip.
 <b>Edit</b>	Displays the editing screen (  ).
 <b>Background music</b>	Plays back a movie with the selected background music (  ).
	Playback position
mm' ss"	Playback time (minutes:seconds)
 <b>Volume</b>	Use the <  ><  > keys to adjust the speaker volume (  ).

### Caution

- Adjust the volume using television controls when the camera is connected to a television for movie playback () , because volume cannot be adjusted with the <  ><  > keys.
- Movie playback may stop if the card's read speed is too slow or movie files have corrupted frames.

### Note

- To skip back or forward to the beginning of the previous or next clip during digest movie playback, press the <  ><  > keys.

## Editing a Movie's First and Last Scenes

---

1. In single-image display, press the < [⏪] > button.

2. Select [▶].

- Movie playback begins.

3. Press the < [⏸] > button to pause the movie.

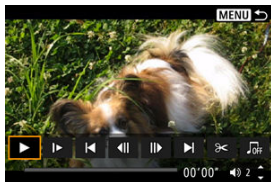

4. On the movie playback panel, select [⏮].

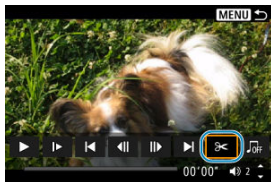

## 5. Specify the part to be edited out.

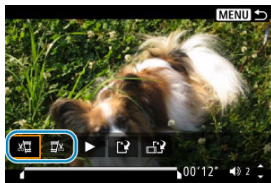

- Select either [Cut beginning] or [Cut end].

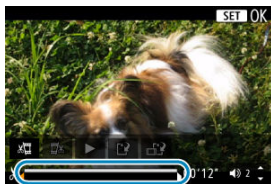

- Press the <<>>> keys to go back or forward one frame (or video snapshot) at a time. Keep holding down the <>> key to fast forward.
- After deciding which part to edit out, press the <SET OK> button. The portion indicated by a line at the bottom of the screen will remain.

## 6. Check the edited movie.

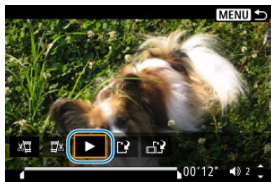

- Select [Play] to play back the edited movie.
- To change the edited part, go back to step 5.
- To cancel the editing, press the <MENU> button.

## 7. Save.

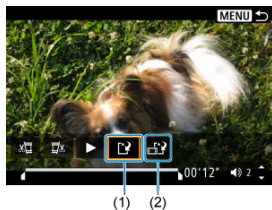

- Select [(1)] (1).
- The save screen will appear.
- To save it as a new file, select [**New file**], or to save it and overwrite the original movie file, select [**Overwrite**].
- Select [(2)] (2) to save a compressed version of the file. 4K movies are converted to Full HD movies before compression.
- On the confirmation screen, select [**OK**] to save the edited movie and return to the movie playback screen.

### ⚠ Caution

- Because editing is performed in approx. 1 sec. increments (at the position indicated by [⏸] at the bottom of the screen), the actual position where movies are trimmed may differ from your specified position.
- Movies shot with another camera cannot be edited with this camera.
- You cannot edit a movie when the camera is connected to a computer.
- [(2)] is not available for movies created with [**Save compressed version**], because further compression and saving is not possible.

# Frame Extraction from 4K Movies or 4K Time-Lapse Movies

---

From 4K or 4K time-lapse movies, you can select individual frames to save as JPEG still images. This is referred to as “frame grabbing.”



---

## 1. Switch to playback.

- Press the <  > button.

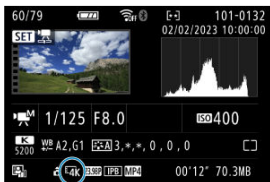
## 2. Select a 4K movie or 4K time-lapse movie.



- Use the < ◀ ▶ > keys for selection.
- On the shooting information screen () , 4K movies and 4K time-lapse movies are indicated by a [4K] icon.
- In index display, press the <  > button to switch to single-image display.

## 3. In single-image display, press the < > button.

## 4. Select [].

- The movie will start playing back.

5. Press the <  > button to pause the movie.

- The movie playback panel will appear.

6. Select a frame to grab.



- Use the movie playback panel to select the frame to grab as a still image.
- For movie playback panel instructions, see [Movie Playback Panel](#).

7. Select .



## 8. Save.



- Select **[OK]** to save the current frame as a JPEG still image.

## 9. Select the image to display.

- Check the destination folder and image file number.
- Select **[View original movie]** or **[View extracted still image]**.

### ⚠ Caution

- Frame grabbing is not possible with Full HD movies, Full HD time-lapse movies, HD movies, or with 4K movies or 4K time-lapse movies from a different camera.

## Digest Movie Editing

---

Individual chapters (clips) recorded in <  > mode can be erased. Be careful when erasing clips, because they cannot be recovered.



---

### 1. Switch to playback.

- Press the <  > button.

### 2. Select a digest movie.



- Use the < ◀ ▶ > keys to select a digest movie.
- In single-image display, digest movies are labeled with [  ] in the upper left.
- In index display, press the <  > button to switch to single-image display.

### 3. In single-image display, press the < > button.



4. Select [📺].



- Digest movie playback begins.

5. Press the <⏸> button to pause the digest movie.

- The movie playback panel will appear.

6. Select a clip.



- Use [⏮] or [⏭] to select a clip.

7. Select [🔍].



8. Select [OK].

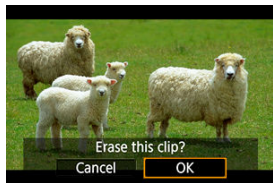

- The clip is erased, and the digest movie is overwritten.



**Note**

- For other instructions on using the movie playback panel for digest movies, see [Digest movie playback panel](#).

## Playback on a TV Set

---

You can view your shots and movies on a TV by connecting the camera to a TV with a commercially available HDMI cable.

If the image does not appear on the TV screen, confirm that [**☛**: Video system] is correctly set to [**For NTSC**] or [**For PAL**] (depending on the video system of your television).

---

1. Connect the HDMI cable to the camera.

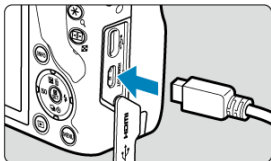

- Insert the cable plug in the < **HDMI** > terminal.

2. Connect the HDMI cable to the television.

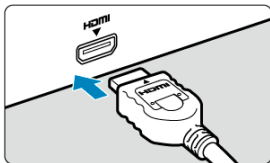

- Connect the HDMI cable to the television's HDMI IN port.

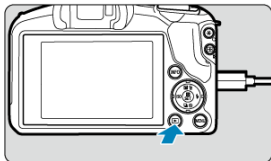

3. Turn on the television and switch the television's video input to select the connected port.
4. Set the camera's power switch to < **ON** >.

5. Press the <  > button.



- Images are now displayed on the television, with nothing displayed on the camera screen.
- The images will automatically be displayed at the optimum resolution matching the connected television.

 **Caution**

- Adjust movie sound volume with the television. The sound volume cannot be adjusted with the camera.
- Before connecting or disconnecting the cable between the camera and television, turn off the camera and television.
- Depending on the television, part of the image displayed may be cut off.
- Do not connect any other device's output to the camera's < **HDMI** > terminal. Doing so may cause a malfunction.
- Certain televisions may not display the images due to incompatibility.
- It may take some time before images are displayed. To avoid delay, set [: **HDMI resolution**] to [1080p] ().

# Protecting Images

---

- [Protecting a Single Image](#)
- [Specifying the Range of Images to Protect](#)
- [Protecting All Images in a Folder or on a Card](#)

You can protect important images from being accidentally erased.

---

## Protecting a Single Image

---

1. Select [: Protect images].

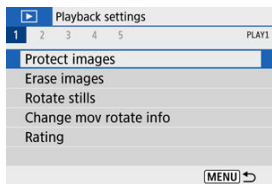

2. Select [Select images].

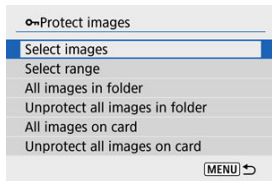





3. Select an image.

- Use the < ◀ ▶ > keys to select an image to protect.

#### 4. Protect the image.



- Press the <  > button to protect the selected image, after which it will be labeled with a <  > icon (1) at the top of the screen.
- To cancel protection and clear the <  > icon, press the <  > button again.
- To protect another image, repeat steps 3 and 4.

## Specifying the Range of Images to Protect

While looking at the images in the index display, you can specify the first and last images for a range to protect all the specified images at once.

### 1. Select [Select range].

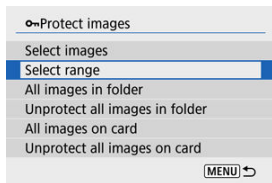

- Select [Select range] in []: Protect images].

### 2. Specify the range of images.



- Select the first image (start point).
- Next, select the last image (end point). The images in the specified range will be protected and the < On > icon will appear.
- To select another image to protect, repeat step 2.

## Protecting All Images in a Folder or on a Card

You can protect all the images in a folder or on a card at once.

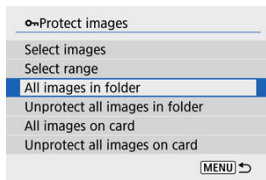

- When you select **[All images in folder]** or **[All images on card]** in **[ ]: Protect images**, all the images in the folder or on the card will be protected.
- To cancel protection, select **[Unprotect all images in folder]** or **[Unprotect all images on card]**.
- If the search conditions are set with **[ ]: Set image search conditions** (🔍), the display will change to **[All found images]** and **[Unprotect all found]**.

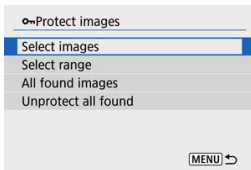

- If you select **[All found images]**, all the images filtered by the search conditions will be protected.
- If you select **[Unprotect all found]**, the protection of all the filtered images will be canceled.

### ⚠ Caution

- If you format the card (🗑), the protected images will also be erased.

### 📄 Note

- Once an image is protected, it cannot be erased by the camera's erase function. To erase a protected image, you must first cancel the protection.
- If you erase all the images (🗑), only the protected images will remain. This is convenient when you want to erase all unneeded images at once.



## Erasing Images

---

- [Erasing Images Individually](#)
- [Selecting \(\[√\]\) Multiple Images to Erase Together](#)
- [Specifying the Range of Images to Erase](#)
- [Erasing All Images in a Folder or on a Card](#)

You can either select and erase unnecessary images individually or erase them in one batch. Protected images (🔒) will not be erased.





### ⚠ Caution

- **Once an image is erased, it cannot be recovered. Make sure you no longer need the image before erasing it. To prevent important images from being erased accidentally, protect them.**

---

## Erasing Images Individually

---

1. **Select the image to be erased.**
  - Press the <  > button.
  - Use the <  >> <<  > keys for selection.
  
2. **Press the <  > key.**



### 3. Erase the images.

JPEG or RAW images or movies



- Select [Erase].

RAW+JPEG images



- Select an option.

## Selecting ([✓]) Multiple Images to Erase Together

By adding checkmarks to the images to be erased, you can erase all those images at once.

### 1. Select [▶]: Erase images].

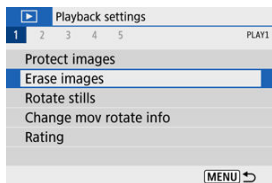

### 2. Select [Select and erase images].

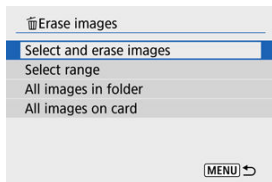

### 3. Select an image.



- Use the <◀>>▶> keys to select an image to erase, then press the <SET> button.
- To select another image to be erased, repeat step 3.
- Press the <MENU> button, then press [OK].

#### 4. Erase the images.

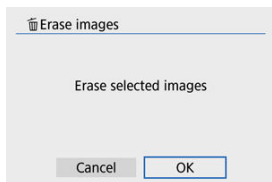

## Specifying the Range of Images to Erase

While looking at the images in the index display, you can specify the first and last images for a range to erase all the specified images at once.

### 1. Select [Select range].

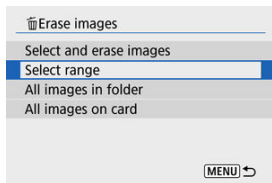

### 2. Specify the range of images.



- Select the first image (start point).
- Next, select the last image (end point).

### 3. Press the <MENU> button.

#### 4. Erase the images.

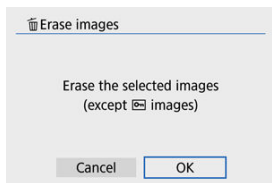

- Select **[OK]**.

## Erasing All Images in a Folder or on a Card

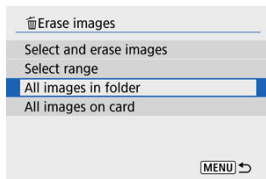

- When you select **[All images in folder]** or **[All images on card]** in **[▶]: Erase images**, all the images in the folder or on the card will be erased.
- If the search conditions are set with **[▶]: Set image search conditions** (🔍), the display will change to **[All found images]**.

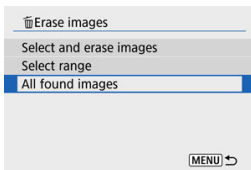

- If you select **[All found images]**, all the images filtered by the search conditions will be erased.

### Note

- To erase all the images including protected images, format the card (🔒).

# Rotating Still Photos

---

You can use this feature to rotate the displayed image to the desired orientation.

---

## 1. Select [ ]: Rotate stills].

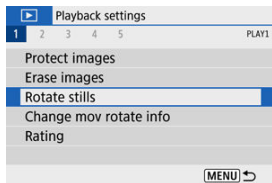

## 2. Select an image.

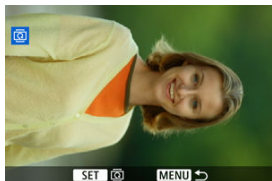

- Use the < ◀ ▶ > keys to select an image to rotate.

## 3. Rotate the image.

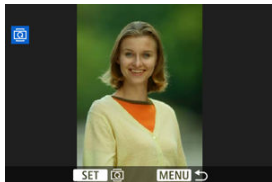

- Each time you press the < (R) > button, the image is rotated clockwise as follows: 90° → 270° → 0°.
- To rotate another image, repeat steps 2 and 3.





## Note

- If you set [**F**: **Auto rotate**] to [On ] () before taking pictures, you need not rotate the image with this function.
- If the rotated image is not displayed rotated during playback, set [**F**: **Auto rotate**] to [On ].

## Changing Movie Orientation Information

---

You can manually change movie orientation information (which determines which side is up).

---

1. Select []: Change mov rotate info].

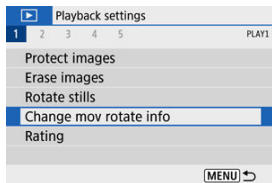

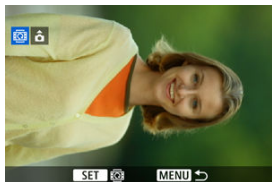

2. Select a movie.



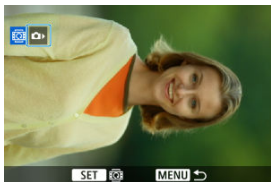

- Use the << >> >> >> keys to select a movie with orientation information to change.

3. Press the <  > button.



- As you watch the camera orientation icon in the upper left, press the <  > button to specify which side is up.

 **Note**

- Movies are played horizontally on the camera, regardless of the [: **Add**  **rotate info**] setting ().

# Rating Images

---

- [Rating a Single Image](#)
- [Rating by Specifying the Range](#)
- [Rating All Images in a Folder or on a Card](#)

You can rate images on a scale of 1–5 ([\*]/[\* \*]/[\* \* \*]/[\* \* \* \*]/[\* \* \* \* \*]). This function is called rating.  
\* Rating images can help you organize them.

---

## Rating a Single Image

---

1. Select [**▶**]: **Rating**.

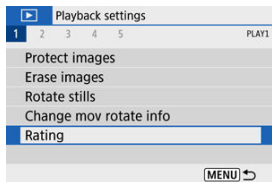

2. Select [**Select images**].

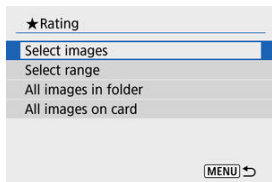

### 3. Select the image to be rated.

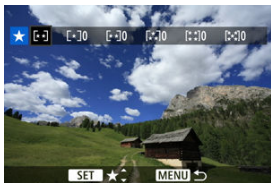

- Use the < ◀ ▶ > keys to select an image to rate.

### 4. Rate the image.

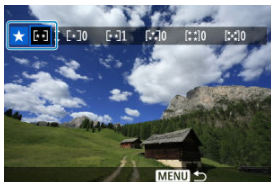

- Press the < (SET) > button so that the current rating is outlined in blue, as shown.
- Use the < ▲ > < ▼ > keys to select a rating mark, then press the < (SET) > button.  
When you append a rating mark to the image, the number beside the set rating will increase by one.
- To rate another image, repeat steps 3 and 4.

## Rating by Specifying the Range

While looking at the images in the index display, you can specify the first and last images for a range to rate all the specified images at once.

### 1. Select [Select range].

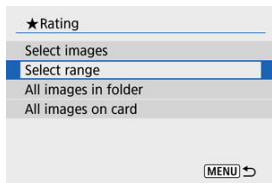

### 2. Specify the range of images.



- Select the first image (start point).
- Next, select the last image (end point).  
A checkmark [✓] will be appended to all the images within the range between first and last images.

### 3. Press the <MENU> button.

## 4. Rate the image.



- Turn the <  > dial to select a rating mark, then select **[OK]**. All the images in the specified range will be rated (same rating) at once.

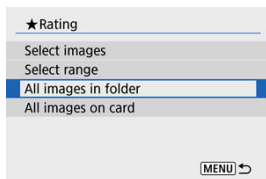

## Rating All Images in a Folder or on a Card

You can rate all the images in a folder or on a card at once.

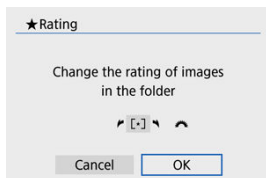

- Under **[▶]: Rating**, when you select **[All images in folder]** or **[All images on card]**, all the images in the folder or on the card will be rated.



- Turn the <  > dial to select a rating mark, then select **[OK]**.
- When you are not rating images or canceling the rating, select **[OFF]**.
- If the search conditions are set with **[▶]: Set image search conditions** , the display will change to **[All found images]**.



- If you select **[All found images]**, all the images filtered by the search conditions will be rated as specified.





#### Note

- Values next to ratings are displayed as [###] if more than 1,000 images have that rating.
- With [▶]: **Set image search conditions**] and [▶]: **Image jump w/🌅**], you can display only the images given a specific rating.

# Print Ordering (DPOF)

---

 [Setting Print Options](#)

 [Selecting Images for Printing](#)

DPOF (Digital Print Order Format) enables you to print images recorded on the card according to your printing instructions such as the image selection, quantity to print, etc. You can print multiple images in one batch or create a print order for a photofinisher.

You can set the print settings such as print type, date imprinting, file number imprinting, etc. The print settings will be applied to all the images specified for printing. (They cannot be set individually for each image.)

---

## Setting Print Options

---

1. Select [: Print order].

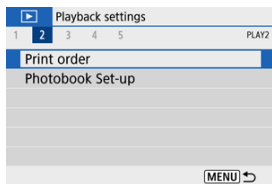

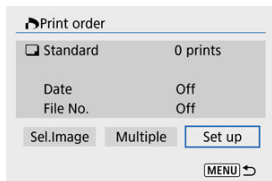

2. Select [Set up].



### 3. Set the options as desired.

- Set **[Print type]**, **[Date]**, and **[File No.]** options.

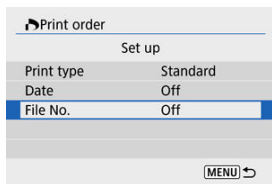

<b>Print type</b>		<b>Standard</b>	Prints one image on one sheet.
		<b>Index</b>	Multiple thumbnail images are printed on one sheet.
		<b>Both</b>	Prints both the standard and index prints.
<b>Date</b>	<b>On</b>	[On] imprints the recorded date of the captured image.	
	<b>Off</b>		
<b>File No.</b>	<b>On</b>	[On] imprints the file number.	
	<b>Off</b>		

### 4. Exit the setting.



- Press the < **MENU** > button.
- Next, select **[Sel.Image]** or **[Multiple]** to specify the images to be printed.

 **Caution**

- If you print an image with a large image size using the **[Index]** or **[Both]** setting () , the index print may not be printed with certain printers. In this case, resize the image () , then print the index print.
- Even if **[Date]** and **[File No.]** are set to **[On]**, the date or file number may not be printed, depending on the print type setting and printer.
- With **[Index]** prints, the **[Date]** and **[File No.]** cannot both be set to **[On]** at the same time.
- When printing with DPOF, use the card for which print order specifications are set. You cannot print in the specified print order if you extract just the images from the card for printing.
- Certain DPOF-compliant printers and photofinishers may not be able to print the images as you specified. When using a printer, refer to the printer's instruction manual. When requesting service from a photofinisher, ask in advance.
- Do not use this camera to configure print settings for images with DPOF settings set up on another camera. All the print orders may be overwritten inadvertently. Also, the print order may not be possible, depending on the image type.

## Selecting Images for Printing

### ● Sel.Image

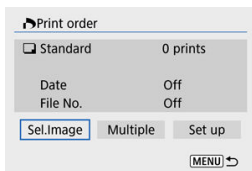

Select and specify the images individually.  
Press the < MENU > button to save the print order to the card.

### • Standard/Both



Press the < 8 > button to set the print quantity for the current image to 1. By pressing the < ▲ > < ▼ > keys, you can set a print quantity of up to 99 copies.

### • Index

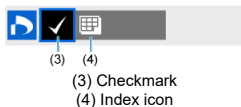

Images that you add a checkmark [✓] to by pressing the < 8 > button are included in index printing.

## ● Multiple

### • Select range

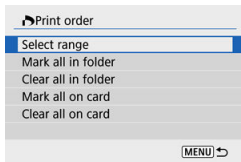

Select [**Select range**] in [**Multiple**]. Selecting the first and last images of the range marks all the images in the range with a checkmark [✓], and one copy of each image will be specified for printing.

### • All images in a folder

Select [**Mark all in folder**] and select the folder. A print order for one copy of all the images in the folder will be specified.

If you select [**Clear all in folder**] and select the folder, the print order for all the images in the folder will be canceled.

### • All images on a card

If you select [**Mark all on card**], one copy of all the images on the card will be specified for printing.

If you select [**Clear all on card**], the print order will be cleared for all the images on the card.

If the search conditions are set with [▶]: **Set image search conditions** (🔍) and you select [**Multiple**], the display will change to [**Mark all found images**] and [**Clear all found images**].

## ● All found images

If you select [**Mark all found images**], one copy of all the images filtered by the search conditions will be specified for printing.

If you select [**Clear all found images**], all the print order of the filtered images will be cleared.

### ⚠ Caution

- RAW images or movies cannot be specified for printing. Note that RAW images or movies will not be specified for printing even if you specify all images with [**Multiple**].

# Photobook Set-up

---

- [Specifying Images Individually](#)
- [Specifying the Image Range for a Photobook](#)
- [Specifying All Images in a Folder or Card](#)

You can specify up to 998 images for printing in a photobook. When you use EOS Utility (EOS software) to import images to a computer, the specified images for a photobook will be copied to a dedicated folder. This function is useful for ordering photobooks online.

---

## Specifying Images Individually

---

1. Select []: Photobook Set-up].

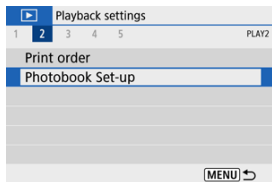

2. Select [Select images].

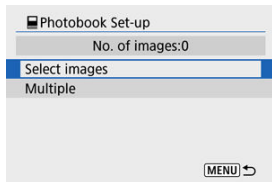

**3. Select the image to be specified.**

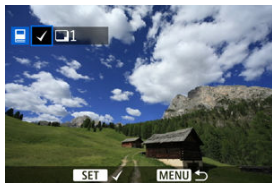

- Use the <◀>>▶> keys to select an image for the photobook, then press the <Ⓜ> button.
- To select other images to be specified for a photobook, repeat step 3.



## Specifying the Image Range for a Photobook

While looking at the images in the index display, you can specify the range (start point to end point) of images to be specified for a photobook at once.

### 1. Select [Multiple].

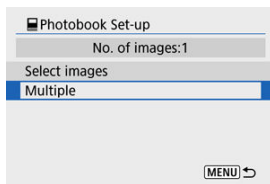

- Select [Multiple] in [▶]: Photobook Set-up.

### 2. Select [Select range].

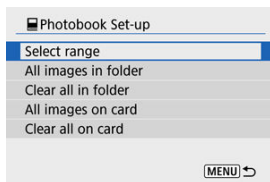

### 3. Specify the range of images.



- Select the first image (start point).
- Next, select the last image (end point). A checkmark [✓] will be appended to all the images within the range between first and last images.

## Specifying All Images in a Folder or Card

You can specify all the images in a folder or on a card at once for a photobook.

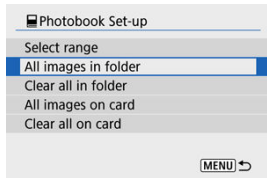

- All images in the folder or on the card are specified for the photobook when you select **[All images in folder]** or **[All images on card]** in the **[Multiple]** option for **[▶]: Photobook Set-up**.
- To cancel the selection, select **[Clear all in folder]** or **[Clear all on card]**.
- If the search conditions are set with **[▶: Set image search conditions] (🔍)** and you select **[Multiple]**, the display will change to **[All found images]** and **[Clear all found images]**.

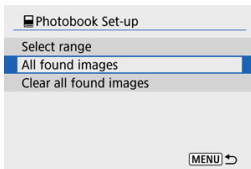

- **[All found images]**: All images filtered by the search conditions are specified for the photobook.
- **[Clear all found images]**: Clears photobook designation of all filtered images.

### ⚠ Caution

- RAW images or movies cannot be specified for the photobook. Note that RAW images or movies will not be specified for the photobook even if you specify all images with **[Multiple]**.
- Do not use this camera to configure photobook settings for images with photobook settings set up on another camera. All the photobook settings may be overwritten inadvertently.

# Creative Assist

---

You can process RAW images by applying your preferred effects and saving as JPEGs.

## 1. Select [MENU]: Creative Assist].

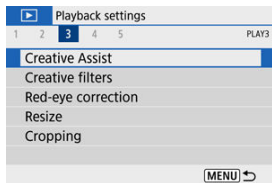

## 2. Select an image.

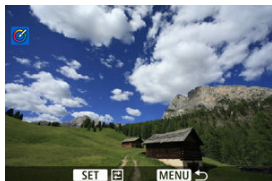

- Use the < ◀ ▶ > keys to select an image to process, then press the < (SET) > button.

### 3. Select an effect.



- Use the <◀▶>> keys to select the effect.



- By selecting **[Preset]** and pressing the <Ⓟ> button, you can choose **[VIVID]**, **[SOFT]**, or other preset effects. **[AUTO1]**, **[AUTO2]**, and **[AUTO3]** are effects recommended by the camera based on image conditions.



- You can select effects such as **[Brightness]** or **[Contrast]** by pressing the <Ⓟ> button and then using the <◀▶>> keys.
- Press the <Ⓟ> button when adjustment is finished.

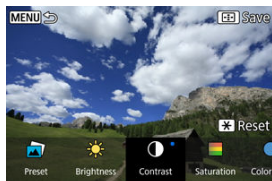

- To reset the effect, press the < ✖ > button.
- To confirm the effect, press the <  > button.

**4. Select [OK] to save the image.**

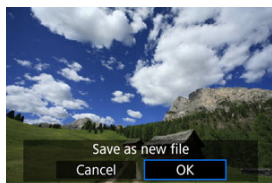

## Creative Filters

---

You can apply the following filter processing to an image and save it as a separate image: Grainy B/W, Soft focus, Fish-eye effect, Art bold effect, Water painting effect, Toy camera effect, and Miniature effect.

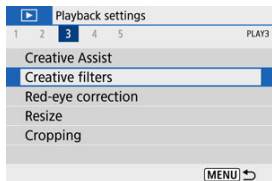

---

### 1. Select [ : Creative filters].

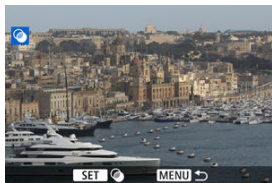

### 2. Select an image.



- Use the << >> >> >> keys to select an image, then press the <  > button.
- To select the image from index display, press the <  > button.

### 3. Select a filter effect (🔍).

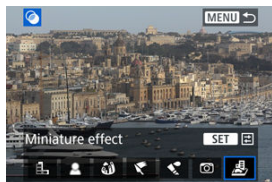

### 4. Adjust the filter effect.

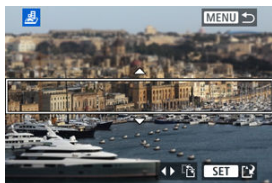

- Adjust the filter effect, then press the <Ⓢ> button.
- For **[Miniature effect]**, turn the <☀> dial or use the <▲><▼> keys to move the white frame enclosing the area to keep in sharper focus, then press the <Ⓢ> button.

### 5. Save.

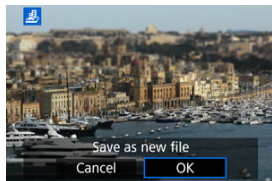

- Select **[OK]**.
- Check the destination folder and image file number, then select **[OK]**.
- To apply filter processing to other images, repeat steps 2–5.





#### Note

- For images captured in RAW+JPEG shooting, filter processing is applied to the RAW image, and the results are saved as a JPEG.
- For RAW images captured at a specific aspect ratio, the resulting image is saved at that aspect ratio after filter processing.
- Images processed using the fish-eye effect filter will not have Dust Delete Data (☑) appended.

## Creative Filter Characteristics

---

-  **Grainy B/W**

Makes the image grainy and black and white. By adjusting the contrast, you can change the black-and-white effect.

-  **Soft focus**

Gives the image a soft look. By adjusting the blur, you can change the degree of softness.

-  **Fish-eye effect**

Gives the effect of a fish-eye lens. The image will have barrel distortion. Depending on the level of this filter effect, the area trimmed along the periphery of the image changes. Also, because this filter effect magnifies the center of the image, the apparent resolution at the center may degrade depending on the number of recorded pixels, so set the filter effect in step 4 while checking the resulting image.

-  **Art bold effect**

Makes the photo look like an oil painting and the subject look more three-dimensional. By adjusting the effect, you can change the contrast and saturation. Note that subjects such as the sky or white walls may not be rendered with a smooth gradation and may look irregular or have significant noise.

-  **Water painting effect**

Makes the photo look like a watercolor painting with soft colors. By adjusting the effect, you can change the color density. Note that night scenes or dark scenes may not be rendered with a smooth gradation and may look irregular or have significant noise.

-  **Toy camera effect**

Shifts colors to those typical of toy cameras and darkens the four corners of the image. Color tone options can be used to change the color cast.

-  **Miniature effect**

Creates a diorama effect. You can change where the image looks sharp. To switch between vertical and horizontal orientation of the sharp area (white frame), press the < ◀ ▶ > keys in step 4.

# Red-Eye Correction

---

Automatically corrects relevant portions of images affected by red-eye. The image can be saved as a separate file.

---

1. Select [: Red-eye correction].

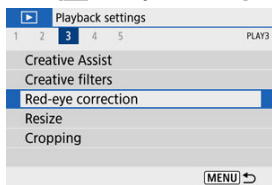

2. Select an image with the < ◀ ▶ > keys.

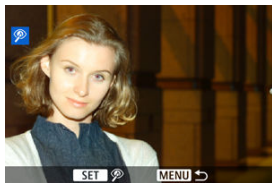

- After image selection, press the <  > button.
- White frames are displayed around corrected image areas.

3. Select [OK].

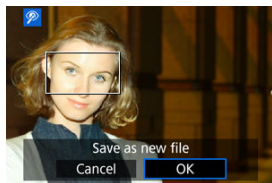

- The image is saved as a separate file.

 Caution

- Some images may not be corrected accurately.

# Resizing

---

You can resize a JPEG image to make the pixel count lower and save it as a new image. Resizing an image is possible only with JPEG **L/M/S1** images. JPEG **S2** and RAW images cannot be resized.

---

## 1. Select [ ]: Resize].

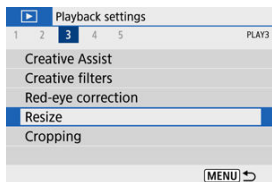

## 2. Select an image.

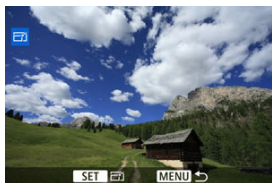

- Use the << >> keys to select an image to resize.

### 3. Select the desired image size.

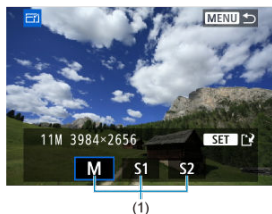

- Press the  $\langle \text{MENU} \rangle$  button to display the image size.
- Select the desired image size (1).

### 4. Save.

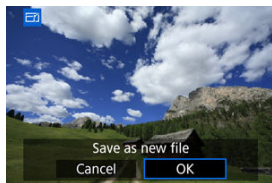

- Select [**OK**] to save the resized image.
- Check the destination folder and image file number, then select [**OK**].
- To resize another image, repeat steps 2 to 4.

# Cropping

---

You can crop a captured JPEG image and save it as another image. Cropping an image is possible only with JPEG images. Images shot in RAW cannot be cropped.

---

## 1. Select [CROPPING].

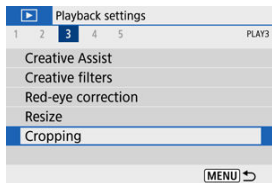

## 2. Select an image.

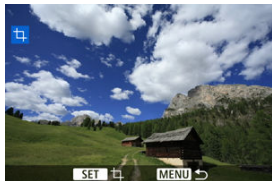

- Use the <<>>> keys to select an image to crop.

### 3. Set the cropping frame.

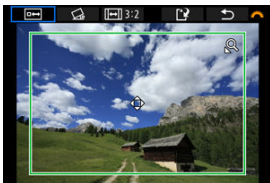

- Press the  $\langle \text{C} \rangle$  button to display the cropping frame.
- The image area within the cropping frame will be cropped.
- **Resizing the cropping frame size**  
Use the  $\langle \text{Q} \rangle$  or  $\langle \text{R} \rangle$  button to resize the cropping frame. The smaller the cropping frame, the more magnified the cropped image will look.
- **Changing the cropping frame aspect ratio and orientation**  
Use the  $\langle \text{S} \rangle$  dial to select  $\langle \text{A} \rangle$ . Press the  $\langle \text{C} \rangle$  button to change the cropping frame aspect ratio.
- **Moving the cropping frame**  
Use the  $\langle \blacktriangle \rangle \langle \blacktriangledown \rangle \langle \blacktriangleleft \rangle \langle \blacktriangleright \rangle$  keys to move the frame vertically or horizontally. Move the cropping frame until it covers the desired image area.
- **Correcting tilt**  
You can correct image tilt by  $\pm 10^\circ$ . Use the  $\langle \text{S} \rangle$  dial to select  $\langle \text{G} \rangle$ , then press the  $\langle \text{C} \rangle$  button. While checking tilt relative to the grid, turn the  $\langle \text{S} \rangle$  dial to straighten the image. After correction is finished, press the  $\langle \text{C} \rangle$  button.



#### 4. Check the image area to be cropped.

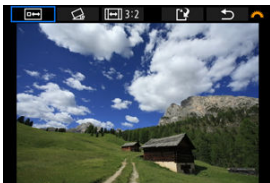

- Use the < sun > dial to select < [crop] >, then press the < [OK] > button. The image area to crop is displayed.

#### 5. Save.

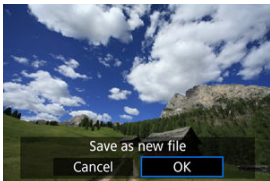

- Use the < sun > dial to select < [save] >, then press the < [OK] > button.
- Select [OK] to save the cropped image.
- Check the destination folder and image file number, then select [OK].
- To crop another image, repeat steps 2 to 5.

#### Caution

- The position and size of the cropping frame may change depending on the angle set for tilt correction.
- Once a cropped image is saved, it cannot be cropped again or resized.
- AF point display information (📍) and Dust Delete Data (📍) will not be appended to the cropped images.

# Slide Show



---

## [Selecting Background Music](#)

You can play back the images on the card as an automatic slideshow.

---

### 1. Specify the images to be played back.

- To play back all the images on the card, go to step 2.
- If you want to specify the images to be played back in the slideshow, filter the images with []: **Set image search conditions** ().

### 2. Select []: Slide show].

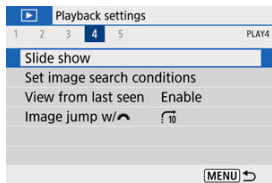

### 3. Set the playback as desired.

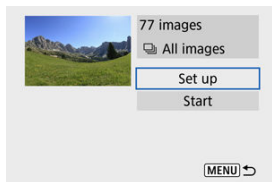

- Select [**Set up**].
- Set the [**Display time**], [**Repeat**] (repeated playback), and [**Transition effect**] (effect when changing images) settings for the still photos.
- To play background music, use [**Background music**] to select the music (🔍).
- After completing the settings, press the <MENU> button.

#### Display time

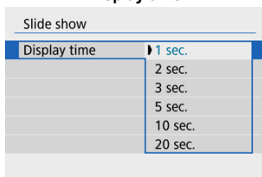

#### Repeat

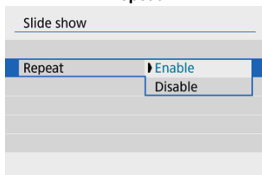

## Transition effect

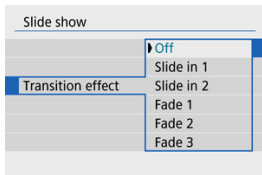

## Background music

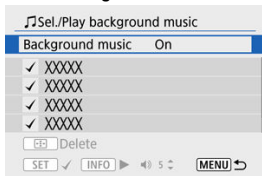

## 4. Start the slideshow.

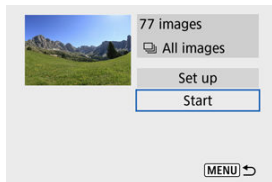





- Select [**Start**].
- After [**Loading image...**] is displayed, the slideshow will start.

## 5. Exit the slideshow.

- To exit the slideshow and return to the setting screen, press the < **MENU** > button.

 **Note**

- To pause the slide show, press the <  > button. During pause,  will be displayed in the upper left of the screen. Press the <  > button again to resume the slide show.
- During the automatic playback of still photos, you can press the < INFO > button to switch the display format ().
- Volume during movie playback can be adjusted with the < ▲ > < ▼ > keys.
- During auto playback or when playback is paused, you can press the < ◀ > ▶ > keys to view other images.
- During auto playback, auto power off will not take effect.
- The display time may differ depending on the image.

## Selecting Background Music

Slideshows can be played with background music once you copy the music to the card, using EOS Utility (EOS software).

### 1. Select [Background music].

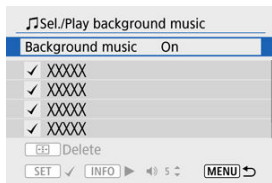

- Set **[Background music]** to **[On]**.

### 2. Select the background music.

- Use the **<▲>** **<▼>** keys to select the music, then press **<Ⓜ>**. For **[Slide show]**, you can select multiple tracks.

### 3. Listen to a sample.

- To listen to a sample, press the **<INFO>** button.
- Use the **<▲>** **<▼>** keys to adjust the volume. Press the **<INFO>** button again to stop playback.
- To delete the music, use the **<▲>** **<▼>** keys to select it, then press the **<Ⓜ>** button.

#### Note

- For instructions on copying background music to cards, refer to the EOS Utility Instruction Manual.

# Setting Image Search Conditions

---

## [Clearing the Search Conditions](#)

You can filter image display according to your search conditions. After setting the image search conditions, you can play back and display only the found images.

You can also protect, rate, play a slideshow, erase, and apply other operations to filtered images.

---

1. Select [: Set image search conditions].

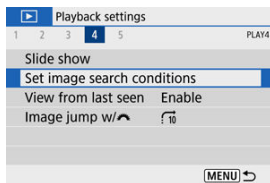

## 2. Set the search conditions.

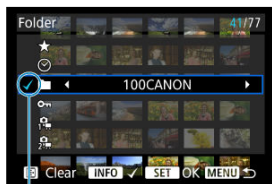

(1)

- Use the <▲><>▼> keys to select an option.
- Use the <◀><>▶> keys to set the option.
- A checkmark [✓] (1) is appended to the left of the option. (Specified as the search condition.)
- If you select the option and press the <INFO> button, the checkmark [✓] will be removed (which cancels the search condition).

Option	Description
★ Rating	Displays images with the selected (rating) condition.
🕒 Date	Displays images taken on the selected shooting date.
📁 Folder	Displays images in the selected folder.
🔒 Protect	Displays images with the selected (protect) condition.
📄 Type of file (1)	Displays images of the selected file type.
📄 Type of file (2)	Displays digest movies.

## 3. Apply the search conditions.

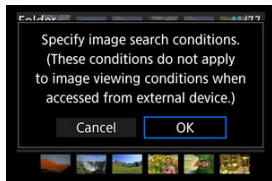

- Press the <ⓘ> button and read the message displayed.
- Select [OK].  
The search condition is applied.



#### 4. Display the found images.



(2)

- Press the < [▶] > button.  
Only the images that match the set conditions (filtered) will be played back.  
When the images are filtered for display, the screen will have an outer yellow frame (2).

## Clearing the Search Conditions

Access the screen in step 2, then press the < [⊞] > button to clear all the search conditions.

### ! Caution

- If no images match the search conditions, pressing the < [⊞] > button in step 3 has no effect.

### 📄 Note

- Search conditions may be cleared if you perform power, card, or image editing operations.
- Auto power off time may be extended while the [▶]: **Set image search conditions** screen is displayed.

## Resuming from Previous Playback

---

1. Select [▶]: View from last seen.

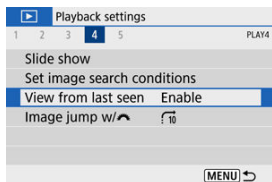

2. Select an option.

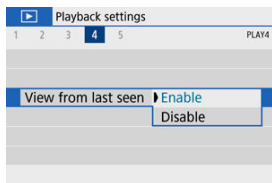

- **[Enable]**: Playback resumes from the last image displayed (unless you have just finished shooting).
- **[Disable]**: Playback resumes from your most recent shot whenever the camera is restarted.

# Browsing Images with the Dial

In single-image display, you can turn the <  > dial to jump through the images forward or backward according to the jump method set.



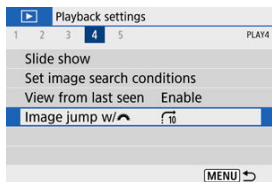

## 1. Select []: Image jump w/].



## 2. Select the jump method.



### Note

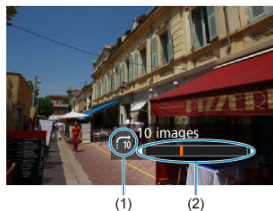

- With [**Jump images by the specified number**], you can turn the <  > dial to select the number of images to jump by.
- With [**Display by image rating**], turn the <  > dial to select the rating (). Selecting  will show all rated images as you browse.

### 3. Browse by jumping.



(1) Jump method

(2) Playback position

- Press the <  > button.
- In single-image display, turn the <  > dial.  
You can browse by the jump method set.



The brightness histogram shows the exposure level distribution and overall brightness. The RGB histogram is for checking the color saturation and gradation.

### ● [Brightness] display

This histogram is a graph showing the distribution of the image's brightness level, with the horizontal axis indicating the brightness level (darker on the left and brighter on the right) and the vertical axis indicating the pixel count at each brightness level. The more pixels there are toward the left, the darker the image, and the more pixels there are toward the right, the brighter the image. If there are too many pixels on the left, detail in shadows will be lost, and if there are too many pixels on the right, detail in highlights will be lost. The gradation in-between will be reproduced. By checking the image and its brightness histogram, you can see the exposure level inclination and the overall gradation.

#### Sample histograms



Dark image



Normal brightness



Bright image

- **[RGB] display**

This histogram is a graph showing the distribution of each primary color's brightness level in the image (RGB or red, green, and blue), with the horizontal axis indicating the color's brightness level (darker on the left and brighter on the right) and the vertical axis indicating the pixel count at each color brightness level. The more pixels there are toward the left, the darker and less prominent the color, and the more pixels there are toward the right, the brighter and denser the color. If there are too many pixels on the left, the corresponding color information will be lacking, and if there are too many pixels on the right, the color will be too saturated, without gradation. By checking the image's RGB histogram, you can see the color's saturation and gradation conditions, as well as the white balance bias.

# AF Point Display

---

You can display the AF points that were used to focus, which will be outlined in red on the playback screen. If automatic AF point selection is set, multiple AF points may be displayed.

1. Select []: AF point disp.].

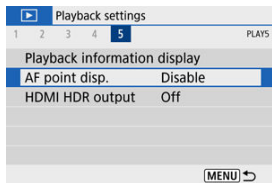

2. Select [Enable].

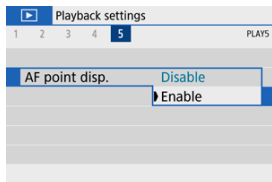



# HDMI HDR Output

You can view RAW images in HDR by connecting the camera to an HDR TV.

## 1. Select [▶]: HDMI HDR output].

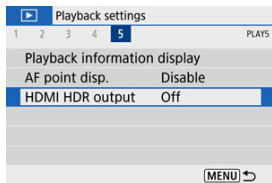

## 2. Select [On].

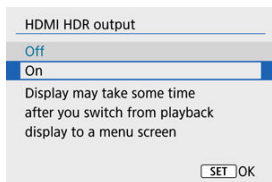

### Note

- Make sure the HDR TV is set up for HDR input. For details on how to switch inputs on the TV, refer to the TV manual.
- Depending on the TV used, images may not look as expected.
- Some image effects and information may not be displayed on an HDR TV.

## Wireless Features

---

This chapter describes how to connect the camera to a smartphone wirelessly via Bluetooth® or Wi-Fi® and send images to devices or Web services, how to control the camera from a computer or wireless remote control, and other operations.

### Caution

#### Important

- Note that Canon cannot be held liable for any loss or damage caused by erroneous wireless communication settings when using the camera. In addition, Canon cannot be held liable for any other loss or damage caused by use of the camera. When using wireless communication functions, establish appropriate security at your own risk and discretion. Canon cannot be held liable for any loss or damage caused by unauthorized access or other security breaches.

- [Tab Menus: Wireless Settings](#)
- [Wi-Fi/Bluetooth Connection](#)
- [Connecting to a Smartphone](#)
- [Connecting to a Computer via Wi-Fi](#)
- [Connecting to a Printer via Wi-Fi](#)
- [Sending Images to a Web Service](#)
- [Wi-Fi Connection via Access Points](#)
- [Connecting to a Wireless Remote Control](#)
- [Reconnecting via Wi-Fi](#)
- [Registering Multiple Connection Settings](#)
- [Airplane Mode](#)
- [Wi-Fi Settings](#)
- [Bluetooth Settings](#)
- [Nickname](#)
- [GPS Settings](#)
- [Changing or Deleting Connection Settings](#)
- [Resetting Communication Settings](#)
- [View Info Screen](#)
- [Virtual Keyboard Operations](#)
- [Responding to Error Messages](#)
- [Wireless Communication Function Precautions](#)
- [Security](#)
- [Checking Network Settings](#)
- [Wireless Communication Status](#)

## Tab Menus: Wireless Settings

### ● Wireless Settings 1

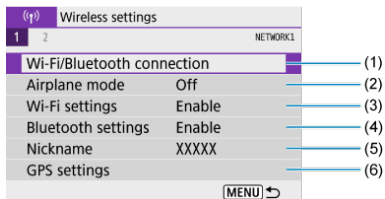

- (1) [Wi-Fi/Bluetooth connection](#)
- (2) [Airplane mode](#)
- (3) [Wi-Fi settings](#)
- (4) [Bluetooth settings](#)
- (5) [Nickname](#)
- (6) [GPS settings](#)

### ● Wireless Settings 2

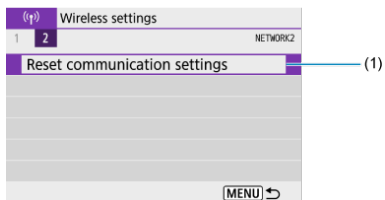

- (1) [Reset communication settings](#)

#### ⚠ Caution

- Wireless communication is not available while the camera is connected via an interface cable to a computer or other device.
- Other devices, such as computers, cannot be used with the camera by connecting them with an interface cable while the camera is connected to devices via Wi-Fi.
- The Wi-Fi connection will be terminated if you set the camera power to < OFF > or open the card/battery compartment cover.
- With a Wi-Fi connection established, the camera's auto power off does not function.

# Wi-Fi/Bluetooth Connection

## 1. Select [(P): Wi-Fi/Bluetooth connection].

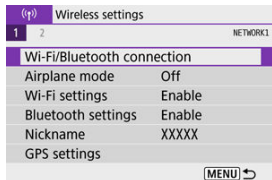

## 2. Select an option for the camera to connect to.



### **Connect to smartphone**

Control the camera remotely and browse images on the camera over a Wi-Fi connection by using the dedicated Camera Connect app on smartphones or tablets (collectively referred to as “smartphones” in this manual).

After pairing the camera with a smartphone supporting Bluetooth low energy technology (hereafter, “Bluetooth”), you only need to use the smartphone to connect via Wi-Fi.

### **Remote control (EOS Utility)**

Connect the camera to a computer via Wi-Fi and operate the camera remotely using EOS Utility (EOS software). Images on the camera can also be sent to the computer automatically.

### **Print from Wi-Fi printer**

Connect the camera to a printer via Wi-Fi to print images.

## **Upload to Web service**

Images can be sent directly from the camera to the image.canon cloud service for Canon customers after you complete member registration (free of charge). Original files of images sent to image.canon are retained for 30 days, without storage limitations, and can be downloaded to computers or transferred to other Web services.

## **Connect to Wireless Remote**

This camera can also be connected to Wireless Remote Control BR-E1 (sold separately) via Bluetooth for remote control shooting.

## Connecting to a Smartphone

---

- [☑ Turning on Bluetooth and Wi-Fi on a Smartphone](#)
- [☑ Installing Camera Connect on a Smartphone](#)
- [☑ Connecting to a Bluetooth-Compatible Smartphone via Wi-Fi](#)
- [☑ Main Functions of Camera Connect](#)
- [☑ Maintaining a Wi-Fi Connection When the Camera Is Off](#)
- [☑ Canceling the Pairing](#)
- [☑ Wi-Fi Connection without Using Bluetooth](#)
- [☑ Automatic Image Transfer as You Shoot](#)
- [☑ Sending Images to a Smartphone from the Camera](#)
- [☑ Terminating Wi-Fi Connections](#)
- [☑ Settings to Make Images Viewable from Smartphones](#)

You can do the following after pairing the camera with a Bluetooth-compatible smartphone.

- Establish a Wi-Fi connection using only the smartphone (☑).
- Establish a Wi-Fi connection with the camera even when it is off (☑).
- Geotag images with GPS information acquired by the smartphone (☑).
- Control the camera remotely from a smartphone (☑).

You can also do the following after connecting the camera to a smartphone via Wi-Fi.

- Browse and save images on the camera from a smartphone (☑).
  - Control the camera remotely from a smartphone (☑).
  - Send images to a smartphone from the camera (☑).
-

## Turning on Bluetooth and Wi-Fi on a Smartphone

---

Turn on Bluetooth and Wi-Fi from the smartphone settings screen. Note that pairing with the camera is not possible from the smartphone's Bluetooth settings screen.



### Note

- To establish a Wi-Fi connection via an access point, see [Wi-Fi Connection via Access Points](#).

## Installing Camera Connect on a Smartphone

---

The dedicated app Camera Connect (free of charge) must be installed on the smartphone on which Android or iOS is installed.

- Use the latest version of the smartphone OS.
- Camera Connect can be installed from Google Play or App Store. Google Play or App Store can also be accessed using the QR codes that appear when the camera is paired or connected via Wi-Fi to a smartphone.



### Note

- For the operating system versions supported by Camera Connect, refer to the download site of Camera Connect.
- Sample screens and other details in this guide may not match the actual user interface elements after camera firmware updates or updates to Camera Connect, Android, or iOS.



## Connecting to a Bluetooth-Compatible Smartphone via Wi-Fi

### Steps on the camera (1)

1. Select [(Ⓜ)]: Wi-Fi/Bluetooth connection].

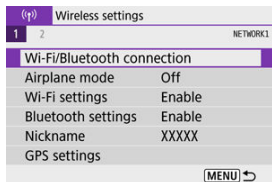

2. Select [☑️Connect to smartphone].



3. Select [Add a device to connect to].

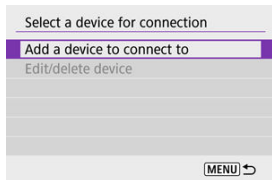

#### 4. Select an option.

Install Camera Connect on the smartphone. Display QR code for download site?

Do not display

Android

iOS

- If Camera Connect is already installed, select [**Do not display**].
- If Camera Connect is not installed, select [**Android**] or [**iOS**], scan the displayed QR code with the smartphone to access Google Play or App Store and install Camera Connect.

## 5. Select [Pair via Bluetooth].

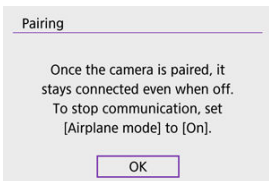

- Press the <  > button to start pairing.

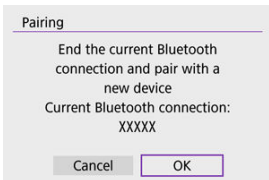
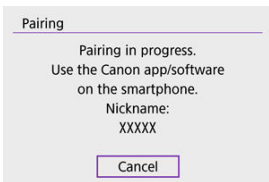

- To pair with a different smartphone after pairing with one initially, select [OK] on the screen shown above.

## Steps on the smartphone (1)

### 6. Start Camera Connect.

- Following the instructions in the app, select the camera for pairing.

## Steps on the camera (2)

### 7. Select [OK].

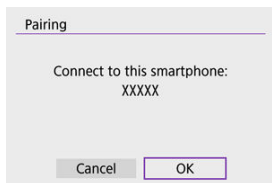

### 8. Press the < > button.

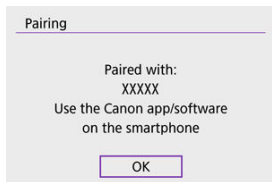

- Pairing is now complete, and the camera is connected to the smartphone via Bluetooth.
- When a message appears on the smartphone, use the smartphone as indicated.

#### Caution

- The camera cannot be connected to two or more devices at the same time via Bluetooth. To switch to a different smartphone for the Bluetooth connection, see [Changing or Deleting Connection Settings](#).
- Bluetooth connection consumes battery power even after the camera's auto power off is activated. Therefore, the battery level may be low when you use the camera.

#### Troubleshooting pairing

- Keeping pairing records for previously paired cameras on your smartphone will prevent it from pairing with this camera. Before you try pairing again, remove pairing records for previously paired cameras from your smartphone's Bluetooth settings screen.



#### Note

- With a Bluetooth connection established, you can operate the camera to send images to the smartphone (📱).

## Steps on the smartphone (2)

### 9. Tap a Camera Connect function.

- For details on Camera Connect functions, see [Main Functions of Camera Connect](#).
- Tap a Camera Connect function to initiate a Wi-Fi connection.
- When a Wi-Fi connection is established, the screen for the selected function will appear.

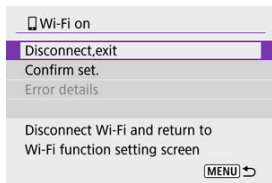

- [Wi-Fi on] is displayed on the camera screen.

### The Wi-Fi connection to a Bluetooth-compatible smartphone is now complete.

- For how to terminate the Wi-Fi connection, see [Terminating Wi-Fi Connections](#).
- Terminating the Wi-Fi connection will switch the camera to the Bluetooth connection.
- To reconnect via Wi-Fi, start Camera Connect and tap the function you will use.

## Wi-Fi on] screen

### **Disconnect,exit**

- Terminates the Wi-Fi connection.

### **Confirm set.**

- You can check the settings.

### **Error details**

- When a Wi-Fi connection error occurs, you can check the details of the error.



## Main Functions of Camera Connect

---

### Images on camera

- Images can be browsed, deleted, or rated.
- Images can be saved on a smartphone.
- Effects can be applied to RAW images from a smartphone ([Creative Assist](#)).

### Remote live view shooting

- Enables remote shooting as you view a live image on the smartphone.

### Auto transfer

- Enables camera and app setting adjustment for automatic transfer of your shots ()

### Bluetooth remote controller

- Enables remote control of the camera from a smartphone paired via Bluetooth. (Not available when connected via Wi-Fi.)
- Auto power off is disabled while you are using the Bluetooth remote controller feature.

### Camera settings

- Camera settings can be changed.

You can check other functions from the main Camera Connect screen.

## Maintaining a Wi-Fi Connection When the Camera Is Off

Even when the camera power switch is set to <OFF>, as long as it is paired to a smartphone via Bluetooth, you can use the smartphone to connect via Wi-Fi and browse images on the camera or perform other operations.

If you prefer not to connect via Wi-Fi to the camera when it is off, either set [Airplane mode] to [On] or set [Bluetooth settings] to [Disable].

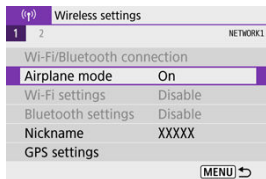

### Caution

- This function can no longer be used if the wireless settings are reset or the smartphone connection information is erased.

## Canceling the Pairing

Cancel pairing with a smartphone as follows.

### 1. Select [(P): Wi-Fi/Bluetooth connection].

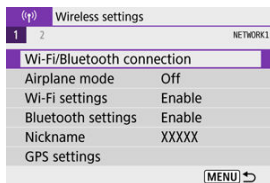

### 2. Select [☑ Connect to smartphone].



- If the history (☑) is displayed, press the < ◀ ▶ > keys to switch the screen.

### 3. Select [Edit/delete device].

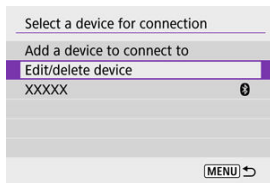

**4. Select the smartphone to cancel pairing with.**

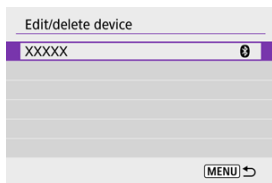

- Smartphones currently paired with the camera are labeled **[📱]**.

**5. Select [Delete connection information].**

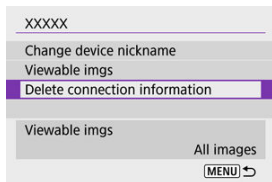

**6. Select [OK].**

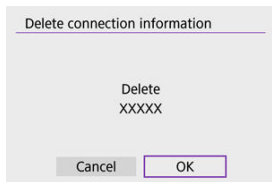

**7. Clear the camera information on the smartphone.**

- In the smartphone's Bluetooth setting menu, clear the camera information registered on the smartphone.

## Wi-Fi Connection without Using Bluetooth

### Steps on the camera (1)

1. Select [(q): Wi-Fi/Bluetooth connection].

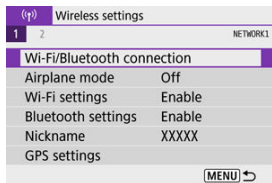

2. Select [☐Connect to smartphone].

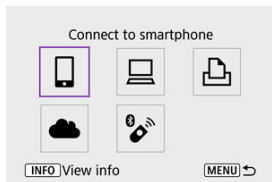

- If the history (q) is displayed, press the < ◀ ▶ > keys to switch the screen.

3. Select [Add a device to connect to].

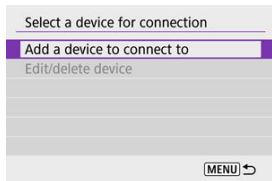

#### 4. Select an option.

Install Camera Connect on the smartphone. Display QR code for download site?

Do not display

Android

iOS

- If Camera Connect is already installed, select [**Do not display**].

#### 5. Select [**Connect via Wi-Fi**].

Connect to smartphone

Pair via Bluetooth

**Connect via Wi-Fi**

Establish a Wi-Fi connection, using the camera and smartphone

MENU ↶

#### 6. Check the SSID (network name) and password.

Waiting to connect

Connect device to camera using network settings below and then start Canon app/software

SSID

XXXXX-XXX\_CanonXX

Password

XXXXXXXXXX

Cancel

Switch network

(2)

(1)

- Check the SSID (1) and Password (2) displayed on the camera screen.
- No password is displayed or required if you set [**Password**] to [**None**] in [**Wi-Fi settings**] (🔗).



#### Note

- By selecting **[Switch network]** in step 6, you can establish a Wi-Fi connection via an access point (📶).

## Steps on the smartphone

### 7. Operate the smartphone to establish a Wi-Fi connection.

Smartphone's screen (sample)

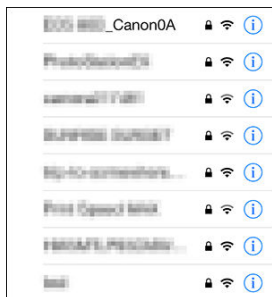

- Activate the smartphone's Wi-Fi function, then tap the SSID (network name) checked in step 6 in [Steps on the camera \(1\)](#).
- For the password, enter the password checked in step 6 in [Steps on the camera \(1\)](#).

### 8. Start Camera Connect and pair with the camera.



## Steps on the camera (2)

### 9. Select [OK].

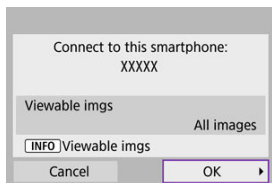

- To specify viewable images, press the <INFO> button. Configure as described in [Settings to Make Images Viewable from Smartphones](#), starting in step 5.

### The Wi-Fi connection to a smartphone is now complete.

- Operate the camera using Camera Connect ()
- For how to terminate the Wi-Fi connection, see [Terminating Wi-Fi Connections](#).
- To reconnect via Wi-Fi, see [Reconnecting via Wi-Fi](#).

#### Note

- When connected via Wi-Fi, you can send images to a smartphone from the Quick Control screen during playback ()

## Automatic Image Transfer as You Shoot

Your shots can be automatically sent to a smartphone. Before following these steps, make sure the camera and smartphone are connected via Wi-Fi.

### 1. Select [(Wi-Fi icon): Wi-Fi settings].

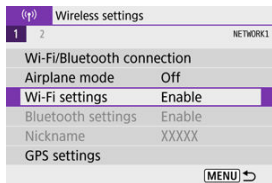

### 2. Select [Send to smartphone after shot].

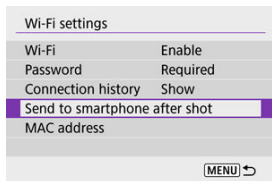

### 3. Set [Auto send] to [Enable].

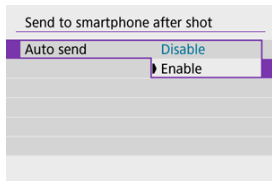

**4. Set [Size to send].**

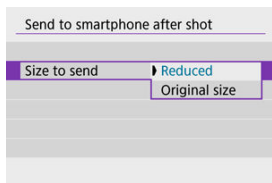

**5. Take the picture.**

## Sending Images to a Smartphone from the Camera

You can use the camera to send images to a smartphone paired via Bluetooth (Android devices only) or connected via Wi-Fi.

1. Switch to playback.



2. Press the  button.

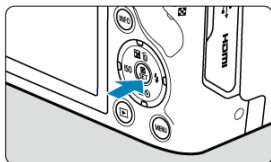

3. Select  Send images to smartphone].

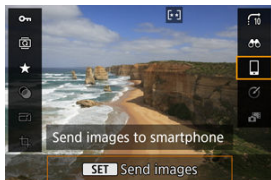





- If you perform this step while connected via Bluetooth, a message is displayed, and the connection switches to a Wi-Fi connection.

4. Select sending options and send the images.

## (1) Sending images individually

### 1. Select an image to send.



- Use the <  > dial or <  ><  > keys to select an image to send, then press the <  > button.
- To select the image from index display, press the <  > button.

### 2. Select [Send img shown].

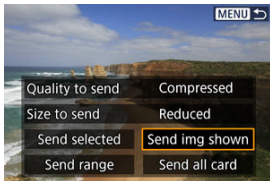

- In [**Size to send**], you can select the image sending size.
- When sending movies, you can select the image quality of movies to send in [**Quality to send**].

## (2) Sending multiple selected images

1. Press the <  > button.





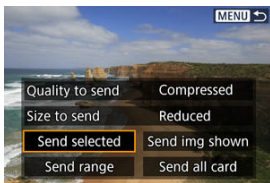

2. Select [Send selected].





### 3. Select images to send.



- Use the <  > dial or <  ><  > keys to select an image to send, then press the <  > button.



- You can press the <  > button to select the images from 3-image display. To return to the single-image display, press the <  > button.
- After selecting the images to send, press the < **MENU** > button. Select [**OK**] when a message is displayed.

#### 4. Select [Size to send].

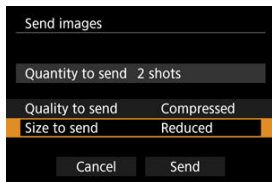

- On the displayed screen, select an image size.

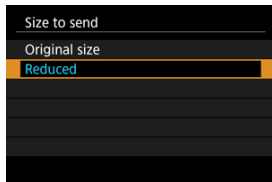

- When sending movies, select the image quality in [Quality to send].

#### 5. Select [Send].

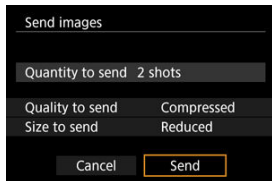



### (3) Sending a specified range of images

1. Press the  button.



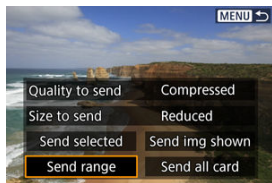

2. Select [Send range].

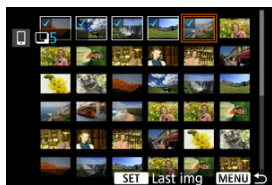

3. Specify the range of images.



- Select the first image (start point).
- Next, select the last image (end point). A checkmark [✓] will be appended to all the images within the range between first and last images.
- To cancel the selection, repeat this step.
- To change the number of images shown in index display, press the  or  button.

#### 4. Confirm the range.

- Press the < MENU > button.  
Select [OK] when a message is displayed.

#### 5. Select [Size to send].

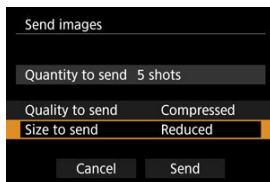

- On the displayed screen, select an image size.

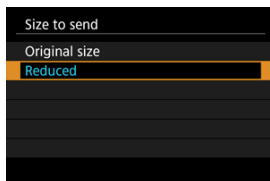

- When sending movies, select the image quality in [Quality to send].

#### 6. Select [Send].

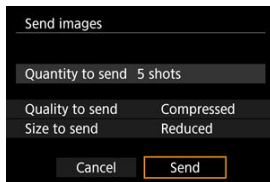

#### (4) Sending all images on the card

1. Press the <  > button.



2. Select [Send all card].

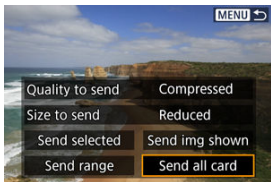

### 3. Select [Size to send].

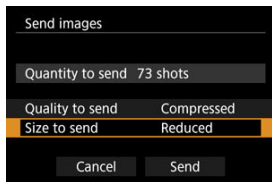

- On the displayed screen, select an image size.

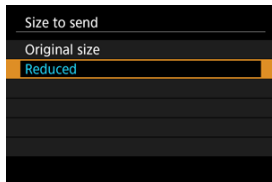

- When sending movies, select the image quality in [Quality to send].

### 4. Select [Send].

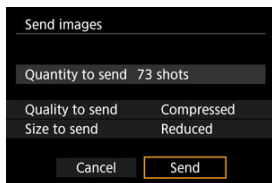

## (5) Sending images that match the search conditions

Send all the images that match the search conditions set in [Set image search conditions] at once. For details on [Set image search conditions], see [Setting Image Search Conditions](#).

1. Press the <  > button.



2. Select [Send all found].



### 3. Select [Size to send].

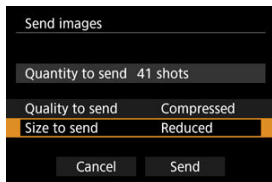

- On the displayed screen, select an image size.

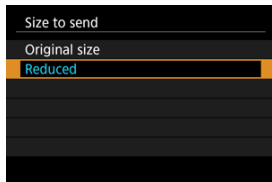

- When sending movies, select the image quality in [Quality to send].

### 4. Select [Send].

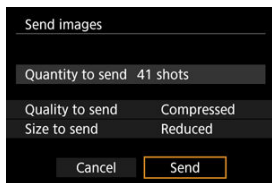

## Ending image transfer

- Press the <MENU> button on the image transfer screen.
- To terminate the Wi-Fi connection, see [Terminating Wi-Fi Connections](#).

### Caution

- During the image transfer operation, a picture cannot be taken even if the camera's shutter button is pressed.

### Note

- You can cancel the image transfer by selecting [**Cancel**] during the transfer.
- You can select up to 999 files at a time.
- With a Wi-Fi connection established, disabling the smartphone's power saving function is recommended.
- Selecting the reduced size for still photos applies to all still photos sent at that time. Note that **S2** size still photos are not reduced.
- Selecting compression for movies applies to all movies sent at that time.
- When you use a battery to power the camera, make sure it is fully charged.

## Terminating Wi-Fi Connections

---

On the [Wi-Fi on] screen, select [Disconnect,exit].

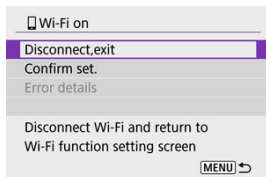

- If the [Wi-Fi on] screen is not displayed, select [(⌘): Wi-Fi/Bluetooth connection].
- Select [Disconnect,exit], then select [OK] on the confirmation screen.



## Settings to Make Images Viewable from Smartphones

Images can be specified after the Wi-Fi connection is terminated.

### 1. Select [(i)]: Wi-Fi/Bluetooth connection].

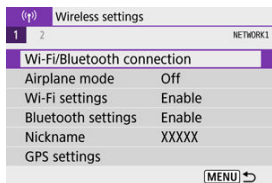

### 2. Select [☑Connect to smartphone].

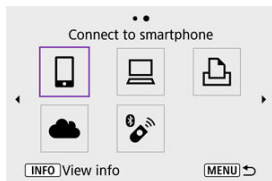

- If the history (i) is displayed, press the < ◀ ▶ > keys to switch the screen.

### 3. Select [Edit/delete device].

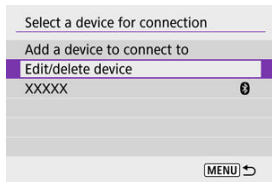

#### 4. Select a smartphone.

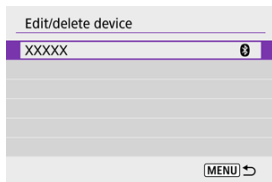

- Select the name of the smartphone on which you want to make the images viewable.

#### 5. Select [Viewable imgs].

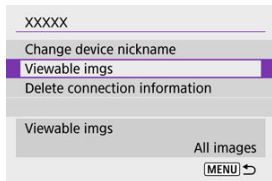

## 6. Select an option.

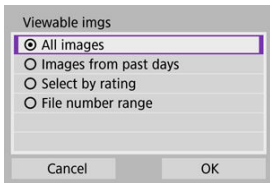

- Select **[OK]** to access the setting screen.

### **[All images]**

- All images stored on the card become viewable.

### **[Images from past days]**

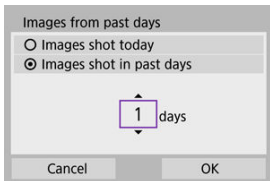

- Specify viewable images on the shooting-date basis. Images shot up to nine days ago can be specified.
- When **[Images shot in past days]** is selected, images shot up to the specified number of days before the current date become viewable. Press the < ▲ > < ▼ > keys to specify the number of days, then press the < (M) > button to confirm the selection.
- Once you select **[OK]**, the viewable images are set.

### **! Caution**

- If **[Viewable imgs]** is set to any setting other than **[All images]**, remote shooting is not possible.

### [Select by rating]



★Select by rating	
★All	25
[★]	5
[★]	0
[★]	12
[★]	8
[★]	0
OFF	18

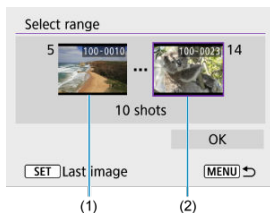

- Specify viewable images depending on whether a rating is appended (or not appended) or by the type of rating.
- Once you select the type of rating, the viewable images are set.

### [File number range] (Select range)



- Select the first and last images from images arranged by the file number to specify the viewable images.
  1. Press the  button to display the image selection screen. To select images, use the  dial or <◀>>▶> keys. To select the image from index display, press the <📍> button.
  2. Select an image as the starting point (1).
  3. Press the <▶> key and select an image as the ending point (2).
  4. Select [OK].

 **Caution**

- If the Wi-Fi connection is terminated while recording a movie with remote shooting, the following will occur.
  - Any movie recording in progress in movie recording mode will continue.
  - Any movie recording in progress in still photo shooting mode will end.
- With a Wi-Fi connection to a smartphone established, certain functions are unavailable.
- In remote shooting, the AF speed may become slower.
- Depending on the communication status, image display or shutter release timing may be delayed.
- When saving images to a smartphone, you cannot take a picture even if you press the camera's shutter button. Also, the camera screen may turn off.

 **Note**

- With a Wi-Fi connection established, disabling the smartphone's power saving function is recommended.

# Connecting to a Computer via Wi-Fi

## [Operating the Camera Using EOS Utility](#)

This section describes how to connect the camera to a computer via Wi-Fi and perform camera operations using EOS software or other dedicated software. Install the latest version of software on the computer before setting up a Wi-Fi connection.

For computer operating instructions, refer to the computer user manual.

## Operating the Camera Using EOS Utility

Using EOS Utility (EOS software), you can import images from the camera, control the camera, and perform other operations.

### Steps on the camera (1)

#### 1. Select []: Wi-Fi/Bluetooth connection].

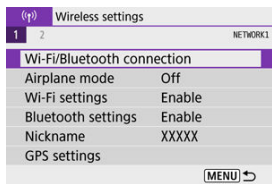

#### 2. Select [] Remote control (EOS Utility)].

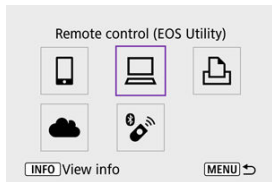

- If the history () is displayed, press the < ◀▶ > keys to switch screens.

### 3. Select [Add a device to connect to].

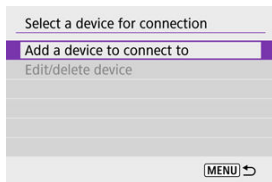

### 4. Check the SSID (network name) and password.

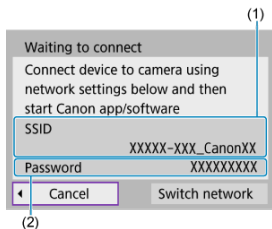

- Check the SSID (1) and Password (2) displayed on the camera screen.
- No password is displayed or required if you set [Password] to [None] in [Wi-Fi settings]. For details, see [Wi-Fi Settings](#).

## Steps on the computer (1)

### 5. Select the SSID, then enter the password.

Computer's screen (sample)

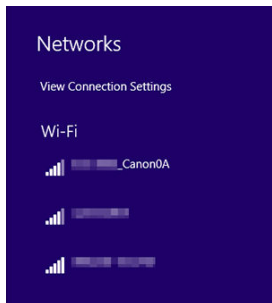

- On the computer's network setting screen, select the SSID checked in step 4 in [Steps on the camera \(1\)](#).
- For the password, enter the password checked in step 4 in [Steps on the camera \(1\)](#).



## Steps on the camera (2)

### 6. Select [OK].

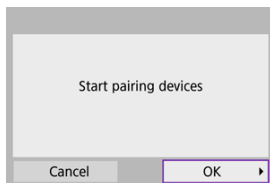

- The following message is displayed. "\*\*\*\*\*" represents the last six digits of the MAC address of the camera to be connected.

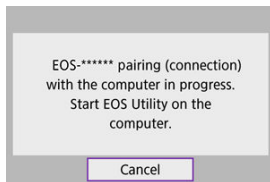

## Steps on the computer (2)

7. Start EOS Utility.

8. In EOS Utility, click [Pairing over Wi-Fi/LAN].

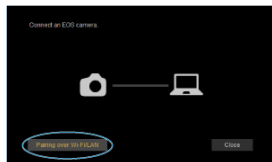

- If a firewall-related message is displayed, select [Yes].

9. Click [Connect].

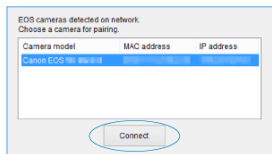

- Select the camera to connect to, then click [Connect].

## Steps on the camera (3)

### 10. Establish a Wi-Fi connection.

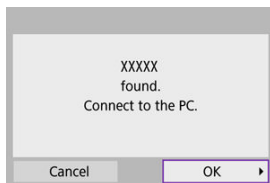

- Select **[OK]**.

## [Wi-Fi on] screen

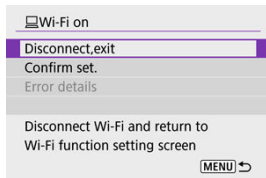

### Disconnect,exit

- Terminates the Wi-Fi connection.

### Confirm set.

- You can check the settings.

### Error details

- When a Wi-Fi connection error occurs, you can check the details of the error.

### The Wi-Fi connection to a computer is now complete.

- Operate the camera using EOS Utility on the computer.
- To reconnect via Wi-Fi, see [Reconnecting via Wi-Fi](#).

### Caution

- If the Wi-Fi connection is terminated while recording a movie with remote shooting, the following will occur.
  - Any movie recording in progress in movie recording mode will continue.
  - Any movie recording in progress in still photo shooting mode will end.
- You cannot use the camera to shoot in still photo shooting mode when it is set to movie recording mode in EOS Utility.
- With a Wi-Fi connection to EOS Utility established, certain functions are unavailable.
- In remote shooting, the AF speed may become slower.
- Depending on the communication status, image display or shutter release timing may be delayed.
- In Remote Live View shooting, the rate of image transmission is slower compared to a connection via an interface cable. Therefore, moving subjects cannot be displayed smoothly.

# Connecting to a Printer via Wi-Fi

---

 [Image Printing](#)

 [Print Settings](#)

This section describes how to print images by directly connecting the camera to a printer via Wi-Fi. For printer operating instructions, refer to the printer user manual.

---

## 1. Select []: Wi-Fi/Bluetooth connection].

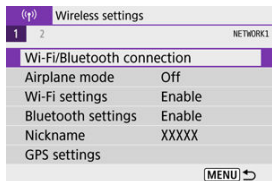

## 2. Select [] Print from Wi-Fi printer].

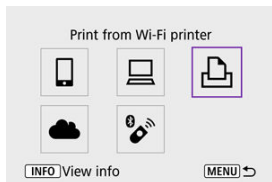

- If the history () is displayed, press the < ◀ ▶ > keys to switch screens.

### 3. Select [Add a device to connect to].

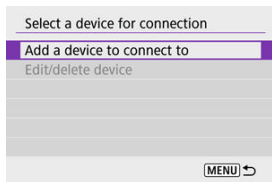

### 4. Check the SSID (network name) and password.

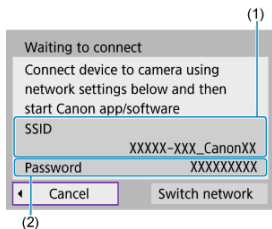

- Check the SSID (1) and Password (2) displayed on the camera screen.
- No password is displayed or required if you set **[Password]** to **[None]** in **[Wi-Fi settings]** (🔒).

### 5. Set up the printer.

- In the Wi-Fi settings menu of the printer to be used, select the SSID you have checked.
- For the password, enter the password checked in step 4.

## 6. Select the printer.

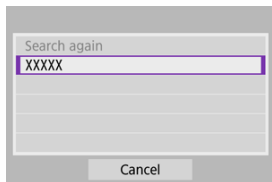

- In the list of detected printers, select the printer to connect to via Wi-Fi.
- If your preferred printer is not listed, selecting [**Search again**] may enable the camera to find and display it.







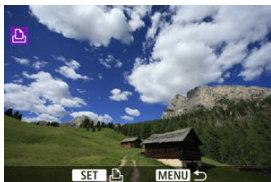

### Note

- To establish a Wi-Fi connection via an access point, see [Wi-Fi Connection via Access Points](#).

### Printing images individually

#### 1. Select the image to be printed.



- Use the <  > dial or <  ><  > keys to select an image to print, then press the <  > button.
- To select the image from index display, press the <  > button.

#### 2. Select [Print image].





### 3. Print the image.

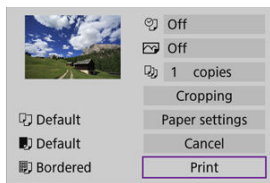

- For the print setting procedures, see [Print Settings](#).
- Select [**P**rint], then [**O**K] to start printing.

## Printing according to specified image options

1. Press the  button.

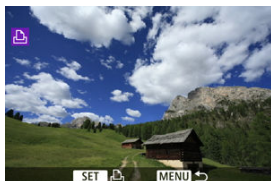

2. Select [Print order].



3. Set the printing options.

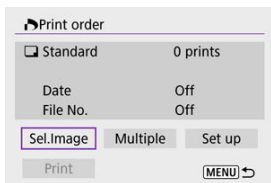

- For the print setting procedures, see [Print Ordering \(DPOF\)](#).
- If the print order is complete before establishing a Wi-Fi connection, go to step 4.

#### 4. Select [Print].

- [Print] can be selected only when an image is selected and the printer is ready to print.

#### 5. Configure [Paper settings] (🔗).

#### 6. Print the image.

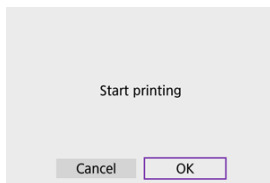

- When [OK] is selected, printing starts.

#### ⚠ Caution

- Shooting is not possible while connected to a printer via Wi-Fi.
- Movies cannot be printed.
- Before printing, be sure to set the paper size.
- File number printing may not be supported by certain printers.
- Dates may be printed on the border by certain printers when [Bordered] is set.
- Depending on the printer, the date may appear faint if it is printed on a bright background or on the border.
- RAW images cannot be printed by selecting [Print order]. Print by selecting [Print image].

 **Note**

- When you use a battery to power the camera, make sure it is fully charged.
- It may take some time until printing starts after you select [**Print**], depending on file size and image quality.
- To stop printing, press the <  > button while [**Cancel**] is displayed, then select [**OK**].
- When printing with [**Print order**], you can select [**Resume**] to continue printing the remaining images if you have stopped printing in progress. Note that printing will not resume if any of the following occurs.
  - You change the print order or delete any of the specified images before resuming printing.
  - When index is set and you change the paper setting before resuming printing.
- If a problem occurs during printing, see [Notes](#).

## Print Settings

The screen display and setting options vary depending on the printer. Also, certain settings may not be available. For details, refer to the printer's instruction manual.

### Print settings screen

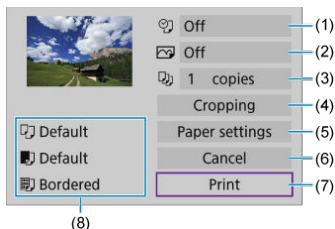

- (1) Sets date or file number printing (☑).
- (2) Sets the printing effects (☑).
- (3) Sets the number of copies to print (☑).
- (4) Sets the print area (☑).
- (5) Sets the paper size, type, and layout (☑, ☑, ☑).
- (6) Returns to the image selection screen.
- (7) Starts the printing.
- (8) The paper size, type, and layout you have set are displayed.

\* Depending on the printer, certain settings may not be selectable.

## Paper settings

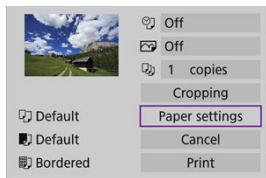

- Select [**Paper settings**].

## [] Setting the paper size

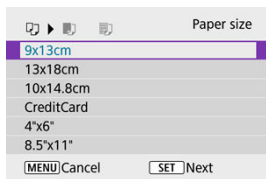

- Select the size of the paper in the printer.

## Setting the paper type

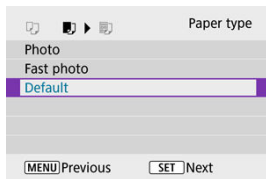

- Select the type of the paper in the printer.

## Setting the page layout

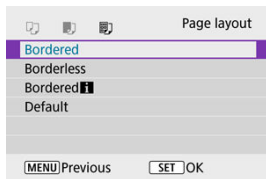



- Select the page layout.

### Caution

- If the image's aspect ratio is different from the printing paper's aspect ratio, the image may be cropped significantly when you print it as a borderless print. Images may also be printed at lower resolution.

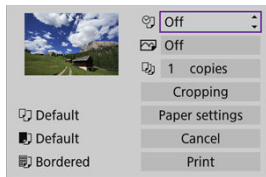
## Setting printing of the date/file number



- Select .
- Select what to print.

## Setting printing effects (image optimization)

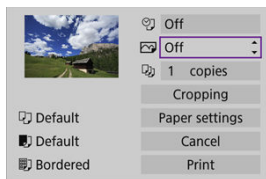



- Select .
- Select printing effects.

### Caution

- ISO speeds may be misidentified in shooting information printed for images shot at an expanded ISO speed (H).
- [Default] in printing effects and other options refers to default settings determined by the printer manufacturer. For [Default] details, refer to the printer instruction manual.

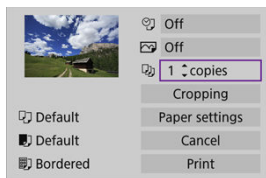
## Setting the number of copies



- Select .
- Select the number of copies to print.



## Cropping the image

**Set cropping immediately before printing.** Changing other print settings after you crop images may require you to crop the images again.

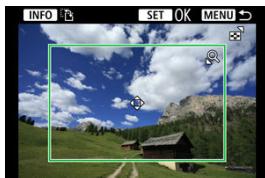

1. Select [Cropping] on the print setting screen.
2. Set the cropping frame size, position, and aspect ratio.
  - The image area within the cropping frame will be printed. The shape of the frame (aspect ratio) can be changed in [Paper settings].

### Resizing the cropping frame size

Press the < Q > or < [Grid] > button to resize the cropping frame.

### Moving the cropping frame

Press the < ▲ > < ▼ > < ◀ > < ▶ > keys to move the frame vertically or horizontally.

### Switching the orientation of the cropping frame

Pressing the < INFO > button will toggle the cropping frame between the vertical and horizontal orientations.

3. Press the < [SET] > button to exit cropping.

- You can check the cropped image area in the upper left of the print setting screen.

## Caution

- Depending on the printer, the cropped image area may not be printed as you specified.
- The smaller the cropping frame, the lower the resolution at which images are printed.

## Note

### Handling printer errors

- If printing does not resume after you resolve a printer error (such as no ink or paper) and select [**Continue**], use buttons on the printer. For details on resuming printing, refer to the printer's instruction manual.

### Error messages

- If a problem occurs during printing, an error message will appear on the camera screen. After fixing the problem, resume printing. For details on how to fix a printing problem, refer to the printer's instruction manual.

### Paper error

- Confirm that paper is loaded correctly.

### Ink error

- Check the printer's ink level and the waste ink tank.

### Hardware error

- Check for any printer problems other than paper and ink problems.

### File error

- The selected image cannot be printed. Images taken with a different camera or images edited with a computer may not be printable.

# Sending Images to a Web Service

☑ [Registering image.canon](#)

☑ [Sending Images](#)

This section describes how to send images to image.canon.

## Registering image.canon

Link the camera to image.canon to send images directly from the camera.

- A computer or smartphone with a browser and internet connection is required.
- You will need to enter an email address used on your computer or smartphone.
- For instructions on how to use image.canon services and details on countries and regions where it is available, visit the image.canon site (<https://image.canon/>).
- Separate ISP connection and access point fees may apply.

### Steps on the camera (1)

1. Select [(?): Wi-Fi/Bluetooth connection].

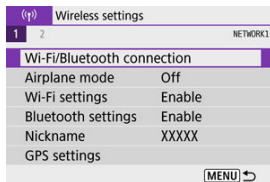

2. Select [(☁️) Upload to Web service].

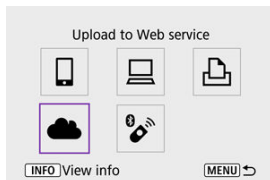

### 3. Select [I Agree].

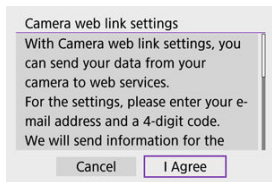

### 4. Establish a Wi-Fi connection.

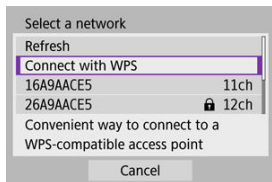

- Connect to an access point via Wi-Fi. Go to step 6 in [Wi-Fi Connection via Access Points](#).

### 5. Enter your email address.

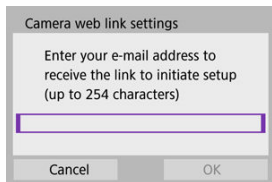

- Enter your email address, then select [OK].

## 6. Enter a four-digit number.

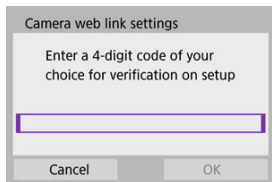

- Enter a four-digit number of your choice, then select **[OK]**.

## 7. Select **[OK]**.

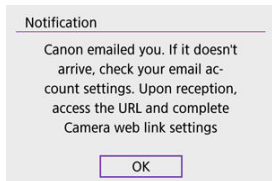

- The [☁️] icon changes to [☁️➡️].

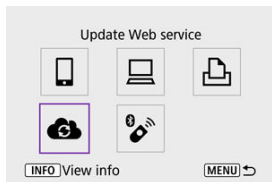

## Steps on the computer or smartphone

### 8. Set up camera web link.

- Access the page in the notification message.
- Follow the instructions to complete the settings on the camera web link settings page.

## Steps on the camera (2)

### 9. Add "image.canon" as a destination.

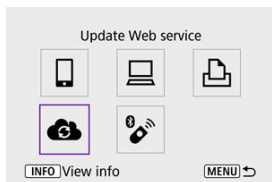

- Select [🌥️].  
image.canon is now added.

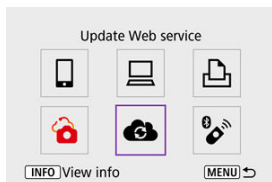

## Sending Images

Images can be sent to image.canon. Original files of images sent to image.canon are retained for 30 days, without storage limitations, and can be downloaded to computers or transferred to other Web services.

### Connecting to image.canon via Wi-Fi

1. Select [(i)]: Wi-Fi/Bluetooth connection].

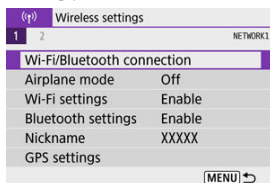

2. Select image.canon.



- If the history [(i)] is displayed, press the < ◀ ▶ > keys to switch screens.



## Sending images individually

### 1. Select an image to send.



- Use the < ☀ > dial or < ◀ ▶ > keys to select an image to send, then press the < (SET) > button.
- To select the image from index display, press the < [ ] > button.

### 2. Select [Send img shown].

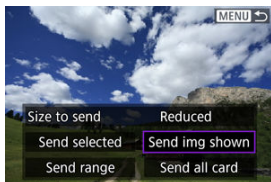

- In [**Size to send**], you can select the image sending size.
- On the screen after images are sent, select [**OK**] to end the Wi-Fi connection.

## Sending multiple selected images

1. Press the <  > button.

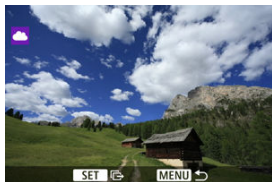







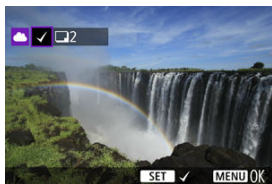

2. Select [Send selected].



3. Select images to send.



- Use the <  > dial or <  > <  > <  > <  > keys to select an image to send, then press the <  > button.
- You can press the <  > button to select the image from 3-image display. To return to the single-image display, press the <  > button.

#### 4. Select [Size to send].

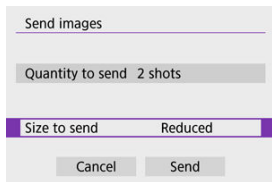

Send images

Quantity to send 2 shots

Size to send Reduced

Cancel Send

- On the displayed screen, select an image size.

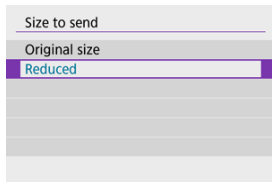

Size to send

Original size

Reduced

#### 5. Select [Send].

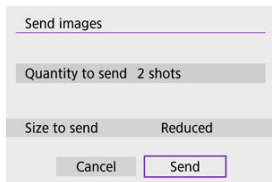

Send images

Quantity to send 2 shots

Size to send Reduced

Cancel Send

- On the screen after images are sent, select **[OK]** to end the Wi-Fi connection.

## Sending a specified range of images

Specify the range of images to send all the images in the range at once.

1. Press the <  > button.

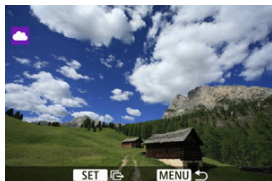

2. Select [Send range].



3. Specify the range of images.

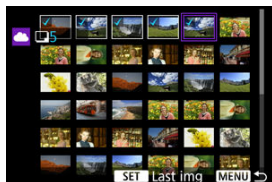

- Select the first image (start point).
- Select the last image (end point).  
Images will be selected and [✓] will appear.
- To cancel the selection, repeat this step.
- You can press the <  > button to change the number of images shown in the index display.

#### 4. Confirm the range.

- Press the < MENU > button.

#### 5. Select [Size to send].

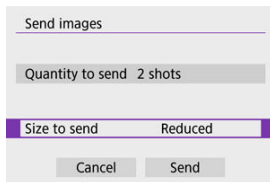

- On the displayed screen, select an image size.

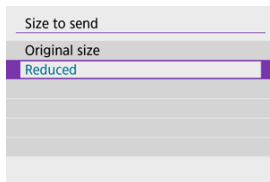

#### 6. Select [Send].

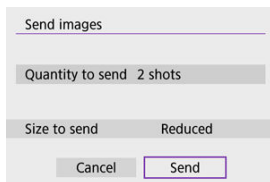

- On the screen after images are sent, select **[OK]** to end the Wi-Fi connection.

## Sending all images on the card

1. Press the <  > button.

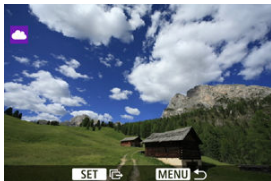

2. Select [Send all card].

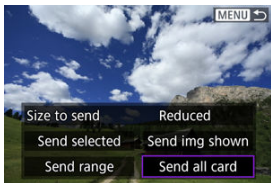

### 3. Select [Size to send].

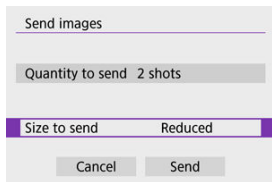

- On the displayed screen, select an image size.

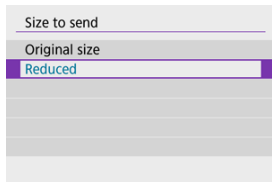

### 4. Select [Send].

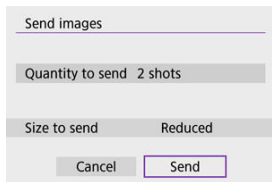

- On the screen after images are sent, select **[OK]** to end the Wi-Fi connection.

## Sending images that match the search conditions

Send all the images that match the search conditions set in [Set image search conditions] at once. For details on [Set image search conditions], see [Setting Image Search Conditions](#).

1. Press the <  > button.



2. Select [Send all found].





### 3. Select [Size to send].

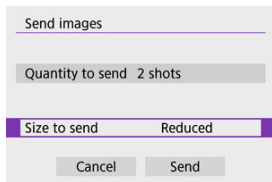

- On the displayed screen, select an image size.

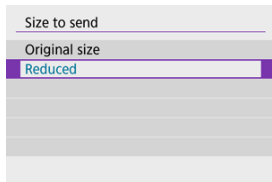

### 4. Select [Send].

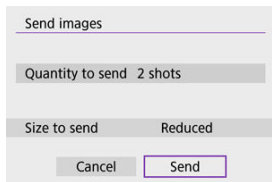

- On the screen after images are sent, select **[OK]** to end the Wi-Fi connection.

#### Caution

- Shooting is not possible when connected via Wi-Fi to image.canon, even if you press the camera's shutter button.



#### Note

- It may not be possible to send certain images with **[Send range]**, **[Send all card]**, or **[Send all found]**.
- When you reduce the image size, all images to be sent at the same time are resized. Note that movies or **S2** size still photos are not reduced.
- **[Reduced]** only applies to still photos shot with cameras of the same model as this one. Still photos shot with other models are sent without resizing.
- A record of sent images can be checked when you access [image.canon](http://image.canon).
- When you use a battery to power the camera, make sure it is fully charged.

# Wi-Fi Connection via Access Points

[☑ Camera Access Point Mode](#)

[☑ Manual IP Address Setup](#)

This section describes how to join a Wi-Fi network via an access point compatible with WPS (PBC mode).

First, check the position of the WPS button and how long to press it. It may take approx. 1 min. to establish a Wi-Fi connection.

---

## 1. Select [(Ⓜ): Wi-Fi/Bluetooth connection].

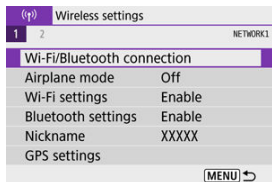



## 2. Select an option.

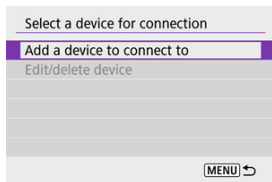

- If the history (Ⓜ) is displayed, press the < ◀ ▶ > keys to switch screens.

### 3. Select [Add a device to connect to].



- The following message is displayed if you have selected [  **Connect to smartphone**]. If Camera Connect is already installed, select [**Do not display**].

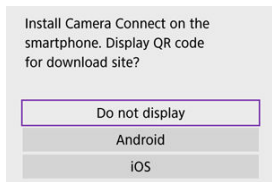

- On the [**Connect to smartphone**] screen displayed next, select [**Connect via Wi-Fi**].

### 4. Select [Switch network].

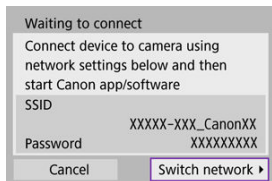

- Displayed when [  ], [  ], or [  ] is selected.

## 5. Select [Connect with WPS].

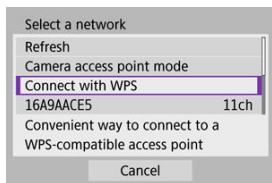

### Note

- For [Camera access point mode] displayed in step 5, see [Camera Access Point Mode](#).

## 6. Select [WPS (PBC mode)].

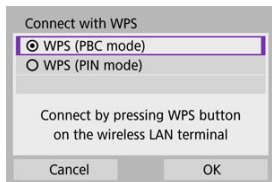

- Select [OK].

## 7. Connect to the access point via Wi-Fi.

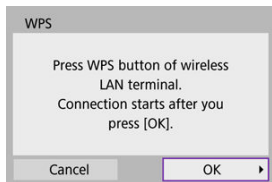

- Press the access point's WPS button.
- Select **[OK]**.

## 8. Select **[Auto setting]**.

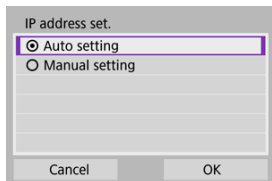

- Select **[OK]** to access the setting screen for the Wi-Fi function.
- If an error occurs with **[Auto setting]**, see [Manual IP Address Setup](#).

## 9. Specify the settings for the Wi-Fi function.

### [📱 Connect to smartphone]

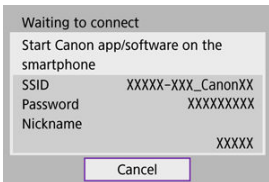

- On the smartphone's Wi-Fi setting screen, tap the SSID (network name) shown on the camera, then enter the password of the access point for the connection.

Go to step 8 in [Wi-Fi Connection without Using Bluetooth](#).

### [🖨️ Remote control (EOS Utility)]

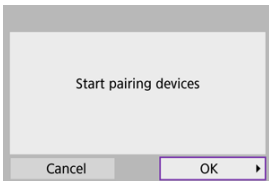

Go to step 7 or 8 in [Steps on the computer \(2\)](#).

### [🖨️ Print from Wi-Fi printer]



Go to step 6 in [Connecting to a Printer via Wi-Fi](#).

### Register image.canon.

Go to step 5 in [Registering image.canon](#).

## Camera Access Point Mode

---

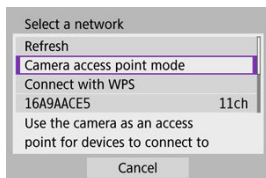

Camera access point mode is a connection mode for connecting the camera directly to each device via Wi-Fi. Displayed when [📺], [📺], or [📺] is selected after [(📶): **Wi-Fi/Bluetooth connection**].



## Manual IP Address Setup

The options displayed vary depending on the Wi-Fi function.

### 1. Select [Manual setting].

IP address set.

Auto setting

Manual setting

Cancel OK

- Select [OK].

### 2. Select an option.

IP address set.

IP address 192.168.1.2

Subnet mask 255.255.255.0

Gateway Disable

Cancel OK

- Select an option to access the screen for numerical input.
- To use a gateway, select [Enable], then select [Address].

Gateway

Enable

Disable

Address

0.0.0.0

Cancel OK

### 3. Enter the desired values.

IP address

192 . 168 . 1 . 3

0123456789

MENU <x> OK Cancel

- Turn the < 🌞 > dial to move the input position in the upper area, and use the < ◀ ▶ > keys to select numbers to enter. Press the < (📎) > button to enter the selected number.
- To delete the number just entered, press the < MENU > button.
- Select [OK] after the numbers have been entered. Display returns to the screen in step 2.

### 4. Select [OK].

IP address set.

IP address	192.168.1.3
Subnet mask	255.255.255.0
Gateway	Disable

Cancel OK ▶

- When you have completed setting the necessary items, select [OK].
- If you are not sure what to enter, see [Checking Network Settings](#), or ask the network administrator or another person knowledgeable about the network.

# Connecting to a Wireless Remote Control

## [Canceling the Pairing](#)

This camera can also be connected to Wireless Remote Control BR-E1 (sold separately, ) via Bluetooth for remote control shooting.

---

### 1. Select []: Wi-Fi/Bluetooth connection].

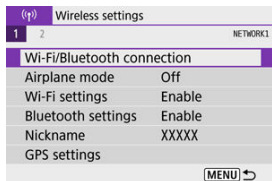

### 2. Select [] Connect to Wireless Remote].

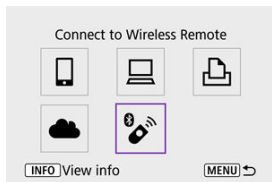

### 3. Select [Add a device to connect to].

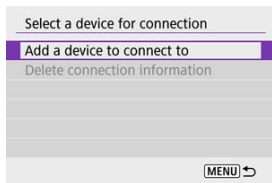

#### 4. Pair the devices.

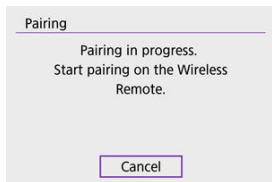

- When the [**Pairing**] screen appears, press and hold the <W> and <T> buttons on the BR-E1 simultaneously for at least 3 sec.
- After a message confirms that the camera is paired with the BR-E1, press the <Ⓜ> button.

#### 5. Set up the camera for remote shooting.

- When shooting still photos, select [] or [] as the drive mode ().
- For movie recording, set [: **Remote control**] to [**Enable**].
- For instructions after the pairing is complete, refer to the BR-E1's Instruction Manual.

#### Caution

- Bluetooth connections consume battery power even after the camera's auto power off is activated.

#### Note

- When you will not use Bluetooth, setting this function to [**Disable**] in step 1 is recommended.

## Canceling the Pairing

Before pairing with a different BR-E1, clear the information about the connected remote control.

1. Select [(P): Wi-Fi/Bluetooth connection].

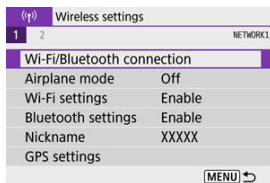

2. Select [P] Connect to Wireless Remote].

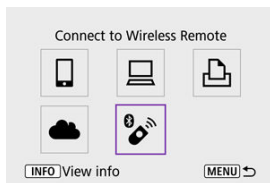

3. Select [Delete connection information].

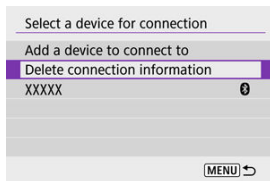

#### 4. Select [OK].

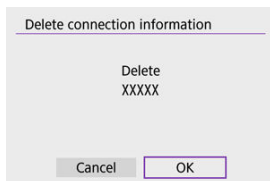

# Reconnecting via Wi-Fi

Follow these steps to reconnect to devices or Web services with registered connection settings.

## 1. Select [(⌘): Wi-Fi/Bluetooth connection].

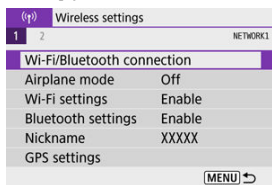

## 2. Select an option.

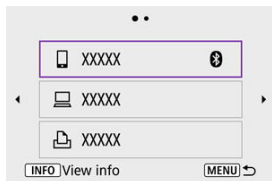

- Select an option to connect to via Wi-Fi from the displayed history. If the option is not shown, press the < ◀ ▶ > keys to switch screens.
- The history is not displayed when **[Connection history]** is set to **[Hide]** (🔒).

### 3. Operate the connected device.

#### Smartphone

- Start Camera Connect.
- If the smartphone's connection destination has been changed, restore the setting to connect via Wi-Fi to the camera or the same access point as the camera.  
When directly connecting the camera to a smartphone via Wi-Fi, “\_Canon0A” is displayed at the end of the SSID.

#### Computer

- On the computer, start the EOS software.
- If the computer's connection destination has been changed, restore the setting to connect via Wi-Fi to the camera or the camera's access point.  
When directly connecting the camera to a computer via Wi-Fi, “\_Canon0A” is displayed at the end of the SSID.

#### Printer

- If the printer's connection destination has been changed, restore the setting to connect via Wi-Fi to the camera or the same access point as the camera.  
When directly connecting the camera to a printer via Wi-Fi, “\_Canon0A” is displayed at the end of the SSID.



# Registering Multiple Connection Settings

You can register up to 10 connection settings for the wireless communication functions.

## 1. Select [(Wi-Fi): Wi-Fi/Bluetooth connection].

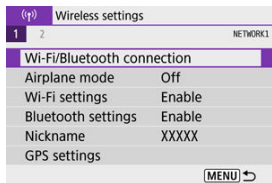

## 2. Select an option.

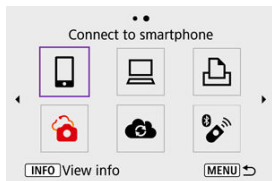

- If the history (📄) is displayed, switch screens with the < << >> > keys.
- For details on [📱 Connect to smartphone], see [Connecting to a Smartphone](#).
- For details on [💻 Remote control (EOS Utility)], see [Connecting to a Computer via Wi-Fi](#).
- For details on [🖨️ Print from Wi-Fi printer], see [Connecting to a Printer via Wi-Fi](#).
- When sending images to a Web service, see [Sending Images to a Web Service](#).

### Note

- To delete connection settings, see [Changing or Deleting Connection Settings](#).

# Airplane Mode

You can temporarily disable Wi-Fi and Bluetooth functions.

## 1. Select [**↑**]: Airplane mode].

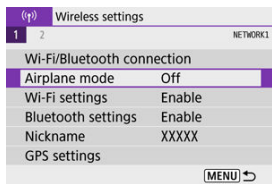

## 2. Set to [On].

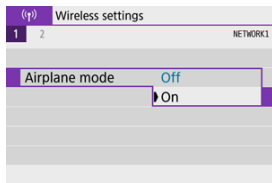

- [**↑**] is displayed on the screen.

### Note

- [**↑**] may not be displayed in still photo shooting, movie recording, or playback, depending on display settings. If it is not displayed, press the <INFO> button repeatedly to access detailed information display.

## 1. Select [(Ⓜ): Wi-Fi settings].

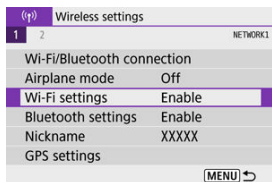

## 2. Select an option.

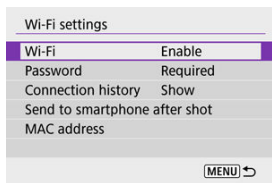

- **Wi-Fi**  
When the use of electronic devices and wireless devices is prohibited, such as on board airplanes or in hospitals, set it to **[Disable]**.
- **Password**  
Set to **[None]** to allow Wi-Fi connections without a password (except when connecting to an access point via Wi-Fi).
- **Connection history**  
You can set the connection history for devices connected via Wi-Fi to **[Show]** or **[Hide]**.
- **Send to smartphone after shot**  
Images can be transferred to a smartphone automatically (☑).
- **MAC address**  
You can check the MAC address of the camera.

# Bluetooth Settings

---

## 1. Select [(Ⓜ)]: Bluetooth settings].

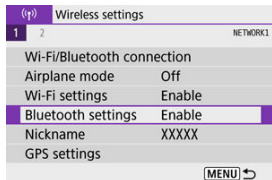

## 2. Select an option.

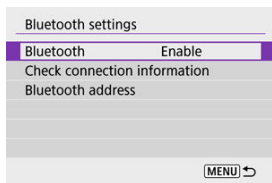

- **Bluetooth**  
If you will not use the Bluetooth function, select [**Disable**].
- **Check connection information**  
You can check the name and communication status of the paired device.
- **Bluetooth address**  
You can check the camera's Bluetooth address.

# Nickname

---

You can change the camera nickname (displayed on smartphones and other cameras) as needed.

---

## 1. Select [(P): Nickname].

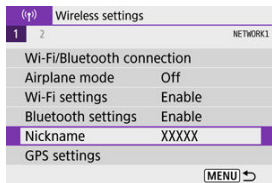

## 2. Enter text using the [Virtual Keyboard Operations](#).



- When you finish entering characters, press the < MENU > button.

# GPS Settings

---

[GPS via Mobile](#)

[GPS Connection Display](#)

## GPS via Mobile

---

You can geotag images with a Bluetooth enabled smartphone. Complete these settings after installing the dedicated Camera Connect app (📷) on the smartphone.

1. On the smartphone, activate location services.

2. Establish a Bluetooth connection.

- Start Camera Connect and pair the camera and smartphone via Bluetooth.

3. Select [(📷)]: GPS settings].

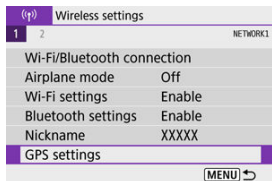

**4. Select [GPS via mobile].**

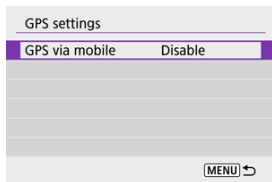

**5. Select [Enable].**

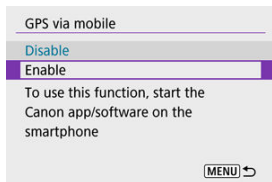

**6. Take the picture.**

- Images are geotagged with the information from the smartphone.

## GPS Connection Display

You can check the status of smartphone location information acquisition in the GPS connection icon on the screens for still photo shooting or movie recording (📷 and 🎥, respectively).

- Gray: Location services are off
- Blinking: Location information cannot be acquired
- On: Location information acquired

### Geotagging images as you shoot

Images you shoot while the GPS icon is on are geotagged.

### Geotagging information

You can check the location information added to your shots on the shooting information screen (📷).



- (1) Latitude
- (2) Longitude
- (3) Elevation
- (4) UTC (Coordinated Universal Time)



 **Caution**

- The smartphone can acquire location information only while it is paired with the camera via Bluetooth.
- Direction information is not acquired.
- Acquired location information may not be accurate, depending on traveling conditions or smartphone status.
- It may take some time to acquire location information from the smartphone after you turn the camera on.
- Location information is no longer acquired after any of the following operations.
  - Pairing with a wireless remote control via Bluetooth
  - Turning the camera off
  - Quitting Camera Connect
  - Deactivating location services on the smartphone
- Location information is no longer acquired in any of the following situations.
  - The camera power turns off
  - The Bluetooth connection is ended
  - The smartphone's remaining battery level is low

 **Note**

- Coordinated Universal Time, abbreviated as UTC, is essentially the same as Greenwich Mean Time.
- For movies, the GPS information initially acquired is added.

# Changing or Deleting Connection Settings

To change or delete the connection settings, terminate the Wi-Fi connection first.

## 1. Select [(F1): Wi-Fi/Bluetooth connection].

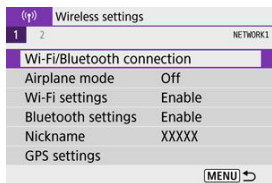

## 2. Select an option.



- If the history (📄) is displayed, press the < ◀▶ > keys to switch screens.

## 3. Select [Edit/delete device].

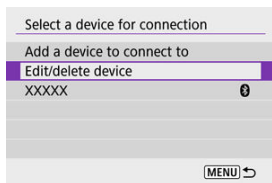

- You can change the Bluetooth connection by selecting a smartphone labeled with (📱) in gray. After the [Connect to smartphone] screen is displayed, select [Pair via Bluetooth], then press < (📱) > on the next screen.

4. Select the device for which to change or delete the connection settings.

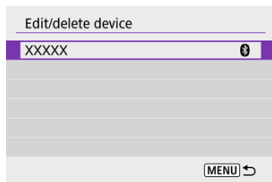

5. Select an option.

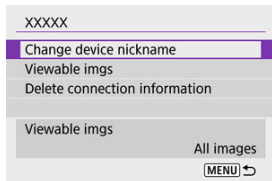

- Change or delete the connection settings on the displayed screen.
- **Change device nickname**  
You can change the nickname using the virtual keyboard (📄).
- **Viewable imgs** (📄)  
Displayed when [📱 **Connect to smartphone**] is selected. Settings will appear at the bottom of the screen.
- **Delete connection information**  
When deleting connection information for a paired smartphone, also delete the camera information registered on the smartphone (📄).

 **Note**

- To delete image.canon connection settings, visit the image.canon website.

# Resetting Communication Settings

All wireless communication settings can be deleted. By deleting the wireless communication settings, you can prevent their information from being exposed when you lend or give your camera to other people.

## 1. Select [(F): Reset communication settings].

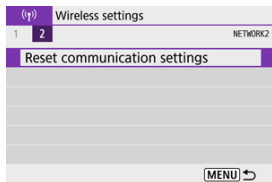

## 2. Select [OK].



### ! Caution

- If you have paired the camera with a smartphone, on the smartphone's Bluetooth settings screen, delete the connection information of the camera for which you restored default wireless communication settings.

### 📱 Note

- All wireless communication settings can be cleared by selecting the [Communication settings] option for [Other settings] in [(F): Reset camera].

## View Info Screen

---

You can check error details and the camera's MAC address.

---

1. Select [(i)]: **Wi-Fi/Bluetooth connection**.

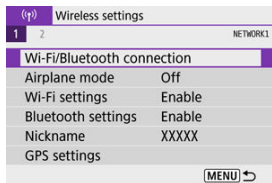

2. Press the <INFO> button.

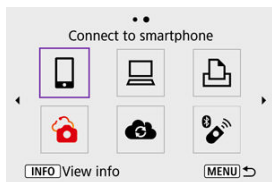

- The [View info] screen will appear.

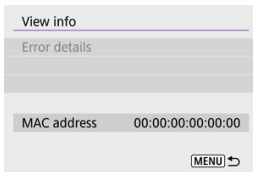

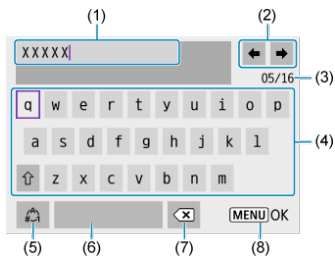

- If an error has occurred, press the <(i)> button to display error details.

## Virtual Keyboard Operations



- 
- (1) Input area, for entering text
- 
- (2) Cursor keys, for moving in the input area
- 
- (3) Current no. of characters/no. available
- 
- (4) Keyboard
- 
- (5) Switch input modes
- 
- (6) Space
- 
- (7) Delete a character in the input area
- 
- (8) Exit input
- 

- To move the cursor within (1), you can also turn the <  > dial.
- To move between (2) and (4)–(7), use the < ▲ >< ▼ >< ◀ >< ▶ > keys.
- Press the <  > button to confirm input or when switching input modes.

## Responding to Error Messages

When an error occurs, display the details of the error by following one of the procedures below. Then, eliminate the cause of the error by referring to the examples shown in this chapter.

- On the **[View info]** screen, press the <  > button.
- Select **[Error details]** on the **[Wi-Fi on]**.

<a href="#">11</a>	<a href="#">12</a>							
<a href="#">21</a>	<a href="#">22</a>	<a href="#">23</a>						
<a href="#">61</a>	<a href="#">63</a>	<a href="#">64</a>	<a href="#">65</a>	<a href="#">66</a>	<a href="#">67</a>	<a href="#">68</a>	<a href="#">69</a>	
<a href="#">91</a>								
<a href="#">121</a>	<a href="#">125</a>	<a href="#">126</a>	<a href="#">127</a>					
<a href="#">130</a>	<a href="#">131</a>	<a href="#">132</a>	<a href="#">133</a>	<a href="#">134</a>	<a href="#">135</a>			
<a href="#">141</a>	<a href="#">142</a>							



### Note

- When an error occurs, **[Err\*\*]** is displayed in the upper right of the **[Wi-Fi/Bluetooth connection]** screen. It disappears when the camera's power is set to **<OFF>**.

## 11: Connection target not found

- **In the case of [📷], is Camera Connect running?**
  - Establish a connection using Camera Connect (🔗).
- **In the case of [📱], is the EOS software running?**
  - Start the EOS software and reestablish the connection (🔗).
- **In the case of [🖨️], is the power of the printer on?**
  - Turn on the printer.
- **Are the camera and the access point set to use the same password for authentication?**
  - This error occurs if the passwords do not match when the authentication method for encryption is set to **[Open system]**.  
Check upper- and lower-case letters, and make sure the correct password for authentication is set on the camera (🔗).

## 12: Connection target not found

- **Is the power of the target device and access point on?**
  - Turn on the target device and access point, then wait a while. If a connection still cannot be established, perform the procedures to establish the connection again.



## 21: No address assigned by DHCP server

### What to check on the camera

- **On the camera, IP address is set to [Auto setting]. Is this the correct setting?**
  - If no DHCP server is used, specify the settings after setting the IP address to **[Manual setting]** on the camera (🔗).

### What to check on the DHCP server

- **Is the power of the DHCP server on?**
  - Turn on the DHCP server.
- **Are there enough addresses for assignment by the DHCP server?**
  - Increase the number of addresses assigned by the DHCP server.
  - Remove devices assigned addresses by the DHCP server from the network to reduce the number of addresses in use.
- **Is the DHCP server working correctly?**
  - Check the DHCP server settings to make sure it is working correctly as a DHCP server.
  - If applicable, ask your network administrator to ensure the DHCP server is available.

### What to check on the camera

- **On the camera, does the DNS server's IP address setting match the server's actual address?**
  - Set the IP address to **[Manual setting]**, and on the camera, specify the same IP address as the DNS server used (🔗).

### What to check on the DNS server

- **Is the power of the DNS server on?**
  - Turn on the DNS server.
- **Are the DNS server settings for IP addresses and the corresponding names correct?**
  - On the DNS server, make sure IP addresses and the corresponding names are entered correctly.
- **Is the DNS server working correctly?**
  - Check the DNS server settings to make sure it is working correctly as a DNS server.
  - If applicable, ask your network administrator to ensure the DNS server is available.

### What to check on the network as a whole

- **Does your network include a router or similar device that serves as a gateway?**
  - If applicable, ask your network administrator for the network gateway address and set it on the camera (🔗, 🔗).
  - Make sure that the gateway address setting is correctly entered on all network devices including the camera.

## 23: Device with same IP address exists on selected network

- **Is another device on the camera network using the same IP address as the camera?**
  - Change the camera's IP address to avoid using the same address as another device on the network. Otherwise, change the IP address of the device that has a duplicate address.
  - If the camera's IP address is set to **[Manual setting]** in network environments using a DHCP server, change the setting to **[Auto setting]** (🔗).



### Note

#### Responding to error messages 21–23

- Also check the following points when responding to errors numbered 21–23.  
**Are the camera and the access point set to use the same password for authentication?**
  - This error occurs if the passwords do not match when the authentication method for encryption is set to **[Open system]**. Check upper- and lower-case letters, and make sure the correct password for authentication is set on the camera (🔗).

## 61: Selected SSID wireless LAN network not found

- **Are any obstacles blocking the line of sight between the camera and the antenna of the access point?**
  - Move the antenna of the access point to a position clearly visible from the point of view of the camera (🔗).

### What to check on the camera

- **Does the SSID set on the camera match that of the access point?**
  - Check the SSID at the access point, then set the same SSID on the camera.

### What to check at the access point

- **Is the access point turned on?**
  - Turn on the power of the access point.
- **If filtering by MAC address is active, is the MAC address of the camera in use registered at the access point?**
  - Register the MAC address of the camera used to the access point. The MAC address can be checked on the [View info] screen (🔗).

## 63: Wireless LAN authentication failed

- **Are the camera and the access point set to use the same authentication method?**
  - The camera supports the following authentication methods: [Open system], [Shared key], and [WPA/WPA2-PSK].
- **Are the camera and the access point set to use the same password for authentication?**
  - Check upper- and lower-case letters, and make sure the correct password for authentication is set on the camera.
- **If filtering by MAC address is active, is the MAC address of the camera in use registered at the access point?**
  - Register the MAC address of the camera used to the access point. The MAC address can be checked on the [View info] screen (🔗).

## 64: Cannot connect to wireless LAN terminal

- **Are the camera and the access point set to use the same encryption method?**
  - The camera supports the following encryption methods: WEP, TKIP, and AES.
- **If filtering by MAC address is active, is the MAC address of the camera in use registered at the access point?**
  - Register the MAC address of the camera used to the access point. The MAC address can be checked on the **[View info]** screen (🔗).

## 65: Wireless LAN connection lost

- **Are any obstacles blocking the line of sight between the camera and the antenna of the access point?**
  - Move the antenna of the access point to a position clearly visible from the point of view of the camera.
- **The Wi-Fi connection was lost for some reason, and the connection cannot be restored.**
  - The following are possible reasons: excessive access to the access point from another device, a microwave oven or similar appliance in use nearby (interfering with IEEE 802.11b/g/n (2.4 GHz band)), or influence of rain or high humidity (🔗).

## 66: Incorrect wireless LAN password

- **Are the camera and the access point set to use the same password for authentication?**
  - Check upper- and lower-case letters, and make sure the correct password for authentication is set on the camera.

## 67: Incorrect wireless LAN encryption method

- **Are the camera and the access point set to use the same encryption method?**
  - The camera supports the following encryption methods: WEP, TKIP, and AES.
- **If filtering by MAC address is active, is the MAC address of the camera in use registered at the access point?**
  - Register the MAC address of the camera used to the access point. The MAC address can be checked on the **[View info]** screen (🔗).

### 68: Cannot connect to wireless LAN terminal. Retry from the beginning.

- **Did you hold down the access point's WPS (Wi-Fi Protected Setup) button for the specified period of time?**
  - Hold down the WPS button for the period of time specified in the access point's instruction manual.
- **Are you trying to establish a connection near the access point?**
  - Try establishing the connection when both devices are within reach of each other.

### 69: Multiple wireless LAN terminals have been found. Cannot connect. Retry from the beginning.

- **Connection is in progress by other access points in Pushbutton Connection mode (PBC mode) of WPS (Wi-Fi Protected Setup).**
  - Wait a while before trying to establish the connection.

### 91: Other error

- **A problem other than error code number 11 to 69 occurred.**
  - Turn the camera's power switch off and on.

### 121: Not enough free space on server

- **The target Web server does not have enough free space.**
  - Delete unnecessary images on the Web server, check the free space on the Web server, then try sending the data again.

### 125: Check the network settings

- **Is the network connected?**
  - Check the connection status of the network.

### 126: Could not connect to server

- **Could not connect to the Web service.**
  - Try accessing the service again later.
- **Is the network connected?**
  - Check the connection status of the network.

### 127: An error has occurred

- **A problem other than error code number 121 to 126 occurred while the camera is connected to the Web service.**
  - Try again to establish the Wi-Fi connection to image.canon.

### 130: The server is currently busy Please wait a moment and try again

- **The image.canon site is busy at the moment.**
  - Try accessing image.canon over Wi-Fi again later.

### 131: Try again

- **An error occurred when connecting to image.canon over Wi-Fi.**
  - Try again to establish the Wi-Fi connection to image.canon.

### 132: Error detected on server Try again later

- **The image.canon site is currently offline for maintenance.**
  - Try accessing image.canon over Wi-Fi again later.

### 133: Cannot log in to Web service

- **An error occurred when signing in to image.canon.**
  - Check the image.canon settings.
  - Try accessing image.canon over Wi-Fi again later.

### 134: Set the correct date and time

- **The date, time, and time zone settings are incorrect.**
  - Check the [: Date/Time/Zone] settings.

### 135: Web service settings have been changed

- **The settings for image.canon were changed.**
  - Check the image.canon settings.

#### **141: Printer is busy. Try connecting again.**

- **Is the printer performing a printing process?**
  - Try again to establish the Wi-Fi connection to the printer after the printing process is finished.
- **Is another camera connected to the printer via Wi-Fi?**
  - Try again to establish the Wi-Fi connection to the printer after the Wi-Fi connection to the other camera has been terminated.

#### **142: Could not acquire printer information. Reconnect to try again.**

- **Is the power of the printer on?**
  - Try again to establish the Wi-Fi connection after turning on the printer.



## **Wireless Communication Function Precautions**

---

- [Distance Between the Camera and the Smartphone](#)
- [Installation Location of Access Point Antenna](#)
- [Nearby Electronic Devices](#)
- [Precautions for Using Multiple Cameras](#)

If the transmission rate drops, the connection is lost, or other problems occur when using the wireless communication functions, try the following corrective actions.

---

## Distance Between the Camera and the Smartphone

---

If the camera is too far from the smartphone, a Wi-Fi connection may not be established even when Bluetooth connection is possible. In this case, bring the camera and the smartphone closer together, then establish a Wi-Fi connection.

## Installation Location of Access Point Antenna

---

- When using indoors, install the device in the room where you are using the camera.
- Install the device where people or objects do not come between the device and the camera.

## Nearby Electronic Devices

---

If the Wi-Fi transmission rate drops because of the influence of the following electronic devices, stop using them or move further away from the devices to transmit communication.

- The camera communicates over Wi-Fi via IEEE 802.11b/g/n using radio waves in the 2.4 GHz band. For this reason, the Wi-Fi transmission rate will drop if there are Bluetooth devices, microwave ovens, cordless telephones, microphones, smartphones, other cameras, or similar devices operating on the same frequency band nearby.

## Precautions for Using Multiple Cameras

---

- When connecting multiple cameras to one access point via Wi-Fi, make sure the cameras' IP addresses are different.
- When multiple cameras are connected to one access point via Wi-Fi, the transmission rate drops.
- When there are multiple IEEE 802.11b/g/n (2.4 GHz band) access points, leave a gap of five channels between each Wi-Fi channel to reduce radio wave interference. For example, use channels 1, 6, and 11, channels 2 and 7, or channels 3 and 8.

## Security

---

If security settings have not been properly set, the following problems may occur.

- **Transmission monitoring**  
Third parties with malicious intent may monitor wireless LAN transmissions and attempt to acquire the data you are sending.
- **Unauthorized network access**  
Third parties with malicious intent may gain unauthorized access to the network you are using to steal, modify, or destroy information. Additionally, you could fall victim to other types of unauthorized access such as impersonation (where someone assumes an identity to gain access to unauthorized information) or springboard attacks (where someone gains unauthorized access to your network as a springboard to cover their tracks when infiltrating other systems).

It is recommended to make use of the systems and functions to thoroughly secure your network, preventing these types of problems from occurring.

## Checking Network Settings

---

### Windows

Open the Windows **[Command Prompt]**, then enter `ipconfig/all` and press the **<Enter>** key. In addition to the IP address assigned to the computer, the subnet mask, gateway, and DNS server information are also displayed.

### macOS

In macOS, open the **[Terminal]** application, enter `ifconfig -a`, and press the **<Return>** key. The IP address assigned to the computer is indicated in the **[enX]** item (X: number) next to **[inet]**, in the format `***.***.***.***`.

For information about the **[Terminal]** application, refer to the macOS help.

To avoid using the same IP address for the computer and other devices on the network, change the rightmost number when configuring the IP address assigned to the camera in the processes described in [Manual IP Address Setup](#).

Example: 192.168.1.**10**

# Wireless Communication Status

Wireless communication status can be checked on the screen.

## Shooting functions screen

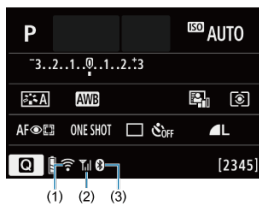



## Information display screen during playback



- (1) Wi-Fi function
- (2) Wireless signal strength
- (3) Bluetooth function

Communication Status		Screen	
		Wi-Fi Function	Wireless Signal Strength
Not connected	Wi-Fi: Disable	Wi-Fi Off	Off
	Wi-Fi: Enable	Wi-Fi Off	
Connecting		Wi-Fi (Blinking)	Signal strength icon
Connected		Wi-Fi	Signal strength icon
Sending data		Wi-Fi (← →)	Signal strength icon
Connection error		Wi-Fi (Blinking)	Signal strength icon

## Bluetooth Function Indicator

Bluetooth Function	Connection Status	Screen
Other than [Disable]	Bluetooth connected	
	Bluetooth not connected	
[Disable]	Bluetooth not connected	Not displayed

# Set-up

---

This chapter describes menu settings on the set-up (**[F]**) tab.

- ☆ to the right of page titles indicates functions only available in Creative Zone modes (<P>, <Tv>, <Av>, or <M>).
  - [Tab Menus: Set-up](#)
  - [Folder Settings](#)
  - [File Numbering](#)
  - [Card Formatting](#)
  - [Auto Rotate](#)
  - [Adding Orientation Information to Movies](#)
  - [Date/Time/Zone](#)
  - [Language](#)
  - [Video System](#)
  - [Beeps](#)
  - [Power Saving](#)
  - [Eco Mode](#)
  - [Display Settings](#)
  - [Screen Brightness](#)
  - [Viewfinder Brightness](#)
  - [HDMI Resolution](#)
  - [Resetting the Camera](#) ☆
  - [Custom Functions \(C.Fn\)](#) ☆
  - [Copyright Information](#) ☆
  - [Other Information](#)

## Tab Menus: Set-up

### ● Set-up 1

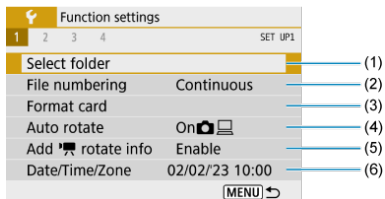

- (1) [Select folder](#)
- (2) [File numbering](#)
- (3) [Format card](#)
- (4) [Auto rotate](#)
- (5) [Add rotate info](#)
- (6) [Date/Time/Zone](#)

### ● Set-up 2

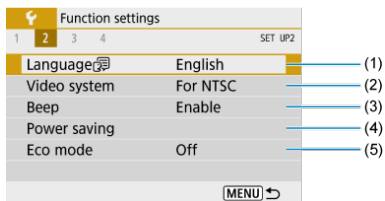

- (1) [Language](#)
- (2) [Video system](#)
- (3) [Beep](#)
- (4) [Power saving](#)
- (5) [Eco mode](#)



### ● Set-up 3

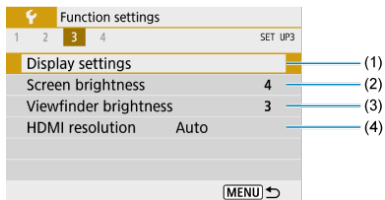

- (1) [Display settings](#)
- (2) [Screen brightness](#)
- (3) [Viewfinder brightness](#)
- (4) [HDMI resolution](#)

### ● Set-up 4

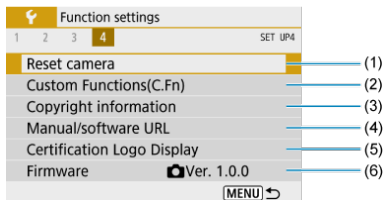

- (1) [Reset camera](#)
- (2) [Custom Functions\(C.Fn\)](#)☆
- (3) [Copyright information](#)☆
- (4) [Manual/software URL](#)
- (5) [Certification Logo Display](#)☆
- (6) [Firmware](#)☆

- In Basic Zone modes, the following screen is displayed for [F4].

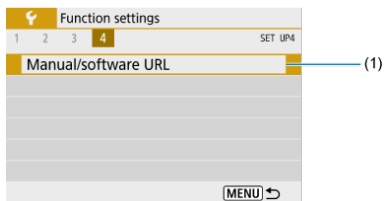

(1) [Manual/software URL](#)

# Folder Settings

---

[Creating a Folder](#)

[Selecting a Folder](#)

You can freely create and select the folder where the captured images are to be saved.

---

## Creating a Folder

---

### 1. Select [: Select folder].

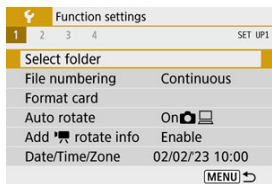

### 2. Select [Create folder].

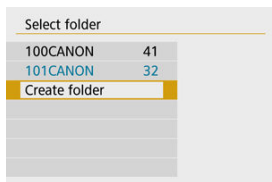

**3. Select [OK].**

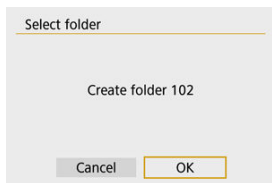

## Selecting a Folder

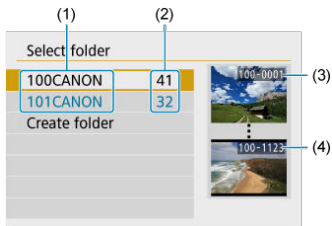

(1) Folder name

(2) Number of images in folder

(3) Lowest file number

(4) Highest file number

- Select a folder on the folder selection screen.
- Captured images are stored in your selected folder.

### Note

#### Folders

- A folder can contain up to 9999 images (file number 0001–9999). When a folder becomes full, a new folder with the folder number increased by one is created automatically. Also, if manual reset (Ⓢ) is executed, a new folder will be created automatically. Folders numbered from 100 to 999 can be created.

#### Creating folders with a computer

- With the card open on the screen, create a new folder with "DCIM" as the name. Open the DCIM folder and create as many folders as necessary to save and organize your images. "100ABC\_D" is the required format for folder names, and the first three digits must be a folder number in the range 100–999. The last five characters can be any combination of upper- and lower-case letters from A to Z, numerals, and the underscore "\_". The space cannot be used. Also note that two folder names cannot share the same three-digit folder number (for example, "100ABC\_D" and "100W\_XYZ") even if the remaining five characters in each name are different.

# File Numbering

---

- [Continuous](#)
- [Auto Reset](#)
- [Manual Reset](#)

The captured images saved in a folder are assigned a file number from 0001 to 9999. You can change how the image files are numbered.

(Example)  
**IMG\_0001.JPG**  
|  
(1)  
(1) File number

---

## 1. Select [: File numbering].

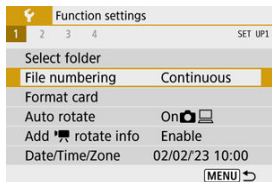

## 2. Set the item.

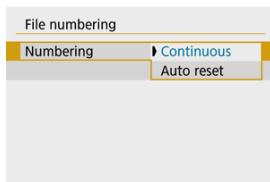

- Select [**Numbering**].
- Select [**Continuous**] or [**Auto reset**].

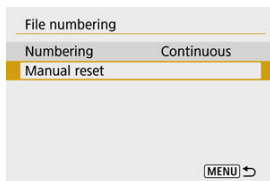

- If you want to reset the file numbering, select [**Manual reset**] (🔗).

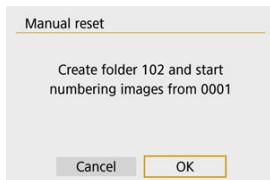

- Select [**OK**] to create a new folder, and the file number will start with 0001.

### Caution

- If the file number in folder 999 reaches 9999, shooting will not be possible even if the card still has free space. After a message requesting you to replace the card is displayed, switch to a new card.

### For continuous file numbering regardless of switching cards or creating folders

Even after you replace the card or create a new folder, the file numbering continues in sequence up to 9999. This is useful when you want to save images numbered anywhere between 0001 to 9999 on multiple cards or in multiple folders into one folder on a computer. If the replacement card or existing folder already contains images recorded previously, the file numbering of the new images may continue from the file numbering of the existing images on the card or in the folder. If you want to use continuous file numbering, it is recommended that you use a newly formatted card each time.

#### File numbering after replacing the card

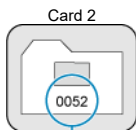
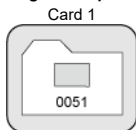

(1)

(1) Next sequential file number

#### File numbering after creating a folder

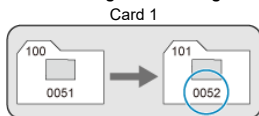



### For restarting file numbering from 0001 after switching cards or creating folders

When you replace the card or create a folder, the file numbering restarts from 0001 for the new images saved. This is useful if you want to organize images by cards or folders. If the replacement card or existing folder already contains images recorded previously, the file numbering of the new images may continue from the file numbering of the existing images on the card or in the folder. If you want to save images with the file numbering starting from 0001, use a newly formatted card each time.

#### File numbering after replacing the card

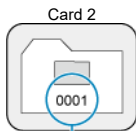
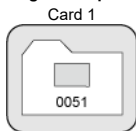

(1)

(1) File numbering is reset

#### File numbering after creating a folder

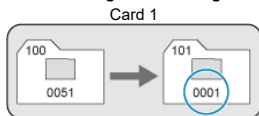

### **For resetting file numbering to 0001 or starting from 0001 in new folders**

When you reset the file numbering manually, a new folder is created automatically and the file numbering of images saved to that folder starts from 0001.

This is useful, for example, if you want to use different folders for the images taken yesterday and the ones taken today.

# Card Formatting

If the card is new or was previously formatted (initialized) by another camera or computer, format the card with this camera.

## Caution

- When the card is formatted, all images and data on the card will be erased. Even protected images will be erased, so make sure there is nothing you need to keep. If necessary, transfer the images and data to a computer, etc. before formatting the card.

### 1. Select [🔧: Format card].

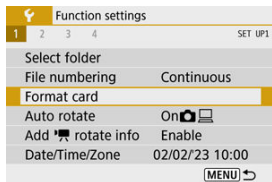

### 2. Format the card.

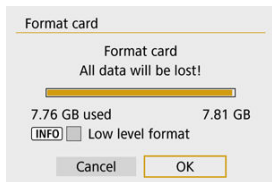

- Select [OK].

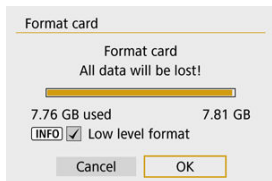

- For low-level formatting, press the < **INFO** > button to add a checkmark [✓] to [**Low level format**], then select [**OK**].

#### Note

- The card capacity displayed on the card format screen may be smaller than the capacity indicated on the card.
- This device incorporates exFAT technology licensed from Microsoft.

### Conditions requiring card formatting

---

- **The card is new.**
- **The card was formatted by a different camera or a computer.**
- **The card is full of images or data.**
- **A card-related error is displayed.**

### Low-level formatting

- Perform low-level formatting if the card's writing or reading speed seems slow or if you want to totally erase the data on the card.
- Since low-level formatting will format all recordable sectors on the card, the formatting will take longer than normal formatting.
- During low-level formatting, you can cancel formatting by selecting [**Cancel**]. Even in this case, normal formatting will already be complete and you can use the card as usual.

## Card file formats

- **SD/SDHC cards will be formatted in FAT32. SDXC cards will be formatted in exFAT.**
- Individual movies recorded to exFAT cards are recorded as a single file (without splitting them into multiple files) even if they exceed 4 GB, so the resulting movie file will exceed 4 GB.



### Caution

- It may not be possible to use SDXC cards formatted with this camera in other cameras. Also note that exFAT-formatted cards may not be recognized by some computer operating systems or card readers.
- Formatting or erasing data on a card does not completely erase the data. Be aware of this when selling or discarding the card. When disposing of cards, take steps to protect personal information if necessary, as by physically destroying cards.

# Auto Rotate

---

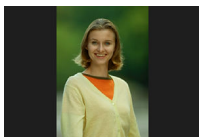



You can change the auto rotation setting that straightens images shot in vertical orientation when they are displayed.

---

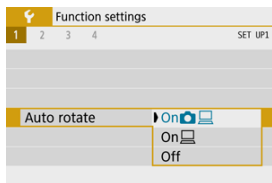
## 1. Select [: Auto rotate].



## 2. Select an option.

- **On**   
Automatically rotates images for display on both the camera and computers.
- **On**   
Automatically rotates images only for display on computers.
- **Off**

### Caution

- Images captured with auto rotation set to **[Off]** will not rotate during playback even if you later set auto rotation to **[On]**.



#### Note

- If a picture is taken while the camera is aimed up or down, automatic rotation to the proper orientation for viewing may not be performed correctly.
- If images are not rotated automatically on a computer, try using EOS software.

# Adding Orientation Information to Movies

For movies recorded with the camera held vertically, orientation information indicating which side is up can be added automatically to enable playback in the same orientation on smartphones or other devices.

## 1. Select [📷: Add 📱 rotate info].

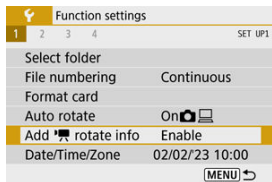

## 2. Select an option.

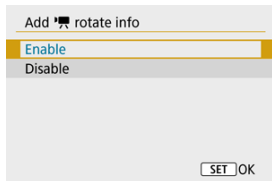

- **Enable**  
Play movies on smartphones or other devices in the orientation in which they were recorded.
- **Disable**  
Play movies horizontally on smartphones or other devices, regardless of the recording orientation.

### Note

- Movies are played horizontally on the camera, regardless of the [📷: Add 📱 rotate info] setting.



## Date/Time/Zone

---

When you turn on the power for the first time or if the date/time/zone have been reset, follow these steps to set the time zone first.

By setting the time zone first, you can simply adjust this setting as needed in the future and the date/time will be updated to match it.

Since the captured images will be appended with the shooting date and time information, be sure to set your date/time.

---

### 1. Select [: Date/Time/Zone].

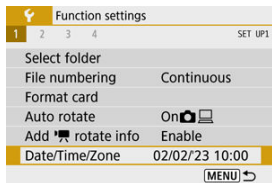

## 2. Set the time zone.

Date/Time/Zone

Time zone ±00:00

02 . 02 . 2023 10 : 00 : 00

mm/dd/yy

 London

OK Cancel

- Use the <◀>>▶> keys to select [Time zone].
- Press the <Ⓜ> button.

Zone/Time difference

02/02/2023 10:00:00

Zone

London

Time difference + 00 : 00

OK Cancel

- Press the <Ⓜ> button.

Time zone

02/02/2023 10:00:00

São Paulo	-03:00
Fernando de Noronha	-02:00
Azores	-01:00
London	±00:00
Paris	+01:00

- Use the <▲>>▼> keys to select the time zone, then press the <Ⓜ> button.
- If your time zone is not listed, press the <MENU> button, then set the difference from UTC in [Time difference].

Zone/Time difference

02/02/2023 10:00:00

Zone

-----

Time difference + 09 : 15

OK Cancel

- Use the < ◀ ▶ > keys to select a [Time difference] option (+/- hour/minute), then press the < (SET) > button.
- Set with the < ▲ > ▼ > keys, then press the < (SET) > button.
- After entering the time zone or time difference, use the < ◀ ▶ > keys to select [OK].

### 3. Set the date and time.

Date/Time/Zone

(02/02/2023)

02 . 02 . 2023 10 : 00 : 00

mm/dd/yy

🌐 London

OK Cancel

- Use the < ◀ ▶ > keys to select an item, then press the < (SET) > button.
- Set with the < ▲ > ▼ > keys, then press the < (SET) > button.

#### 4. Set daylight saving time.

The screenshot shows the 'Date/Time/Zone' menu. At the top, it says 'Date/Time/Zone'. Below that is a grey bar with the text 'Daylight saving time off'. Underneath, the date and time are displayed as '02 . 02 . 2023 10 : 00 : 00'. Below the date is the label 'mm/dd/yy'. The location is set to 'London' with a sun icon and a downward arrow next to it. At the bottom are 'OK' and 'Cancel' buttons.

- Set it as necessary.
- Use the <◀>>▶> keys to select [☀️], then press the <⏪> button.
- Use the <▲>>▼> keys to select [☀️], then press the <⏪> button.
- When the daylight saving time is set to [☀️], the time set in step 3 will advance by 1 hour. If [☀️] is set, the daylight saving time will be canceled and the time will go back by 1 hour.

#### 5. Exit the setting.

The screenshot shows the 'Date/Time/Zone' menu. At the top, it says 'Date/Time/Zone'. Below that is a grey bar with the text '(02/02/2023)'. Underneath, the date and time are displayed as '02 . 02 . 2023 10 : 00 : 00'. Below the date is the label 'mm/dd/yy'. The location is set to 'London' with a sun icon and a downward arrow next to it. At the bottom are 'OK' and 'Cancel' buttons. The 'OK' button is highlighted with a yellow border.

- Use the <◀>>▶> keys to select [OK].

#### ! Caution

- The [Date/Time/Zone] setting may be reset when the camera is stored without the battery, when the battery is depleted, or when it is exposed to freezing temperatures for an extended period. If this happens, set them once again.
- After changing [Zone/Time difference], check that the correct date/time are set.



#### Note

- Auto power off time may be extended while the [**⏰**: **Date/Time/Zone**] screen is displayed.

# Language

---

## 1. Select [: Language ].

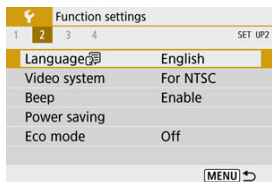

## 2. Set the desired language.



# Video System

---

Set the video system of any television used for display. This setting determines the frame rates available when you record movies.

---

## 1. Select [🔧: Video system].

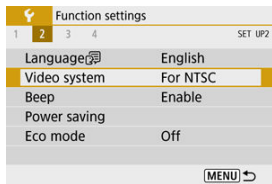

## 2. Select an option.

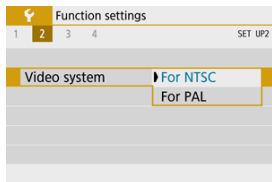

- **For NTSC**  
For areas where the TV system is NTSC (North America, Japan, South Korea, Mexico, etc.).
- **For PAL**  
For areas where the TV system is PAL (Europe, Russia, China, Australia, etc.).

## 1. Select [: Beep].

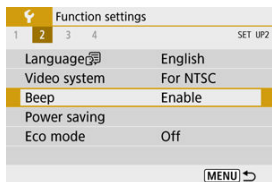

## 2. Select an option.

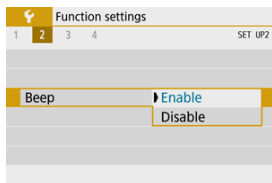

- **Enable**  
The camera beeps after focusing and in other situations.
- **Disable**  
Disables beeping for focus confirmation, self-timer shooting, and other situations.



# Power Saving

You can adjust the timing of when the screen, camera, and viewfinder turn off automatically after the camera is left idle (Display off, Auto power off, and Viewfinder off).

## 1. Select [P: Power saving].

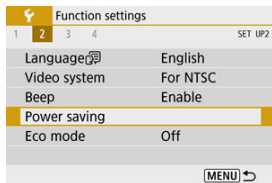

## 2. Select an option.

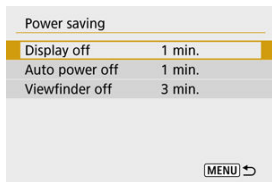

### Note

- Even when [Auto power off] is set to [Disable], the screen will turn off after the time set in [Display off].
- [Display off] and [Auto power off] settings have no effect when [P: Eco mode] is set to [On].

# Eco Mode

---

Enables you to conserve battery power in shooting mode. When the camera is not in use, the screen darkens to reduce battery consumption.

---

## 1. Select [: Eco mode].

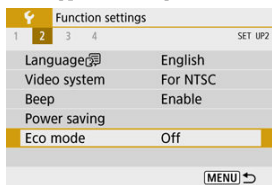

## 2. Select [On].

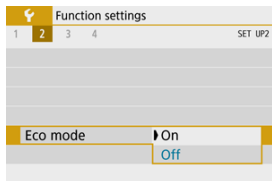

- The screen darkens when the camera is not used for approx. two seconds. Approx. ten seconds after darkening, the screen turns off.
- To activate the screen and prepare for shooting when the screen is off, press the shutter button halfway.

# Display Settings

---

You can specify to use the screen or viewfinder for display, to avoid accidentally activating the viewfinder sensor.

---

1. Select [**F**: Display settings].

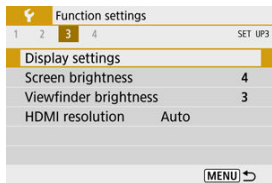

2. Set [Display control] to [Manual].

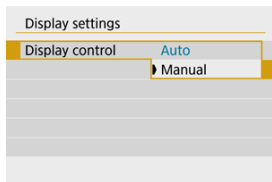

### 3. Select **[Manual display]**.

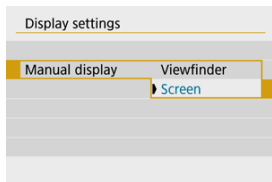

- **Viewfinder**  
Always use the viewfinder for display.
- **Screen**  
Always use the screen for display.

#### **Note**

- With **[Display control]** set to **[Auto]**, the screen is always used for display unless you hold the viewfinder up to your eye, which switches to viewfinder display.

# Screen Brightness

## 1. Select [F: Screen brightness].

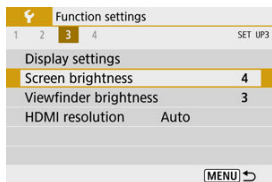

## 2. Make the adjustment.

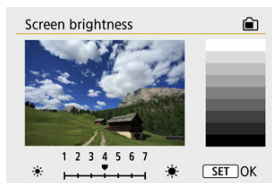

- Referring to the gray image, use the < ◀ ▶ > keys to adjust brightness, then press the < (M) > button.

### Note

- To check the image's exposure, referring to the histogram is recommended (M).

# Viewfinder Brightness

## 1. Select [F: Viewfinder brightness].

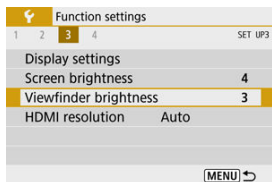

## 2. Make the adjustment.

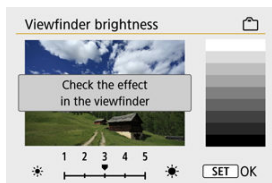

- Holding the viewfinder up to your eye, adjust the setting with the < ◀ ▶ > keys, then press < (M) >.

# HDMI Resolution

---

Set the image output resolution used when the camera is connected to a television or external recording device with an HDMI cable.

---

## 1. Select [: HDMI resolution].

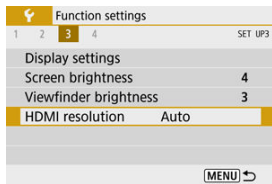

## 2. Select an option.

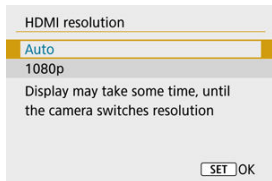

- **Auto**  
The images will automatically be displayed at the optimum resolution matching the connected television.
- **1080p**  
Output at 1080p resolution. Select if you prefer to avoid display or delay issues when the camera switches resolution.

The camera's settings for shooting functions and menu functions can be restored to their defaults.

---

## 1. Select [: Reset camera].

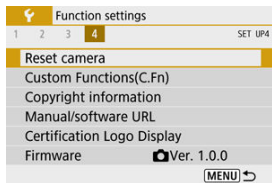

## 2. Select an option.

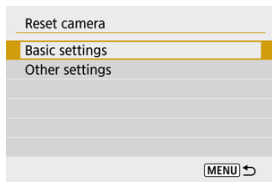

- **Basic settings**  
Restores default settings for camera shooting functions and menu settings.
- **Other settings**  
Settings for individual selected items can be reset.

## 3. Clear the settings.

- Select [**OK**] on the confirmation screen.



- ☑ [Setting Custom Functions](#)
- ☑ [Custom Functions](#)
- ☑ [Custom Function Setting Items](#)

## Setting Custom Functions

### 1. Select [: Custom Functions(C.Fn)].

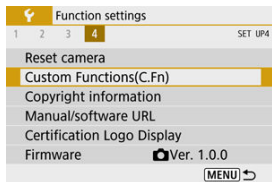

### 2. Select a Custom Function number.

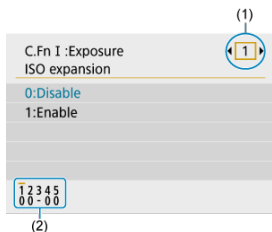

- Use the <◀>>▶> keys to select the number of a Custom Function to configure (1), then press the <Ⓜ> button.
- Current Custom Function settings are indicated below the respective function number at the bottom of the screen (2).

### 3. Change the setting as desired.

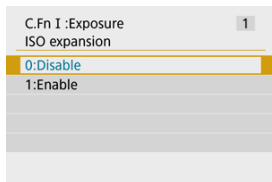

- Select a setting option.
- To set up another Custom Function, repeat steps 2–3.





#### Note

- To clear all Custom Function settings you have configured (except **[Custom Controls]**), access [**⏏**: **Reset camera**] and select [**Custom Functions(C.Fn)**] in [**Other settings**].



## Custom Functions

 Shading indicates that the Custom Function does not apply to this still photo shooting or movie recording. (The settings have no effect.)

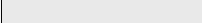
### ● C.Fn I: Exposure

		 Still Photo Shooting	 Movie Recording
(1)	<a href="#">ISO expansion</a>	○	○
(2)	<a href="#">Safety shift</a>	○	

### ● C.Fn II: Others

		 Still Photo Shooting	 Movie Recording
(3)	<a href="#">Custom Controls</a>	Varies by settings	
(4)	<a href="#">Release shutter w/o lens</a>	○	○
(5)	<a href="#">Retract lens on power off</a>	○	○

## Custom Function Setting Items

---

Custom Functions are divided into two groups by function: C.Fn I: Exposure and C.Fn II: Others.

### C.Fn I: Exposure

#### C.Fn 1: ISO expansion

Makes "H" (equivalent to ISO 25600) available as an ISO speed you can set. Note that expanded ISO speeds (H) are not available when [📷: **Highlight tone priority**] is set to [Enable] or [Enhanced].

- 0:Disable
- 1:Enable

#### C.Fn 2: Safety shift

You can shoot with the shutter speed and aperture value automatically adjusted to enable standard exposure if standard exposure would not be available under your specified shutter speed or aperture value in <Tv> or <Av> mode.

- 0:Disable
- 1:Enable

## C.Fn II: Others

### C.Fn 3: Custom Controls

You can assign frequently used functions to camera buttons that are easy for you to use.

#### 1. Select a camera control.

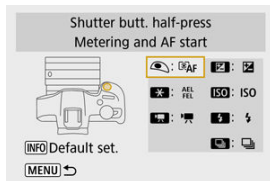

#### 2. Select a function to assign.

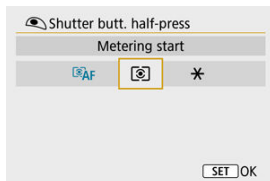

- Press the <  > button to set it.

#### Note

- With the screen in step 1 displayed, you can press the < INFO > button to restore the Custom Control settings to their defaults. [Custom Controls] are not cleared even if you access [Reset camera] and select [Custom Functions(C.Fn)] in [Other settings].

## Functions available for camera controls

### ● AF

●: Default ○: Available for customization

Function							ISO	
	Metering and AF start	●	○					
AF-OFF	AF stop		○					
	Set AF point to center			○	○	○	○	○
ONE SHOT SERVO ↔	One-Shot AF ↔ Servo AF			○	○	○	○	○
AF □	AF method			○	○	○	○	○
	Eye detection			○	○	○	○	○
	Subject to track selection			○	○	○	○	○

### ● MF

●: Default ○: Available for customization

Function							ISO	
MF	Manual focus			○	○	○	○	○
PEAK	Peaking			○	○	○	○	○

### ● Exposure

●: Default ○: Available for customization

Function							ISO	
	Metering start	○						
	AE lock		○					
	AE lock (while button pressed)	○						
AEL FEL	AE lock/FE lock		●					
	Exposure compensation			○	●	○	○	○
ISO	Set ISO speed			○	○	○	●	○
	Metering mode			○	○	○	○	○
	Flash function settings			○	○	○	○	○
	Flash firing			○	○	○	○	●
FEL	FE lock		○					

## ● Movies

●: Default ○: Available for customization

Function							ISO	
	Movie recording			●	○	○	○	○
	Pause Movie Servo AF			○	○	○	○	○

## ● Image

●: Default ○: Available for customization

Function							ISO	
	Image quality			○	○	○	○	○
RAW JPEG	One-touch image quality setting			○	○	○	○	○
RAW JPEG H	One-touch image quality (hold)			○	○	○	○	○
	Still img aspect ratio			○	○	○	○	○
	Auto Lighting Optimizer			○	○	○	○	○
WB	White balance			○	○	○	○	○
	Picture Style			○	○	○	○	○

## ● Operation

●: Default ○: Available for customization

Function							ISO	
	Depth-of-field preview			○	○	○	○	○
	Magnify			○	○	○	○	○
	Image replay			○	○	○	○	○
	Magnify images during playback			○	○	○	○	○
<b>MENU</b>	Menu display			○	○	○	○	○
	Drive mode			○	○	●	○	○
	Select folder			○	○	○	○	○
	Create folder			○	○	○	○	○
	Maximize screen brightness (temp)			○	○	○	○	○
	Display off			○	○	○	○	○
	Switch between VF/screen			○	○	○	○	○
<b>ECO</b>	Eco mode			○	○	○	○	○
	Wi-Fi/Bluetooth connection			○	○	○	○	○
<b>OFF</b>	No function (disabled)		○	○	○	○	○	○



#### C.Fn 4: Release shutter w/o lens

You can specify whether shooting still photos or movies is possible without a lens attached to the camera.

- **0:Disable**
- **1:Enable**

#### C.Fn 5: Retract lens on power off

You can set whether to retract gear-type STM lenses (such as RF35mm F1.8 Macro IS STM) automatically when the camera's power switch is set to < **OFF** >.

- **0:Enable**
- **1:Disable**

#### Caution

- With auto power off, the lens will not retract regardless of the setting.
- Before detaching the lens, make sure that it is retracted.

#### Note

- When [**0:Enable**] is set, this function takes effect regardless of the lens's focus mode switch setting (AF or MF).

☑ [Checking the Copyright Information](#)

☑ [Deleting the Copyright Information](#)

When you set the copyright information, it will be recorded to the image as Exif information.

## 1. Select [: Copyright information].

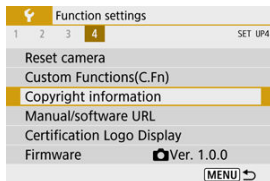



## 2. Select an option.



### 3. Enter text.



- Use the < ▲ >< ▼ >< ◀ >< ▶ > keys to select a character, then press the <  > button to enter it.
- By selecting [&#9650;], you can change the input mode.
- Select [&#9650;] to delete a character.

### 4. Exit the setting.

- Press the < MENU > button, then press [OK].

## Checking the Copyright Information

When you select [**Display copyright info.**] in step 2, you can check the [**Author**] and [**Copyright**] information that you entered.

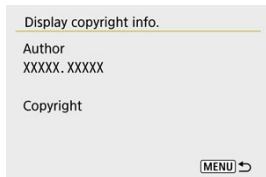

## Deleting the Copyright Information

---

When you select [**Delete copyright information**] in step 2, you can delete the [**Author**] and [**Copyright**] information.

### **Caution**

- If the entry for “Author” or “Copyright” is long, it may not be displayed entirely when you select [**Display copyright info.**].

### **Note**

- You can also set or check the copyright information with EOS Utility (EOS software).

## Other Information

---

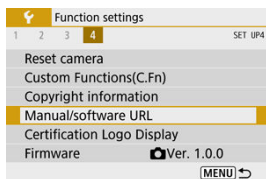

- **Manual/software URL**

To download instruction manuals, select [**F**: **Manual/software URL**] and scan the displayed QR code with a smartphone. You can also use a computer to access the website at the URL displayed and download software.

- **Certification Logo Display**☆



Select [**F**: **Certification Logo Display**] to display some of the logos of the camera's certifications. Other certification logos can be found on the camera body and packaging.

- **Firmware**☆

Select [**F**: **Firmware**] to update the firmware of the camera, lens, or other compatible accessories in use.

On the My Menu tab, you can register menu items and Custom Functions you often adjust.

## Caution

- The [★] tab is not displayed when [: **Menu display**] is set to [**Guided**]. Change [: **Menu display**] to [**Standard**] ().

- [Tab Menus: My Menu](#)
- [Registering My Menu](#)

## Tab Menus: My Menu

---

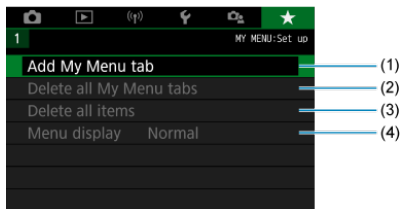

- (1) [Add My Menu tab](#)
- (2) [Delete all My Menu tabs](#)
- (3) [Delete all items](#)
- (4) [Menu display](#)

# Registering My Menu

---

- [Adding My Menu Tabs](#)
- [Registering Menu Items on My Menu Tabs](#)
- [My Menu Tab Settings](#)
- [Deleting All My Menu Tabs/Deleting All Items](#)
- [Menu Display](#)

## Adding My Menu Tabs

---

1. Select [Add My Menu tab].

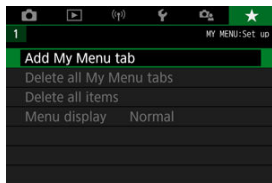

2. Select [OK].

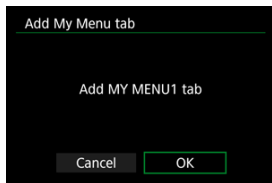

- You can create up to five My Menu tabs by repeating steps 1 and 2.



### 1. Select [MY MENU\*: Configure].

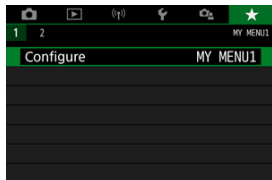

### 2. Select [Select items to register].

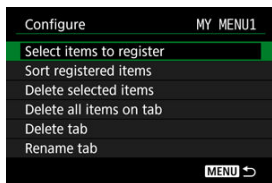

### 3. Register the desired items.

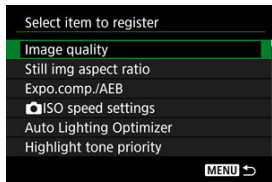



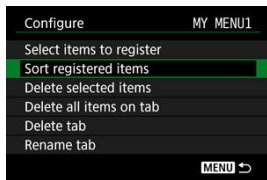

- Select an item, then press the <  > button.
- Select [OK] on the confirmation screen.
- You can register up to six items.
- To return to the screen in step 2, press the < MENU > button.

## My Menu Tab Settings

You can sort and delete items on the menu tab, and rename or delete the menu tab itself.



### Sort registered items

You can change the order of the registered items in My Menu. Select [**Sort registered items**], select an item to rearrange, then press the <  > button. With [] displayed, press the <  ><  > keys to rearrange the item, then press the <  > button.

### Delete selected items/Delete all items on tab

You can delete any of the registered items. [**Delete selected items**] deletes one item at a time, and [**Delete all items on tab**] deletes all the registered items on the tab.

### Delete tab

You can delete the current My Menu tab. Select [**Delete tab**] to delete the [**MY MENU\***] tab.

#### Caution

- Performing [**Delete tab**] also deletes tab names renamed with [**Rename tab**].

## Rename tab

You can rename the My Menu tab from **[MY MENU\*]**.

1. Select **[Rename tab]**.

2. Enter text.



- To delete any unneeded characters, select [**X**].
- Use the <▲><<▼>><◀>><▶> keys to select a character, then press the <⏏> button to enter it.
- By selecting [**🔊**], you can change the input mode.

3. Confirm input.

- Press the <MENU> button, then select **[OK]**.

## Deleting All My Menu Tabs/Deleting All Items

You can delete all the created My Menu tabs or My Menu items registered on them.

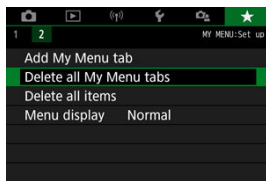

### Delete all My Menu tabs

You can delete all My Menu tabs you created. When you select **[Delete all My Menu tabs]**, all the tabs from **[MY MENU1]** to **[MY MENU5]** will be deleted and the **[★]** tab will revert to its default.

#### ! Caution

- Performing **[Delete all My Menu tabs]** also deletes tab names renamed with **[Rename tab]**.

### Delete all items

You can delete all the items registered under the **[MY MENU1]** to **[MY MENU5]** tabs. The tabs themselves will remain. When **[Delete all items]** is selected, all the items registered on all the created tabs will be deleted.

## Menu Display

You can select **[Menu display]** to set the menu screen that is to appear first when you press the **<MENU>** button.

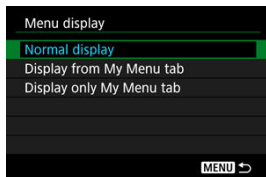

- **Normal display**  
Displays the last displayed menu screen.
- **Display from My Menu tab**  
Displays with the **[★]** tab selected.
- **Display only My Menu tab**  
Restricts display to the **[★]** tab (**[📷]**/**[▶]**/**[⏮]**/**[⏪]**/**[⏩]**/**[📷]** tabs are not displayed).

## Reference

---

This chapter provides reference information on camera features.

- [Importing Images to a Computer](#)
- [Troubleshooting Guide](#)
- [Error Codes](#)
- [ISO Speed in Movie Recording](#)
- [Information Display](#)
- [Specifications](#)

## Importing Images to a Computer

---

[Connecting to a Computer with an Interface Cable](#)

[Using a Card Reader](#)

[Connecting to a Computer via Wi-Fi](#)

You can use EOS software to import images from the camera to a computer.

---

### Connecting to a Computer with an Interface Cable

---

1. Install EOS Utility ()
2. Connect the camera to the computer.

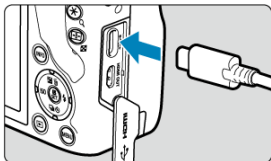

- Use an interface cable.
  - Connect the other end to a USB port on the computer.
3. Use EOS Utility to import the images.
    - Refer to the EOS Utility Instruction Manual.

#### Caution

- With a Wi-Fi connection established, the camera cannot communicate with the computer even if they are connected with an interface cable.

## Using a Card Reader

---

You can use a card reader to import images to a computer.

1. **Install Digital Photo Professional** .
2. **Insert the card into the card reader.**
3. **Use Digital Photo Professional to import the images.**

- Refer to the Digital Photo Professional Instruction Manual.



### Note

- When downloading images from the camera to a computer with a card reader without using EOS software, copy the DCIM folder on the card to the computer.









## Connecting to a Computer via Wi-Fi

---

You can connect the camera to the computer via Wi-Fi and import images to the computer (☑).

# Troubleshooting Guide

---

-  [Power-related problems](#)
-  [Shooting-related problems](#)
-  [Problems with wireless features](#)
-  [Operation problems](#)
-  [Display problems](#)
-  [Playback problems](#)
-  [Computer connection problems](#)

If a problem occurs with the camera, first refer to this Troubleshooting Guide. If this Troubleshooting Guide does not resolve the problem, take the camera to the nearest Canon Service Center.

## Power-related problems

### Batteries cannot be charged with the battery charger.

---

- Do not use any battery packs other than a genuine Canon Battery Pack LP-E17.
- In case of charging or charger issues, see [Charging the Battery](#).



### The battery charger lamp is blinking.

---

- Orange blinking of the lamp indicates that a protection circuit has prevented charging because (1) there is a problem with the battery charger or battery, or (2) communication with a non-Canon battery has failed. In the case of (1), unplug the charger, reinsert the battery, and wait a few minutes before plugging the charger in again. If the problem persists, take the camera to the nearest Canon Service Center.

### The camera is not activated even when the power switch is set to <ON>.

---

- Make sure the battery is inserted properly in the camera .
- Make sure the card/battery compartment cover is closed .
- Charge the battery .

## The access lamp still lights or blinks even when the power switch is set to <OFF>.

---

- If the power is turned off while an image is being recorded to the card, the access lamp will remain on or continue to blink for a few seconds. When the image recording is complete, the power will turn off automatically.

## [Battery communication error. Does this battery/do these batteries display the Canon logo?] is displayed.

---

- Do not use any battery packs other than a genuine Canon Battery Pack LP-E17.
- Remove and install the battery again (🔧).
- If the electrical contacts are dirty, use a soft cloth to clean them.

## The battery becomes exhausted quickly.

---

- Use a fully charged battery (🔋).
- The battery performance may have degraded. If the battery performance is poor, replace the battery with a new one.
- The number of available shots will decrease with any of the following operations:
  - Pressing the shutter button halfway for a prolonged period
  - Activating the AF frequently without taking a picture
  - Using the lens's Image Stabilizer
  - Using the wireless communication functions

## The camera turns off by itself.

---

- Auto power off is in effect. To deactivate auto power off, set [Auto power off] in [🔧: Power saving] to [Disable] (🔧).
- Even if [Auto power off] is set to [Disable], the screen and viewfinder will still turn off after the camera is left idle for the time set in [Display off] or [Viewfinder off] (although the camera itself remains on).
- Set [🔧: Eco mode] to [Off].

## Shooting-related problems

### The lens cannot be attached.

---

- To attach EF or EF-S lenses, you will need a mount adapter. The camera cannot be used with EF-M lenses (🔗).

### No images can be shot or recorded.

---

- Make sure the card is properly inserted (🔗).
- Slide the card's write-protect switch to the Write/Erase setting (🔗).
- If the card is full, replace the card or delete unnecessary images to make space (🔗, 🔗).
- Shooting is not possible if the AF point turns orange when you attempt to focus. Press the shutter button halfway again to refocus automatically, or focus manually (🔗, 🔗).

### The card cannot be used.

---

- If a card error message is displayed, see [Inserting/Removing the Battery and Card](#) and [Error Codes](#).

### An error message is displayed when the card is inserted in another camera.

---

- Since SDXC cards are formatted in exFAT, if you format a card with this camera and then insert it into another camera, an error may be displayed and it may not be possible to use the card.

### The image is out of focus or blurred.

---

- Set the focus mode to **[AF]** (🔗).
- Press the shutter button gently to prevent camera shake (🔗).
- With a lens equipped with an Image Stabilizer, set the Image Stabilizer switch to **< ON >**.
- In low light, the shutter speed may become slow. Use a faster shutter speed (🔗), set a higher ISO speed (🔗), use flash (🔗), or use a tripod.
- See [Minimizing blurred photos](#).

### I cannot lock the focus and recompose the shot.

---

- Set the AF operation to One-Shot AF (🔗). Shooting with the focus locked is not possible with Servo AF (🔗).

## The continuous shooting speed is slow.

---

- Continuous shooting may be slower depending on the battery level, ambient temperature, flicker reduction, shutter speed, aperture value, subject conditions, brightness, AF operation, type of lens, use of flash, shooting settings, and other conditions. For details, see [Drive Mode](#) or [Maximum burst \(approx. shots\)](#).

## The maximum burst during continuous shooting is lower.

---

- Shooting intricate subjects such as fields of grass may result in larger file sizes, and the actual maximum burst may be lower than the guidelines in [Maximum burst \(approx. shots\)](#).

## Even after I change the card, the maximum burst displayed for continuous shooting does not change.

---

- Estimated maximum burst indicated in the viewfinder does not change when you switch cards, even if you switch to a high-speed card. Maximum burst listed in [Maximum burst \(approx. shots\)](#) is based on the standard Canon test card, and the actual maximum burst is higher for cards with faster writing speeds. For this reason, estimated maximum burst may differ from actual maximum burst.

## ISO 100 cannot be set for still photo shooting.

---

- The minimum speed in the ISO speed range is ISO 200 when [: **Highlight tone priority**] is set to **[Enable]** or **[Enhanced]**.



## Expanded ISO speeds cannot be selected for still photo shooting.

---

- Check the **[ISO speed]** setting in [: : **ISO speed settings**].
- Expanded ISO speeds (H) are not available when [: **Highlight tone priority**] is set to **[Enable]** or **[Enhanced]**, even with **[ISO expansion]** set to **[1:On]** in [: **Custom Functions(C.Fn)**].

## Even if I set a decreased exposure compensation, the image comes out bright.

---

- Set [: **Auto Lighting Optimizer**] to **[Disable]** (). When **[Low]**, **[Standard]**, or **[High]** is set, even if you set a decreased exposure compensation or flash exposure compensation, the image may come out bright.

## I cannot set the exposure compensation when both manual exposure and ISO Auto are set.

---

- See [M: Manual Exposure](#) to set the exposure compensation.

## Not all the lens aberration correction options are displayed.

---

- Although [**Chromatic aberr corr**] and [**Diffraction correction**] are not displayed when [**Digital Lens Optimizer**] is set to [**Enable**], both functions are applied in shooting, as when set to [**Enable**].
- During movie recording, [**Digital Lens Optimizer**] or [**Diffraction correction**] are not displayed.

## Using flash in <Av> or <P> mode lowers the shutter speed.

---

- Set [**Slow synchro**] in [: **Flash control**] to [**1/250-1/60sec. auto**] or [**1/250 sec. (fixed)**] ().

## The built-in flash does not fire.

---

- Shooting with the flash may be temporarily disabled to protect the flash head if the built-in flash is used repeatedly over a short period.



## The external Speedlite does not fire.

---

- Make sure any external flash units are securely attached to the camera.

## The Speedlite always fires at full output.

---

- Flash units other than EL/EX series Speedlites used in autoflash mode always fire at full output ().
- The flash always fires at full output when [**Flash metering mode**] in external flash Custom Function settings is set to [**1:TTL**] (autoflash) ().

## External flash exposure compensation cannot be set.

---

- If flash exposure compensation is set with the external Speedlite, compensation amount cannot be set with the camera. When the Speedlite's flash exposure compensation is canceled (set to 0), flash exposure compensation can be set with the camera.

## High-speed sync is not available in <Av> mode.

---

- Set [Slow synchro] in [Flash control] to an option other than [1/250 sec. (fixed)] (🔗).

## Remote control shooting is not possible.

---

- When taking still photos, set the drive mode to <📷> or <📷2> (🔗). In movie recording, set [Remote control] to [Enable] (🔗).
- Check the position of the remote control's release timing switch.
- If you are using Wireless Remote Control BR-E1, see [Wireless Remote Control BR-E1](#).
- To use a remote control for time-lapse movie recording, see [Time-Lapse Movies](#).

## A white [🔥] or red [🔥] icon is displayed in still photo shooting.

---

- It indicates that the camera's internal temperature is high. Image quality of still photos may be worse when a white [🔥] icon is displayed. Display of a red [🔥] icon indicates that shooting will soon stop automatically (🔗).

## A red [🔥] icon is displayed during movie recording.

---

- It indicates that the camera's internal temperature is high. If the red [🔥] icon is displayed, it indicates that the movie recording will soon stop automatically (🔗).

## A red [🔥] icon is displayed.

---

- If the camera temporarily overheats during extended 4K recording, [🔥] is displayed and recording stops. At this time, movie recording will be unavailable, even if you press the movie shooting button.

Following the instructions displayed, either set the movie recording size to an option other than [4K 23.98P] or [4K 25.00P] or turn off the camera to let it cool down before you resume recording.

## Movie recording stops by itself.

---

- If the card's writing speed is slow, movie recording may stop automatically. For details on cards that can record movies, see [Card performance requirements \(movie recording\) \[write/read speed\]](#). To find out the card's writing speed, refer to the card manufacturer's website, etc.
- Perform low-level formatting to initialize the card if the card's writing or reading speed seems slow (🔗).
- After you start recording a movie, recording will stop automatically after 29 min. 59 sec.

## The ISO speed cannot be set for movie recording.

---

- ISO speed is set automatically in [M] recording mode. In [M] mode, you can manually set the ISO speed (🔗).
- The minimum speed in the ISO speed range is ISO 200 when [📷: Highlight tone priority] is set to [Enable] or [Enhanced].

## The manually set ISO speed changes when switching to movie recording.

---

- For still photo shooting, ISO speed is set according to [ISO speed] in [📷: 📷ISO speed settings] (🔗), and for movie recording, according to [ISO speed] in [📷: 🎥ISO speed settings] (🔗).

## Expanded ISO speeds cannot be selected for movie recording.

---

- Check the [ISO speed] setting in [📷: 🎥ISO speed settings].
- Expanded ISO speeds are not available when [📷: Highlight tone priority] is set to [Enable] or [Enhanced].
- H (expanded ISO speed) is not available (not displayed) in 4K movie recording.

## The exposure changes during movie recording.

---

- If you change the shutter speed or aperture value during movie recording, the changes in the exposure may be recorded.
- Recording a few test movies is recommended if you intend to perform zooming during movie recording. Zooming as you record movies may cause exposure changes or lens sounds to be recorded, or loss of focus.

## The image flickers or horizontal stripes appear during movie recording.

---

- Flickering, horizontal stripes (noise), or irregular exposures can be caused by fluorescent lighting, LED lighting, or other light sources during movie recording. Also, changes in the exposure (brightness) or color tone may be recorded. In [M] mode, using a slower shutter speed may reduce the problem. The problem may be more noticeable in time-lapse movie recording.



## **The subject looks distorted during movie recording.**

---

- If you move the camera to the left or right (panning) or shoot a moving subject, the image may look distorted.

## **I cannot take still photos during movie recording.**

---

- Still photos cannot be taken during movie recording. To shoot still photos, stop recording the movie, then select a shooting mode for still photos.

### **Cannot pair with a smartphone.**

---

- Use a smartphone compliant with Bluetooth Specification Version 4.1 or later.
- Turn on Bluetooth from the smartphone settings screen.
- Pairing with the camera is not possible from the smartphone's Bluetooth settings screen. Install the dedicated app Camera Connect (free of charge) on the smartphone (📲).
- Pairing with a previously paired smartphone is not possible if pairing information registered for another camera remains on the smartphone. In this case, remove the camera's registration retained in the Bluetooth settings on the smartphone and try pairing again (📲).

### **Wi-Fi functions cannot be set.**

---

- If the camera is connected to a computer or another device with an interface cable, Wi-Fi functions cannot be set. Disconnect the interface cable before setting any functions (📲).

### **A device connected with an interface cable cannot be used.**

---

- Other devices, such as computers, cannot be used with the camera by connecting them with an interface cable while the camera is connected to devices via Wi-Fi. Terminate the Wi-Fi connection before connecting the interface cable.

### **Operations such as shooting and playback are not possible.**

---

- With a Wi-Fi connection established, operations such as shooting and playback may not be possible. Terminate the Wi-Fi connection, then perform the operation.

### **Cannot reconnect to a smartphone.**

---

- Even with a combination of the same camera and smartphone, if you have changed the settings or selected a different setting, reconnection may not be established even after selecting the same SSID. In this case, delete the camera connection settings from the Wi-Fi settings on the smartphone and set up a connection again.
- A connection may not be established if Camera Connect is running when you reconfigure connection settings. In this case, quit Camera Connect for a moment and then restart it.



### Settings change when I switch from still photo shooting to movie recording or vice versa.

---

- Separate settings are retained for use when shooting still photos and recording movies.

### A camera button or dial does not work as expected.

---

- In movie recording, check the [: **Shutter btn function for movies**] setting ([?](#)).
- Check [**Custom Controls**] setting details in [: **Custom Functions(C.Fn)**] ([?](#)).

## Display problems

### The menu screen shows fewer tabs and items.

---

- Certain tabs and items are not shown in Basic Zone modes or movie recording.

### The display starts with [★] My Menu, or the [★] tab alone is displayed.

---

- [Menu display] on the [★] tab is set to [Display from My Menu tab] or [Display only My Menu tab]. Set [Normal display] (🔗).

### The file name's first character is an underscore (“\_”).

---

- Set [📷: Color space] to [sRGB]. If [Adobe RGB] is set, the first character will be an underscore (🔗).

### The file name starts with “MVI\_”.

---

- It is a movie file (🔗).

### The file numbering does not start from 0001.

---

- If the card already contains recorded images, the image number may not start from 0001 (🔗).

### The shooting date and time displayed are incorrect.

---

- Make sure the correct date and time are set (🔗).
- Check the time zone and daylight saving time (🔗).

### The date and time are not in the image.

---

- The shooting date and time do not appear in the image. The date and time are recorded in the image data as shooting information. When you print photos, this information can be used to include the date and time (🔗).

### [###] is displayed.

---

- If the number of images recorded on the card exceeds the number the camera can display, [###] will be displayed.

## **The screen does not display a clear image.**

---

- If the screen is dirty, use a soft cloth to clean it.
- The screen display may seem slightly slow in low temperatures or may look black in high temperatures, but it will return to normal at room temperature.

## Playback problems

### A red box is displayed on the image.

---

- [▶]: AF point disp.] is set to [Enable] (🔒).

### During image playback, the AF points are not displayed.

---

- AF points are not displayed when the following types of images are played back:
  - Images taken in < SCN : 📷 📷 > mode.
  - Images taken in < 📷 : 📷HDR 📷HDR 📷HDR 📷HDR > mode.
  - Images taken with Multi Shot Noise Reduction applied.
  - Cropped images.

### The image cannot be erased.

---

- If the image is protected, it cannot be erased (🔒).

### Still photos and movies cannot be played back.

---

- The camera may not be able to play back images taken with another camera.
- Movies edited with a computer cannot be played back with the camera.

### Only few images can be played back.

---

- The images have been filtered for playback with [▶]: Set image search conditions] (🔒). Clear the image search conditions.

### Mechanical sounds or sounds of camera operations can be heard during movie playback.

---

- The camera's built-in microphone may also record mechanical sounds of the lens or sounds of camera/lens operations if AF operations are performed or the camera or lens is operated during movie recording. In this case, using an external microphone may reduce these sounds. If the sounds are still distracting with an external microphone, it may be more effective to remove the external microphone from the camera and position it away from the camera and lens.

## **The movie appears to freeze momentarily.**

---

- Significant change in the exposure level during autoexposure movie recording may cause recording to stop momentarily until the brightness stabilizes. In this case, record in [M] mode (🔗).

## **No picture appears on the television.**

---

- Make sure [🔗: Video system] is set to [For NTSC] or [For PAL] correctly for the video system of your television.
- Make sure the HDMI cable's plug is inserted all the way in (🔗).

## **There are multiple movie files for a single movie recording.**

---

- If the movie file size reaches 4 GB, another movie file will be created automatically (🔗). However, if you use an SDXC card formatted with the camera, you can record a movie in a single file even if it exceeds 4 GB.

## **My card reader does not recognize the card.**

---

- Depending on the card reader used and the computer's operating system, SDXC cards may not be correctly recognized. In this case, connect the camera to the computer with the interface cable, then import the images to the computer using EOS Utility (EOS software, 🔗).

## **Images cannot be resized or cropped.**

---

- This camera cannot resize JPEG S2 images, RAW images, or frame-grab images from 4K movies saved as still photos (🔗).
- This camera cannot crop RAW images or frame-grab images from 4K movies saved as still photos (🔗).

### I cannot import images to a computer.

---

- Install EOS Utility (EOS software) on the computer (🔗).
- Make sure the main EOS Utility window is displayed.
- If the camera is already connected via Wi-Fi, it cannot communicate with any computer connected with an interface cable.
- Check the version of the application.

### Communication between the connected camera and computer does not work.

---

- When using EOS Utility (EOS software), set [📷: Time-lapse movie] to [Disable] (🔗).



## Error Codes

---

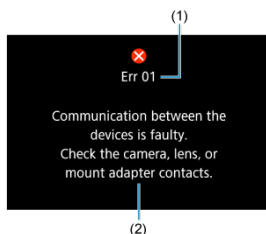

(1) Error number

(2) Cause and countermeasures

If there is a problem with the camera, an error message will appear. Follow the on-screen instructions.

If the problem persists, write down the error code (Err xx) and request service.

## ISO Speed in Movie Recording

---

### In [P] mode, when set to ISO Auto

- ISO speed is automatically set in a range of ISO 100–12800 for Full HD/HD movies and ISO 100–6400 for 4K movies.
- The maximum value in the automatic setting range is expanded to H (equivalent to ISO 25600) in Full HD/HD movie recording when [ISO expansion] in [P]: Custom Functions(C.Fn)] is set to [1:Enable] and then [Max for Auto] in [P]: ISO speed settings] is set to [H(25600)]. Note that in 4K movie recording, maximum ISO speed expansion is not available, even with [ISO expansion] set to [1:Enable].
- With [P]: Highlight tone priority] set to [Enable], the minimum value in the automatic setting range is ISO 200. Maximum ISO speed is not expanded, even with [Max for Auto] set to [H (25600)].

### In [M] mode with ISO speed set manually

- ISO speed can be set manually in a range of ISO 100–12800 for Full HD/HD movies and ISO 100–6400 for 4K movies.
- The maximum value in the manual setting range is expanded to H (equivalent to ISO 25600) in Full HD/HD movie recording when [ISO expansion] in [P]: Custom Functions(C.Fn)] is set to [1:Enable]. Note that in 4K movie recording, maximum ISO speed expansion is not available ([H] is not displayed), even with [ISO expansion] set to [1:Enable].
- With [P]: Highlight tone priority] set to [Enable], the minimum value in the manual setting range is ISO 200. Maximum ISO speed is not expanded, even with [ISO expansion] set to [1:Enable].

## Information Display

---

- [Quick Control Screen](#)
- [Still Photo Shooting Screen](#)
- [Movie Recording Screen](#)
- [Scene Icons](#)
- [Playback Screen](#)

## Quick Control Screen

In Creative Zone modes (other than the shooting functions screen)

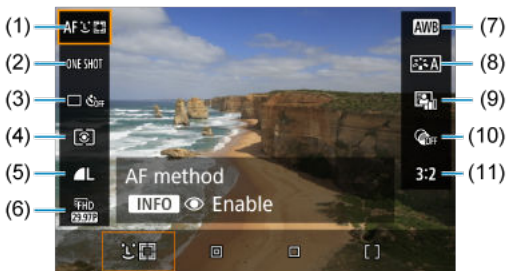

- |      |                          |
|------|--------------------------|
| (1)  | AF method                |
| (2)  | AF operation             |
| (3)  | Drive mode               |
| (4)  | Metering mode            |
| (5)  | Image quality            |
| (6)  | Movie recording size     |
| (7)  | White balance            |
| (8)  | Picture Style            |
| (9)  | Auto Lighting Optimizer  |
| (10) | Creative filters         |
| (11) | Still image aspect ratio |

## Shooting functions screen in Creative Zone modes

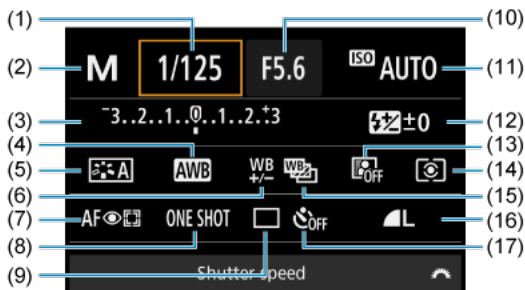

- |      |                                   |
|------|-----------------------------------|
| (1)  | Shutter speed                     |
| (2)  | Shooting mode*                    |
| (3)  | Exposure compensation/AEB setting |
| (4)  | White balance                     |
| (5)  | Picture Style                     |
| (6)  | White balance correction          |
| (7)  | AF method                         |
| (8)  | AF operation                      |
| (9)  | Drive mode                        |
| (10) | Aperture value                    |
| (11) | ISO speed                         |
| (12) | Flash exposure compensation       |
| (13) | Auto Lighting Optimizer           |
| (14) | Metering mode                     |
| (15) | White balance bracketing          |
| (16) | Image quality                     |
| (17) | Self-timer                        |

\* These functions cannot be set with Quick Control.

## During movie recording



- 
- (1) Shooting mode
  - (2) AF method
  - (3) Movie self-timer
  - (4) Movie recording size
  - (5) Digital zoom
  - (6) Movie digital IS
  - (7) White balance
  - (8) Picture Style
  - (9) Auto Lighting Optimizer
  - (10) Miniature effect movie
-

## Still Photo Shooting Screen

Each time you press the <INFO> button, the information display will change.

- The display will show only the settings currently applied.

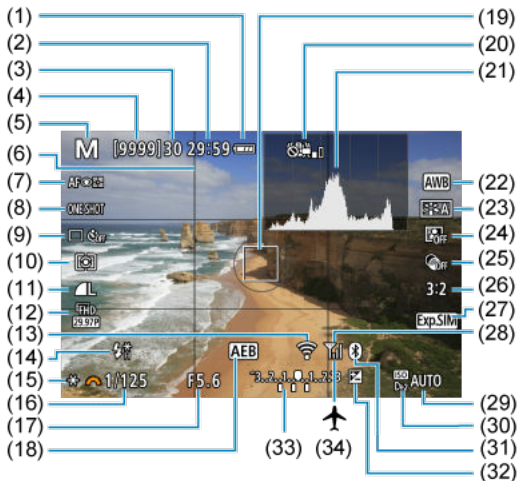

- (1) Battery level
- (2) Movie recording time available
- (3) Maximum burst
- (4) Number of available shots/Sec. until self-timer shoots
- (5) Shooting mode/Scene icon
- (6) Grid
- (7) AF method
- (8) AF operation
- (9) Drive mode
- (10) Metering mode
- (11) Image quality
- (12) Movie recording size
- (13) Wi-Fi function
- (14) Warning to use flash (blinking)/Flash ready (on)/FE lock/High-speed sync
- (15) AE lock
- (16) Shutter speed
- (17) Aperture value
- (18) AEB
- (19) AF point (1-point AF)
- (20) Warning: Deactivating Movie digital IS recommended
- (21) Histogram (Brightness/RGB)
- (22) White balance/White balance correction
- (23) Picture Style
- (24) Auto Lighting Optimizer
- (25) Creative filters
- (26) Still image aspect ratio
- (27) Exposure simulation
- (28) Wi-Fi signal strength
- (29) ISO speed
- (30) Highlight tone priority
- (31) Bluetooth function
- (32) Exposure compensation
- (33) Exposure level indicator
- (34) Airplane mode

 **Note**

- You can specify the information displayed in response to pressing the < INFO > button (📷).
- Other icons may be displayed temporarily after setting adjustments.



## Movie Recording Screen

Each time you press the <INFO> button, the information display will change.

- The display will show only the settings currently applied.

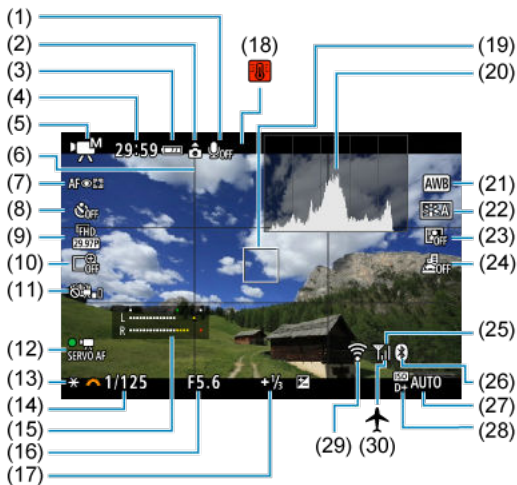

- |      |   |
|------|---|
| (1)  | Sound recording off indicator                         |
| (2)  | Movie orientation information                         |
| (3)  | Battery level   |
| (4)  | Movie recording time available/Elapsed recording time |
| (5)  | Movie recording mode                                  |
| (6)  | Grid  |
| (7)  | AF method   |
| (8)  | Movie self-timer                                      |
| (9)  | Movie recording size                                  |
| (10) | Digital zoom  |
| (11) | Movie digital IS                                      |
| (12) | Movie Servo AF  |
| (13) | AE lock   |
| (14) | Shutter speed   |
| (15) | Audio recording level indicator (manual/line input)   |
| (16) | Aperture value  |
| (17) | Exposure compensation                                 |
| (18) | Temperature warning                                   |
| (19) | AF point (1-point AF)                                 |
| (20) | Histogram   |
| (21) | White balance/White balance correction                |
| (22) | Picture Style   |
| (23) | Auto Lighting Optimizer                               |
| (24) | Miniature effect movie                                |
| (25) | Wi-Fi signal strength                                 |
| (26) | Bluetooth function                                    |
| (27) | ISO speed   |
| (28) | Highlight tone priority                               |
| (29) | Wi-Fi function  |
| (30) | Airplane mode   |

 **Caution**





























- You can specify the information displayed in response to pressing the <INFO> button (🔍).
- The grid and histogram cannot be displayed during movie recording (and if they are currently displayed, recording a movie will clear the display).
- When movie recording starts, the movie recording remaining time will change to the elapsed time.

**Note**

- Other icons may be displayed temporarily after setting adjustments.

## Scene Icons

In <  > shooting mode, the camera detects the type of scene and sets all settings accordingly. The detected scene type is indicated in the upper left of the screen.

Subject Background	People		Subjects Other Than People			Background Color
		In Motion	Nature/ Outdoor Scene	In Motion	At Close Range	
Bright						Gray
Backlit						
Blue Sky Included						Light blue
Backlit						
Sunset	*1				*1	Orange
Spotlight						Dark blue
Dark						
With Tripod		*1		*1		

\* 1: Icons of scenes selected from those that can be detected are displayed.

### Caution

- Icons displayed may not match the actual scene, depending on the scene, shooting conditions, lens used, and other factors.

## Playback Screen

### Basic information display for still photos



- |      |  |
|------|--|
| (1)  | Wi-Fi function                                     |
| (2)  | Wi-Fi signal strength                              |
| (3)  | Battery level                                      |
| (4)  | Current image no./Total images/No. of images found |
| (5)  | Airplane mode                                      |
| (6)  | Shutter speed                                      |
| (7)  | Aperture value                                     |
| (8)  | Exposure compensation amount                       |
| (9)  | Bluetooth function                                 |
| (10) | Rating   |
| (11) | Image protection                                   |
| (12) | Folder no.-File no.                                |
| (13) | Image quality/Edited image/Cropping                |
| (14) | ISO speed  |
| (15) | Highlight tone priority                            |

 **Caution**

- You can specify the information displayed in response to pressing the < INFO > button ()
- If the image was taken by another camera, certain shooting information may not be displayed.
- It may not be possible to play back images taken with this camera on other cameras.

## Detailed information display for still photos

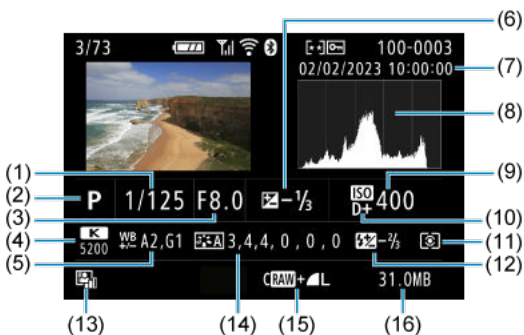

- |      |  |
|------|--|
| (1)  | Shutter speed  |
| (2)  | Shooting mode  |
| (3)  | Aperture value                                       |
| (4)  | White balance  |
| (5)  | White balance correction amount                      |
| (6)  | Exposure compensation amount                         |
| (7)  | Shooting date and time                               |
| (8)  | Histogram (Brightness/RGB)                           |
| (9)  | ISO speed  |
| (10) | Highlight tone priority                              |
| (11) | Metering mode  |
| (12) | Flash photography/Flash exposure compensation amount |
| (13) | Auto Lighting Optimizer                              |
| (14) | Picture Style/Settings                               |
| (15) | Image quality/Edited image/Cropping                  |
| (16) | File size  |

\* When you shoot in RAW+JPEG image quality, the RAW image file size will be displayed.

\* Lines indicating the image area are displayed for images taken with the aspect ratio set (Ⓔ) and with RAW or RAW+JPEG set for image quality.

\* During flash photography without flash exposure compensation, (Ⓕ) will be displayed.

\* (Ⓖ) indicates Creative filter shots, or images saved after resizing, cropping, or frame-grabbing.

## Detailed information display for movies



- (1) Movie playback
- (2) Movie recording mode/Time-lapse movie
- (3) Movie orientation information
- (4) Image size
- (5) Frame rate
- (6) Movie digital IS
- (7) Recording time
- (8) Movie recording format
- (9) Movie compression method

\* For simplicity, explanations are omitted for items that are also included in basic/detailed information display for still photos, which are not shown here.

### Note

- During movie playback, “\*,\*” is displayed for the [Fineness] and [Threshold] parameters of [Sharpness] in [Picture Style].



# Specifications

---

## Type

**Type:** Digital single-lens non-reflex AF/AE camera

**Lens mount:** Canon RF mount

**Compatible lenses:** Canon RF lens group (including RF-S lenses)

\* Canon EF or EF-S lenses (excluding EF-M lenses) also compatible, using mount adapter EF-EOS R

**Lens focal length:** Approx. 1.6 times the focal length indicated on the lens

## Image sensor

**Type:** APS-C CMOS sensor

Effective pixels*1*2	Max. approx. 24.1 megapixels
Total pixels*1	Approx. 25.8 megapixels
Screen size	Approx. 22.3×14.9 mm
Dual Pixel CMOS AF	Supported

\* 1: Rounded to the nearest 100,000.

\* 2: Using RF or EF lenses.

The effective pixel count may be lower with certain lenses and image processing.

## Recording system

**Image recording format:** Compliant with Design rule for Camera File system 2.0 and Exif 2.31\*1

\* 1: Supports time offset information

## Image type and extension

Image type		Extension
Still photos	JPEG	.JPG
	RAW	.CR3
	C-RAW	
Movies	ALL-I*1, IPB (Standard)	.MP4

\* 1: Time-lapse movies only

\* Still photos: HEIF not supported

\* Movies: IPB (Light) not supported

## Recording media

### Recording media

SD/SDHC/SDXC memory cards

UHS-I	Supported
UHS Speed Class	Supported
SD Speed Class	Supported

**Card slot:** Equipped with a single slot

\* Supports UHS-I

## Still photo recording

### Still photo pixel count

Image quality		Recorded pixels			
		Aspect ratio			
		3:2	4:3	16:9	1:1
JPEG	<b>L</b>	24.0 megapixels (6000×4000)	Approx. 21.3 megapixels* <sup>1</sup> (5328×4000)	Approx. 20.2 megapixels* <sup>1</sup> (6000×3368)	16.0 megapixels (4000×4000)
	<b>M</b>	Approx. 10.6 megapixels (3984×2656)	Approx. 9.5 megapixels (3552×2664)	Approx. 8.9 megapixels* <sup>1</sup> (3984×2240)	Approx. 7.1 megapixels (2656×2656)
	<b>S1</b>	Approx. 5.9 megapixels (2976×1984)	Approx. 5.3 megapixels (2656×1992)	Approx. 5.0 megapixels* <sup>1</sup> (2976×1680)	Approx. 3.9 megapixels (1984×1984)
	<b>S2</b>	Approx. 3.8 megapixels (2400×1600)	Approx. 3.4 megapixels* <sup>1</sup> (2112×1600)	Approx. 3.2 megapixels* <sup>1</sup> (2400×1344)	Approx. 2.6 megapixels (1600×1600)
RAW	<b>RAW / CRAW</b>	24.0 megapixels (6000×4000)			

\* Values for recorded pixels are rounded off to the nearest 100,000th.









\* RAW/C-RAW images are generated at 3:2 and tagged to indicate the specified aspect ratio.

\* JPEG images are generated at the specified aspect ratio.

\* These aspect ratios (M/S1/S2) and pixel counts also apply to resizing.

\* 1: Aspect ratios are slightly different for these image sizes.

## File size/number of shots available

Image quality		File size [Approx. MB]	Available shots [Approx.]* <sup>1</sup>
JPEG		8.4	3600
		4.5	6610
		4.6	6480
		2.6	11400
		3.1	9690
		1.8	16010
		1.8	16340
RAW		27.2	1120
		15.8	1930
RAW+JPEG		27.2 + 8.4	850
		15.8 + 8.4	1250









\* 1: Number of shots using a 32 GB card that conforms to Canon testing standards.

\* File sizes are determined based on Canon testing standards.

\* File size varies by shooting conditions (such as aspect ratio, subject, ISO speed, Picture Style, and Custom Functions).

## Maximum burst (approx. shots)

Number of shots available when set to [📷], without slower continuous shooting speed

Image quality		Electronic 1st-curtain (approx. 6.5 shots/sec.)* <sup>1</sup>
		Standard card* <sup>2</sup>
JPEG		100
		97
		97
		97
RAW		6
		17
RAW+JPEG		6
		13

\* 1: For details on shooting conditions, see "[Drive mode and continuous shooting speed](#)".

\* 2: Number of shots using a UHS-I compliant 32 GB card that conforms to Canon testing standards.

\* Maximum burst as measured under conditions conforming to Canon testing standards (continuous shooting in One-Shot AF mode, ISO 100, and Standard Picture Style).

\* Maximum burst varies depending on shooting conditions (including aspect ratio, subject, memory card brand, ISO speed, Picture Style, and Custom Function, etc.).

\* Setting Auto Lighting Optimizer to [High] reduces maximum burst.

## Movie recording

Movie recording format: MP4

### Estimated recording time and movie bit rate/file size

Movie recording size			Total recording time (approx.)			Movie bit rate (approx. Mbps)	File size (approx. MB/min.)	
Movie recording	Frame rate (fps)		Compression method	32 GB	128 GB			512 GB
	NTSC	PAL						
4K UHD	23.98	25.00	IPB (Standard)	35 min.	2 hr. 21 min.	9 hr. 27 min.	120	861
Full HD	59.94	50.00	IPB (Standard)	1 hr. 10 min.	4 hr. 43 min.	18 hr. 52 min.	60	432
	29.97 23.98	25.00	IPB (Standard)	2 hr. 20 min.	9 hr. 23 min.	37 hr. 35 min.	30	217
HD	59.94	50.00	IPB (Standard)	2 hr. 42 min.	10 hr. 49 min.	43 hr. 19 min.	26	188
High Frame Rate movies	119.88	100.00	IPB (Standard)	1 hr. 22 min.	5 hr. 28 min.	21 hr. 52 min.	52	372
4K time-lapse movies	29.97	25.00	ALL-I	14 min.	56 min.	3 hr. 47 min.	300	2146
Full HD time-lapse movies	29.97	25.00	ALL-I	47 min.	3 hr. 9 min.	12 hr. 38 min.	90	644
Miniature effect movie	29.97 23.98	25.00	IPB (Standard)	2 hr. 20 min.	9 hr. 23 min.	37 hr. 35 min.	30	217

\* Bit rate only applies to video output, not audio or metadata.

\* Movie recording stops when the maximum recording time per movie is reached.

\* Sound is not recorded for approx. the last two frames when the compression method for movie recording quality is IPB (Standard). Moreover, the video and sound may be slightly out of sync when movies are played back in Windows.

## Card performance requirements (movie recording) [write/read speed]

Movie recording size				SD card
Movie recording	Frame rate (fps)		Compression method	
	NTSC	PAL		
4K UHD	23.98	25.00	IPB (Standard)	UHS Speed Class 3 or higher
Full HD	59.94	50.00	IPB (Standard)	SD Speed Class 10 or higher
	29.97 23.98	25.00	IPB (Standard)	SD Speed Class 6 or higher
HD	59.94	50.00	IPB (Standard)	SD Speed Class 4 or higher
High Frame Rate movies	119.88	100.00	IPB (Standard)	SD Speed Class 10 or higher
4K time-lapse movies	29.97	25.00	ALL-I	Read speed of 40 MB/s or higher
Full HD Time-lapse movies	29.97	25.00	ALL-I	Read speed of 20 MB/s or higher
Miniature effect movie	29.97	25.00	IPB (Standard)	SD Speed Class 6 or higher
	23.98			

\* When set to [  Digital IS: Disable].

**Built-in microphone:** Monaural microphone

**External microphone (External microphone IN terminal):**  $\Phi$ 3.5 mm diameter stereo mini jack

## Autofocus

### Focusing method

Still photo shooting, Full HD or HD movie recording: Dual Pixel CMOS AF

4K movie recording: Contrast AF

\* With Contrast AF as used when recording 4K movies, focusing may take longer than when recording Full HD or HD movies, and focusing with certain lenses may be difficult.

### Focusing brightness range

Still photo shooting: EV -4.0 to 20

(With an f/1.2 lens,\* center AF point, One-Shot AF at room temperature, and ISO 100)

\* Except RF lenses with a Defocus Smoothing (DS) coating

Movie recording: EV -2.0 to 20

(With an f/1.2 lens,\* center AF point, One-Shot AF at room temperature, and ISO 100)

\* Except RF lenses with a Defocus Smoothing (DS) coating

\* During Full HD (29.97/25.00 fps) recording

### Focusing operation

	Still photo shooting	Movie recording
AF operation	<ul style="list-style-type: none"><li>• One-Shot AF*<sup>1</sup></li><li>• Servo AF*<sup>1</sup></li></ul>	<ul style="list-style-type: none"><li>• One-Shot AF</li><li>• Movie Servo AF</li></ul>
Manual focus (MF)	Supported	Supported

\* 1: Available in Creative Zone modes. Automatically set in Basic Zone modes to suit the shooting mode.

\* In < **A+** > mode, the camera automatically switches from One-Shot AF to Servo AF in response to subject movement.

### Focus mode: AF / MF

\* Applies when an RF or RF-S lens without a focus mode switch is used.

\* When lenses with a focus mode switch are used, the setting on the lens takes precedence.

**Lens compatibility based on focusing area:** Refer to the Canon website

## Number of AF area available for automatic selection

Focusing area		Horizontal: Approx. 88%, Vertical: Approx. 100%
Number of AF zones	Still photos	Max. 143 zones (13×11)
	Movies	Max. 117 zones (13×9)

\* May vary depending on settings.

## Selectable positions for AF point

Focusing area		Horizontal: Approx. 88%, Vertical: Approx. 100%
Numbers of positions	Still photos	Max. 3975 positions (75×53)
	Movies	Max. 3375 positions (75×45)

\* When set to [1-point AF] and selected using the cross keys.

\* Values for the selectable positions for AF points do not represent AF performance.



## Viewfinder

**Type:** OLED color electronic viewfinder

**Screen size:** Approx. 1.0 cm (0.39 inch)

**Dot count:** Approx. 2,360,000 dots

**Magnification / Angle of view:** Approx.  $0.95\times/28.0^\circ$  (3:2 aspect ratio, with 50mm lens at infinity,  $-1\text{ m}^{-1}$ )

**Coverage:** Approx. 100% (at JPEG Large image quality, a 3:2 aspect ratio, and approx. 22 mm eyepoint)

**Eyepoint:** Approx. 22 mm (at  $-1\text{ m}^{-1}$  from eyepiece lens end)

**Dioptric adjustment:** Approx.  $-3.0$  to  $+1.0\text{ m}^{-1}$  (dpt)

## Screen

**Type:** TFT color, liquid-crystal monitor

**Screen size:** Approx. 7.5 cm (3.0 inch) (screen aspect ratio of 3:2)

**Dot count:** Approx. 1,040,000 dots

**Angle of view:** Approx.  $150^\circ$  vertically and horizontally

**Coverage:** Approx. 100% vertically and horizontally (at L image size and an aspect ratio of 3:2)

**Screen brightness:** Manually adjustable in a range of 1–7

## HDMI output

**HDMI video / audio output:** HDMI micro OUT terminal (Type D)

\* HDMI CEC not supported

**HDMI resolution:** Auto / 1080p

## Exposure control

### Metering functions under various shooting conditions

Item		Still photo shooting	Movie recording
Metering method		384-zone (24×16) metering using image sensor output signals	
Metering mode	Evaluative metering	Yes	Set automatically when faces are detected with [L+Tracking]
	Partial metering	Yes * Approx. 5.8% in the center of the screen	
	Spot metering*1	Yes * Approx. 2.9% in the center of the screen	
	Center-weighted average metering	Yes	Set automatically when faces are not detected with [1-point AF], [Zone AF], or [L+Tracking]
Metering brightness range (at room temperature, ISO 100)		EV -2 to 20	EV 0 to 20

\* 1: Multi-spot metering not available (not supported).

### ISO speed (recommended exposure index) in still photo shooting

#### Manual ISO speed setting for still photos

	ISO speed
Normal ISO speed	ISO 100–12800 (in 1/3- or 1-stop increments)
Expanded ISO speed	H (equivalent to ISO 25600)

\* When set to [Highlight tone priority], the available manual setting range is ISO 200–12800.



#### Manual ISO speed setting range for still photos: Not supported

#### ISO Auto maximum limit setting for still photos

Max. for ISO Auto	ISO 400 / 800 / 1600 / 3200 / 6400 / 12800
-------------------	--

#### ISO Auto setting range for still photos: Not supported

## ISO Auto details for still photos

Shooting mode		No flash	Using flash*5
Creative Zone	P / Tv / Av / M (other than bulb)	ISO 100*1*2–12800*2	ISO 100*1*2–1600*2
	M (bulb)	ISO 400*3	ISO 400*3
Basic Zone	 / 	ISO 100–6400	ISO 100–3200*4
	<b>SCN</b>	Varies by shooting mode	
		Varies by shooting mode	

\* 1: ISO 200 when set to **[Highlight tone priority: Enable/Enhanced]**.

\* 2: Varies depending on the **[Max for Auto]** settings.

\* 3: If outside the setting range, changed to the value closest to ISO 400.

\* 4: When using the built-in flash. ISO 1600 when using an external flash unit.

\* 5: Can be used with lenses that do and do not support variable control of maximum ISO Auto limit for E-TTL.

**Variable control of maximum ISO Auto limit for E-TTL:** Supported

## ISO speed (recommended exposure index) in movie recording

### Manual ISO speed setting for movies

	Full HD / HD	4K
Normal ISO speed	ISO 100 to 12800* <sup>1</sup> (in 1/3-stop increments)	ISO 100 to 6400* <sup>2</sup> (in 1/3-stop increments)
Expanded ISO speed	H (equivalent to ISO 25600)* <sup>1</sup>	

\* 1: When set to **[Highlight tone priority]**, the setting range is ISO 200–12800.

\* 2: When set to **[Highlight tone priority]**, the setting range is ISO 200–6400.

### Automatic ISO speed setting for movies (with ISO Auto)

	Full HD / HD	4K
Normal ISO speed	ISO 100 to 12800* <sup>1</sup> (in 1/3-stop increments)	ISO 100 to 6400* <sup>2</sup> (in 1/3-stop increments)
Expanded ISO speed	H (equivalent to ISO 25600)* <sup>1</sup>	

\* Maximum ISO speed when set automatically corresponds to the **[Max for Auto]** setting.

\* 1: When set to **[Highlight tone priority]**, the setting range is ISO 200–12800.

\* 2: When set to **[Highlight tone priority]**, the setting range is ISO 200–6400.

**Manual ISO speed setting range limit for movies:** Not supported

### Maximum ISO Auto setting for movies

Max. for ISO Auto	ISO 6400 / 12800 / H (equivalent to ISO 25600)
-------------------	--

**Maximum ISO Auto setting for time-lapse movies:** Not supported

## Shutter

### Still photo shooting

#### Type:

Electronically controlled focal-plane shutter

\* Electronic 1st / mechanical 2nd curtain

\* Except in Silent shutter mode

Rolling shutter, using the image sensor

\* Electronic shutter

\* In Silent shutter mode

#### Shutter mode

Shutter mode	Flash photography
Electronic 1st-curtain	Possible
Electronic shutter	Disabled

#### Shutter speed / X-sync speed

Creative Zone: 1/4000–30 sec.,\*<sup>1</sup> Bulb\*<sup>2</sup>

Basic Zone: 1/4000–1 sec.\*<sup>3</sup>

Maximum flash sync speed: 1/250 sec.

\* 1: In 1/3-stop increments

\* 2: In manual shooting mode only

\* 3: Varies by mode.

#### Movie recording

**Type:** Rolling shutter, using the image sensor

#### Shutter speed:

Movie auto exposure: 1/4000–1/25\*<sup>1</sup> sec.

Movie manual exposure: 1/4000–1/8 sec.

\* 1: Varies by frame rate.

## Drive

### Drive mode and continuous shooting speed

(Max. approx.)

Drive mode	AF operation	Electronic 1st-curtain	Electronic shutter
Single shooting	One-Shot AF / Servo AF	Yes	Yes
Continuous shooting	One-Shot AF	6.5 shots/sec.	Not supported
	Servo AF	3.5 shots/sec.	Not supported
Self-timer: 10 sec./remote control		Yes	Yes
Self-timer: 2 sec./remote control		Yes	Yes
Self-timer: Continuous shooting		Yes	Not supported

## Built-in flash

**Type:** Retractable flash

**Retraction method:** Manual

**Guide no.:** Guide no. of approx. 6 (ISO 100/m) / 19.7 (ISO 100/feet)

**Flash exposure compensation:**  $\pm 2$  stops (in 1/3-stop increments)

**Effective flash range (example)**

(Approx.)

ISO speed	Lens: RF-S18-45mm F4.5-6.3 IS STM			
	Wide-angle end f/4.5		Telephoto end f/6.3	
	m	ft.	m	ft.
100	0.3–1.2	1.0–3.9	0.4–0.9	1.3–3.0
1600	1.2–4.9	3.9–16.1	0.9–3.5	3.0–11.5
12800	3.5–13.8	11.5–45.3	2.5–9.9	8.2–32.5

\* Rounded to the first decimal place.

\* Suitable exposure may not be obtained when shooting distant subjects at high ISO speeds, because preflash metering limits may be exceeded.

## External flash

**Accessory shoe contacts:** 5-pin contact

**Flash exposure compensation:**  $\pm 2$  stops (in 1/3-stop increments)

\* When set from the camera menu

## Playback

Item	Still photos	Movies
AF point display	Yes	
Magnified view	1.5×--10× (15 levels)	
Set image search conditions	Search conditions Rating / Date / Folder / Protection / Type of file (1) / Type of file (2)	
Rating	OFF / ★ to ★★★★★ Select images / Select range / All images in folder / All images on card / All found images	
Protect images	Select images / Select range / All images in folder / Unprotect all images in folder / All images on card / Unprotect all images on card / All found images / Unprotect all found images	

## Frame grab from 4K movies

Individual frames of 4K movies recorded with the camera can be saved as approx. 8.3-megapixel (3840×2160) still photos (JPEG).

\* In-camera resizing or cropping is not supported for extracted still photos, and these images cannot be edited with Creative filters or Creative Assist.

## Print order (DPOF)

Compliant with DPOF Version 1.1

## External interface

### Digital terminal

**Terminal type:** USB Type-C

**Transmission:** Equivalent to Hi-Speed USB (USB 2.0)

**Applications:** For PC communication

\* Cannot be connected to a printer

\* Not for communication with smartphones

\* Charging and powering the camera via USB are not supported

**HDMI output terminal:** HDMI micro OUT terminal (Type D)

**External microphone IN terminal:** 3.5 mm diameter stereo mini jack

**Remote control terminal:** Terminal compatible with Remote Switch RS-60E3



## Power source

### Battery

Compatible battery pack	LP-E17
Quantity used	1

**Battery check:** Automatic battery check with 4-level display when the power switch is set to ON.

**Battery information:** Not supported

**USB battery charging and camera power supply:** Not supported

### AC power source

AC adapter	AC-E6N
DC coupler	DR-E18

### Number of shots available

Type of shooting	Temperature	Available shots (approx.)		
		Using 50% flash		AE shooting* <sup>2</sup>
		Power saving* <sup>1</sup>	Smooth* <sup>2</sup>	Power saving
Viewfinder shooting	+23°C / 73°F	320	320	340
On-screen shooting		400	320	430

\* 1: Based on CIPA standards.

\* 2: According to Canon measurement conditions, which are based on CIPA standards.

\* Using a new, fully charged LP-E17

\* The number of shots available may vary greatly depending on the shooting environment.

## Available operating time

Conditions of use			Temperature	Available operating time
Time available for bulb exposure			23°C / 73°F	Approx. 3 hr. 20 min.
Time available for Live View shooting * Using the screen			23°C / 73°F	Approx. 3 hr. 00 min.
Time available for movie recording * Movie Servo AF: Disable	4K	<ul style="list-style-type: none"> <li>• IPB (Standard)</li> <li>• 23.98 fps / 25.00 fps</li> </ul>	23°C / 73°F	Approx. 1 hr. 50 min.
			0°C / 32°F	Approx. 1 hr. 50 min.
	Full HD	<ul style="list-style-type: none"> <li>• IPB (Standard)</li> <li>• 29.97 fps / 25.00 fps</li> </ul>	23°C / 73°F	Approx. 2 hr. 40 min.
			0°C / 32°F	Approx. 2 hr. 30 min.
Time available for continuous playback (normal playback)	4K	<ul style="list-style-type: none"> <li>• IPB (Standard)</li> <li>• 23.98 fps / 25.00 fps</li> </ul>	23°C / 73°F	Approx. 3 hr. 10 min.

\* With a new, fully charged LP-E17

## Dimensions and weight

### Dimensions

(W) × (H) × (D)	Approx. 116.3 × 85.5 × 68.8 mm / Approx. 4.58 × 3.37 × 2.71 in.
-----------------	---

\* Based on CIPA guidelines.

### Weight

	Weight
Body (including battery and card)*1	Approx. 356 g / Approx. 12.56 oz.
Body only	Approx. 309 g / Approx. 10.90 oz.

\* Not including body cap.

\* 1: Based on CIPA guidelines.

### Operating environment

**Operating temperature:** 0–40°C / 32–104°F

**Operating humidity:** 85% or less

## Wi-Fi (wireless LAN)

### Supported standards (equivalent to IEEE 802.11b/g/n standards)

Wi-Fi standards	Transmission method	Maximum link speed
IEEE 802.11b	DSSS modulation	11 Mbps
IEEE 802.11g	OFDM modulation	54 Mbps
IEEE 802.11n		72.2 Mbps

\* Not compatible with MIMO (Multiple-input and multiple-output).

### Transmission frequency (Center frequency)

Frequency	2412 to 2462 MHz
Channels	1 to 11 ch

### Authentication and data encryption methods

Connection method	Authentication	Encryption
		Encryption method
Camera access point	WPA2-PSK	AES
	Open	Disable
Infrastructure	Open	WEP
		Disable
	Shared key	WEP
	WPA-PSK	TKIP AES
WPA2-PSK		

## Bluetooth

**Standards compliance:** Bluetooth Specification Version 4.2 compliant (Bluetooth Low Energy technology)

**Transmission method:** GFSK modulation

- All data above is based on Canon testing standards and CIPA (Camera & Imaging Products Association) testing standards and guidelines.
- Dimensions and weight listed above are based on CIPA Guidelines (except weight for camera body only).
- Product specifications and appearance are subject to change without notice.
- If a problem occurs with a non-Canon lens attached to the camera, contact the respective lens manufacturer.

# Trademarks and Licensing

---

[✔ Trademarks](#)

[✔ About MPEG-4 Licensing](#)

[✔ Accessories](#)

## Trademarks

---

- Adobe is a trademark of Adobe Systems Incorporated.
- Microsoft and Windows are trademarks or registered trademarks of Microsoft Corporation in the United States and/or other countries.
- App Store and macOS are trademarks of Apple Inc., registered in the U.S. and other countries.
- Google Play and Android are trademarks of Google LLC.
- IOS is a trademark or registered trademark of Cisco in the U.S. and other countries and is used under license.
- QR Code is a trademark of Denso Wave Inc.
- SDXC logo is a trademark of SD-3C, LLC.
- HDMI, HDMI logo, and High-Definition Multimedia Interface are trademarks or registered trademarks of HDMI Licensing LLC.
- The Wi-Fi CERTIFIED logo and the Wi-Fi Protected Setup mark are trademarks of the Wi-Fi Alliance.
- The Bluetooth® word mark and logos are registered trademarks owned by Bluetooth SIG, Inc. and any use of such marks by Canon Inc. is under license. Other trademarks and trade names are those of their respective owners.
- USB Type-C™ and USB-C™ are trademarks of USB Implementers Forum.
- All other trademarks are the property of their respective owners.



## About MPEG-4 Licensing

---

"This product is licensed under AT&T patents for the MPEG-4 standard and may be used for encoding MPEG-4 compliant video and/or decoding MPEG-4 compliant video that was encoded only (1) for a personal and non-commercial purpose or (2) by a video provider licensed under the AT&T patents to provide MPEG-4 compliant video. No license is granted or implied for any other use for MPEG-4 standard."

THIS PRODUCT IS LICENSED UNDER THE AVC PATENT PORTFOLIO LICENSE FOR THE PERSONAL USE OF A CONSUMER OR OTHER USES IN WHICH IT DOES NOT RECEIVE REMUNERATION TO (i) ENCODE VIDEO IN COMPLIANCE WITH THE AVC STANDARD ("AVC VIDEO") AND/OR (ii) DECODE AVC VIDEO THAT WAS ENCODED BY A CONSUMER ENGAGED IN A PERSONAL ACTIVITY AND/OR WAS OBTAINED FROM A VIDEO PROVIDER LICENSED TO PROVIDE AVC VIDEO. NO LICENSE IS GRANTED OR SHALL BE IMPLIED FOR ANY OTHER USE. ADDITIONAL INFORMATION MAY BE OBTAINED FROM MPEG LA, L.L.C. SEE [HTTP://WWW.MPEGLA.COM](http://www.mpegla.com)

\* Notice displayed in English as required.

## Accessories

### Use of genuine Canon accessories is recommended

This product is designed to achieve optimum performance when used with genuine Canon accessories. Therefore, using this product with genuine accessories is highly recommended. Canon shall not be liable for any damage to this product and/or accidents such as malfunction, fire, etc. caused by the failure of non-genuine Canon accessories (e.g., a leakage and/or explosion of a battery). Please note that repairs arising out of the malfunction of non-genuine accessories will not be covered by the warranty for repairs, although you may request such repairs on a chargeable basis.

#### ⚠ Caution

- Battery Pack LP-E17 is dedicated to Canon products only. Using it with an incompatible battery charger or product may result in malfunction or accidents for which Canon cannot be held liable.

Check the following website for details on compatible accessories.

- <https://cam.start.canon/H002/>

