

Canon

SPEEDLITE EL-10



Advanced User Guide

E

Contents

Introduction.	4
Supplemental Information.	5
Compatible Accessories.	6
Instruction Manual.	7
About This Guide.	8
Safety Instructions.	10
Part Names.	12
Getting Started and Basic Operations.	22
Inserting Batteries.	23
Attaching and Detaching the Speedlite.	26
Turning on the Power.	28
Fully Automatic Flash Photography.	33
E-TTL II / E-TTL Autoflash, by Shooting Mode.	35
Advanced Flash Photography.	41
Flash Exposure Compensation.	42
FE Lock.	44
High-Speed Sync.	45
Second-Curtain Sync.	47
Bounce.	49
Flash Coverage Setting.	54
Manual Flash.	58
Modeling Flash.	65
Color Filter.	66
Clearing Speedlite Settings.	68
Setting Flash Functions from the Camera.	70
Flash Control from the Camera Menu.	71
Radio Transmission Wireless Flash Photography.	78
Radio Transmission Wireless Flash Photography.	79
Wireless Settings.	85
Autoflash with One Receiver.	97

Autoflash with Two Receiver Groups.	105
Autoflash with Three Receiver Groups.	109
Wireless Multiple-Flash Photography with Flash Ratio.	114
Shooting in Group-Specific Flash Modes.	117
Firing Test Flash/Modeling Flash from Receivers.	122
Remote Release from Receivers.	124
Linked Shooting.	125
Customizing the Speedlite.	130
Setting Custom and Personal Functions.	131
Customization with Custom Functions.	138
Customization with Personal Functions.	142
Custom Flash Modes.	144
Reference.	153
Flash Firing Restriction Due to Temperature Increase.	154
Troubleshooting Guide.	156
Specifications.	160
Accessories.	169

Introduction

Designed for EOS cameras equipped with a multi-function shoe, the Canon EL-10 is an external Speedlite compatible with E-TTL II / E-TTL autoflash. In normal flash photography, it can be used as an on-camera flash attached to a multi-function shoe, and in radio transmission wireless flash photography, it can be used as a sender or receiver.

Read before use

To avoid shooting problems and accidents, first read the [Safety Instructions](#). Also read this Advanced User Guide carefully to ensure correct use.

Read in conjunction with the camera instruction manual

Before use, read this guide and the Advanced User Guide of your camera to familiarize yourself with operations and ensure correct use.

*** Explanations in this guide are based on use with an EOS Digital camera.**

Precaution on continuous flash firing

Flash units fire repeatedly in continuous shooting with flash or when you shoot with features such as stroboscopic or modeling flash. Some people may experience seizures or similar symptoms from visual overstimulation caused by continuous flash firing (including light reflected off brightly colored walls or other surfaces). If you or others experience these symptoms, stop firing the flash units immediately.

- [Supplemental Information](#)
- [Compatible Accessories](#)
- [Instruction Manual](#)
- [About This Guide](#)
- [Safety Instructions](#)
- [Part Names](#)

Supplemental Information

Check the following website for supplemental information about the Speedlite.

- <https://cam.start.canon/H001/>



Compatible Accessories

Check the following website for the latest compatible cameras and accessories.

- <https://cam.start.canon/H002/>



Instruction Manual



The included Instruction Manual provides basic instructions on flash photography.

- **Advanced User Guide**

Complete instructions are provided in this Advanced User Guide.
For the latest Advanced User Guide, refer to the following website.
<https://cam.start.canon/A009/>







About This Guide





 [Icons in This Guide](#)

 [Basic Assumptions](#)

Icons in This Guide

	Indicates the select dial.
	Indicates the  cross key directional buttons.
	Indicates the Select/Set button.
	Indicates the duration (approx. 12 or 16 sec.) of the operation for the button you pressed, based on when you release the button.

- In reference to buttons or setting positions, the guide uses the same icons or display items found on the Speedlite.

	Links to pages with related topics.
	Warning to prevent shooting problems.
	Supplemental information.
	☆ to the right of page titles indicates functions only available with the camera set to Creative Zone modes (<Fv>, <P>, <Tv>, <Av>, , or <M>).
	Troubleshooting tips.

Basic Assumptions

- Instructions apply to the Speedlite and camera with the power on (🔋).
- The icons used for buttons, dials, and symbols in the text match the icons found on the Speedlite and the camera.
- Instructions for selecting options when configuring functions are mainly explained using the < Ⓞ > dial for selection. You can also select by pressing the < ⬆️ > cross key directional buttons (< 🏠 >> **MODE** >> ⬅️ >> 🏠 > buttons).
- Function setup is exited by pressing the < ↶ > button.
- Default settings are assumed for Custom/Personal Functions of the Speedlite, as well as menu functions/Custom Functions of the camera.
- The numerical values are measured according to Canon testing standards using four AA/LR6 alkaline batteries.

Safety Instructions

Be sure to read these instructions in order to operate the product safely.
Follow these instructions to prevent injury or harm to the operator of the product or others.

 **WARNING:** Denotes the risk of serious injury or death.

- Keep the product out of the reach of young children.
The cover is dangerous if swallowed. If swallowed, seek immediate medical assistance.
- Use only power sources specified in this instruction manual for use with the product.
- Do not disassemble or modify the product.
- Do not expose the product to strong shocks or vibration.
- Do not touch any exposed internal parts.
- Stop using the product in any case of unusual circumstances such as the presence of smoke or a strange smell.
- Do not use organic solvents such as alcohol, benzene or paint thinner to clean the product.
- Do not get the product wet. Do not insert foreign objects or liquids into the product.
- Do not use the product where flammable gases may be present.

This may cause electric shock, explosion or fire.

- Observe the following instructions when using commercially available batteries or provided battery packs.
 - Use batteries/battery packs only with their specified product.
 - Do not heat batteries/battery packs or expose them to fire.
 - Do not charge batteries/battery packs using non-authorized battery chargers.
 - Do not expose the terminals to dirt or let them come into contact with metallic pins or other metal objects.
 - Do not use leaking batteries/battery packs.
 - When disposing of batteries/battery packs, insulate the terminals with tape or other means.

This may cause electric shock, explosion or fire.

If a battery/battery pack leaks and the material contacts your skin or clothing, flush the exposed area thoroughly with running water. In case of eye contact, flush thoroughly with copious amounts of clean running water and seek immediate medical assistance.

- Do not allow the product to maintain contact with the same area of skin for extended periods of time during use.

This may result in low-temperature contact burns, including skin redness and blistering, even if the product does not feel hot.

- Follow any indications to turn off the product in places where its use is forbidden.

Not doing so may cause other equipment to malfunction due to the effect of electromagnetic waves and even result in accidents.



CAUTION:

Follow the cautions below. Otherwise physical injury or property damage may result.

- Do not fire the flash near the eyes.

It may hurt the eyes.

- Flash emits high temperatures when fired. Keep fingers, any other part of your body, and objects away from the flash unit while taking pictures.

This may cause burns or malfunction of the flash.

- Do not leave the product in places exposed to extremely high or low temperatures.

The product may become extremely hot/cold and cause burns or injury when touched.

- Do not touch any parts inside the product.

This may cause injury.

Part Names

[LCD Panel](#)

[Included Accessories](#)

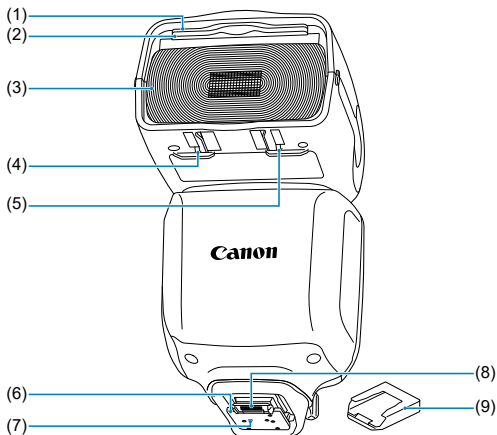

(1) Catchlight panel (shown stowed)

(2) Wide panel (shown stowed)

(3) Flash head (light-emitting unit)

(4) Bounce adapter detector

(5) Color filter detector

(6) Mounting foot

(7) Mounting foot locking pin

(8) Contacts

(9) Mounting foot cover

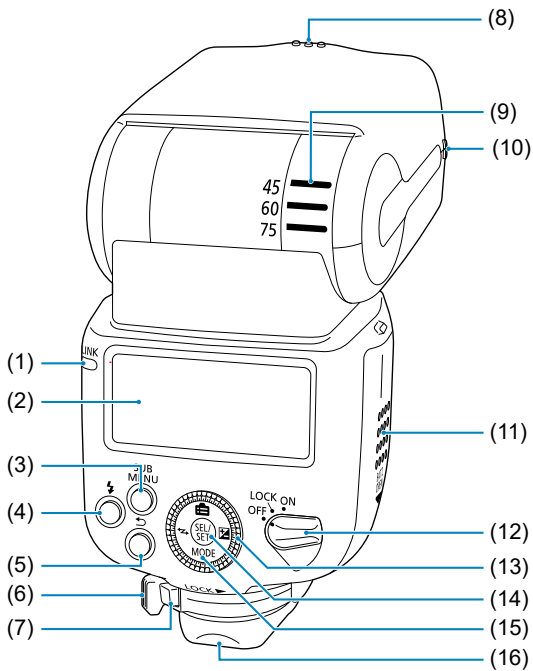

-
- (1) <LINK> Radio transmission confirmation lamp
-
- (2) LCD panel
-
- (3) <^{SUB}_{MENU}> Sub menu button
-
- (4) <⚡> Flash-ready lamp / test flash button
-
- (5) <↶> Undo button
-
- (6) Mounting foot lock lever
-
- (7) Lock-release button
-
- (8) Color filter mount
-
- (9) Bounce angle index
-
- (10) Bounce adapter mount
-
- (11) Battery compartment cover
-
- (12) Power switch
<ON> Power ON
<LOCK> Button / dial lock (Power ON)
<OFF> Power OFF
-
- (13) <⊙> Select dial
-
- (14) <⊕> Select/Set button
-
- (15) <⚡> Cross keys
<☰> Menu direct
<MODE> Flash mode
<↔> Wireless / linked shooting setting
<⊞> Flash exposure compensation / flash output setting
-
- (16) Dust-proof and drip-proof adapter
-

E-TTL II / E-TTL autoflash (🔗)

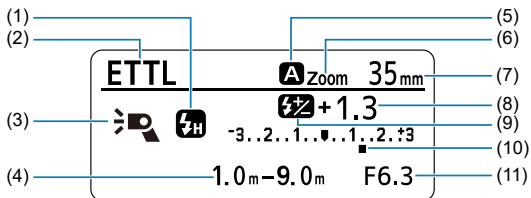

(1) <🔗> First-curtain sync (normal shooting)

<🔗> Second-curtain sync

<🔗> High-speed sync

(2) <**ETTL**> E-TTL II / E-TTL autoflash

<**C1**> / <**C2**> / <**C3**> Custom flash mode*1

(3) <🔗> Standard

<🔗> Guide number priority

<🔗> Even coverage

<🔗> Bounce

<🔗> Bounce adapter attached

<🔗> Color filter attached

<🔗> Temperature increase (flash firing restriction)

(4) Effective flash range / shooting distance

<**m**> Value in meters

<**ft**> Value in feet

(5) <**CHARGE**> Charge indicator

<**A**> Auto

<**M**> Manual

(6) <**Zoom**> Zoom indicator

<🔗 **WP**> Wide panel + bounce warning

<🔗 **WIDE**> Out of flash coverage range warning

(7) Flash coverage (focal length)

(8) Flash exposure compensation amount

(9) <🔗> Flash exposure compensation

(10) Flash exposure level

(11) <**F**> Aperture value

* 1: The flash mode is identified after the indicator for the current Custom flash mode.

Manual flash (🔗)

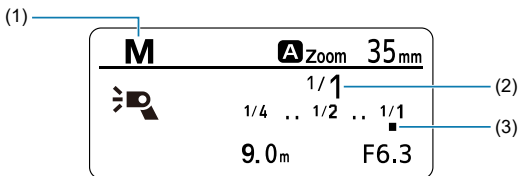

(1) <M> Manual flash
<C1> / <C2> / <C3> Custom flash mode*1

(2) Manual flash output

(3) Manual flash level

* 1: The flash mode is identified after the indicator for the current Custom flash mode.

Note

- These are only examples of display. Actual display only shows current settings.
- The LCD panel is illuminated in response to button or dial operations (🔗).

Radio transmission wireless flash photography (🔗)

● Sender unit

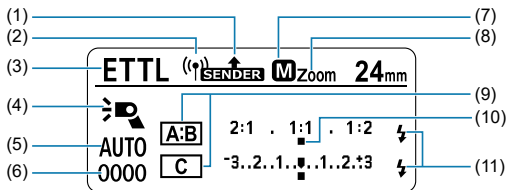

-
- (1) < **SENDER** > Configured as a sender
< **SUB SENDER** > Configured as a sub-sender
-
- (2) < (🔗) > Radio transmission wireless
-
- (3) Flash mode
< **ETTL** > E-TTL II / E-TTL autoflash
< **M** > Manual flash
< **Gr** > Group firing
< **C1** > / < **C2** > / < **C3** > Custom flash mode*¹
-
- (4) < 📡 > Sender flash firing ON
< 📡 > Sender flash firing OFF
-
- (5) < **Ch** > Transmission channel
< **AUTO** > Transmission channel set automatically
-
- (6) Wireless radio ID
-
- (7) < **CHARGE** > Sender / receiver charge indicator
-
- (8) < ⚡ > Synchronization speed warning
-
- (9) Firing group control
-
- (10) Flash ratio
-
- (11) < 🔋 > Receiver fully charged

* 1: The flash mode is identified after the indicator for the current Custom flash mode.

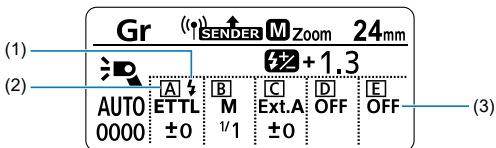

(1) < **CHARGE** > Receiver fully charged

(2) Firing group control

(3) Group firing mode*¹

* 1: < **Gr** > Group firing only

Note

- < **CHARGE** > is no longer displayed after senders and receivers in radio transmission wireless flash photography are fully charged.
- < **ETTL** >, < **M** >, < **Ext.A** >, and < **OFF** > are available as flash modes for < **Gr** > group firing.

● Receiver unit

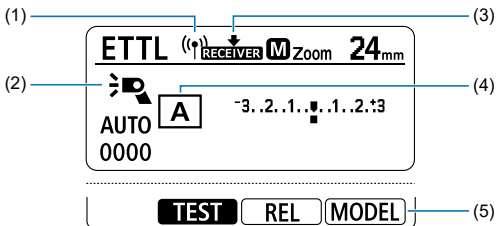

(1) < ((P)) > Radio transmission wireless

(2) < [Receiver Icon] > Receiver

(3) < RECEIVER > Configured as a receiver

(4) Firing group

(5) < TEST > Test flash

< REL > Remote release

< MODEL > Modeling flash

Radio transmission: linked shooting (2)

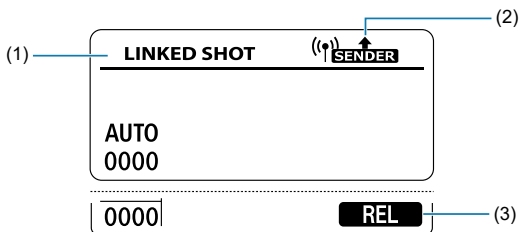

(1) < **LINKED SHOT** > Linked shooting
< **C1** > / < **C2** > / < **C3** > Custom flash mode*¹

(2) < **SENDER** > Configured as a sender
< **RECEIVER** > Configured as a receiver

(3) < **REL** > Release*²

* 1: The flash mode is identified after the indicator for the current Custom flash mode.

* 2: < **SENDER** > Only when configured as a sender.

Included Accessories

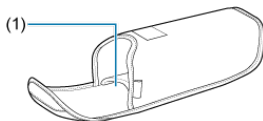

Speedlite case

(1) Mini stand storage pocket

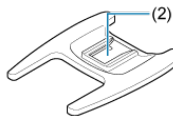

Mini stand

(2) Mounting part

Getting Started and Basic Operations

This chapter describes the preparations before starting flash photography and the basic shooting operations.

Caution

Precautions on continuous flash firing

- To avoid wearing out or damaging flash heads from overheating, do not fire the flash continuously at full output more than approx. 32 times. After firing continuously at full output this many times, stop using the Speedlite for at least 35 min.
- After continuous firing at full output this many times, further continuous firing at short intervals may activate a safety function that restricts firing. At a firing restriction level of 1, the firing interval is automatically set to approx. 10 sec. In this case, stop using the Speedlite for at least 35 min.
- For details, see [Flash Firing Restriction Due to Temperature Increase](#).

- [Inserting Batteries](#)
- [Attaching and Detaching the Speedlite](#)
- [Turning on the Power](#)
- [Fully Automatic Flash Photography](#)
- [E-TTL II / E-TTL Autoflash, by Shooting Mode](#)

Inserting Batteries

The unit is powered by four AA/R6 batteries. You can use AA/LR6 alkaline batteries or AA/HR6 Ni-MH batteries.

Caution

- **Do not use AA/R6 lithium batteries.**

In rare cases when using some AA/R6 lithium batteries, the batteries can get very hot. For your own safety, refrain from using AA/R6 lithium batteries.

- As the contact shape of non-alkaline AA/R6 batteries is not standardized, poor contact may occur depending on the battery type.

1. Open the cover.

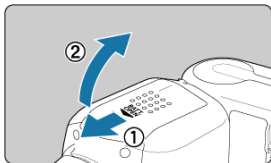

- Slide the battery compartment cover down to open it.

2. Insert batteries.

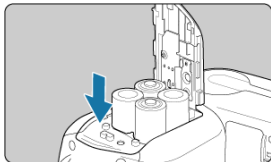

- Insert the batteries as indicated, not mistaking the "+" and "-" marks.

3. Close the cover.

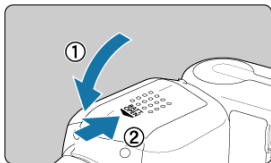

- Reversing step 1, close the battery compartment cover and slide it up.

Firing interval and flash count

EL-10 alone

Firing Interval		Flash Count
Quick Flash	Normal Flash	
Approx. 0.1–2.2 sec.	Approx. 0.1–2.5 sec.	Approx. 210–1,400 times

* The Quick flash function enables flash photography before the flash is fully charged (🔋).

* Numerical values measured according to Canon testing standards using new AA/LR6 alkaline batteries.

Caution

- **Do not touch the flash head, battery, or near the battery compartment after continuous flash firing.**

After repeated use of continuous flash or modeling flash at short intervals, do not touch the flash head, battery, or near the battery compartment. The flash head, battery, and area near the battery compartment may become hot, which poses a risk of burns.

- **Do not allow the product to maintain contact with the same area of skin for extended periods of time during use.**

This may result in low-temperature contact burns, including skin redness and blistering, even if the product does not feel hot.



Note

- Batteries should be replaced with new batteries when <  > is displayed, or if the LCD panel goes blank during flash recharging.
- All four batteries should be brand new and of the same brand. Replace all four batteries at the same time.

Attaching and Detaching the Speedlite

1. Attach the Speedlite.

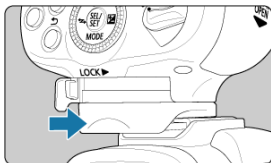

- Remove the camera shoe cover and Speedlite mounting foot cover.
- Insert the Speedlite slowly, making sure the Speedlite mounting foot is aligned with the camera multi-function shoe.
- Insert the Speedlite mounting foot **all the way** into the hot shoe.

2. Secure the Speedlite.

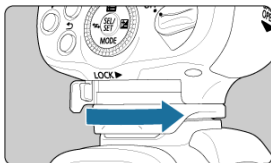

- Slide the mounting foot lock lever to the right.
- The lock lever is locked when it clicks into place.

3. Detach the Speedlite.

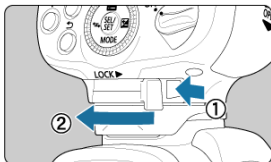

- While pressing the lock-release button, slide the lock lever left and remove the Speedlite.

 **Caution**

- Be sure to turn off the Speedlite before attaching or detaching it.
- Do not attach to cameras without a multi-function shoe. Forcing it onto the camera may result in damage.
- Do not allow hard objects to touch the contacts. This may damage the camera.
- Do not touch the contacts with your fingers. This may lead to corrosion. Corroded contacts may cause malfunctioning.
- Blow off any foreign material on the contacts with a commercially available blower or similar tool.
- Allow the contacts to dry before use if it gets wet.

Turning on the Power

- ☑ [Quick Flash](#)
- ☑ [Auto Power Off](#)
- ☑ [Locking Flash Operations](#)
- ☑ [LCD Panel Illumination](#)

1. Turn the power switch to <ON>.

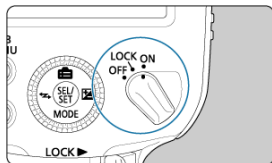

- Flash recharging begins.
- < **CHARGE** > appears on the LCD panel during recharging. The LCD display will turn off once recharging is complete.

2. Confirm that flash recharging is finished.

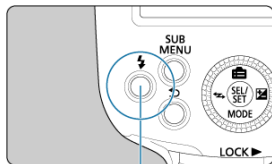

(1)

- The flash-ready lamp changes as follows: **off** → **red (blinking)** (Quick flash ready) → **red (lit)** (fully charged).
- To fire a test flash, press the test flash button (flash-ready lamp, (1)).

Caution

- Test flash firing is not available while a camera's metering timer is active.

Note

- Flash settings are retained even after the power is turned off. To retain settings when replacing the batteries, turn the power off before replacing.

Quick Flash

Quick flash enables flash photography even when the flash-ready lamp is still blinking in red (before fully charged). It is available in all camera drive modes. Although flash output is limited to approx. 1/2 to 1/6 of full output, this feature is useful for shooting with a shorter firing interval.

In manual flash photography, Quick flash is available when the flash output is set to 1/4 to 1/1024. Note that Quick flash is not available for wireless flash photography.

Caution

- Using Quick flash in continuous shooting may cause underexposure, due to the reduced flash output.

Note

- For details on < **CHARGE** > display when the Speedlite is set as a sender in radio transmission wireless flash photography, see [LCD Panel Illumination](#).
- Quick flash can be disabled in [P.Fn-02](#).

Auto Power Off

This feature conserves battery power by turning the Speedlite off automatically if it is left idle for approx. 90 sec. To restore power to the Speedlite, either press the camera shutter button halfway or press the test flash button (flash-ready lamp).

Auto power off takes effect in approx. 5 min. when the Speedlite is set as a sender in radio transmission wireless flash photography (☑) or configured for linked shooting (☑).



Note

- Auto power off can be disabled in [C.Fn-01](#).
- When attached to a camera, the Speedlite turns off automatically if left idle for approx. 90 sec. after the camera power is turned off.

Locking Flash Operations

Button and dial operations of the Speedlite can be disabled by setting the power switch to <LOCK>. This can help prevent accidentally changing the Speedlite settings. <LOCKED> is displayed on the LCD panel in response to button or dial operations.



Note

- Even with the power switch set to <LOCK>, test flash firing is available. Note that the LCD panel is illuminated in response to button or dial operations.

LCD Panel Illumination

The LCD panel is illuminated for approx. 12 sec. (⌚12) in response to button or dial operations.

For details on LCD panel illumination when the Speedlite is set as a sender in radio transmission wireless flash photography, see [LCD Panel Illumination](#).



Note

- LCD panel illumination can be changed in [C.Fn-22](#).

Fully Automatic Flash Photography

E-TTL II and E-TTL fully automatic flash shooting is available when the camera is set to <P> (Program AE) or fully automatic shooting mode.

1. Press the <MODE> button on the <⇨> cross keys.

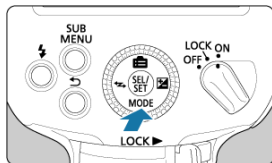

2. Select <ETTL>.

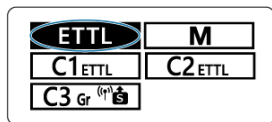

- Turn the <⊙> dial to select <ETTL>, then press <⊙>.

3. Focus on the subject.

- Press the shutter button halfway to focus.
- The shutter speed and aperture value are displayed in the viewfinder.
- Confirm that <⚡> appears in the viewfinder.

4. Take the picture.

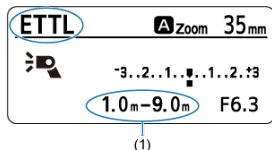

* This is an example of display when the camera is in < **P** > (Program AE) mode.

- Confirm that the subject is within the effective flash range (1).
- Pressing the shutter button completely fires the flash and takes a picture.

Note

- If the subject in your shot looks dark (underexposed), try approaching the subject before you shoot again. You can also try increasing the ISO speed.
- Fully automatic modes include < **A**⁺ >, < **□** >, and < **CA** >.
- < **ETTL** > is shown on the LCD panel, even when the Speedlite is used with cameras supporting E-TTL II.
- After shooting, turn off the camera and Speedlite, remove the Speedlite from the camera, and attach the mounting foot cover before storage.

E-TTL II / E-TTL Autoflash, by Shooting Mode

- [Auto Zoom for Sensor Size](#)
- [Transmission of Color Temperature Information](#)
- [AF-Assist Beam](#)
- [Check Firmware Version / Certification Logo](#)

E-TTL II or E-TTL autoflash suitable for the current shooting mode is used automatically – simply set the camera shooting mode to < **Tv** > (shutter-priority AE), < **Av** > (aperture-priority AE), < **Fv** > (flexible-priority AE), or < **M** > (manual exposure).

Tv	<p>Select this mode when you want to set the shutter speed manually. The camera sets a suitable aperture value for the shutter speed to obtain standard exposure based on metering by the camera.</p> <ul style="list-style-type: none">● Aperture values blink to warn about underexposed or overexposed backgrounds. Adjust the shutter speed until the aperture value stops blinking.
Av	<p>Select this mode when you want to set the aperture value manually. The camera sets a suitable shutter speed for the aperture value to obtain standard exposure based on metering by the camera.</p> <ul style="list-style-type: none">● Shooting with a tripod is recommended, because slow shutter speeds are used for low-light scenes.● Shutter speeds blink to warn about underexposed or overexposed backgrounds. Adjust the aperture value until the shutter speed stops blinking.
Fv	<p>Any shutter speed or aperture value can be set.</p> <ul style="list-style-type: none">● If the aperture value blinks when you set a shutter speed, adjust the shutter speed until the aperture value stops blinking.● If the shutter speed blinks when you set an aperture value, adjust the aperture value until the shutter speed stops blinking.
M	<p>Select this mode if you want to set both the shutter speed and aperture value manually. Light from the flash provides standard exposure for subjects. Background exposure varies depending on your specified shutter speed and aperture value.</p>

Flash sync speed and aperture value, by shooting mode

	Shutter Speed	Aperture Value
P	Automatic (1/X sec.–1/60 sec.)* ¹	Auto
Tv	Manual (1/X sec.–30 sec.)	Auto
Av	Automatic (1/X sec.–1/60 sec.)* ¹	Manual
Fv	Manual / automatic (at least 1/X sec.)	Auto / Manual
M	Manual (1/X sec.–30 sec., Bulb)	Manual

* 1/X sec. represents the camera's maximum flash sync shutter speed.

* 1: On cameras that support slow synchro, varies by settings.

Auto Zoom for Sensor Size

The Speedlite automatically recognizes the image sensor size of the EOS Digital camera and sets optimal flash coverage for the effective shooting angle of view of the lens in a focal length range of 24–105 mm.

Transmission of Color Temperature Information

This feature provides optimal white balance in flash photography by using color temperature information at the moment of firing, which is transmitted by the Speedlite to the EOS Digital camera. It is automatically enabled when camera white balance is set to < **AWB** >, < **AWBW** >, or <  >.

AF-Assist Beam

In conditions that make autofocus difficult, such as focusing in low-light scenes, the flash fires continuously (intermittent flash firing mode) to assist in autofocus. The AF-assist beam effective range is approx. 0.7–10 m at the center of the AF area.

Caution

- Focusing with the AF-assist beam of an external Speedlite may be difficult when using a peripheral AF point on the camera, or when using wide-angle or telephoto lenses. In this case, use the center AF point or an AF point near the center.

Note

- AF-assist beam firing can be disabled in [C.Fn-08](#).
- This beam may be emitted by the camera instead of by the Speedlite, depending on ambient brightness.

Check Firmware Version / Certification Logo

1. Press the **< SUB MENU >** button.

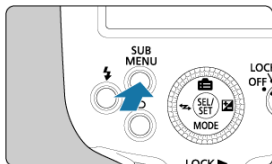

2. Display the information screen.

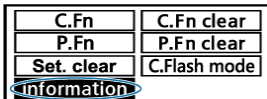

- Turn the **< (info) >** dial to select **< information >**, then press **< (info) >**.

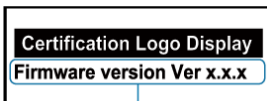

(1)

- Displays the firmware version (1) of the Speedlite.

3. Open certification logo display.



- Press **< (info) >**.
- You can check some of the Speedlite's certification logos. Other certification logos can be found on the Speedlite body and packaging.

Advanced Flash Photography

This chapter describes advanced shooting methods using Speedlite features.

Caution



- Features on pages with ☆ in the upper right are not available when the camera is in Full Auto or Basic Zone modes. All operations in this chapter are available with the camera shooting mode set to < **Fv** >, < **P** >, < **Tv** >, < **Av** >, < **M** > or < **Bulb (B)** > (Creative Zone).

- [Flash Exposure Compensation](#) ☆
- [FE Lock](#) ☆
- [High-Speed Sync](#) ☆
- [Second-Curtain Sync](#) ☆
- [Bounce](#)
- [Flash Coverage Setting](#) ☆
- [Manual Flash](#) ☆
- [Modeling Flash](#) ☆
- [Color Filter](#)
- [Clearing Speedlite Settings](#) ☆

Flash output is adjustable. The amount of flash exposure compensation can be set in a range of ± 3 stops, in $1/3$ -stop increments.

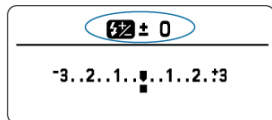
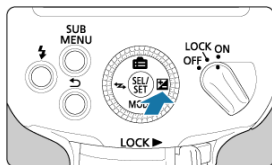

1. Press the  button on the  cross keys.



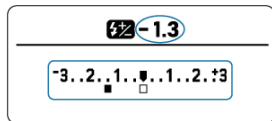
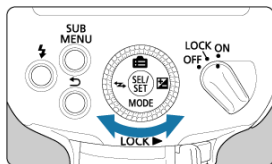

- Press  and turn the  dial to select the flash exposure compensation option.

2. Set the flash exposure compensation amount.



- Turn the <  > dial to select an exposure compensation amount, then press <  >.
- “0.3” represents 1/3 stop and “0.7,” 2/3 stop.
- To cancel flash exposure compensation, return the value to “±0.”
- After changing the value, the changed value will not be set if the <  > button is pressed.

Note

- In general, use positive compensation for bright subjects and negative compensation for dark ones.
- When exposure compensation is set in 1/2-stop increments on the camera, flash exposure compensation is set in a range of ±3 stops in 1/2-stop increments.
- The Speedlite setting takes precedence if flash exposure compensation is set on both the Speedlite and the camera.
- The flash exposure compensation amount can be set directly without pressing <  > on the <  > cross keys by turning the <  > dial [\(C.Fn-13\)](#).

Shooting with flash exposure (FE) locked provides suitable flash exposure over your specified area of the subject.

With < **ETTL** > displayed on the LCD panel, press the camera's < * > (AE lock) button.

1. Focus on the subject.



2. Press the < * > button (ⓘ16).

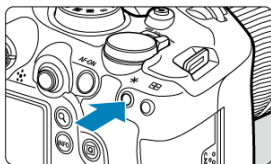

- Center the subject in the viewfinder, then press the camera's < * > button.
- The Speedlite fires a preflash and stores the flash output required for the subject.
- [FEL] appears in the viewfinder for about half a second.
- Each time you press the < * > button, the Speedlite fires a preflash and stores the flash output required at that time.

Note

- < ⚡ > blinks in the viewfinder if suitable exposure cannot be obtained with FE lock. Approach the subject or open the aperture, then try locking the flash exposure again. You can also try increasing the ISO speed before attempting FE lock again.
- FE lock may not be effective if the subject is too small on the screen.

High-speed sync enables flash photography at even higher shutter speeds than the maximum flash sync shutter speed. This is effective when shooting with an open aperture in < **Av** > (aperture-priority AE) mode to blur the background behind subjects outdoors in daylight, for example.

1. Press <  >.

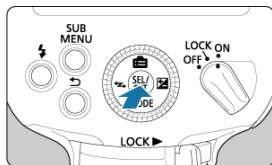

2. Select the option shown in (1).

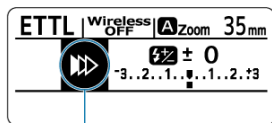



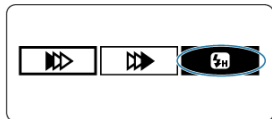

(1)

- Turn the <  > dial to select an option, then press <  >.

3. Select <  >.





- Turn the <  > dial to select <  >, then press <  >.
- Before shooting, confirm that <  > appears in the viewfinder.

 **Caution**

- With high-speed sync, the faster the shutter speed, the lower the guide number. You can check the effective flash range on the LCD panel.
- To avoid wearing out or damaging the flash head from overheating, the Speedlite may reduce the continuous flash count in repeated shooting with high-speed sync.

 **Note**

- <  > is not displayed in the viewfinder at shutter speeds slower than the maximum flash sync shutter speed.
- To return to normal flash firing, select <  > (first-curtain sync) in step 3 (<  > is not displayed on the screen after configuration).

Using second-curtain sync at low shutter speeds enables natural shots of subject motion trails, such as car lights. The flash fires immediately before the camera finishes shooting (before the shutter closes).

1. Press **< 0 >**.

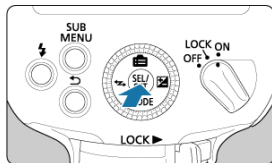

2. Select the option shown in (1).

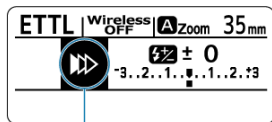

- Turn the **< 0 >** dial to select an option, then press **< 0 >**.

3. Select **< 0 >**.

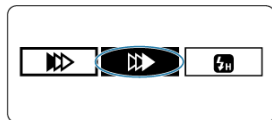

- Turn the **< 0 >** dial to select **< 0 >**, then press **< 0 >**.



Note

- Second-curtain sync works well in (Bulb) shooting mode.
- The Speedlite fires twice in <ETTL> flash mode. The first firing, which does not indicate malfunctioning, is preflash to determine flash output.
- To return to normal flash firing, select <▶▶> (first-curtain sync) in step 3 (<▶▶> is not displayed on the screen after configuration).

Bounce

[Catchlight Shooting](#)

[Shooting with a Bounce Adapter](#)

Pointing the flash head at a ceiling or wall to use the light reflected from it can soften subject shadows, enabling more natural-looking shots. This shooting method is referred to as bounce flash photography.

Setting the orientation of the flash head

- You can turn or tilt the flash head as shown. Turning or tilting the flash head changes the display to $\langle \text{---} \text{---} \text{---} \rangle$.
- With the Speedlite set to $\langle \mathbf{A} \rangle$ (Auto) flash coverage, turning the flash head sets flash coverage to 50 mm, and $\langle \text{---} \text{---} \text{---} \rangle$ is displayed.
- You can also set the flash coverage manually ().

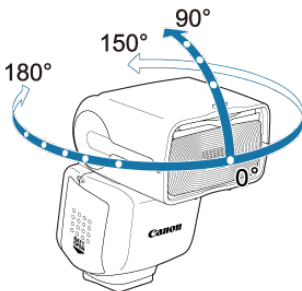

Note

- Bouncing light off ceilings or walls that are too far away may not provide sufficient exposure, because not enough light will reach the subject.
- If your shots are too dark, reduce the aperture value (f/number) to open the aperture and try again. You can also try increasing the ISO speed.
- Choose a plain white or off-white ceiling or wall to bounce the light off, because these are more reflective. Reflections off non-white surfaces may not provide sufficient exposure – not enough light may reach the subject, and your shots may be affected by the color of surface used.
- Using Quick flash in bounce flash photography is more likely to cause underexposure, from the reduced flash output.

Catchlight Shooting

Using the catchlight panel when shooting a portrait enables you to capture reflected light in a person's eyes and create a more vivid expression.

1. Tilt the flash head up 90°.

2. Pull up the wide panel.

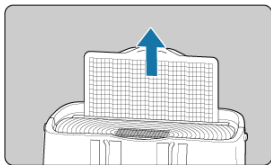

- Lift the tab in the middle of the wide panel.
- The white catchlight panel comes out with it.

3. Push back the wide panel.

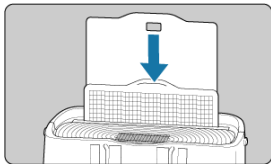

- Push back the wide panel by itself, leaving only the catchlight panel up.
- Shooting is the same as normal bounce flash photography.

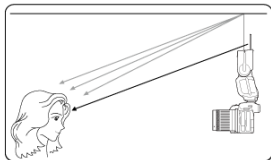

 **Caution**

- Position the flash head toward the front and 90° up. When the flash head is rotated to the left or right, the catchlight is not very effective.
- To effectively obtain the catchlight in a person's eyes, shoot within approx. 1.5 m / 4.9 ft. from the subject (at ISO 100 with f/2.8).
- Do not pull up the wide panel with excessive force. Doing so may detach the wide panel from the Speedlite.

Shooting with a Bounce Adapter

By attaching a bounce adapter (sold separately) to the Speedlite, the flash can be bounced off the ceiling, walls, etc. when shooting to diffuse it over a wider area for a softer flash and reduce subject shadows.

When the flash head is positioned at 90° to bounce off the ceiling, etc., diffused lighting from the side of the bounce adapter will hit the subject from the front (approximate shooting distance: within 1.5 m / 4.9 ft., at ISO 100 and f/2.8), further reducing subject shadows. When shooting people, this can also create catchlights.

1. Attach the bounce adapter.

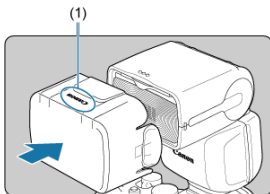

(1) Canon logo

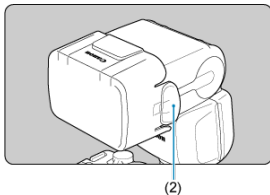

- Securely attach the adapter to the flash head as shown in the figure until you hear a "click."
- Make sure that the display shows $< \text{B} \text{M} >$.
- To remove the adapter, lift the left and right ejector tabs to release and remove the adapter from the flash head.

2. Take the picture.

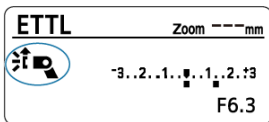

- Bounce off the ceiling, walls, etc. while shooting.

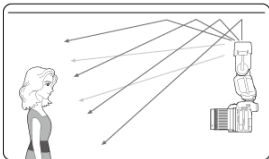

⚠ Caution

- When using a bounce adapter or a bounce adapter with a wide panel, the guide number will drop and underexposure is more likely. As necessary, raise the camera ISO speed or use flash exposure compensation (☑).
- As using Quick flash (☑) with a bounce adapter attached may result in insufficient flash output, in such cases it is recommended to wait for the flash-ready lamp to lit in red before shooting.
- Flash coverage is set automatically when a bounce adapter is attached. It cannot be changed manually.

📄 Note

- When used in conjunction with a wide panel (☑), lighting can soften even further.
- If the subject looks dark (underexposed) when checking the image taken, use flash exposure compensation (☑). With digital cameras, you can also try increasing the ISO speed.

[Wide Panel](#)

Flash coverage can be set automatically or manually. Set to < **A** > (Auto) for automatic adjustment of flash coverage to suit the focal length (shooting angle of view) of the attached lens and the size of the image sensor (). With < **M** > (Manual), you can manually set flash coverage in a range of 24–105 mm.

1. Press <  >.

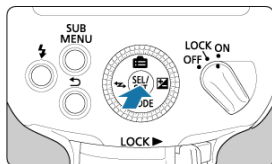

2. Select the option shown in (1).

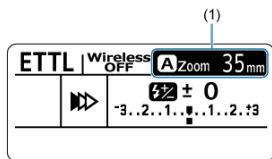

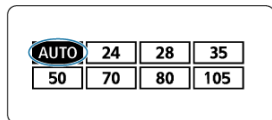

- Turn the <  > dial to select an option, then press <  >.



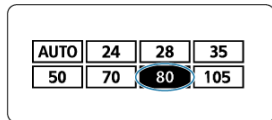
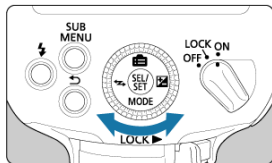

3. Set the flash coverage.



- Turn the <  > dial to select flash coverage, then press <  >.
- To set automatically, select < **AUTO** >, and to set manually, select a value (focal length in mm).

Note

- Flash coverage that you set manually should match or exceed the shooting angle of view, to avoid vignetting.
- A <  **WIDE** > warning is displayed on the LCD panel when a lens with a focal length less than 24 mm is attached. Similarly, a <  **WIDE** > warning is displayed when you are using a camera with an image sensor smaller than full-frame and the actual shooting angle of view exceeds that of a 24 mm lens.

Wide Panel

The built-in wide panel enables flash photography covering the angle of view of an ultra wide-angle lens with a focal length of 14 mm.

1. Pull out the wide panel.

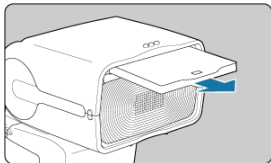

- Pull out the tab in the middle of the wide panel.
- The white catchlight panel comes out with it.

2. Push back the catchlight panel.

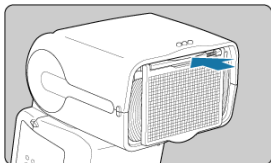

- Push back the catchlight panel by itself, leaving the wide panel down.

Caution

- A  **WP** > warning appears on the LCD panel when the wide panel is used in bounce flash photography, because underexposure is more likely to occur under these conditions.
- Do not pull out the wide panel with excessive force. This may detach it from the Speedlite.
- Not compatible with shooting angles of view from the EF15mm f/2.8 Fisheye or EF8-15mm f/4L Fisheye USM.

**Note**

- Flash coverage is set automatically when the wide panel is used. It cannot be changed manually.

[Setting Manual Flash Output from FE Memory](#)

[Metered Manual Flash Exposure](#)

Flash output can be set in a range of 1/1024 to full output (1/1), in 1/3-stop increments. By using a commercially available flash meter, you can determine the flash output required for suitable exposure. Setting the camera shooting mode to **<Av>** or **<M>** is recommended.

1. Press the **<MODE>** button on the **<⬅➡>** cross keys.

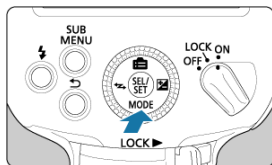

2. Set the flash mode to **<M>**.

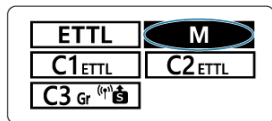

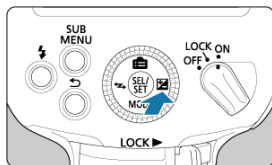

- Turn the **<⦿>** dial to select **<M>**, then press **<⦿>**.

3. Press the **<⌂>** button on the **<⬅➡>** cross keys.

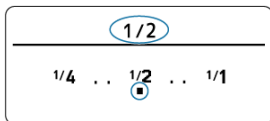

4. Set the flash output.





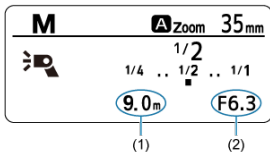

- Turn the <  > dial to select a flash output level, then press <  >.



- The approximate shooting distance (1) and the aperture value (2) are displayed when you press the camera shutter button halfway.

Note

- The flash output setting range is 1/128–1/1 when high-speed sync is set.
- If the flash output is set to 1/64, 1/80, 1/100, or 1/128 when high-speed sync is set, <  > will be displayed on the LCD panel, and the brightness may change during shooting. It is recommended to check your shots.
- For details on guide numbers when manual flash is used, see [Specifications](#).
- Flash output can be set directly without pressing the <  > button on the <  > cross keys by turning the <  > dial ([C.Fn-13](#)).

Setting Manual Flash Output from FE Memory

The flash output level used when shooting in <ETTL> flash mode can be applied as the level for <M> flash mode.

1. Set up the FE memory function.

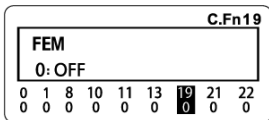

- In the custom functions, set C.Fn-19 <FEM> to [1] (ON,).

2. Shoot in <ETTL> flash mode.

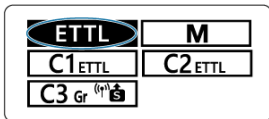

- Press the <MODE> button on the <⬆> cross keys.
- Turn the <⦿> dial to select <ETTL>, then press <⦿>.

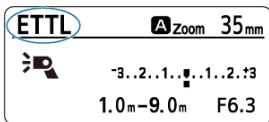

- Press the shutter button completely to shoot.

3. Set the flash mode to <M>.

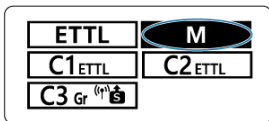

- Press the <MODE> button on the <⬅➡> cross keys.
- Turn the <⊙> dial to select <M>, then press <⊙>.

4. Check the flash output.

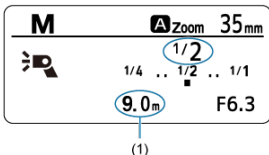

- Confirm that the subject is within the effective flash range (1).

⚠ Caution

- Before firing with the Speedlite set to <ETTL>, make sure the flash-ready lamp is red (fully charged).
- If you adjust the ISO speed, aperture value, or other settings that involve flash output (such as light intensity or flash zoom) after shooting with the Speedlite set to <ETTL>, we recommend shooting with it set to <ETTL> again.
- Color temperature of the Speedlite may differ greatly from that of the ambient light when the camera white balance is set to <AWB>, and color tones of shots may differ between <ETTL> and <M> settings when flash compensation is set to the negative side and [E-TTL balance] is set to [Ambience priority].
- When using FE memory in wireless flash photography, configure settings for <ETTL> and <M> firing groups identically in advance. When <ETTL> is set to <A:B:C>, set <M> to <A:B:C>.
- The effective flash range indicated for <ETTL> may not match the focus distance indicated for <M>, depending on shooting conditions.
- Setting flash output to 1/1024 may result in overexposure.



Note

- When C.Fn-19 <FEM> is set to [2] (ON / **MODE**ETTL↔M), you can switch between <ETTL> and <M> simply by pressing the <MODE> button on the <⬆⬇⬇⬆> cross keys.

Metered Manual Flash Exposure

Using a camera compatible with metered manual flash, you can set the flash exposure level manually before shooting. This is effective in close-range flash photography. Use a standard 18% gray reflector (commercially available) and shoot as follows.

1. Configure the camera and Speedlite settings.

- Set the camera shooting mode to **< M >** or **< Av >**.
- Set the Speedlite flash mode to **< M >**.

2. Focus on the subject.

- Focus on the subject manually.

3. Set up the 18% gray reflector.

- Place it at the position of the subject.
- Aim the camera so that the reflector fills the entire spot metering circle in the viewfinder.

4. Press the **< M-Fn >** or **< * >** / **< FEL >** button (ⓘ16).

- The Speedlite fires a preflash and stores the flash output required for suitable flash exposure.
- On the right side of the viewfinder, the exposure level indicator shows the flash exposure level relative to standard exposure.

5. Set the flash exposure level.

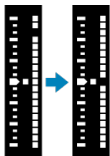

- Adjust the Speedlite's manual flash output to align the flash exposure level with the standard exposure index.

6. Take the picture.

- Remove the gray reflector and take the picture.



Note

- Refer to camera instruction manuals for details on cameras that are compatible with metered manual flash.

The flash fires continuously for approx. 1 sec. in response to pressing the DOF preview button on the camera when cameras other than models in the EOS R or EOS M series are used as a sender with the EL-10 as a receiver. This feature is referred to as modeling flash. It is useful for checking subject shadows created by the Speedlite, as well as the balance of lighting in wireless flash photography (📷).

1. Press the depth-of-field preview button on the camera.

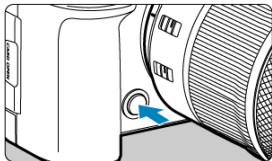

- The Speedlite fires continuously for approx. 1 sec.

⚠ Caution

- To avoid wearing out or damaging flash heads from overheating, do not fire the modeling flash more than 32 times. After firing the modeling flash 32 times, stop using the Speedlite for at least 35 min.
- After firing modeling flash this many times, further continuous firing at short intervals may activate a safety function that restricts firing. At a firing restriction level of 1, the firing interval is automatically set to approx. 8 sec. In this case, stop using the Speedlite for at least 35 min.

Color Filter

When shooting a tungsten light scene in flash photography, subject backgrounds that are out of flash range may have an unnatural reddish tint. By attaching a color filter (sold separately) to the flash, the camera's white balance feature can automatically compensate so that the subject and background can be shot in the appropriate white balance.

1. Attach the color filter.

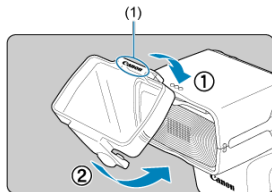

(1) Canon logo

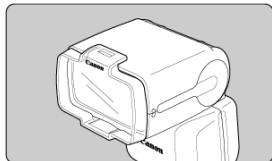

- Securely attach the filter to the flash head as shown in the figure until you hear a "click."
- Make sure that the display shows $\langle \text{WB} \text{ icon} \rangle$.
- To remove the filter, move in reverse order to lift the retaining tab on the underside of the filter and remove it from the flash head.

2. Take the picture.

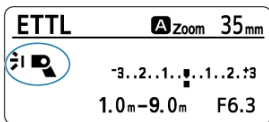

- Set the camera white balance to $\langle \text{⚡} \rangle$ and take the picture.
- White balance can also be set to $\langle \text{AWB} \rangle$ or $\langle \text{AWBW} \rangle$ to shoot.
- Check the image taken and compensate the white balance on the camera side as necessary.

! Caution

- When using a color filter, the guide number will be lowered. When using manual flash, compensate the flash output level by roughly +1 stop.
- Do not layer a commercially available color filter with the color filter sold separately.

📄 Note

- When attaching a color filter and using a wide-angle lens for flash photography, the ambient light intensity may decrease.
- If the color filter is dirty or dusty, wipe it off with a soft, dry cloth.
- A bounce adapter (📄) can also be attached when using a color filter.
- To create a tungsten light scene (slightly reddish ambiance), compensate the white balance to the amber side.

You can restore default settings for Speedlite shooting functions, wireless shooting, and Custom flash modes.

1. Press the **< SUB MENU >** button.

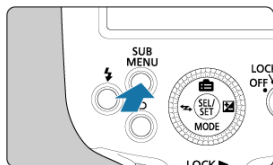

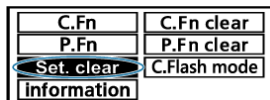

2. Select **< Set. clear >**.

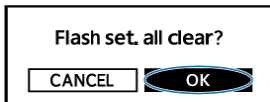
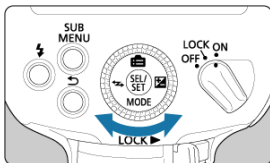

- Turn the **< (O) >** dial to select **< Set. clear >**, then press **< (●) >**.

3. Clear the settings.



- Turn the <  > dial to select < **OK** >, then press <  >.
- The Speedlite settings are cleared, preparing it for normal flash photography in < **ETTL** > flash mode.

Note

- Clearing the settings does not clear the radio channel or wireless radio ID for wireless flash photography, Custom/Personal Functions (C.Fn/P.Fn) settings, or Custom flash mode settings (except settings for auto updating and camera mode linkage).

Setting Flash Functions from the Camera

This chapter describes how to configure flash functions from the camera menu.

Caution

- Operations described in this chapter are not available when the camera is in Full Auto or Basic Zone modes. Set the camera's shooting mode to < **Fv** >, < **P** >, < **Tv** >, < **Av** >, < **M** >, or < **Bulb (B)** > (Creative Zone).

- [Flash Control from the Camera Menu](#)

Flash Control from the Camera Menu

[Flash Function Settings](#)

[Settings Available on the Flash Function Settings Screen](#)

[Flash C.Fn Settings](#)

You can set flash functions and Custom Functions from the camera menu. If Custom Functions on the Speedlite are not displayed on the camera, try updating the camera firmware, or set them from the Speedlite.

For camera instructions, refer to the camera instruction manual.

1. Press the  button on the  cross keys.

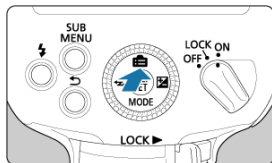

- A menu is displayed on the camera.

2. Set the function.

- The setting screen and options displayed vary depending on the camera.
- Select an option and set the function.

Example of display

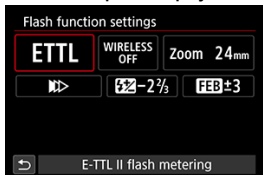

Settings Available on the Flash Function Settings Screen

On the camera's **[Flash function settings]** or **[External flash func. setting]** screen, you can configure settings for normal flash photography or radio transmission wireless flash photography.

Main functions you can configure are as follows. Available settings vary depending on flash mode, wireless function settings, and other conditions.

Function	
Flash firing	Enable / Disable
E-TTL balance	Ambience priority / Standard / Flash priority
E-TTL II meter.	Eval (FacePrty) / Evaluative / Average
Contin flash ctrl	E-TTL each shot / E-TTL 1st shot
Slow synchro	
Flash mode	E-TTL II flash metering (autoflash) / Manual flash
Wireless functions	Wireless:Off / Radio transmission
Flash zoom (flash coverage)	
Shutter synchronization	First-curtain synchronization / Second-curtain synchronization / High-speed synchronization
Flash exposure compensation	

● Flash firing

To enable flash photography, set to **[Enable]**. To enable only the AF-assist beam of the Speedlite, set to **[Disable]**.

● E-TTL balance

You can set your preferred appearance (balance) for flash shots. This setting enables you to adjust the ratio of ambient light to Speedlite light output.

● E-TTL II meter.

Set to **[Eval (FacePrty)]** for flash metering suitable for shots of people. High-speed continuous shooting is slower than when **[Evaluative]** or **[Average]** is selected. Set to **[Evaluative]** for flash metering that emphasizes firing in continuous shooting. If **[Average]** is set, flash exposure is averaged for the entire metered scene. Depending on the scene, flash exposure compensation may be necessary.

- **Contin flash ctrl**

Set to **[E-TTL each shot]** to perform flash metering for each shot. Set to **[E-TTL 1st shot]** to perform flash metering for only the first shot before continuous shooting. The flash output level for the first shot is applied to all subsequent shots. Useful when prioritizing continuous shooting speed without recomposing shots.

- **Slow synchro**

You can set the flash-sync speed for flash photography in **< Av >** (aperture-priority AE) mode.

- **Flash mode**

Select between **[E-TTL II flash metering]** and **[Manual flash]** to suit your desired flash photography.

- **Wireless functions**

You can set up radio transmission wireless flash photography. For details, see [Radio Transmission Wireless Flash Photography](#).

- **Flash zoom (flash coverage)**

You can set the Speedlite flash coverage. Set to **[Auto]** for automatic configuration of flash coverage to suit the lens focal length and image sensor size (🔗).

- **Shutter synchronization**

As the flash firing timing/method, you can choose from **[First-curtain synchronization]**, **[Second-curtain synchronization]**, or **[High-speed synchronization]**. For normal flash photography, set to **[First-curtain synchronization]**.

- **Flash exposure compensation**

Just as exposure compensation is adjusted, you can also adjust flash output. The amount of flash exposure compensation can be set in a range of ± 3 stops, in 1/3-stop increments.

- **Clear settings**

Select **[Clear flash settings]** or **[Clear external flash set.]** to restore Speedlite settings to defaults.

 **Caution**

- With a bounce adapter is attached, **[Flash zoom]** (flash coverage) is not available if flash coverage is automatically set, such as when using the wide panel.



Note

- Flash exposure compensation cannot be performed from the camera when it is set on the Speedlite. If both are set at the same time, the Speedlite setting takes precedence.

Flash C.Fn Settings

You can set Custom Functions for the Speedlite from the camera menu. The information displayed varies depending on the Speedlite used. For details on Custom Functions, see [Customization with Custom Functions](#).

1. Select [Flash C.Fn settings].

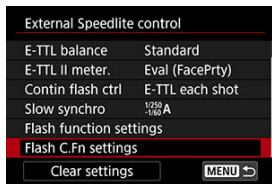

- Select [Flash C.Fn settings] or [External flash C.Fn setting].

2. Set the Custom Function.

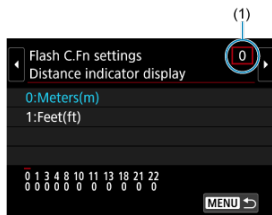

- Select the Custom Function number (1), then set the function.

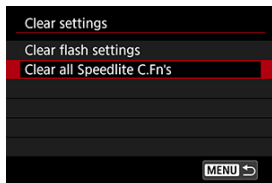

- To clear all the Custom Function settings, select [Clear settings] in step 1, then select [Clear all Speedlite C.Fn's] or [Clear ext. flash C.Fn set.].

 Caution

- Personal Functions ([P.Fn](#)) cannot be set or collectively cleared from the camera menu screen. Set them on the Speedlite.

Radio Transmission Wireless Flash Photography

This chapter describes radio transmission wireless flash photography using sender and receiver functionality.

For details on Speedlites compatible with this wireless flash photography, refer to the Supplemental Information ([🔗](#)).

Caution

- Operations described in this chapter are not available when the camera is in Full Auto or Basic Zone modes. Set the camera's shooting mode to < **Fv** >, < **P** >, < **Tv** >, < **Av** >, < **M** >, or < **Bulb (B)** > (Creative Zone).
- When it is important to maintain the wireless connection, do not operate the power switch or move parts such as the battery compartment cover. The wireless connection will be terminated.
- If the flash is placed close to a floor or wall, the flash output may become unstable. In this case, move the flash away from the floor or wall, or change the direction the flash is facing, before shooting.

Note

- The EL-10 attached to the camera is referred to as a "sender," and other Speedlites controlled wirelessly are referred to as "receivers."
- The EL-10 also supports remote release (remote shooting) from a receiver ([🔗](#)). For details, refer to the instruction manual of a Speedlite equipped with remote release functionality.

- [Radio Transmission Wireless Flash Photography](#)
- [Wireless Settings](#)
- [Autoflash with One Receiver](#)
- [Autoflash with Two Receiver Groups](#)
- [Autoflash with Three Receiver Groups](#)
- [Wireless Multiple-Flash Photography with Flash Ratio](#)
- [Shooting in Group-Specific Flash Modes](#)
- [Firing Test Flash/Modeling Flash from Receivers](#)
- [Remote Release from Receivers](#)
- [Linked Shooting](#)

Radio Transmission Wireless Flash Photography

- [Positioning and Range](#)
- [Group Control](#)
- [Restrictions for Specific Cameras](#)

Shooting with wireless lighting from multiple flash units is as easy as normal E-TTL II / E-TTL autoflash shooting when you use Canon Speedlites supporting radio transmission wireless flash photography.

The system is designed so that the settings of the EL-10 (sender) are automatically applied to wirelessly controlled Speedlites (receivers). This eliminates the need to operate receivers during shooting.

Positioning and Range

- Autoflash with one receiver (📷)

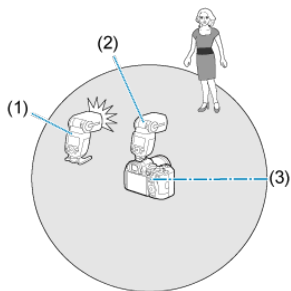

- (1) **RECEIVER** EL-10
- (2) **SENDER** EL-10
- (3) Transmission range: Approx. 30 m / 98.4 ft.

● **Autoflash with groups of receivers** (🔗, 📷)

E-TTL II / E-TTL autoflash photography is possible with two or three receiver groups, and the flash ratio (proportion of flash output) can be adjusted as needed.

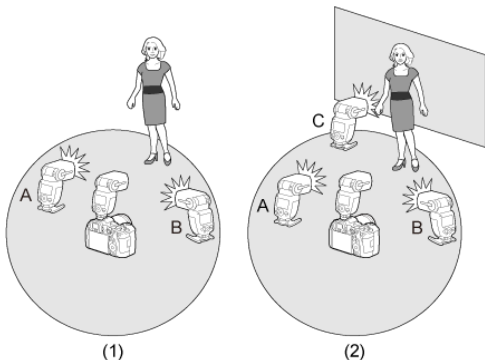

(1) 2 groups (A, B)

(2) 3 groups (A, B, C)

⚠ Caution

- Take a few test shots in advance, and test flash firing (📷).
- Transmission range may be shorter depending on factors such as Speedlite positioning, the surrounding environment, and weather conditions.

📄 Note

- Set up receivers using the included mini stand.

● Shooting in a different flash mode for each group (🔗)

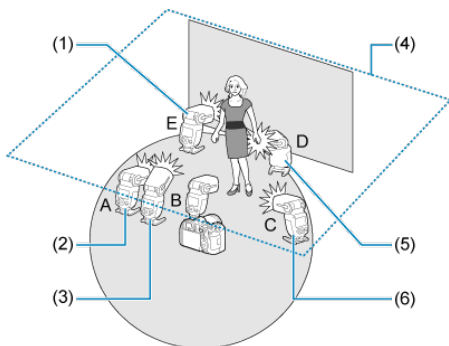

* This is only one example of flash mode settings.

- (1) E-TTL II
- (2) E-TTL II
- (3) Manual flash
- (4) Ceiling
- (5) Manual flash
- (6) Manual flash

Group Control

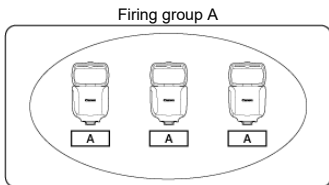

You can add receivers when more light or sophisticated lighting is needed. For added receivers, simply specify the firing group (A, B, or C) that you want to be brighter. For example, when three receivers are set to firing group < **A** >, they are all controlled as a single, high-output Speedlite in group A.

Caution

- To fire the three groups of A, B, and C, set to < **A:B:C** >. Group C does not fire when Speedlites are set to < **A:B** >.
- Aiming the units in firing group C directly at subjects may cause overexposure.

Note

- Flash ratios from 8:1 to 1:1 to 1:8 correspond to 3:1 to 1:1 to 1:3 (in 1/2-stop increments) as converted to number of stops.

Restrictions for Specific Cameras

Using a Speedlite other than the EL-10 as the sender may limit the functions available in radio transmission wireless flash photography. For details on available functions, refer to the instruction manual of the Speedlite used as the sender.

Wireless Settings



- [Setting as Sender](#)
- [Setting as Receiver](#)
- [Setting the Transmission Channel / Wireless Radio ID](#)
- [≤ LINK > Lamp and Connection Indicator](#)
- [Sender Flash Firing On / Off](#)

Set the sender and receiver for radio transmission wireless flash photography with E-TTL II / E-TTL autoflash as follows.



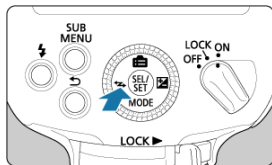

Setting as Sender

1. Press the  button on the  cross keys.

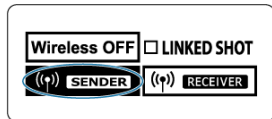







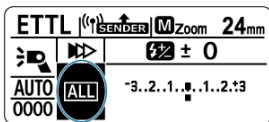

2. Set to  **SENDER** .



- Turn the  dial to select  **SENDER** , then press .

3. Select the firing method.



- Press <  >.
- Turn the <  > dial to select option (1), then press <  >.
- Turn the <  > dial to select from between <  >, <  >, and <  >, then press <  >.

Setting as Receiver

1. Set to < ((P)) **RECEIVER** >.

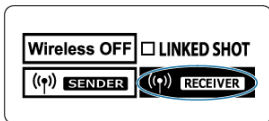

- Configure this setting on Speedlites to use as receivers.
- Select < ((P)) **RECEIVER** > just as you set up the sender.

⚠ Caution

- Before normal flash photography, select < **WIRELESS OFF** > to clear the wireless (sender/receiver) settings.

Setting the Transmission Channel / Wireless Radio ID

Set the sender's transmission channel and wireless radio ID as follows. **Set the same channel and ID for both the sender and receivers.** For receiver instructions, refer to the instruction manual of Speedlites equipped with radio transmission wireless receiver functionality.

Caution

- Set different wireless radio IDs for each channel, because interference between systems with Speedlites controlled by radio transmission may occur even if the units are set to different transmission channels.

1. Press <⊙>.

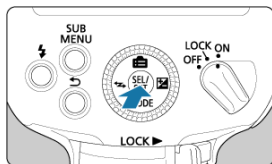

2. Select option (1).

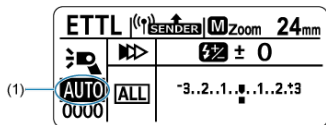

- Turn the <⊙> dial to select a channel option, then press <⊙>.



3. Set a transmission channel.

AUTO	1	2	3
4	5	6	7
8	9	10	11
12	13	14	15

- Turn the <  > dial to select < **AUTO** > or between Ch.1 to 15, then press <  >.

4. Select option (2).





(2) 

ETTL (↑) SENDER M Zoom 24mm	
	  ± 0
AUTO	ALL
0000	*3..2..1..*..1..2:*3

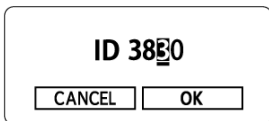
- Select the ID option just as you set the transmission channel, then press <  >.

5. Set the wireless radio ID.



- Turn the <  > dial to select the position (digit), then press the <  >.
- Turn the <  > dial to select a number between 0 and 9, then press <  >.
- Set a 4-digit number the same way, then select <  >.

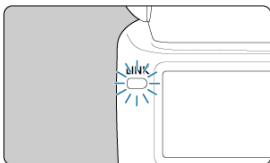

- The < **LINK** > lamp is lit in green when communication is established between the sender and receiver.

Scanning and setting sender transmission channels

You can scan radio signal conditions and then set the sender transmission channel automatically or manually. Setting the channel to [AUTO] will automatically reset the Speedlite to the channel with the strongest signal. When setting the channel manually, you can review scan results as you reset it.

● Scanning when currently set to [AUTO]

1. Press the **< SUB MENU >** button.

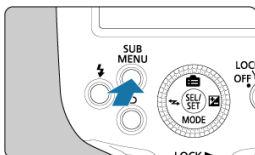

2. Run the scan.

C.Fn	C.Fn clear
P.Fn	P.Fn clear
Set. clear	C.Flash mode
Information	SCAN

- Turn the **< (DIAL) >** dial to select **< SCAN >**, then press **< (OK) >**.
- Select **< OK >**.
- The scan is performed, and the setting is reset to the channel with the strongest signal.

● Scanning when currently set to a channel (1–15)

1. Press the **< SUB MENU >** button.

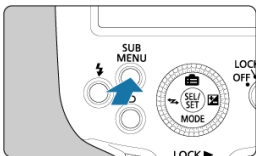

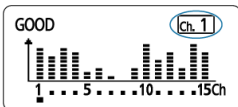

2. Run the scan.

- Turn the **< Ⓞ >** dial to select **< SCAN >**, then press **< Ⓞ >**.
- Select **< OK >**.
- The scan is performed, and a graph of signal conditions is displayed.
- Higher peaks in the graph indicate stronger signals.

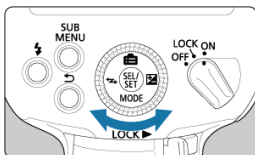

3. Set the channel.



- Turn the <  > dial to select between Ch.1 to 15.
- Press <  > to set the channel.

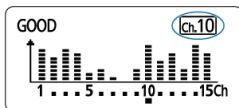

<LINK> Lamp and Connection Indicator

You can determine the connection status from the state of the <LINK> lamp or the icon on the LCD panel.

Status	Description	Action
Lit	Connected	—
Off	Not connected	Check the channel and ID
Off	Too many units	Do not exceed 16 senders and receivers, combined
Off	Error	Restart the senders and receivers
Lit	Connected* ¹	—
Lit	Connected* ²	—

* 1: When the sender side is connected to the sub-sender

* 2: When the sender side is connected for linked shooting

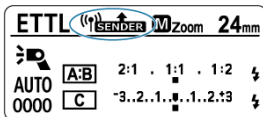

Display	Description	Action
	Connected	—
	Not connected	Check the channel and ID
	Too many units	Do not exceed 16 senders and receivers, combined
	Error	Restart the senders and receivers
	Connected* ¹	—

* 1: When the sender side is connected to the sub-sender

⚠ Caution

- Receivers do not fire unless the sender and receiver channels match. Set both to the same number, or set both to [AUTO].
- Receivers do not fire unless the sender and receiver wireless radio IDs match. Set to the same number.

Sender Flash Firing On / Off

You can set whether the sender fires along with the receivers it controls wirelessly. When sender flash firing is enabled, the sender fires as firing group A.

1. Press <⊙>.

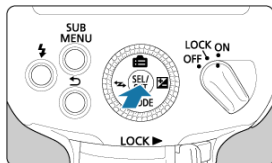

2. Select the option shown in (1).

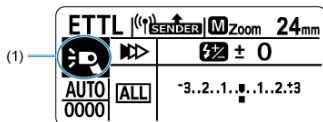

- Turn the <⊙> dial to select an option, then press <⊙>.

3. Set sender flash firing.

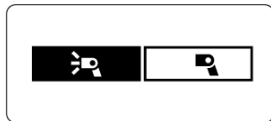

- Turn the <⊙> dial to turn sender flash firing ON/OFF, then press <⊙>.
 - <⚡📷>: Sender flash firing ON
 - <📷⚡>: Sender flash firing OFF



Note

- Disabling sender flash firing expands the available flash output range from 1/1024 to 1/8192.

Autoflash with One Receiver

- [LCD Panel Illumination](#)
- [Flash Photography Applying Wireless Features](#)
- [Using Multiple Senders](#)

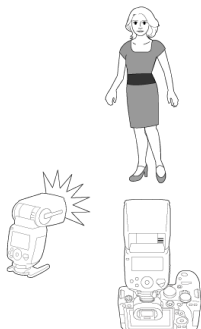

This section describes basic fully automatic wireless shooting with an EL-10 attached to the camera as a sender and an EL-10 set as a receiver.

1. Set up a unit as the sender.

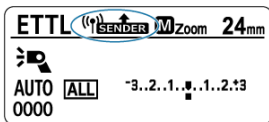

- Set the EL-10 attached to the camera as a sender ().
- You can also use other devices equipped with radio transmission wireless sender functionality as senders.

2. Set up a unit as the receiver.

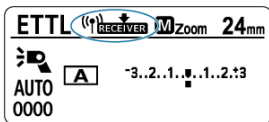

- Set the EL-10 for wireless control by the sender as the receiver (🔗).
- You can also use other Speedlites equipped with radio transmission wireless receiver functionality.

3. Check the channel and ID.

- Set the same transmission channel and wireless radio ID on senders and receivers, if they are different (🔗).

4. Position the camera and other Speedlite.

- Position them within the range shown in [Positioning and Range](#).

5. Press the <MODE> button on the sender <⬅➡> cross keys.

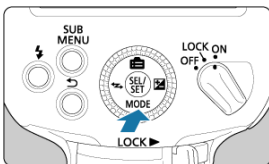

6. Set the flash mode to <ETTL>.

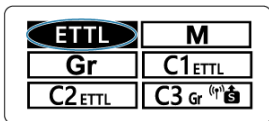

- Turn the < > dial to select < **ETTL** >, then press < >.
- The receiver is automatically set to < **ETTL** > during shooting, as controlled by the sender.
- Confirm that firing group control is set to < **ALL** >.

7. Check the connection and make sure the flash units are charged.

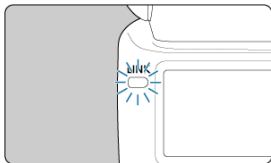

- Confirm that the < **LINK** > lamp is lit in green.

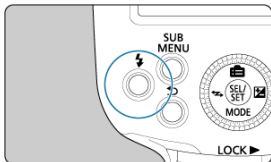

- Confirm that the sender and receiver flash-ready lamps are lit.

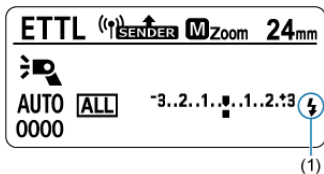

- Confirm that the < **⚡** > icon (1) indicating completion of sender/receiver charging appears on the sender LCD panel (< **CHARGE** > is not displayed).
- For details on sender LCD panel illumination, see [LCD Panel Illumination](#).

8. Check operation.

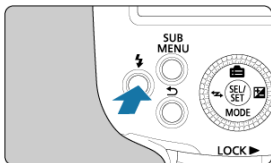

- Press the sender test flash button.
- The Speedlites fire. If it does not fire, confirm that it is within transmission range (📶).

9. Take the picture.

- Just as in normal flash photography, shoot after configuring the camera.

⚠ Caution

- Radio transmission is not possible unless the **<LINK>** lamp is lit. Double-check the transmission channels and wireless radio IDs of senders and receivers. If you cannot connect with the same settings, restart the senders and receivers.

📷 Note

- Flash coverage of the sender and receiver is set to 24 mm. You can also set the flash coverage manually.
- The sender can also fire (📶).
- You can fire the modeling flash by pressing the camera's depth-of-field preview button when an EL-10 is set as a receiver (📶). Modeling flash cannot be fired this way when an EL-10 is set as a sender.
- Auto power off takes effect in approx. 5 min. when the Speedlite is set as a sender.
- To turn on a receiver that is in auto power off mode, press the sender test flash button.
- Test flash firing is not available while a camera's flash timer or similar functions are active.
- You can change the time until auto power off takes effect on a receiver in [C.Fn-10](#).

LCD Panel Illumination

In radio transmission wireless flash photography, the sender LCD panel is on or off depending on whether senders and receivers (firing groups) are charged.

The sender LCD panel is lit when the sender and receiver are not fully charged. LCD panel illumination turns off approx. 12 sec. after senders and receivers are fully charged.



The sender LCD panel is lit again when sender and receiver charging resumes as you take pictures.

Caution

- < **CHARGE** > is displayed on the sender LCD panel as long as the sender or any receiver (firing groups) is not fully charged. Before shooting, confirm that < **CHARGE** > is not displayed on the LCD panel.

Flash Photography Applying Wireless Features

The wireless system eliminates the need to set up the following features on receivers, which are automatically configured based on sender settings. This enables wireless flash photography much like normal flash photography.

- [Flash Exposure Compensation](#) <  >
- [FE Lock](#)
- [High-Speed Sync](#) <  >
- [Second-Curtain Sync](#) <  >
- [Manual Flash](#)
 - [Wireless Multiple-Flash Photography with Flash Ratio](#)



Note

- You can also set flash exposure compensation and flash coverage manually on each receiver.
- With an EL-10 set as sender, radio transmission wireless second-curtain sync shooting is possible with other Canon Speedlites set as receivers. For details on compatible Speedlites, refer to the Supplemental Information ().

Using Multiple Senders

Multiple devices can be set as senders. Wireless flash photography under the same lighting arrangement (with the same receivers) is also possible using other cameras, by switching the camera that the sender is attached to.

< **SUB SENDER** > is displayed on the LCD panel when multiple senders are used.

Caution

- < **LINK** > lamps that are off or <  **SENDER** > display on LCD panels indicates that the Speedlites are not connected. After checking the transmission channel and wireless radio ID, restart each sender.
- Do not exceed a total of 16 senders and receivers in radio transmission wireless flash photography.

Note

- Flash photography is possible even when the sender is a sub-sender.

Autoflash with Two Receiver Groups

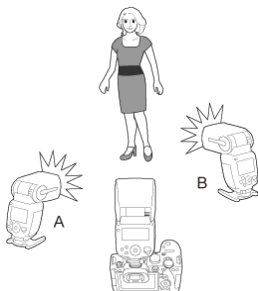

Receivers can be divided into firing groups A and B, and you can adjust the lighting balance (flash ratio) between them.

Exposure is automatically controlled, so that the groups' combined output provides standard exposure.

1. Press < >.

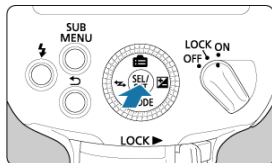

- Complete these settings on each receiver.

2. Set the receiver firing group in (1).

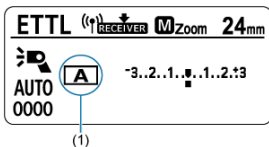

- Select either < A > or < B > for the firing group.
- Set one receiver to < A > and another to < B >.

3. Set the sender firing group in (2).

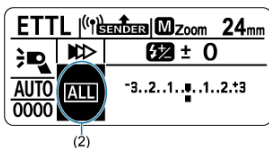

- Complete steps 3–5 on the sender.
- Turn the < ⓪ > dial to select an option, then press < ● >.

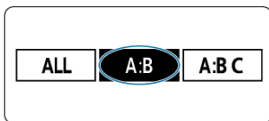

4. Set to < A:B >.

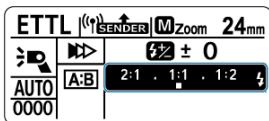

- Turn the < ⓪ > dial to select < A:B >, then press < ● >.

5. Set the A:B flash ratio.



- Press <  > to select the option shown in the figure.
- Turn the <  > dial to select the A:B flash ratio, then press <  >.

6. Check the connection and make sure the flash units are charged.

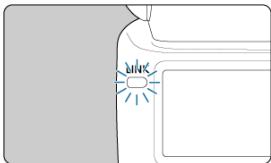

- Confirm that the < **LINK** > lamp is lit in green.

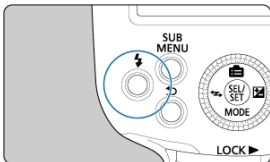

- Confirm that the sender and receiver flash-ready lamps are lit.

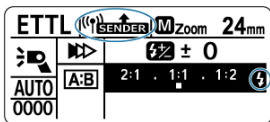

- Make sure < **SENDER** > is not displayed on the sender LCD panel.
- Confirm that the < **CHARGE** > icon indicating completion of sender/receiver charging appears on the sender LCD panel (< **SENDER** > is not displayed).
- For details on sender LCD panel illumination, see [LCD Panel Illumination](#).

7. Take the picture.

- The receivers fire at the flash ratio you have set.

Autoflash with Three Receiver Groups

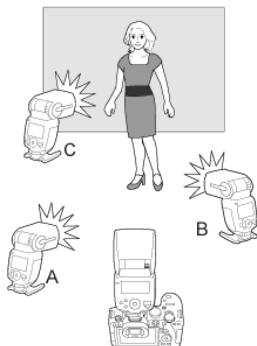

Once firing groups A and B have been set up, you can fire with multiple Speedlites by adding group C. For an overview of flash control, see [Group Control](#). Group C is useful when you want to eliminate shadows in the background behind subjects.

1. Press **<●>**.

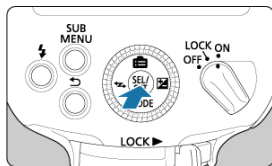



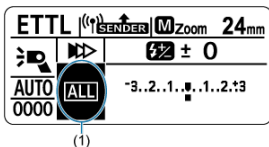

2. Select the option shown in (1).

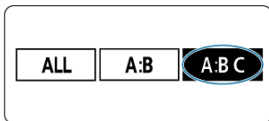

- Turn the <  > dial to select an option, then press <  >.

3. Set to <  >.



- Turn the <  > dial to select <  >, then press <  >.

4. Add Speedlites to firing group A, B, or C and position them.



- Confirm that all receivers and the sender are set to the same transmission channel and wireless radio ID.
- Set up receivers for group A, B, or C and position them.

5. Check the channel and ID.

- Set the same transmission channel and wireless radio ID on senders and receivers, if they are different ().

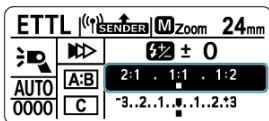

6. Set the A:B flash ratio.

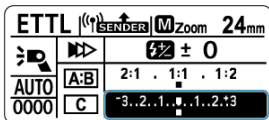

- Press <  > to select the option shown in the figure.
- Turn the <  > dial to select the A:B flash ratio, then press <  >.

7. Set the flash exposure compensation amount for firing group C.



- Press <  > to select the option shown in the figure.
- Turn the <  > dial to select an exposure compensation amount, then press <  >.

8. Check the connection and make sure the flash units are charged.

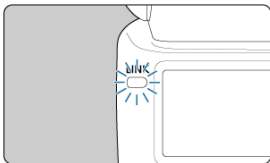

- Confirm that the < **LINK** > lamp is lit in green.

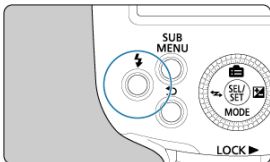

- Confirm that the sender and receiver flash-ready lamps are lit.

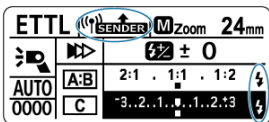

- Make sure < **SENDER** > is not displayed on the sender LCD panel.
- Confirm that the < **⚡** > icon indicating completion of sender/receiver charging appears on the sender LCD panel (< **CHARGE** > is not displayed).
- For details on sender LCD panel illumination, see [LCD Panel Illumination](#).

9. Check operation.

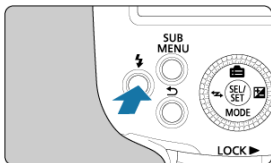

- Press the test flash button on the sender.
- The Speedlites fire. If they do not fire, confirm that they are within transmission range (📶).

10. Take the picture.

- Just as in normal flash photography, shoot after configuring the camera.

⚠ Caution

- Radio transmission is not possible when $\langle \text{SENDER} \rangle$ is displayed on the LCD panel. Double-check the transmission channels and wireless radio IDs of senders and receivers. If you cannot connect with the same settings, restart the senders and receivers.
- Aiming the units in firing group C directly at the main subject may cause overexposure.

📄 Note

- You can fire the modeling flash by pressing the camera's depth-of-field preview button (📷).
- Auto power off takes effect in approx. 5 min. when the Speedlite is set as a sender.
- To turn on a receiver that is in auto power off mode, press the sender test flash button.
- Test flash firing is not available while a camera's flash timer or similar functions are active.

Wireless Multiple-Flash Photography with Flash Ratio

This section describes wireless multiple-flash shooting in manual flash mode. For each firing group, you can set flash output in a range from full 1/1 output to 1/1024 output, in 1/3-stop increments. All settings are configured on the sender.

1. Press the **<MODE>** button on the **<⇄>** cross keys.

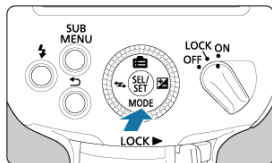

2. Set the flash mode to **<M>**.

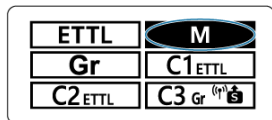

- Turn the **<⦿>** dial to select **<M>**, then press **<⦿>**.

3. Press **<⦿>**.

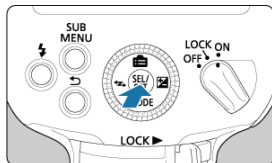

4. Select the option shown in (1).

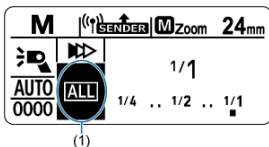

- Turn the <⊙> dial to select an option, then press <⊙>.

5. Configure the firing group setting.

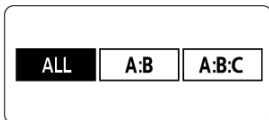

- Turn the <⊙> dial to select the firing method from the following options. This enables wireless multiple-flash photography with firing groups A–C added.
 - For the same output from all receivers, select <ALL>.
 - To set the output for firing groups A and B, select <A:B>.
 - To set the output for firing groups A, B, and C, select <A:B:C>.

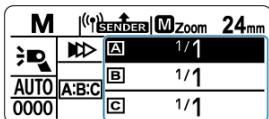

6. Select a firing group.

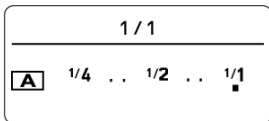

- If <A:B> or <A:B:C> is selected in step 5, press <⊙> and turn the <⊙> dial to select a group for which to set the flash output.

7. Set the flash output.



- Press <  >.
- Turn the <  > dial to select a flash output level, then press <  >.
- Repeat steps 6–7 to set flash output for all groups.



8. Take the picture.

- Each group fires at the specified flash output.

Caution

- The setting range is 1/128–1/1 when high-speed sync is set.
- Speedlites other than the EL-10 used as receivers may not display low flash firing levels correctly.

Note

- When <  > is set, set A, B, or C as the firing group for receivers. They will not fire when set to D or E.
- To fire multiple receivers at the same flash output, select <  > in step 5.

Shooting in Group-Specific Flash Modes

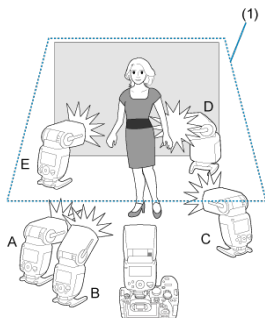

(1) Ceiling

For up to five groups (A–E), you can shoot with each group set to a specific flash mode. Available flash modes include (1) E-TTL II / E-TTL autoflash, (2) manual flash, and (3) auto external flash metering. When the flash mode is (1) or (3), exposure is controlled to result in standard exposure for the main subject as a single group. This function is for advanced users who are very knowledgeable and experienced in lighting.

1. Press the **<MODE>** button on the sender <⬅➡> cross keys.

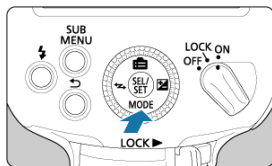

2. Set the flash mode to <Gr>.

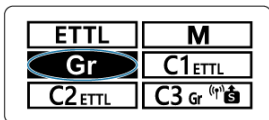

- Turn the < > dial to select < **Gr** >, then press < >.
- The receiver flash mode is set automatically during shooting, as controlled by the sender.

3. Set the firing groups of the receivers.

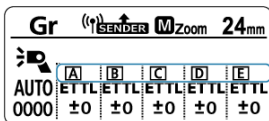

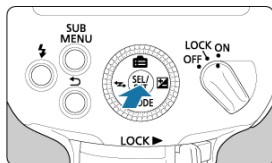

- Set a firing group (A–E) for each receiver.

4. Configure each firing group.

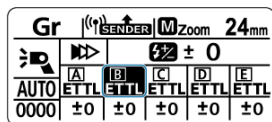

- On the sender, set the flash mode of each firing group.
- Press <  >.



- Turn the <  > dial to select a firing group, then press <  >.

Setting the flash mode



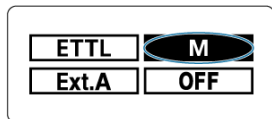



A	ETTL	±0
B	ETTL	±0
C	ETTL	±0
D	ETTL	±0
E	ETTL	±0

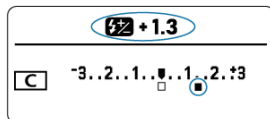
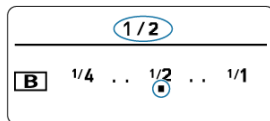

- Turn the <  > dial to select the flash mode from < **ETTL** >, < **M** >, or < **Ext.A** >.

Setting the flash output and flash exposure compensation amount



- Turn the <  > dial to select an option, then press <  >.
- Turn the <  > dial to adjust flash output or flash exposure compensation, then press <  >.
- For < **M** >, set the flash output level. For < **ETTL** > or < **Ext.A** >, set the flash exposure compensation amount as needed.
- Repeat step 4 to configure flash features for all firing groups.
- By setting P.Fn-04 to [1] (), you can change this setting simply by turning the <  > dial.

5. Before shooting, confirm that flash recharging is finished.

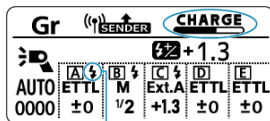

(1)

- When < **CHARGE** > is displayed, you can determine which firing groups are not fully charged from the icons. For example, the icon shown in (1) indicates that firing group < **A** > is fully charged.
- < **CHARGE** > is no longer displayed after all groups are fully charged.
- For other details on checking recharge status, see step 7 in [Autoflash with One Receiver](#).
- Each receiver fires at the same time in the flash mode you have set.

 **Caution**

- For < **Ext.A** > flash mode, make sure the receivers support auto external flash metering. Receivers will not fire unless it is supported.
- In < **ETTL** > or < **Ext.A** > flash mode, exposure is controlled to obtain standard exposure for the main subject as if using a single firing group, which may cause overexposure if multiple firing groups are pointing toward the main subject.

 **Note**

- For details on < **Ext.A** >, refer to the instruction manual of Speedlites that support auto external flash metering.
- Letters of groups that fire do not need to be in consecutive alphabetical order; for example, A, C, E can be set.
- Set any group you do not wish to fire to < **OFF** > when configuring flash modes in step 4.

Firing Test Flash/Modeling Flash from Receivers

Test flash or modeling flash (📡) can be fired in radio transmission wireless flash photography from EL-10 Speedlites set as receivers.

1. Press <⊙>.

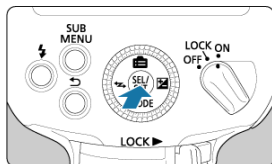

2. Fire the flash.

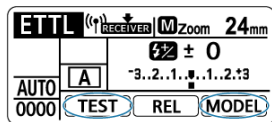

[Test flash firing]

- Turn the <⊙> dial to select < **TEST** >, then press <⊙>.

[Modeling flash] (📡)

Available when cameras other than models in the EOS R or EOS M series are used as a sender with the EL-10 as a receiver.

- Turn the <⊙> dial to select < **MODEL** >, then press <⊙>.
- The wireless system fires test or modeling flash after the receiver transmits a firing signal to the sender.

⚠ Caution

- For precautions on modeling flash, see [Modeling Flash](#).



Note

- When there are multiple senders () , the firing signal is transmitted to the main sender.

Remote Release from Receivers

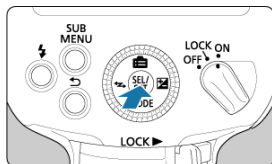

EL-10 Speedlites set as receivers can be used to shoot remotely in radio transmission wireless flash photography, enabling remote control shooting.

1. Press <  >.

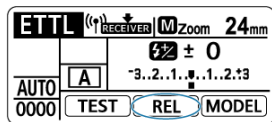

2. Take the picture.



- Turn the <  > dial to select < **REL** >, then press <  >.
- The sender shoots after the receiver transmits a firing signal to it.

Caution

- Shooting is not possible unless the camera can focus on subjects with AF. Consider setting the lens focus mode switch to < **MF** > and focusing manually before remote release.

Note

- The camera shoots in single shooting mode regardless of the current drive mode setting.
- When there are multiple senders () , the firing signal is transmitted to the main sender.
- < **RELEASE** > is displayed on the sender LCD panel during remote release from receivers.

Linked Shooting

Linked shooting is supported, in which shooting with the sender camera automatically triggers shutter release by receiver cameras. You can perform linked shooting with up to 16 sender and receiver cameras in all. This is useful when shooting a subject from multiple angles at the same time.

For linked shooting, attach Speedlites or Speedlite Transmitters that support radio transmission wireless flash photography to the cameras.

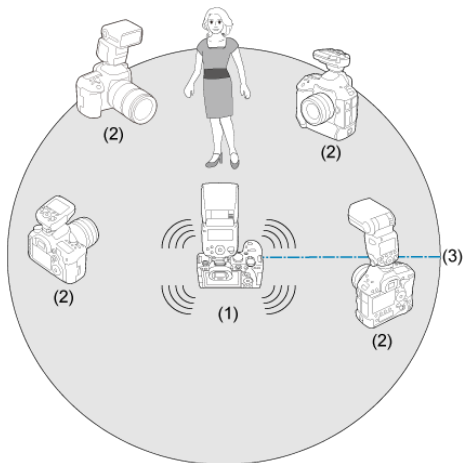

(1) Sender camera

(2) Receiver cameras

(3) Transmission range: Approx. 30 m / 98.4 ft.

Note

- For convenience in this guide, the EL-10 and the other cameras set up for linked shooting are referred to as the "sender camera" and "receiver cameras," respectively.

Caution

- Shooting is not simultaneous, because receiver cameras shoot slightly after the sender camera.

Before following these steps, attach a Speedlite or transmitter to all cameras you will use in linked shooting. For instructions on setting up other devices, refer to the instruction manuals of the devices.

1. Press the  button on the  cross keys.

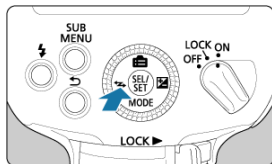

2. Set to LINKED SHOT >.

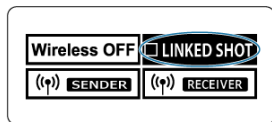

- Turn the  dial to select LINKED SHOT >, then press .

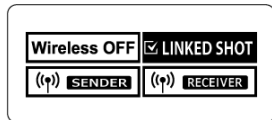

- Display then changes to LINKED SHOT >.

3. Set as a sender or receiver.

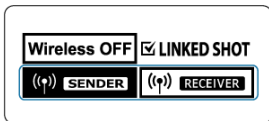

- Turn the <⊙> dial to select <⊙> **SENDER** > or <⊙> **RECEIVER** >, then press <⊙>.

4. Press <⊙>.

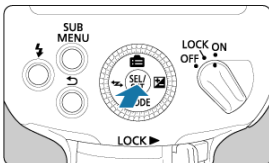

5. Select the option shown in (1).

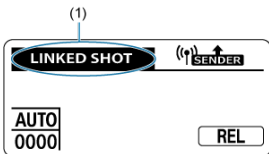

- Turn the <⊙> dial to select an option, then press <⊙>.

6. Set the flash mode.

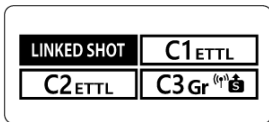

- Turn the < > dial to select a flash mode, then press < >.
- Descriptions next to < **C1** >–< **C3** > vary depending on the registered settings.
- For details on Custom flash modes, see [Custom Flash Modes](#).

7. Set the transmission channel and wireless radio ID.

- For instructions, see [Setting the Transmission Channel / Wireless Radio ID](#).

8. Set up shooting on the camera.

9. Set up all Speedlites.

- In the linked shooting setting, set up all Speedlites you will use in linked shooting as senders or receivers.
- Do the same for any transmitters you will use.
- Changing a Speedlite from receiver to sender in step 3 automatically changes other Speedlites (or transmitters) that were set as senders to receivers.

10. Position the receiver cameras.

- Position all receiver cameras within approx. 30 m / 98.4 ft. of the sender camera.
- Confirm that the < **LINK** > lamp of receivers is lit in green.

11. Take the picture.

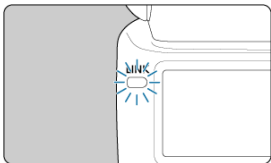

- Before shooting, confirm that the sender's **<LINK>** lamp is lit in green.
- Shooting with the sender camera automatically activates shooting by receiver cameras.
- **<RELEASE>** appears on the LCD panel of receivers that were used in linked shooting.

Note

- To cancel linked shooting, change the setting in step 2 to **<□ LINKED SHOT >** on each Speedlite.
- This feature can be used for remote control of linked shooting even without attaching the sender Speedlite to a camera. Press **<⊙ >** for the sender and select **<REL >** to release all receiver cameras.
- Auto power off takes effect in approx. 5 min. in linked shooting, for both senders and receivers. If more time than this will pass between shots in linked shooting, set auto power off to [OFF] on both senders and receivers ([C.Fn-01-1](#)).

Caution

- Consider setting the lens focus mode switch to **<MF >** on receiver cameras and focusing manually before linked shooting. Receiver cameras cannot shoot in linked shooting unless they can focus on subjects with AF.
- Flash can be fired in linked shooting when P.Fn-03 is set to [1] () , but if multiple Speedlites fire together, it may prevent suitable exposure or cause uneven exposure.
- Transmission range may be shorter depending on factors such as Speedlite positioning, the surrounding environment, and weather conditions.
- This linked shooting is equivalent to linked shooting with the WFT series of wireless file transmitters. However, WFT series transmitters cannot be used in this linked shooting. Also note that the shutter-release time lag differs from that of the WFT series.

Customizing the Speedlite

This chapter describes how to customize the Speedlite with Custom/Personal Functions (C.Fn/P.Fn).

Caution

- Operations described in this chapter are not available when the Speedlite is attached to a camera in Full Auto or Basic Zone modes. Set the camera's shooting mode to < **Fv** >, < **P** >, < **Tv** >, < **Av** >, < **M** >, or < **Bulb (B)** > (Creative Zone).

- [Setting Custom and Personal Functions](#)
- [Customization with Custom Functions](#)
- [Customization with Personal Functions](#)
- [Custom Flash Modes](#)

Setting Custom and Personal Functions

[C.Fn: Custom Functions](#)

[P.Fn: Personal Functions](#)

[Custom Function List](#)

[Personal Function List](#)

[Clearing All Custom/Personal Functions](#)

You can customize Speedlite functions to suit your shooting preferences. The functions for this purpose are called Custom Functions and Personal Functions. Personal Functions also enable customization specifically for the EL-10.

C.Fn: Custom Functions

1. Press the **< SUB MENU >** button.

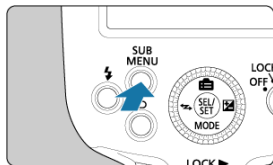

2. Display the Custom Functions screen.

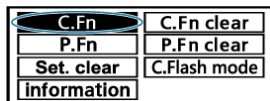

- Turn the **< SEL/SET >** dial to select **< C.Fn >**, then press **< SEL/SET >**.

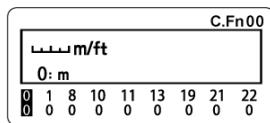

- The Custom Functions screen is displayed.



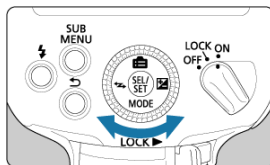

3. Select an option to set.

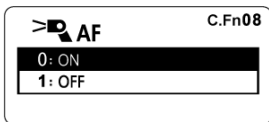

- Turn the **< SEL/SET >** dial to select an option (number) to set.

4. Change the setting.



- Press <  >.
- Turn the <  > dial to select the desired option, then press <  >.
- Press the <  > button to exit the settings.

1. Press the **< SUB MENU >** button.

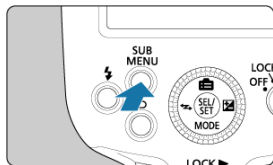

2. Display the Personal Functions screen.

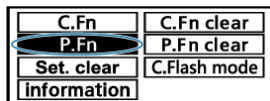





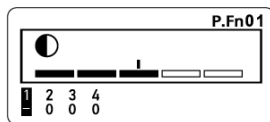



- Select **< P.Fn >** as in step 2 for Custom Functions, then press **< OK >**.

3. Set the function.







- Set Personal Functions as in steps 3–4 for Custom Functions.

Custom Function List

Number	Item	
C.Fn-00		Distance indicator display
C.Fn-01		Auto power off
C.Fn-08		AF-assist beam firing
C.Fn-10		Receiver auto power off timer
C.Fn-11		Receiver auto power off cancel
C.Fn-13		Flash exposure compensation setting
C.Fn-19		FE memory
C.Fn-21		Light distribution
C.Fn-22		LCD panel illumination

Personal Function List

Number	Item	
P.Fn-01	<  >	LCD panel density
P.Fn-02	<  QUICK >	Quick flash
P.Fn-03	<  LINKED SHOT >	Flash firing during linked shooting
P.Fn-04	<  DIRECT >	Change settings with dial

Clearing All Custom/Personal Functions

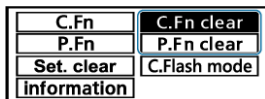

Select < **C.Fn clear** > or < **P.Fn clear** > on the screen shown above, then select < **OK** > to clear all custom functions or personal functions.

Caution

- Clearing all Custom Functions will not clear C.Fn-00.

Note

- You can also set or clear Speedlite Custom Functions from the camera menu .
- All Custom/Personal Functions registered in < **C1** >, < **C2** >, and < **C3** > Custom flash mode are cleared.

Customization with Custom Functions

C.Fn-00: m/ft (Distance indicator display)

You can select meters or feet for the distance indicator display on the LCD panel.



- **0: m (Meters (m))**
- **1: ft (Feet (ft))**

C.Fn-01: (Auto power off)

To conserve power, the Speedlite turns off automatically if left idle for approx. 90 sec., but this function can be disabled.

- **0: ON**
- **1: OFF**

Note

- Auto power off takes effect in approx. 5 min. when the Speedlite is set as a sender in radio transmission wireless flash photography () or configured for linked shooting ()
- When attached to a camera, the Speedlite turns off automatically if left idle for approx. 90 sec. after the camera power is turned off.
- Setting [**Auto power off**] on the camera to [**Disable**] also disables it on the Speedlite.

C.Fn-08: AF (AF-assist beam firing)

- **0: ON (Enabled)**
- **1: OFF (Disabled)**
Disables the Speedlite's AF-assist beam.

C.Fn-10: (Receiver auto power off timer)

You can change the time until auto power off takes effect when the Speedlite is set as a receiver in radio transmission wireless flash photography. < > is displayed on the LCD panel when the receiver enters auto power off mode. Set this function for each receiver.



- 0: 60 min.
- 1: 10 min.



C.Fn-11: (Receiver auto power off cancel)

Receivers that have entered auto power off mode in radio transmission wireless flash photography can be turned on by pressing the sender test flash button. You can change the time allowed for receivers in auto power off mode to accept this signal. Set this function for each receiver.

- 0: 8 h (within 8 hr.)
- 1: 1 h (within 1 hr.)

C.Fn-13: (Flash exposure compensation setting)

- 0:  +  (button + dial)
- 1:  (Direct setting with dial)





Flash exposure compensation and flash output can be set directly without pressing the < > button on the < > cross keys by turning the < > dial.

C.Fn-19: FEM (FE memory)

You can select whether to update, based on E TTL flash output, the flash output maintained in manual mode.





- **0: OFF**
- **1: ON**
- **2: ON / **MODE**E TTL ↔ M**

Note

- C.Fn-19 is set to [2], modes other than < **E TTL** > and < **M** > cannot be selected when pressing the < **MODE** > button on the <  > cross keys. To select a different mode, press <  > to display the setting screen, turn the <  > dial to select an option, and select a mode.
- If C.Fn-19: (FE memory) is changed or clear all is selected on the camera menu [ **External Speedlite control**], check whether the camera being used supports C.Fn-19: (FE memory).

C.Fn-21: (Light distribution)

You can change the Speedlite's light distribution (flash coverage) characteristics relative to the shooting angle of view when flash coverage is set to < **A** > (Auto).

- **0:  (Standard)**
Optimal flash coverage for the shooting angle of view is set automatically.
- **1:  (Guide number priority)**
Effective when prioritizing flash output, although image edges are slightly darker than when set to [0]. Flash coverage is automatically set slightly more toward the telephoto end than the actual shooting angle of view. The display changes to <  >.
- **2:  (Light distribution priority)**
Effective when minimizing vignetting, although the flash range is slightly shorter than when set to [0]. Flash coverage is automatically set slightly more toward the wide-angle end than the actual shooting angle of view. The display changes to <  >.

C.Fn-22: (LCD panel illumination)

The LCD panel is illuminated in response to button or dial operations. You can change this illumination setting.

- **0: 12 sec. (illuminated for 12 sec.)**
- **1: OFF (Disable panel illumination)**
- **2: ON (stays on)**

Customization with Personal Functions

P.Fn-01: (LCD panel density)

Density for the LCD panel can be adjusted in 5 steps.

P.Fn-02: QUICK (Quick flash)

You can set whether to fire the flash (Quick flash) when the flash-ready lamp is still blinking in red (before fully charged), so there is less time to wait for recharging.

- **0: ON (Enabled)**
- **1: OFF (Disabled)**

Caution

- Using Quick flash in continuous shooting () may cause underexposure, due to the reduced flash output.

P.Fn-03: LINKED SHOT (Flash firing during linked shooting)



You can set whether to fire the Speedlite attached to the camera in linked shooting (). Set for each Speedlite used in linked shooting.

- **0: OFF (Disabled)**
The Speedlite does not fire during linked shooting.
- **1: ON (Enabled)**
The Speedlite fires during linked shooting.

Caution

- Firing multiple Speedlites together in linked shooting may prevent suitable exposure or cause uneven exposure.

P.Fn-04: DIRECT (Change settings with dial)

You can select whether to allow direct configuration of the kinds of functions shown in the figure below simply by turning the <  > dial on screens such as this one that are accessed by pressing <  >.

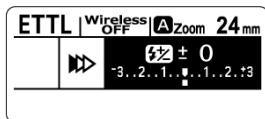



A	E TTL	±0
B	E TTL	±0
C	E TTL	±0
D	E TTL	±0
E	E TTL	±0

- **0: OFF (Disabled)**

Normal method of operation.

- **1: ON (Enabled)**

Enables selection of setting options (for the flash exposure compensation amount, manual flash output, firing group control, flash ratio, flash modes in group firing, and receiver firing groups) with the <  > cross keys and direct configuration simply by turning the <  > dial.

Custom Flash Modes

- [Registering Custom Flash Modes](#)
- [Canceling Automatic Updating](#)
- [Clearing Registered Custom Flash Modes](#)
- [Linking with Camera Shooting Modes](#)

The Speedlite can be used with settings for flash modes and wireless functions that you register in advance.

Note

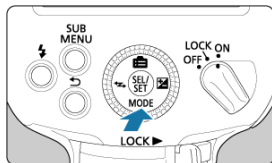

- Initially, Custom flash modes are as follows.
 - C1: E TTL
 - C2: E TTL
 - C3: E TTL

1. Press the <MODE> button on the <⬅➡> cross keys.

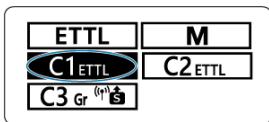

2. Set the flash mode.



- Turn the <  > dial, select one of < **C1** >, < **C2** >, and < **C3** >, and then press <  >.
- Descriptions next to < **C1** >–< **C3** > vary depending on the registered settings.

Registering Custom Flash Modes

You can register current Speedlite settings such as general flash functions, Custom functions (except C.Fn-00) (🔒), and Personal functions (🔒) as Custom flash modes assigned to < C1 >-< C3 > modes.

1. Press the < SUB MENU > button.

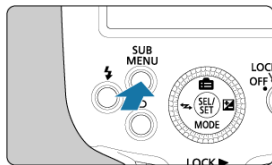

2. Select < C.Flash mode >.

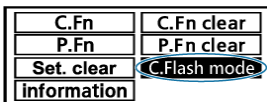

- Turn the < ⓪ > dial to select < C.Flash mode >, then press < ⓪ >.

3. Choose a Custom flash mode to register the settings to.

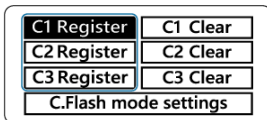

- Turn the < ⓪ > dial, select one of < C1 register >, < C2 register >, and < C3 register >, and then press < ⓪ >.

4. Register the desired items.

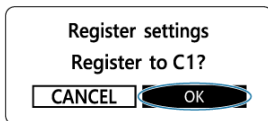

- Turn the < Ⓞ > dial to select < **OK** >, then press < Ⓞ >.

Canceling Automatic Updating

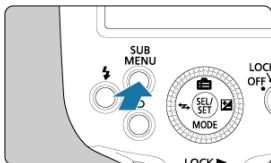

If you change a setting while shooting in Custom flash mode, the mode can be automatically updated with the new setting. By default, this feature is enabled (< >).

1. Press the < SUB MENU > button.



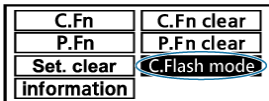

2. Select < **C.Flash mode** >.

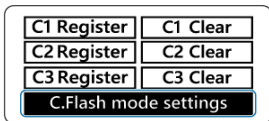

- Turn the <  > dial to select < **C.Flash mode** >, then press <  >.

3. Select < **C.Flash mode settings** >.



- Turn the <  > dial to select < **C.Flash mode settings** >, then press <  >.

4. Select < Auto update set >.

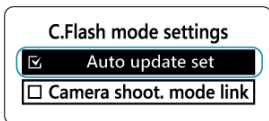

- Turn the <  > dial to select < Auto update set >, then press <  >.

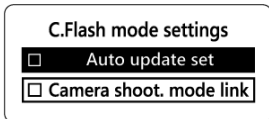

- Display then changes to < Auto update set >.

Clearing Registered Custom Flash Modes

On the screen of step 3 in [Registering Custom Flash Modes](#), select the Custom flash mode to clear (< **C1 clear** >, < **C2 clear** >, or < **C3 clear** >). General flash functions, Custom functions (except C.Fn-00) (☒), and Personal functions (☒) are cleared.

Linking with Camera Shooting Modes

Custom flash modes can be used in conjunction with Custom shooting modes on a camera. For camera instructions, refer to the camera instruction manual.

Available flash modes vary depending on the camera shooting mode. [E-TTL II flash metering] and [Manual flash] are available in <Fv>, <P>, <Tv>, <Av>, <M>, and <bulb (B)> (Creative Zone) modes. When the camera is in a Custom shooting mode (<C1>–<C3>), the Speedlite switches to the corresponding Custom flash mode.

1. Press the <SUB MENU> button.

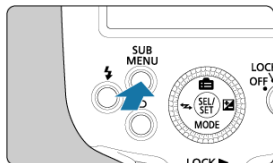

2. Select <C.Flash mode>.

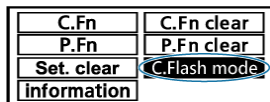

- Turn the <⊙> dial to select <C.Flash mode>, then press <⊙>.

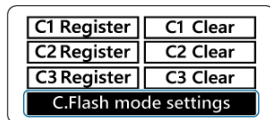

3. Select <C.Flash mode settings>.

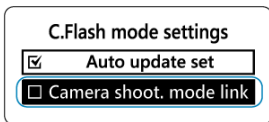

- Turn the <⊙> dial to select <C.Flash mode settings>, then press <⊙>.

4. Select < Camera shoot. mode link >.



- Turn the <  > dial to select < Camera shoot. mode link >, then press <  >.

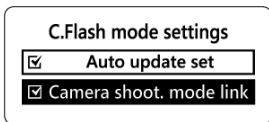

- Display then changes to < Camera shoot. mode link >.

 **Caution**

- When the role of receiver is registered in a Custom flash mode, that mode cannot be linked to camera shooting modes.

 **Note**

- Custom flash modes are only linked to camera modes when the Speedlite is used with cameras that have Custom shooting modes.
- Custom shooting and flash modes with the same number are linked. When used with cameras without Custom shooting mode < **C3** >, the Speedlite's Custom flash mode < **C3** > is not available.
- When Speedlite flash modes are linked to camera shooting modes, flash mode icons (< **C1** >, < **C2** >, and < **C3** >) are displayed with a dotted line and cannot be selected.

Reference

This chapter describes the flash system and includes frequently asked questions.

- [Flash Firing Restriction Due to Temperature Increase](#)
- [Troubleshooting Guide](#)
- [Specifications](#)
- [Accessories](#)

Flash Firing Restriction Due to Temperature Increase

 [Temperature Increase Warning](#)

 [Continuous Flash Count and Rest Time](#)



Repeated use of continuous flash or modeling flash at short intervals may increase the temperature of the flash head, battery, and areas near the battery compartment.

Repeated flash firing gradually increases the firing interval, up to approx. 4 sec., to avoid wearing out or damaging the flash head from overheating. Continuing to fire in this state will automatically restrict flash firing.

Note that when flash firing is restricted, a temperature increase warning icon is displayed, and the flash photography firing interval is automatically set to approx. 10 or 45 sec. (levels 1 and 2, respectively).

Temperature Increase Warning

At each of the two levels, a different warning icon is displayed as the internal temperature rises. Continuing to fire after level 1 is reached changes the state to level 2.

Display / Beeping	Level 1 (Firing Interval: Approx. 10 sec.)	Level 2 (Firing Interval: Approx. 45 sec.)
Icon		
LCD panel illumination	Lit	Blinking

Continuous Flash Count and Rest Time

The following table shows the estimated continuous flash count until level 1 warning display, along with the estimated rest time required until normal flash photography can be resumed.

Function	Estimated Continuous Flash Count Until Level 1 Warning			Estimated Rest Time Required
	Flash Coverage			
	14 mm*1, 24 mm– 28 mm	35 mm	50 mm–105 mm	
Continuous, at full output (🔊)	32 times or more	47 times or more	55 times or more	At least 35 min.
Modeling flash (🔊)				

* As measured in manual flash mode according to Canon testing standards.

* Uses new AA/LR6 alkaline batteries

* 1: When using the wide panel

Caution

- **Do not touch the flash head, battery, or near the battery compartment after continuous flash firing.**

After repeated use of continuous flash or modeling flash at short intervals, do not touch the flash head, battery, or near the battery compartment. The flash head, battery, and area near the battery compartment may become hot, which poses a risk of burns.

Caution

- Do not open or close the battery compartment cover while flash firing is restricted. This will cancel the flash firing restriction, which is potentially very dangerous.
- The firing interval becomes longer as the flash head becomes hotter, even if no level 1 warning is displayed.
- After a level 1 warning appears, stop using the Speedlite for at least 35 min.
- Even if you stop firing after a level 1 warning appears, a level 2 warning may still be displayed.
- Flash photography in < **ETTL** > flash mode or in high temperatures may restrict the flash count sooner than indicated in the table.
- For flash count precautions, see [Continuous Flash Firing](#) and [Modeling Flash](#).
- In rare cases, environmental factors such as temperature increase may prevent firing.
- No warning is given by LCD panel illumination when C.Fn-22 is set to [1] (🔊), even if the flash head becomes hot.

Troubleshooting Guide

☑ [Normal flash photography](#)

☑ [Radio transmission wireless flash photography](#)

☑ [Linked shooting](#)

Troubleshoot Speedlite issues as described in this section. If the problem persists, contact a Canon Service Center.

Normal flash photography

The power does not turn on.

- Make sure the batteries are inserted facing the right direction (☑).
- Make sure the battery compartment cover is closed (☑).
- Replace the batteries with new ones.

The Speedlite does not fire.

- Insert the mounting foot all the way into the camera hot shoe and slide the lock lever right to secure the Speedlite to the camera (☑).
- If < **CHARGE** > remains displayed even after approx. 15 sec., replace the batteries (☑).
- Blow off any foreign material on the contacts between the Speedlite and camera with a commercially available blower or similar tool.
- If the contacts between the Speedlite and camera (☑) get wet, turn off the Speedlite and allow it to dry.
- The firing interval becomes longer (☑) after continuous firing over a short period, which will cause the flash head temperature to rise and restrict flash firing.

The power turns off by itself.

- The Speedlite's auto power off has been activated (☑). Press the shutter button halfway, or press the test flash button (☑).

Pictures are under or overexposed.

- If the main subject looks very dark or very bright, set flash exposure compensation (☑).
- If there are highly reflective objects in the picture, use FE lock (☑).
- With high-speed sync, the faster the shutter speed, the lower the guide number. Move closer to the subject (☑).

The bottom of the picture looks dark.

- Shoot at least 0.5 m / 1.6 ft. away from the subject.
- Remove any attached lens hoods.

The picture periphery looks dark.

- Set the flash coverage to < **A** > (Auto) (☑).
- When manually setting the flash coverage, set a flash coverage wider than the shooting angle of view (☑).
- Make sure C.Fn-21 is not set to [1] (☑).

Pictures are very blurry.

- Shooting in < **Av** > aperture-priority AE mode under low light automatically activates slow-sync shooting, which results in slower shutter speeds. Use a tripod, or set the shooting mode to < **P** > program AE or fully automatic mode (☑). Note that you can also set the flash sync speed in the camera setting [**Flash sync. speed in Av mode**] (☑).

Flash coverage is not set automatically.

- Set the flash coverage to < **A** > (Auto) (☑).
- Insert the mounting foot all the way into the camera hot shoe and slide the lock lever right to secure the Speedlite to the camera (☑).

Flash coverage cannot be set manually.

- Remove the bounce adapter (☑).
- Retract the wide panel (☑).

Functions cannot be set.

- Set the camera's shooting mode to < **Fv** >, < **P** >, < **Tv** >, < **Av** >, < **M** >, or < **Bulb (B)** > (Creative Zone).
- Set the Speedlite's power switch to < **ON** > instead of < **LOCK** > (☑).

Receivers do not fire or unexpectedly fire at full output.

- Set the sender to <(☑) **SENDER**> and receivers to <(☑) **RECEIVER**> (☑).
- Use the same settings for transmission channels and wireless radio IDs on the sender and receivers (☑).
- Make sure receivers are within transmission range of the sender (☑).
- Run a transmission channel scan and set the channel with the strongest signal (☑).
- To the extent possible, position receivers within a direct line of sight of the sender.
- Make sure receivers are facing the sender.
- The camera's built-in flash cannot be used as a sender in radio transmission wireless flash photography.

Pictures are overexposed.

- When using autoflash with three firing groups (A–C), do not fire with firing group C pointing toward the main subject (☑).
- When shooting with each firing group set to its own flash mode, do not fire multiple firing groups in <**ETTL**> mode that are all pointing toward the main subject (☑).

<Tv> is displayed.

- Set the shutter speed one step slower than the maximum flash sync shutter speed (☑).

LCD panel illumination turns on and off.

- The sender LCD panel turns on or off based on receiver (firing group) recharge status. See [LCD Panel Illumination](#).

Standard exposure is not provided, or exposure is uneven.

- Firing multiple Speedlites together in linked shooting may prevent suitable exposure or cause uneven exposure. Consider firing only one Speedlite or using a self-timer to fire multiple units at different times.

Specifications

Type

Type	Shoe-mount E-TTL II/E-TTL autoflash Speedlite
Compatible cameras	EOS R series cameras with a multi-function shoe * For details, refer to the Canon website (G).

Flash head (light-emitting unit)

Guide number	Normal flash guide number Maximum guide number (at approx. ISO 100)									
	Light distribution	Unit	Flash coverage							
			14 mm*1	24 mm	28 mm	35 mm	50 mm	70 mm	80 mm	105 mm
	Standard	m	12.1	20.7	22.2	25.2	29.6	36.1	37.3	40.5
		ft.	39.7	67.9	72.8	82.7	97.1	118.4	122.4	132.9
	Guide number priority	m		24.1	25.2	29.6	36.1	40.5	40.5	40.5
		ft.		79.1	82.7	97.1	118.4	132.9	132.9	132.9
	Even coverage	m		20.7	20.7	20.7	24.1	26.9	29.6	32.5
		ft.		67.9	67.9	67.9	79.1	88.3	97.1	106.6
	* 1: When using the wide panel									
High-speed sync guide number Maximum guide number (at approx. ISO 100)										
Shutter speed	Unit	Flash coverage								
		14 mm*1	24 mm	28 mm	35 mm	50 mm	70 mm	80 mm	105 mm	
1/125	m	7.5	12.5	13.4	15.2	17.8	21.8	22.5	24.4	
	ft.	24.6	41.0	44.0	49.9	58.4	71.5	73.8	80.1	
1/250	m	6.0	9.9	10.6	12.1	14.2	17.3	17.9	19.4	
	ft.	19.7	32.5	34.8	39.7	46.6	56.8	58.7	63.6	
1/500	m	4.2	7.0	7.5	8.5	10.0	12.2	12.6	13.7	
	ft.	13.8	23.0	24.6	27.9	32.8	40.0	41.3	44.9	
1/1000	m	3.0	5.0	5.3	6.0	7.1	8.6	8.9	9.7	
	ft.	9.8	16.4	17.4	19.7	23.3	28.2	29.2	31.8	
1/2000	m	2.1	3.5	3.8	4.3	5.0	6.1	6.3	6.9	
	ft.	6.9	11.5	12.5	14.1	16.4	20.0	20.7	22.6	
1/4000	m	1.5	2.5	2.7	3.0	3.5	4.3	4.5	4.8	
	ft.	4.9	8.2	8.9	9.8	11.5	14.1	14.8	15.7	
1/8000	m	1.1	1.8	1.9	2.1	2.5	3.1	3.2	3.4	
	ft.	3.6	5.9	6.2	6.9	8.2	10.2	10.5	11.2	
* 1: When using the wide panel										

Manual flash guide number
Maximum guide number (at approx. ISO 100)

Flash output	Unit	Flash coverage							
		14 mm*1	24 mm	28 mm	35 mm	50 mm	70 mm	80 mm	105 mm
1/1	m	12.1	20.7	22.2	25.2	29.6	36.1	37.3	40.5
	ft.	39.7	67.9	72.8	82.7	97.1	118.4	122.4	132.9
1/2	m	8.6	14.6	15.7	17.8	20.9	25.5	26.4	28.6
	ft.	28.2	47.9	51.5	58.4	68.6	83.7	86.6	93.8
1/4	m	6.1	10.4	11.1	12.6	14.8	18.1	18.7	20.3
	ft.	20.0	34.1	36.4	41.3	48.6	59.4	61.4	66.6
1/8	m	4.3	7.3	7.8	8.9	10.5	12.8	13.2	14.3
	ft.	14.1	24.0	25.6	29.2	34.4	42.0	43.3	46.9
1/16	m	3.0	5.2	5.6	6.3	7.4	9.0	9.3	10.1
	ft.	9.8	17.1	18.4	20.7	24.3	29.5	30.5	33.1
1/32	m	2.1	3.7	3.9	4.5	5.2	6.4	6.6	7.2
	ft.	6.9	12.1	12.8	14.8	17.1	21.0	21.7	23.6
1/64	m	1.5	2.6	2.8	3.2	3.7	4.5	4.7	5.1
	ft.	4.9	8.5	9.2	10.5	12.1	14.8	15.4	16.7
1/128	m	1.1	1.8	2.0	2.2	2.6	3.2	3.3	3.6
	ft.	3.6	5.9	6.6	7.2	8.5	10.5	10.8	11.8
1/256*2	m	0.8	1.3	1.4	1.6	1.9	2.3	2.3	2.5
	ft.	2.6	4.3	4.6	5.2	6.2	7.5	7.5	8.2
1/512*2	m	0.5	0.9	1.0	1.1	1.3	1.6	1.6	1.8
	ft.	1.6	3.0	3.3	3.6	4.3	5.2	5.2	5.9
1/1024*2	m	0.4	0.6	0.7	0.8	0.9	1.1	1.2	1.3
	ft.	1.3	2.0	2.3	2.6	3.0	3.6	3.9	4.3

* 1: When using the wide panel
* 2: Not available with high-speed sync

Flash coverage
(focal length; for
35mm full-frame)

14 mm	Wide panel: Manual * Not compatible with EF15mm f/2.8 Fisheye or EF8-15mm f/4L Fisheye USM shooting angles of view
24 mm	Zoom
28 mm	<ul style="list-style-type: none"> • Auto Flash coverage is set automatically, accounting for [Auto zoom for sensor size] and [Light distribution] settings at the lens focal length • Manual Flash coverage is set manually * [Auto zoom for sensor size] and [Light distribution] settings are not taken into account
35 mm	
50 mm	
70 mm	
80 mm	
105 mm	

Bounce angle	Bounce direction		Bounce angle (approx.)					
	Up	0°	45°	60°	75°	90°		
	Left	0°	60°	75°	90°	120°	150°	
	Right	0°	60°	75°	90°	120°	150°	180°
<p>* Click stops at the angles above. * Downward bounce is not possible.</p>								
Flash duration	Normal flash							
	Flash output	Flash duration (approx., sec.)		Flash output		Flash duration (approx., sec.)		
	1/1	1/790		1/64		1/12030		
	1/2	1/1440		1/128		1/14430		
	1/4	1/2830		1/256		1/17290		
	1/8	1/4830		1/512		1/19400		
	1/16	1/7370		1/1024		1/21190		
1/32	1/10110							
Color temperature information transmission	Supported							

Exposure control

Flash modes (exposure control modes)	Flash modes and available functions				
	Flash mode	Mounted	Radio transmission wireless		
	E-TTL i/E-TTL autoflash*1	○	○		
	Manual flash	○	○		
	Custom flash	Following the registered flash mode			
Group firing	—	○			
	* 1: Set automatically when the camera shooting mode is set to Basic Zone modes.				
Effective flash range	Effective flash range is as follows under these conditions:				
	<ul style="list-style-type: none"> • Sensor size: 35mm full-frame • Flash coverage: 50 mm • Aperture value: f/1.4 • ISO 100 • Light distribution: Standard 				
	Firing conditions	Effective flash range (approx.)			
Normal flash (Flash-ready lamp: lit in red)	0.7–22.1 m / 2.3–72.5 ft.				
Quick flash (Flash-ready lamp: blinking in red)	0.7–12.9 m / 2.3–42.3 ft.				
High-speed sync (Shutter speed: 1/250 sec.)	0.7–10.1 m / 2.3–33.1 ft.				
Flash exposure compensation	±3 stops (in 1/3-stop or 1/2-stop increments) * Speedlite flash exposure compensation takes precedence if compensation is also set on the camera. * Speedlite flash exposure compensation should be set to 0 to enable flash exposure compensation by the camera.				
FEB	Not available * FEB possible when used as a receiver.				
FE lock	Supported				
FE memory	Supported				
Synchronization	Flash firing	Flash mode	1st-curtain sync	2nd-curtain sync	High-speed sync
	Mounted (Wireless OFF)	E-TTL i/E-TTL autoflash	○	○	○
		Manual flash	○	○	○
	Radio transmission wireless sender	E-TTL i/E-TTL autoflash	○	○	○
		Manual flash	○	○	○
Group firing		○	○	○	

Flash recharge

Recharge time	Recharge time (approx.)		
	Battery	Quick flash	Normal flash
	AA / LR6 alkaline batteries	0.1–2.2 sec.	0.1–2.5 sec.
	Size AA Ni-MH batteries	0.1–1.3 sec.	0.1–1.5 sec.
<p>* Using new batteries, based on Canon testing standards. * Based on Canon testing standards.</p>			
Flash-ready indication	Charging in progress	Quick flash	Normal flash (fully charged)
	Flash-ready lamp	Off	Blinking in red (8 Hz)
	LCD Panel	CHARGE 6-level display	—

AF-assist beam

Intermittent flash firing mode	<p>The intermittent AF-assist beam is not fired under the following conditions:</p> <ul style="list-style-type: none">- Lens attached: Manual focus (< MF >)- Camera: Set to [Servo AF], or with [AF-assist beam firing] set to [Disable] <ul style="list-style-type: none">• Light emitted Visible light• Compatible AF system Dual Pixel CMOS AF• Effective range				
	<table border="1"><thead><tr><th></th><th>Effective range (approx.)</th></tr></thead><tbody><tr><td>Center AF point</td><td>0.7–10.0 m / 2.3–32.8 ft.</td></tr></tbody></table>		Effective range (approx.)	Center AF point	0.7–10.0 m / 2.3–32.8 ft.
		Effective range (approx.)			
Center AF point	0.7–10.0 m / 2.3–32.8 ft.				
<p>* Lens focal length: 24 mm or longer * Direction emitted: from the flash head at a 0° bounce angle</p>					

Wireless functions via radio transmission

Wireless settings	Sender	Supported * Secondary and additional units serve as sub-senders
	Receiver	Supported
Communication functions	Standards compliance	IEEE 802.15.4, ARIB STD-T66
	Communication method	Primary modulation: OQPSK Secondary modulation: DS-SS
	Transmission frequency	2405–2475 MHz
	Channel	Channel 1–15 Setting: Auto/Manual
	Wireless radio ID	0000–9999 Setting: Manual
	Transmission range^{*1,2}	Approx. 30 m / 98.4 ft.
	Groups	Up to 5 groups (A/B/C/D/E) * Sender units are set to Group A
	Max. units for communication	Up to 16 senders and receivers, combined
	Max. sender units	Up to 15 * Secondary and additional units serve as sub-senders
	Max. receiver units	Up to 15
<p>* 1: Without any obstructions between senders and receivers, and without radio interference from other devices. * 2: Transmission range may be shorter depending on factors such as how units are arranged, the surrounding environment, and weather conditions.</p>		
Linked functions	<p>Supports linked shooting with automatic shutter release of up to 16 cameras (sender: 1; receivers: 15) linked to shutter release on the sender camera. * Shooting with precisely the same timing is not possible, as receiver cameras shoot slightly after the sender camera shutter release.</p>	

Power source

Battery pack	4 × AA/LR6 alkaline batteries * AA/HR6 Ni-MH batteries can be used, AA/FR6 lithium batteries cannot be used.																					
External power source	Not supported																					
Maximum flash count	<table border="1"> <thead> <tr> <th>Battery</th> <th>Quick flash</th> </tr> </thead> <tbody> <tr> <td>AA / LR6 alkaline batteries</td> <td>Approx. 210–1400 times</td> </tr> <tr> <td>Size AA Ni-MH batteries</td> <td>Approx. 260–1700 times</td> </tr> </tbody> </table> <p>* Using new batteries, based on Canon testing standards. * Based on Canon testing standards.</p>	Battery	Quick flash	AA / LR6 alkaline batteries	Approx. 210–1400 times	Size AA Ni-MH batteries	Approx. 260–1700 times															
Battery	Quick flash																					
AA / LR6 alkaline batteries	Approx. 210–1400 times																					
Size AA Ni-MH batteries	Approx. 260–1700 times																					
Radio transmission wireless shooting time	Approx. 9 hr. continuously * Time until the Speedlite turns off with sender flash firing disabled, when using radio transmission wireless. * Using new AA/LR6 alkaline batteries, based on Canon testing standards.																					
Auto power off	<p>When EL-10 is attached to a camera, the time from when the camera switches off, or auto power off mode is activated until the Speedlite turns off due to inactivity. * Since the Speedlite can detect the state of the connection with the camera, while the camera is on, it does not (unintentionally) enter auto power off by itself.</p> <table border="1"> <thead> <tr> <th>Status</th> <th>Custom Function</th> <th>Time</th> </tr> </thead> <tbody> <tr> <td>During normal operation</td> <td>C.Fn-01-0</td> <td>Approx. 90 sec.</td> </tr> <tr> <td>When set as a sender in radio transmission wireless operation</td> <td>C.Fn-01-0</td> <td rowspan="2">Approx. 5 min.</td> </tr> <tr> <td>During linked shooting</td> <td>C.Fn-01-0</td> </tr> <tr> <td rowspan="2">When set as a receiver in radio transmission wireless operation</td> <td>C.Fn-10-0</td> <td>Approx. 60 min.</td> </tr> <tr> <td>C.Fn-10-1</td> <td>Approx. 10 min.</td> </tr> <tr> <td rowspan="2">Standby before power ON after auto power off when set as a receiver</td> <td>C.Fn-11-0</td> <td>Approx. 8 hr.</td> </tr> <tr> <td>C.Fn-11-1</td> <td>Approx. 1 hr.</td> </tr> </tbody> </table> <p>Reactivated in response to the following operations:</p> <ul style="list-style-type: none"> Pressing the camera shutter button halfway Test flash button When selecting the (Speedlite) menu direct function <  > with EL-10 attached to a camera. 	Status	Custom Function	Time	During normal operation	C.Fn-01-0	Approx. 90 sec.	When set as a sender in radio transmission wireless operation	C.Fn-01-0	Approx. 5 min.	During linked shooting	C.Fn-01-0	When set as a receiver in radio transmission wireless operation	C.Fn-10-0	Approx. 60 min.	C.Fn-10-1	Approx. 10 min.	Standby before power ON after auto power off when set as a receiver	C.Fn-11-0	Approx. 8 hr.	C.Fn-11-1	Approx. 1 hr.
Status	Custom Function	Time																				
During normal operation	C.Fn-01-0	Approx. 90 sec.																				
When set as a sender in radio transmission wireless operation	C.Fn-01-0	Approx. 5 min.																				
During linked shooting	C.Fn-01-0																					
When set as a receiver in radio transmission wireless operation	C.Fn-10-0	Approx. 60 min.																				
	C.Fn-10-1	Approx. 10 min.																				
Standby before power ON after auto power off when set as a receiver	C.Fn-11-0	Approx. 8 hr.																				
	C.Fn-11-1	Approx. 1 hr.																				

Dimensions/weight

Dimensions		W × H × D
	Body	Approx. 70.6 × 116.3 × 98.3 mm / 2.78 × 4.58 × 3.87 in.
Weight		Weight
	Body	Approx. 287 g / 10.1 oz.

Operation environment

Working temperature range	0–45°C / 32–113°F
Working humidity	85 % or less

- All specifications above are based on Canon's testing standards.
- Product specifications and external appearance are subject to change without notice.

Accessories

Use of genuine Canon accessories is recommended

Because this product is designed for optimal performance with genuine Canon accessories, use with genuine accessories is recommended.

Note that Canon shall not be liable for any damage to this product and/or accidents such as malfunction, fire, etc. caused by the failure of non-genuine Canon accessories. Please note that any repair of Canon products that is required as a result is not covered under warranty but may be available for a fee.