



# MC Pro 8-Light Kit

## Product Manual

English

# Introduction

Thank you for purchasing the Aputure® MC Pro.

The MC Pro 8-Light Kit is built for professional lighting technicians and rental houses. Enhance your existing workflows using the MC Pro's complete color control and advanced wireless connectivity using LumenRadio® CRMX or our innovative Sidus Link® mobile app. Light confidently with the MC Pro's durable IP65 construction, magnetic lighting accessories, and integrated battery that effortlessly powers up in the custom charging case. As part of your essential lighting package, the MC Pro 8-Light Kit contains all the tools needed to unlock new light possibilities, so you and your equipment will be ready whenever creativity strikes.

## Important Safety Instructions

When using this unit, basic safety precautions should always be followed, including the following:

### Warning

When using the charging case to charge, avoid closing the charging case cover, as the charging will overheat.

- 1 . Read and understand all instructions before using.
- 2 . Please keep MC Pro away from diskette, credit cards, monitors, mechanical watches, mobile phones, medical devices (pacemakers), etc.
- 3 . Close supervision is necessary when any fixture is used by or near children. Do not leave the fixture unattended while in use.
- 4 . Care must be taken as burns can occur from touching hot surfaces.
- 5 . This product is a precision instrument, please avoid precision collision or heavy impact during use.
- 6 . Do not operate the fixture if a cord is damaged, or if the fixture has been dropped or damaged, until it has been examined by qualified service personnel.
- 7 . Position any power cables such that they will not be tripped over, pulled, or put into contact with hot surfaces.
- 8 . If an extension cord is necessary, a cord with an amperage rating at least equal to that of the fixture should be used. Cords rated for less amperage than the fixture may overheat.
- 9 . Always unplug the lighting fixture from the electrical outlet before cleaning and servicing, or when not in use. Never yank the cord to remove the plug from the outlet.
- 10 . Let the lighting fixture cool completely before storing. Unplug the power cable from lighting fixture before storing and store the cable at assigned space of the carrying case.
- 11 . To reduce the risk of electric shock, do not immerse this fixture in water or any other liquids.
- 12 . To reduce the risk of fire or electric shock, do not disassemble this fixture. Contact [cs@aputure.com](mailto:cs@aputure.com) or take the lighting fixture to qualified service personnel when service or repair is required. Incorrect reassembly may cause electric shock when the lighting fixture is in use.

13. The use of any accessory attachment not recommended by the manufacturer may increase the risk of fire, electric shock, or injury to any persons operating the fixture.
14. Please power this fixture by connecting it to a grounded outlet.
15. Please do not block the ventilation or do not look at the LED light source directly when it is powered on. Please do not touch the LED light source in any condition.
16. Please do not place the LED lighting fixture near any flammable object.
17. Only use a dry microfiber cloth to clean the product.
18. Please do not use the light fixture in wet condition on account of electric shock may be caused.
19. Please have the product checked by an authorized service personnel agent if the product has a problem. Any malfunctions caused by unauthorized disassembly are not covered by the warranty. The user may pay for maintenance.
20. We recommend only using the original Aputure® cable accessories. Please note that any malfunctions caused by using unauthorized accessories are not covered by the warranty. The user may pay for maintenance.
21. This product is certified by RoHS, CE, KC, PSE, and FCC. Please operate the product in full compliance with relevant country's standards. Any malfunctions caused by incorrect use are not covered by warranty. The user may pay for maintenance.
22. The instructions and information in this manual are based on thorough, controlled company testing procedures. Further notice will not be given if the design or specifications change.

# SAVE THESE INSTRUCTIONS

## FCC Compliance Statement

### WARNING

Changes or modifications not expressly approved by the party responsible for compliance could void the user's authority to operate the equipment.

### NOTICE

This equipment has been tested and found to comply with the limits for a Class B digital device, pursuant to Part 15 of the FCC Rules. These limits are designed to provide reasonable protection against harmful interference in a residential installation. This equipment generates, uses, and can radiate radio frequency energy and, if not installed and used in accordance with the instructions, may cause harmful interference to radio communications. However, there is no guarantee that interference will not occur in a particular installation.

If this equipment does cause harmful interference to radio or television reception, which can be determined by turning the equipment off and on, the user is encouraged to try reorient or relocate the receiving antenna.

- Increase the separation between the equipment and receiver.
- Connect the equipment to an outlet on a different circuit than the receiver is connected to.
- Consult the dealer or an experienced radio/TV technician for help.

## RF Warning Statement:

This device has been evaluated to meet general RF exposure requirements.

# Components List

Please make sure all accessories listed below are completed before using.

If not, please contact with your sellers immediately.

MC Pro 8-Light Kit:

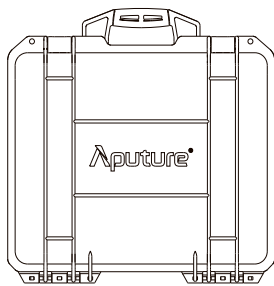

MC Pro 8-Light Charging Case  
x1

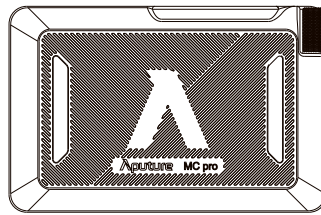

MC Pro  
x8



D-tap to D-tap Power Cable  
x2

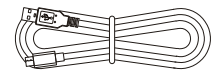

USB Type-C Charging Cables  
x2

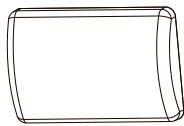

Dome Diffusers  
x8

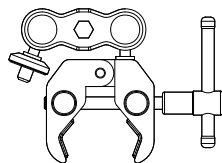

Super Clamp with Ball  
Head Arm & 1/4" Screw  
x2

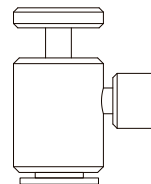

1/4" Coldshoe Ball Heads  
x8



AC Power cable  
x1



Baby Pin with 1/4" Screw  
x4

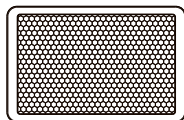

Light Control Grids  
x8



Flat Diffusers  
x8



1/4" Screw to Magnet Adapters  
x8



Metal Adhesive Mounting Pads  
x32

*\* Tips: The illustrations in the manual are only diagrams for reference. Due to the continuous development of new versions of the product, if there are any differences between the product and the user manual diagrams, please refer to the product itself.*

# Product Details

## 1. MC Pro



## 2. MC Pro 8-Light Charging Case



# Installations

## 1. Powered by the charging case— AC Power

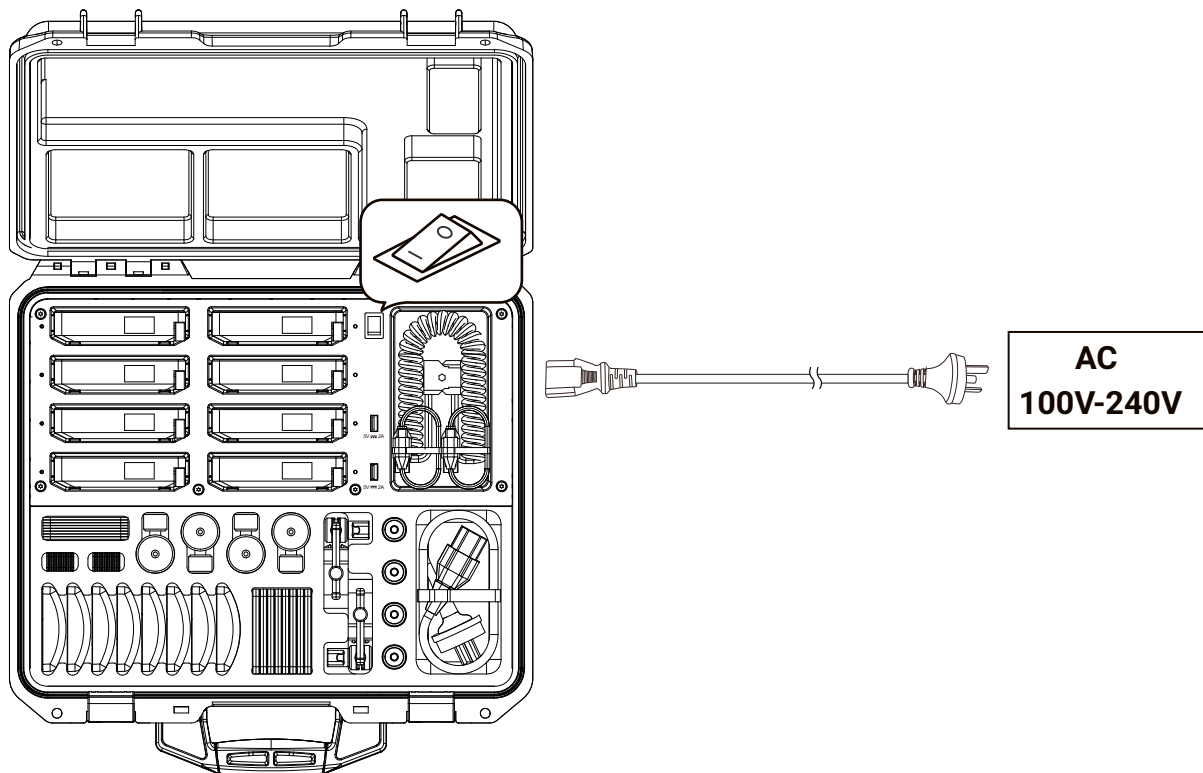

## 2. DC Power

Use a D-tap to D-tap cable to connect the battery to power the charging case.

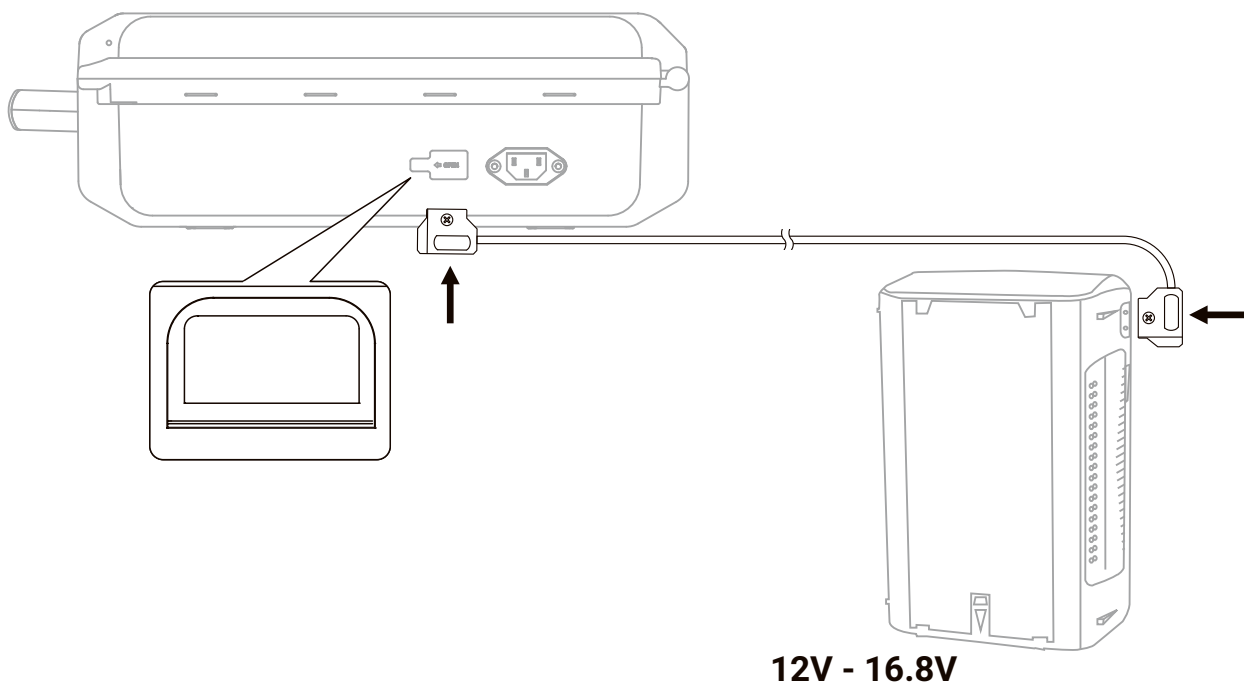

# Operations

## 1. Power ON/OFF

### 1.1 Charging case switch mode

Access the AC power cable and press the switch. When the switch is turned on, the light of the switch turns red.

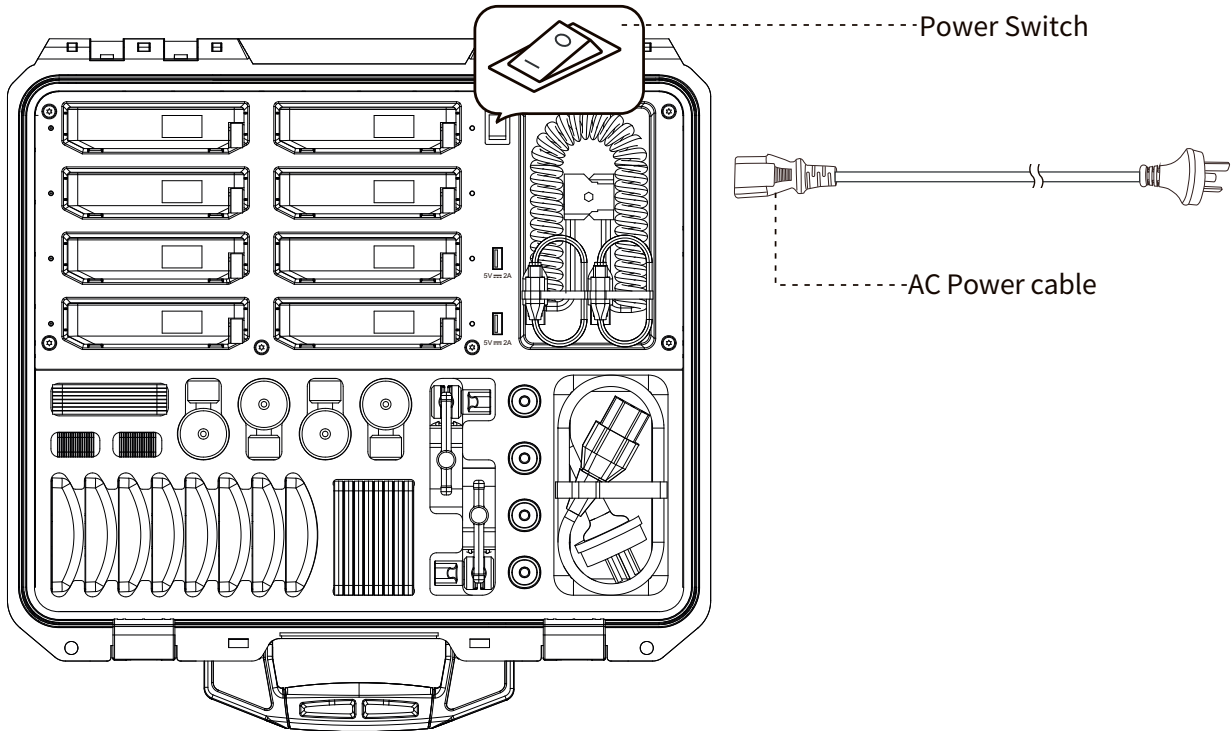

### 1.2 MC Pro switch mode

Press and hold the power button for 1 seconds to turn the MC Pro on or off.

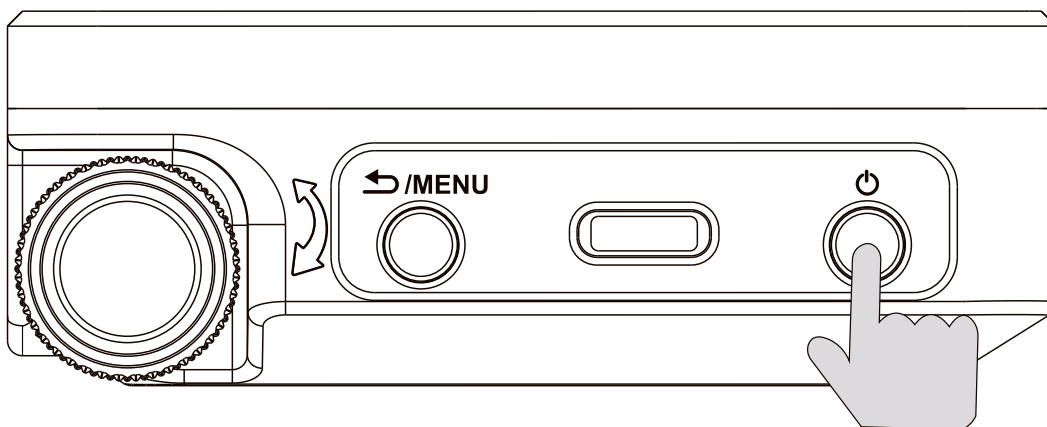

## 2. Charging

### 2.1 USB Type-C Charging

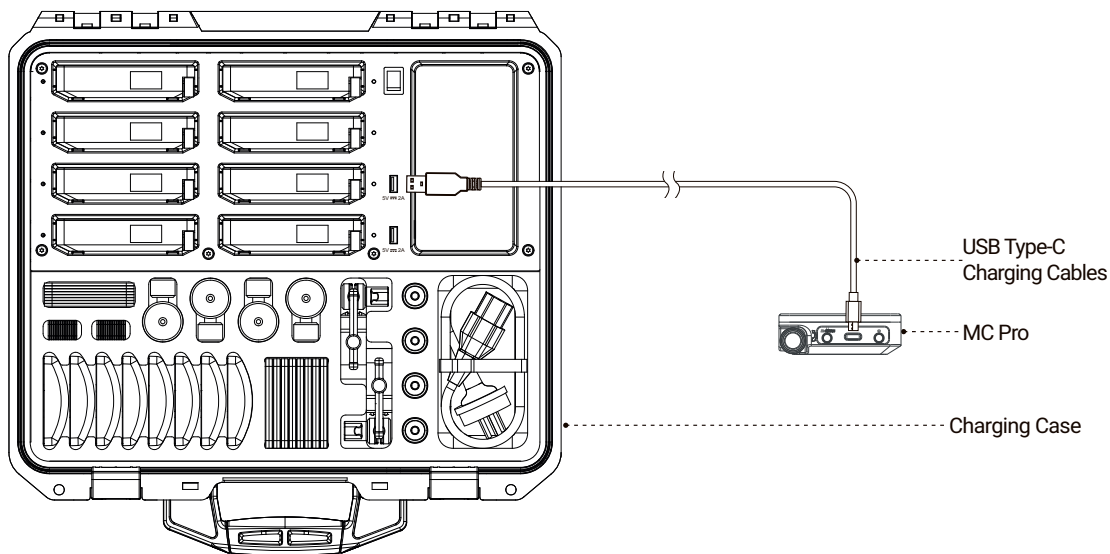

*\*Supports 5V/2A charging via charger or power banks.*

### 2.2 Pogo Pin Charging

The Aputure® MC Pro is compatible with the Pogo Pin charging. First put the MCs Pro in the charging slot of the charging case, then ensure that the charging case is plugged into a compatible power source, then flip the power switch to the ON position. MCs Pro can then be charged with Pogo pins. If an MC Pro is detected and is charging, the charging plot's corresponding status LED will appear red. If the MC Pro's battery is full, the status LED will appear green.

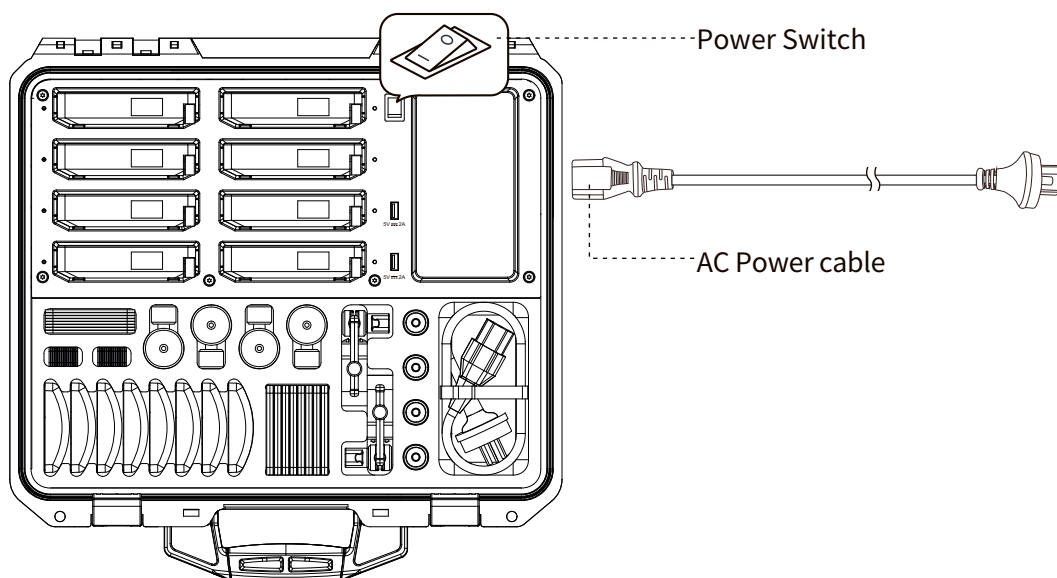



## WARNING

Do not close the lid when the charging case on or in an active charging state, to prevent overheating. Failure to do so will result in the internal temperature of the case and the MC Pros being charged to become extremely hot.

## 3. Manual Control

### 3.1 UI Introducing

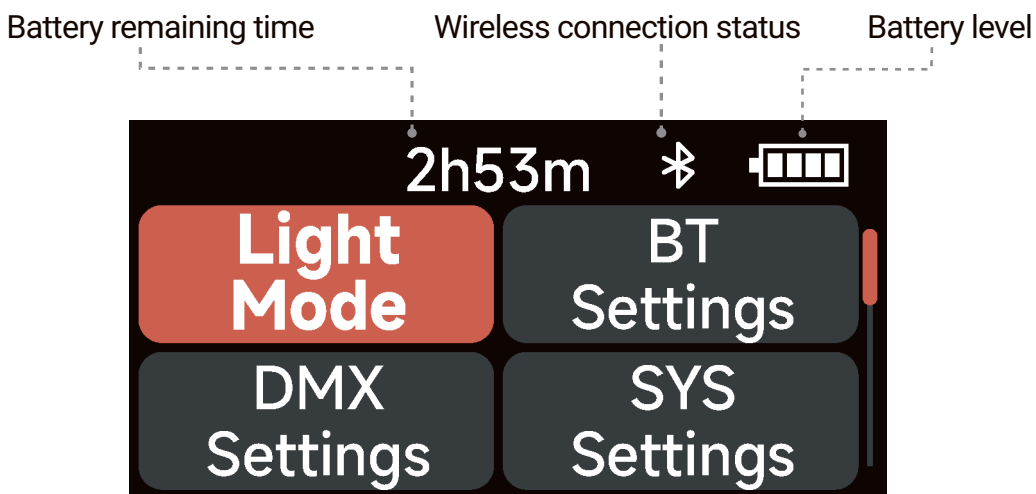

### 3.2 Menu

Press MENU to access the system menu, rotate and press the knob to select the **Light Mode** / **Bluetooth Settings** / **DMX Settings** / **System Settings**.

### 3.3 Light Mode

Rotate and press the knob to select Light Mode in system menu. Rotate and press the knob to select **CCT** / **HSI** / **RGB** / **GEL** / **Source** / **XY** / **FX** / **Custom FX**.

#### 3.3.1 CCT

Rotate and press the knob to select CCT in Light Mode.

**INT** (Intensity): 0.0%- 100.0%

**CCT** (Correlated Color Temp.): 2000 K - 10000 K

**G/M** (Green / Magenta adjustment): -1.0 ~ +1.0

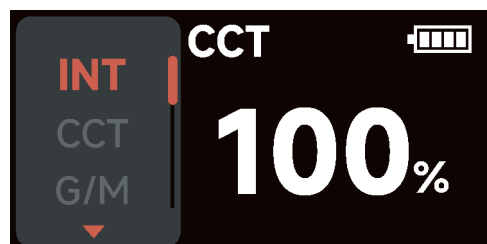

### 3.3.2 HSI

Rotate and press the knob to select HSI in Light Mode.

**INT** (Intensity): 0.0%- 100.0%

**HUE** (Hue): 0.1° - 360.0°

**SAT** (Saturation): 0.0%- 100.0%

**CCT** (Correlated Color Temp.): 2000 K - 10000 K



### 3.3.3 RGB

Rotate and press the knob to select RGB in Light Mode.

**INT** (Intensity): 0.0%- 100.0%

**R** (Red): 0.0%- 100.0%

**G** (Green): 0.0%- 100.0%

**B** (Blue): 0.0%- 100.0%

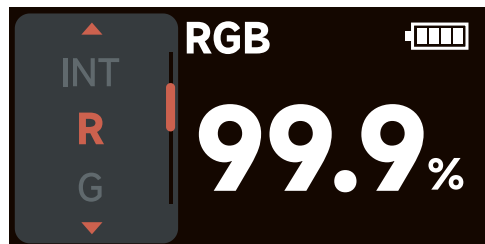

### 3.3.4 GEL

Rotate and press the knob to select GEL in Light Mode.

**INT** (Intensity): 0.0%- 100.0%

**CCT** (Correlated Color Temp.): select 3200 or 5600K as the virtual light color temperature

**ROSCO**: Select a lighting color filter from ROSCO filter library

**LEE**: Select a lighting color filter from LEE filter library



### 3.3.5 Source

Rotate and press the knob to select Source in Light Mode.

**INT** (Intensity): 0.0%- 100.0%

**Source**: Select the light source that best matches the illumination of the scene from the Source library

**X**: Adjust the value of the x coordinate within  $\pm 0.0050$

**Y**: Adjust the value of the y coordinate within  $\pm 0.0050$



### 3.3.6 XY

Rotate and press the knob to select XY in Light Mode.

**INT** (Intensity): 0.0%- 100.0%

**X** (x coordinate): 0.0000 – 0.8000

**Y** (y coordinate): 0.0000 – 0.8000



### 3.3.7 FX

Rotate and press the knob to select FX in Light Mode. Rotate and press the knob to select **Club Lights/Paparazzi/Lightning/TV/Candle/Fire/Strobe/Explosion/Faulty Bulb/Pulsing/Welding/Cop Car/Colors Chase/Party Lights/ Fireworks.**

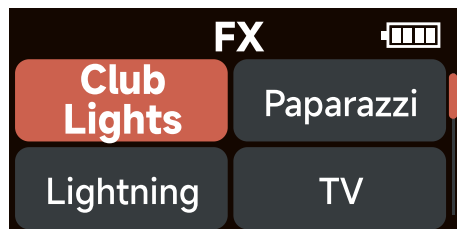

<p><b>1.Club Lights</b></p>	<p><b>2.Paparazzi</b></p>
<p><b>3.Lightning</b></p>	<p><b>4.TV</b></p>

5. Candle

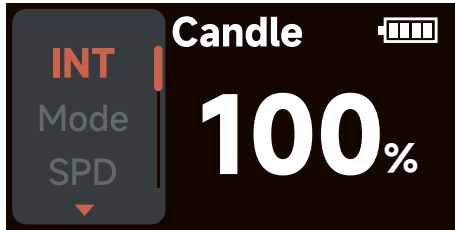

6. Fire



7. Strobe

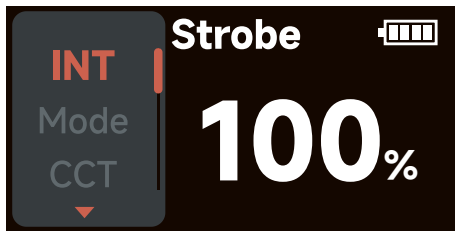

8. Explosion



9. Faulty Bulb

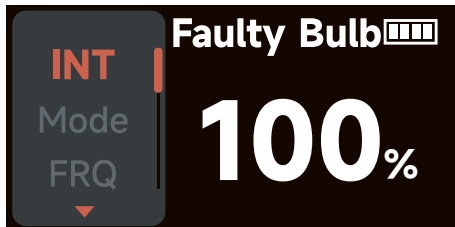

10. Pulsing



11. Welding



12. Cop Car



13. Colors Chase

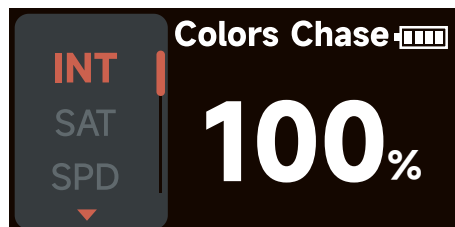

14. Party Lights



15. Fireworks



### 3.3.8 Custom FX

Rotate and press the knob to select FX in Light Mode. You can choose to enter **Music FX** or **Picker FX**. Each type can be uploaded and renamed in Sidus Link with 10 custom effects. "NO CFX" means unsaved FX.

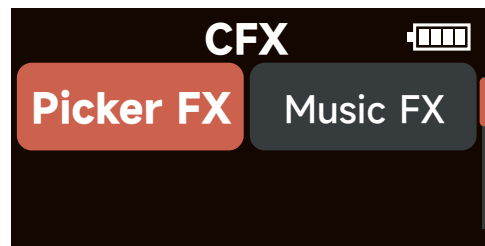

### 3.4 BT Settings

Rotate and press the knob to select BT Settings in system menu, rotate and press the knob to select **BT Status/ BT Reset/ BT UID**.

**BT Status:** Turn on/off Bluetooth.

**BT Reset:** Reset the MC Pro Bluetooth connection, and your mobile phone or tablet will be able to connect to and control the light with Sidus Link App.

**BT UID:** See the Bluetooth Unique Identifier.

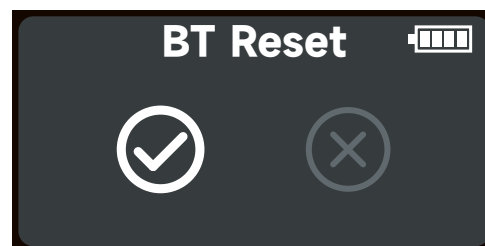
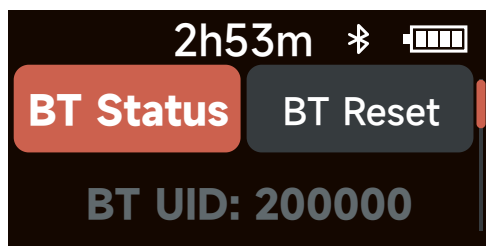

### 3.5 DMX Settings

Rotate and press the knob to select DMX Settings in system menu. Rotates the knob to select **DMX Settings/CRMX Settings**.

#### 3.5.1 DMX Settings

Rotate and press the knob to select DMX Settings in DMX Settings.

**DMX Address:** Choose the DMX address of MC Pro, press and hold the control wheel for 2 seconds to lock/unlock the DMX address (Prevent accidental touch to exit DMX mode).

**DMX Profiles:** Rotate the knob to choose DMX profile.

**DMX Loss Behavior:**

1. Hold Last Settings: After DMX signal is lost, remember the last control setting.
2. Black Out: When the DMX signal is lost, it will be black out.
3. Fade To Black: After DMX signal is lost, it will fade to black in 60 seconds.
4. Hold 2min & Fade Out: After the DMX signal is lost, keep the last control setting for two minutes, and then fade to black within 60 seconds.

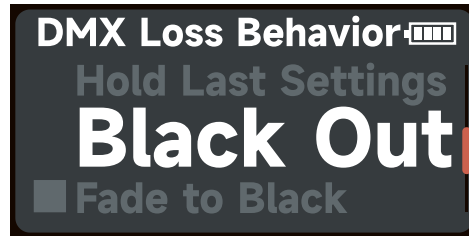
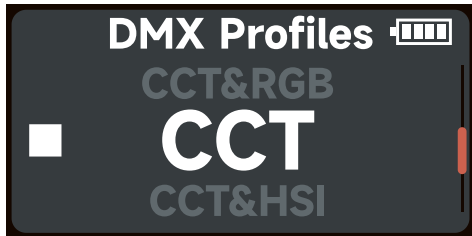
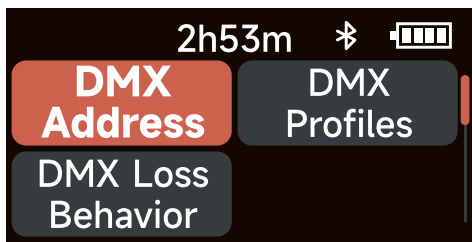

\* The fade-out time decreases as the percentage of brightness decreases. When the brightness output is 100%, the fade-out time is 60 seconds, which decreases in sequence.  
 \* If the signal is reconnected, the DMX console will continue to maintain the signal output as same as before.

### 3.5.2 CRMX Settings

Rotate and press the knob to select CRMX Settings in DMX Settings.

**CRMX Status:** When CRMX Status is ON, it will continuously search for a pairable signal in the background to connect.

**Unpair:** Unpair will disconnects the currently established connection so that other signal transmitters can be paired.

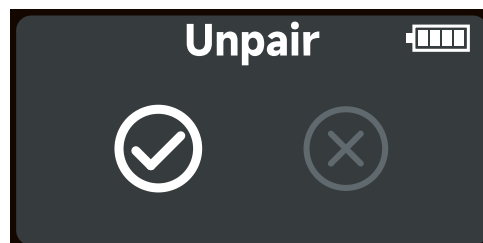
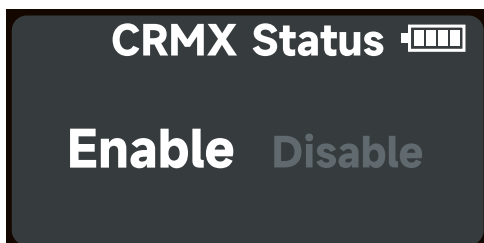

### 3.6 System Settings

Rotate and press the knob to select System Settings in system menu. Rotates and press the knob to select .

**Freq. Selection/Language/Product Info/Factory Reset.**

**Freq. Selection:** Rotate the knob to adjust the light frequency by 100Hz every turn.

**Language:** Rotate and press the knob to select **English** or **Simplified Chinese**.

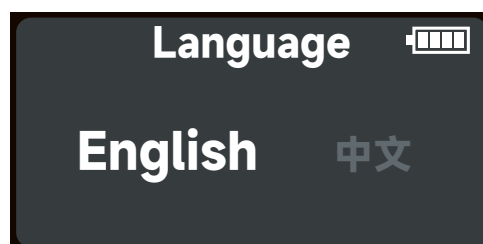
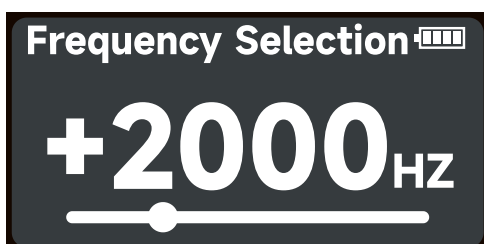

**Product Info:** Rotate and press the knob to select Product Info to see **Firmware Version / Hardware Version**.

**Factory Reset:** Rotate and press the knob to select Factory Reset.

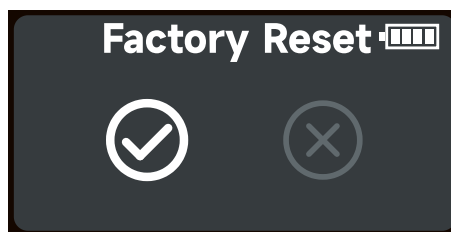
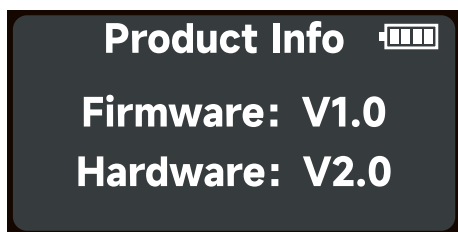

Factory Setting:

Light Mode: Intensity 50%, CCT 5600K, GM 0

BT Status: ON

DMX: Address 001, Profile CCT&RGB, Hold Last Setting, CRMX OFF.

System setting: Freq. Selection 0Hz, Language English.

## 4. Wired DMX Control

### 4.1 Connect a standard DMX controller

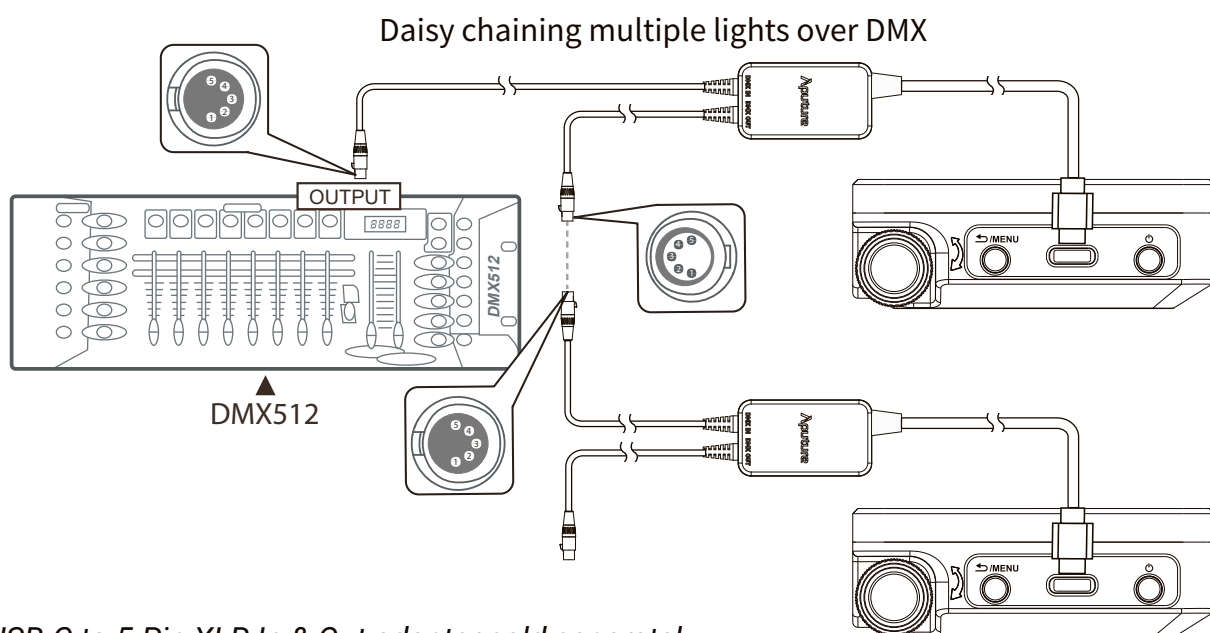
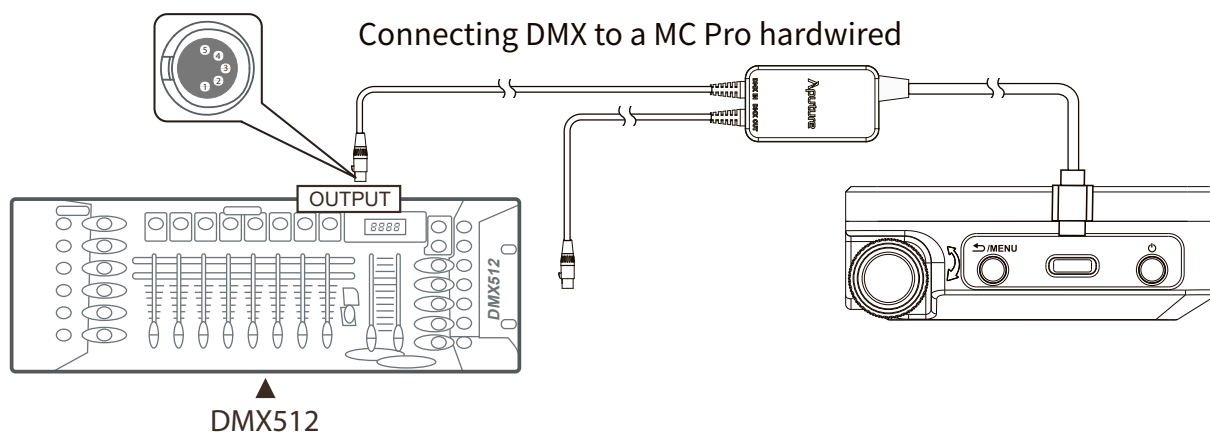

\* USB-C to 5-Pin XLR In & Out adapter sold separately

## 4.2 DMX Interface Info

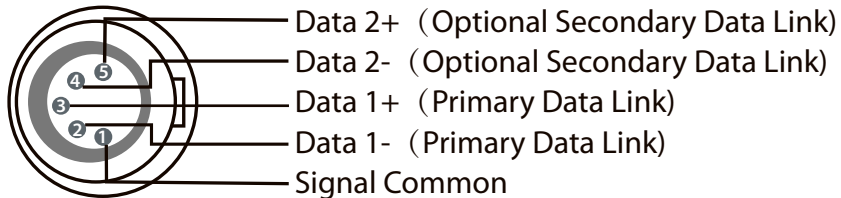
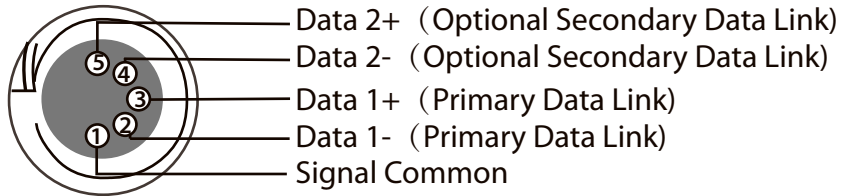

## 4.3 Channel selection

In DMX mode, match the channel of your DMX controller with the light, and then adjust accordingly.

\* The default DMX channel is 001.

\* The range of DMX channels is 1 to 512.

## 4.4 Controlling Device Via DMX

The MC Pro offers a variety of DMX modes. Please find a detailed overview of all DMX modes in the document, DMX Chart is available for free download on the Aputure official website <https://www.aputure.com>.

## 5. Using the Sidus Link APP

You can download the Sidus Link app from the iOS App Store or Google Play Store for enhancing the functionality of the light. Please visit [Sidus.link/app/help](https://Sidus.link/app/help) for more details regarding how to use the app to control your Aputure lights.



Get Sidus Link<sup>®</sup> App



[Sidus.link/app/help](https://Sidus.link/app/help)



# Specifications

<b>Power Input</b>	7W	<b>Power Output</b>	5W
<b>CCT</b>	2000K-10000K	<b>CRI</b>	95
<b>TICI</b>	95	<b>CQS</b>	95
<b>SSI(D32)</b>	82	<b>SSI(D56)</b>	72
<b>TM-30 Rf(avg)</b>	94	<b>TM-30 Rg(avg)</b>	103
<b>Operating Voltage</b>	3.0V-4.2V	<b>Operating Current</b>	0.84A
<b>Operating Temperature</b>	-20°C~+45°C	<b>Charging Time</b>	About 1.5h (USB Type-C 5V/2A)
<b>Battery</b>	3.7V/4200 mAh	<b>Battery Runtime</b>	100% Intensity (5600K): 120 minutes
<b>Control Methods</b>	Manual, Sidus Link® App, DMX/RDM*, Lumenradio® CRMX	<b>Firmware Upgrade Method</b>	Sidus Link
<b>Dimensions (L x W x H)</b>	108*70*25mm/ 4.25*2.76*0.98 in	<b>Weight</b>	247g/0.54 lbs
<b>Cooling Method</b>	Passive	<b>IP Rating</b>	IP65

\* USB-C to 5-Pin XLR In & Out adapter sold separately.

# MC Pro 8-Light Kit

<b>AC Power Input</b>	100 – 240V 50/60Hz	<b>Input Current</b>	1.8A
<b>Input Power (Max)</b>	129W	<b>Output Power (Max)</b>	100W
<b>Battery Requirement</b>	12V – 16.8V	<b>Size</b>	43.5 x 38.5 x 15 cm
<b>Weight (Lamps and Accessories)</b>	9.69 kg	<b>Weight (Net Weight)</b>	5.25kg

\* Single charging slot output: 10 W

\* USB Output: 5V / 2A

# Photometrics

CCT	Distance	Bare Bulb	MC Pro Bubble Diffuser	Dome Diffusers	Flat Diffusers	Light Control Grids
2000K	0.5m	1027 lux	194 lux	253 lux	463 lux	838 lux
2500K	0.5m	1244 lux	226 lux	297 lux	543 lux	1014 lux
3200K	0.5m	1459 lux	262 lux	344 lux	628 lux	1183 lux
4300K	0.5m	1597 lux	291 lux	384 lux	696 lux	1314 lux
5600K	0.5m	1585 lux	297 lux	392 lux	706 lux	1322 lux
6500K	0.5m	1559 lux	295 lux	390 lux	697 lux	1304 lux
7500K	0.5m	1558 lux	291 lux	385 lux	693 lux	1296 lux
8500K	0.5m	1528 lux	289 lux	388 lux	685 lux	1285 lux
10000K	0.5m	1492 lux	283 lux	381 lux	670 lux	1243 lux
R	0.5m	442lux	146lux	175lux	295lux	336lux
G	0.5m	849lux	279lux	329lux	570lux	716lux
B	0.5m	143lux	56lux	63lux	101lux	121lux

*\* This is an averaged result. The luminance of your individual unit may vary slightly from this data.*